



TRIO
LIGHTING FOR YOU



2023

OUTDOOR

AUSSENLEUCHTEN
OUTDOOR LUMINAIRES

power efficiency. We hope you enjoy our new outdoor collection.

Dès que le soleil se couche, un éclairage extérieur innovant est indispensable. Un espace extérieur bien éclairé offre non seulement la sécurité, mais vous aide aussi à vous orienter et crée une agréable ambiance autour de votre maison. Les luminaires extérieurs doivent répondre à des exigences de qualité élevées afin de résister sans dommage aux aléas climatiques telles que l'humidité, la pluie, la neige et les variations saisonnières de température. Nos luminaires d'extérieur

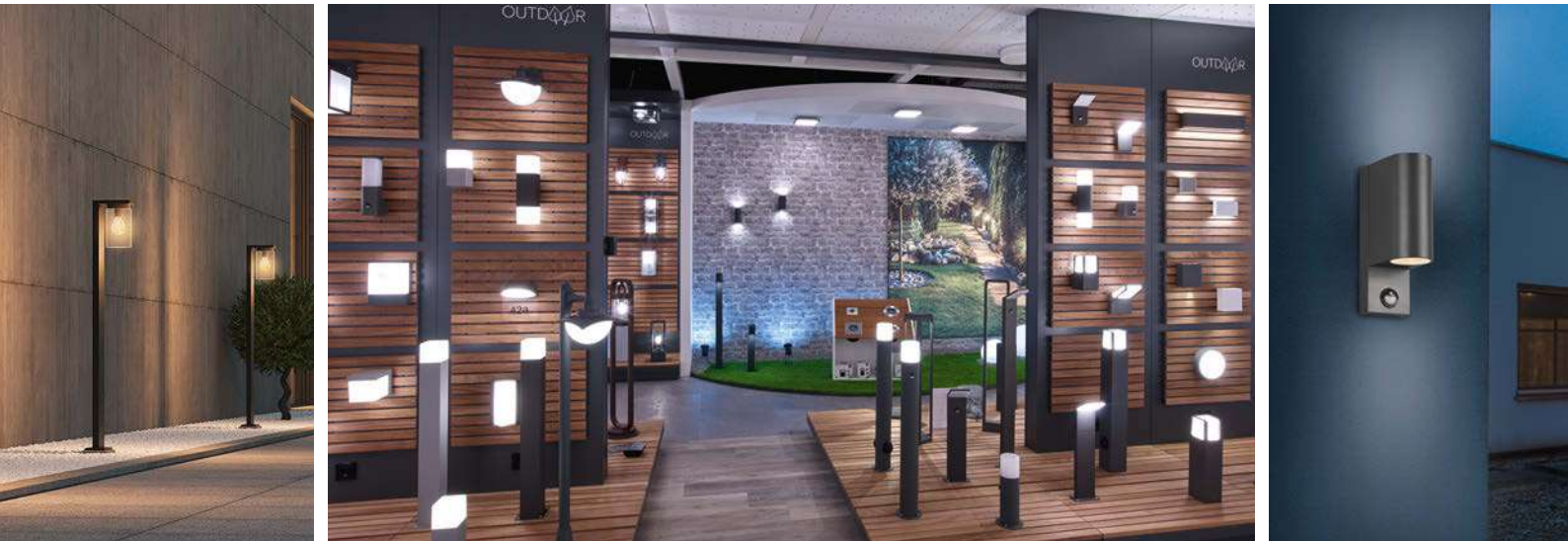

Sobald die Sonne untergeht, darf eine innovative Außenbeleuchtung nicht fehlen. Ein gut beleuchteter Außenbereich bietet nicht nur Sicherheit, sondern dient der Orientierung und schafft Atmosphäre rund um Ihr zu Hause. Außenleuchten sollten hohe Qualitätsanforderungen erfüllen, um den unterschiedlichen Bedingungen wie Feuchtigkeit, Regen, Schnee sowie jahreszeitlich bedingten Temperaturschwankungen unbeschadet standzuhalten. Unsere Außenleuchten werden in hochwertigem Aluminium-Druckguss gefertigt und versprechen Betriebssicherheit während der gesamten Lebensdauer, bei jeder Witterung, 365 Tage im Jahr. Moderne LED-Technologie sorgt darüber hinaus für gute Beleuchtungsqualität und hohe Energieeffizienz. Wir wünschen Ihnen viel Freude mit unser neuen Outdoor-Kollektion.

As soon as the sun goes down innovative outside lighting is a must. Well lit outdoor areas do not only provide security, but are an orientation guide and create atmosphere around your home. Outdoor lighting should fulfil high quality standards to withstand diverse conditions such as dampness, rain, snow and seasonal variations in temperature. Our outdoor lamps are produced in high-quality diecast aluminium and promise operational reliability for their entire life cycle, in all weathers, 365 days a year. Modern LED technology also provides a high level of both light quality and

sont fabriqués en aluminium moulé sous pression de haute qualité et garantissent une sécurité de fonctionnement pendant toute leur durée de vie, par tous les temps, 365 jours par an. La technologie LED moderne assure en outre une bonne qualité d'éclairage et une haute efficacité énergétique. Nous vous souhaitons beaucoup de satisfaction avec notre nouvelle collection d'extérieur.

Zodra de zon ondergaat, mag een innovatieve buitenverlichting niet ontbreken. Een goed verlichte buitenzone biedt niet alleen veiligheid, maar is goed voor de oriëntatie en scheidt sfeer rond uw huis. Buitenlichten moeten voldoen aan hoge kwaliteitsvereisten om bestand te zijn tegen diverse omstandigheden zoals vocht, regen, sneeuw alsook van het seizoen afhingende temperatuurschommelingen. Onze buitenlichten worden uit hoogwaardig aluminium gegoten en beloven een veilige werking tijdens hun volledige levensduur, bij alle weersomstandigheden, 365 dagen per jaar. Moderne ledtechnologie zorgt daarnaast voor een goede verlichtingskwaliteit en hoge energie-efficiëntie. We wensen u veel plezier met onze nieuwe collectie voor buiten.

Tan pronto como se pone el sol, no debe faltar una iluminación exterior innovadora. Una zona exterior bien iluminada no solo ofrece seguridad, sino que también

sirve para orientarse y crean una atmósfera alrededor de tu casa. La iluminación exterior debe cumplir unos altos requisitos de calidad para soportar las diferentes condiciones de humedad, lluvia y nieve, así como las condiciones estacionales de oscilación de temperaturas. Nuestra iluminación exterior está fabricada en aluminio fundido a presión de alta calidad y aseguran la seguridad operativa durante toda su vida, en cualquier clima, 365 días al año. La moderna tecnología LED proporciona también una iluminación de buena calidad y una gran eficiencia energética. Le deseamos una gran satisfacción con nuestra nueva colección de exterior.



și garantează siguranța în operare pe parcursul întregii durate de exploatare, în orice condiții meteo, timp de 365 de zile pe an. Tehnologia LED modernă asigură suplimentar o calitate bună a iluminatului și o eficiență energetică înaltă. Vă dorim să vă bucurați de colecția noastră outdoor.

Kun aurinko laskee, ei innovatiiviseen ulkovalaistukseen pitäisi tarvita puuttua. Hyvin valaistu ulkoalue tarjoaa turvallisuuden lisäksi myös kulkureittien ohjausta ja luo tunnelmaa kodin ympärille. Ulkovalaisimien on täytettävä

Non appena il sole tramonta, l'illuminazione esterna innovativa è un must. Un'area esterna ben illuminata non solo garantisce la sicurezza ma funge anche da mezzo di orientamento e crea una piacevole atmosfera intorno alla vostra casa. Le lampade per esterni devono soddisfare elevati requisiti in termini di qualità per resistere, senza subire danni, alle varie condizioni climatiche come umidità, pioggia, neve e fluttuazioni stagionali della temperatura. Le nostre lampade per esterni sono prodotte in alluminio pressofuso di alta qualità e garantiscono affidabilità operativa durante tutto il loro ciclo di vita, in qualsiasi condizione atmosferica, 365 giorni all'anno. La moderna tecnologia LED garantisce inoltre una buona qualità dell'illuminazione e un'elevata efficienza energetica. Vi auguriamo il massimo del piacere con la nostra nuova Collezione Outdoor.

De îndată ce soarele apune, un sistem inovator de iluminat exterior nu trebuie să lipsească. Un spațiu exterior bine iluminat nu oferă numai securitate, ci are și rolul de a asigura orientarea și de a crea o atmosferă plăcută în jurul casei. Lămpile exterioare trebuie să îndeplinească cerințe înalte de calitate, pentru a rezista fără deteriorări la acțiunea diferitelor condiții de mediu, precum umiditatea, ploaia, ninsoarea, precum și fluctuațiile sezoniere de temperatură. Lămpile noastre exterioare sunt produse din aluminiu turnat sub presiune

korkeat laatuvaatimukset, jotta ne kestävät erilaisia olosuhteita, kuten kosteutta, sadetta, lunta ja vuodenaikojen lämpötilanvaihteluita ilman vaurioita. Ulkovalaisimet valmistetaan korkealaatuisesta painevalelusta alumiinista, ja ne takaavat varman toiminnan koko käyttöikänsä ajan säästä riippumatta, 365 päivää vuodessa. Moderni LED-tekniikka varmistaa myös hyvän valaistuksen laadun ja korkean energiatehokkuuden. Toivomme, että uusi ulkovalaisinmallistomme tuottaa sinulle paljon iloa.

Gdy tylko zachodzi słońce, nie powinno zabraknąć innowacyjnego oświetlenia zewnętrznego. Dobrze oświetlone miejsce na zewnątrz nie tylko zapewnia bezpieczeństwo, ale także służy orientacji w terenie i tworzy atmosferę wokół domu. Oświetlenie zewnętrzne powinno spełniać wysokie wymagania jakościowe, aby bez uszkodzeń sprostać różnym warunkom, tj. wilgoć, deszcz, śnieg i sezonowe wahania temperatury. Nasze lampy zewnętrzne są produkowane z wysokiej jakości odlewanej aluminium i zapewniają niezawodność działania przez cały okres użytkowania, bez względu na pogodę, 365 dni w roku. Nowoczesna technologia LED zapewnia również dobrą jakość oświetlenia i wysoką efektywność energetyczną. Życzymy Państwu wiele radości z korzystania z naszej nowej kolekcji oświetlenia zewnętrznego.

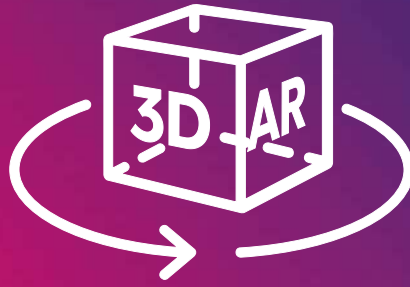

3D und AR – entdecken Sie unsere Leuchten aus einem neuen Blickwinkel!

3D and AR – 3D and AR - Discover our luminaires from a new angle!

Augmented Reality – mit dem Smartphone oder Tablet direkt in Ihr Zuhause!

Augmented Reality – kurz AR – steht für „erweiterte Realität“. Durch unsere moderne AR-Funktion können Sie die „reale Welt“ mit unseren virtuellen Leuchten verbinden und diese bereits vorab digital in 3D in Ihrem Zuhause ausprobieren. Platzieren Sie die ausgewählte Leuchte virtuell an Ihrem gewünschten Ort und machen Sie sich ein Bild davon, ob z.B. die Stehleuchte zu Ihrem Wohnkonzept passt. Wie unsere AR-Funktion funktioniert? Ganz simpel ohne App und ohne großen Aufwand! Zum Ausspielen unserer digitalen Leuchte benötigen Sie ein Smartphone oder ein Tablet mit einer Kamera. Bei dem gewünschten Produkt finden Sie einen QR-Code, den Sie mit Ihrer Kamera einscannen. Nachdem Sie dem QR-Code-Link gefolgt sind und Ihre Umgebung anhand Ihrer Kamera erfasst wurde, wird Ihnen die gewünschte Leuchte dreidimensional in Ihren eigenen vier Wänden angezeigt. Nun können Sie unser Produkt detailliert und von allen Blickwinkeln an Ihrem Wunschort betrachten. Überzeugen Sie sich spätestens jetzt von unseren Leuchten!

Augmented Reality - get a feeling of our luminaires in your home using your smartphone or tablet

Augmented Reality - AR for short - allows you to extend the boundaries of reality. Thanks to our modern AR function, you can connect the „real world“ to our virtual luminaires and try them digitally in 3D in your home before you buy them. Place the selected luminaire virtually in your desired location and get an idea of whether, for example, the floor lamp fits your living concept.

Curious how our AR function works? To put it in simple words: without any app and without much effort! To see our digital luminaires, all you need is a smartphone or tablet with a camera. At the desired product you will find a QR code that you scan with your camera. After you have followed the QR code link and once your surroundings have been captured using your camera, the luminaire of your choice will be displayed three-dimensionally in your own place. This lets you view our product in detail and from all angles at your desired location. Convince yourself of our luminaires right now!



Mit der 3D-Funktion auf Herz und Nieren prüfen

Durch unsere dreidimensionale Funktion können Sie unsere Leuchten realitätsnah von allen Seiten betrachten und sich ein eigenes Bild zu unserem Sortiment machen. Entdecken Sie die filigranen Details unserer Produkte schnell und simpel mit wenigen Klicks.

Putting it through its paces using the 3D function

Thanks to our three-dimensional function, you can view our luminaires realistically from all sides and shape your own impression of the product range we offer. Discover the intricate details of our products quickly and easily with just a few clicks.



Realità aumentata - per provare la sensazione delle nostre lampade nella tua casa usando il tuo smartphone o tablet

La realtà aumentata - AR in breve - permette di estendere i confini della realtà. Grazie alla nostra moderna funzione AR, puoi collegare il „mondo reale“ alle nostre lampade virtuali e provarle digitalmente in 3D nella tua casa prima di acquistarle. Posiziona virtualmente la lampada scelta nella posizione desiderata e fatti un'idea se, per esempio, la lampada a piantana, si adatta al tuo concetto abitativo.

Curioso di sapere come funziona la nostra funzione AR? In parole povere: senza alcuna app e senza molto sforzo! Per vedere le nostre lampade digitali, tutto ciò che serve è uno smartphone o un tablet con una fotocamera. Sul prodotto desiderato troverai un codice QR da scansionare con la tua fotocamera. Dopo aver seguito il link del codice QR e una volta che l'ambiente circostante è stato catturato con la fotocamera, l'apparecchio di illuminazione di tua scelta sarà visualizzato tridimensionalmente nel tuo ambiente. Questo ti permette di vedere il nostro prodotto in dettaglio e da tutte le angolazioni nel luogo che desideri. Convinciti subito delle nostre lampade!

Réalité augmentée - Ayez un avant-goût de nos luminaires chez vous à l'aide de votre smartphone ou de votre tablette

La Réalité Augmentée - RA en abrégé - vous permet de repousser les frontières de la réalité. Grâce à notre fonction moderne de réalité augmentée, vous pouvez vous connecter le « monde réel » à nos luminaires virtuels et les essayer numériquement en 3D chez vous avant de les acheter. Placez le luminaire sélectionné virtuellement dans l'endroit souhaité et faites-vous une idée de si, par exemple, le lampadaire s'intègre à votre salon.

Curieux de savoir comme notre RA fonctionne ? Pour le dire simplement : sans application et sans trop d'effort ! Pour voir nos luminaires numériques, tout ce dont vous avez besoin c'est d'un smartphone ou d'une tablette avec appareil photo. Sur le produit souhaité, vous trouverez un QR code que vous scannez avec votre appareil photo. Après avoir suivi le lien du QR code et une fois que vos environnements ont été capturés à l'aide de votre appareil photo, le luminaire de votre choix sera affiché en trois dimensions dans votre propre endroit. Cela vous permet de voir notre produit en détail et depuis tous les angles dans l'endroit souhaité. Laissez-vous tout de suite séduire par nos luminaires!

Augmented Reality - krijg een idee over onze lampen in uw huis via uw smartphone of tablet

Augmented Reality - AR afgekort - staat u toe de grenzen van de realiteit te verlengen. Dankzij onze moderne AR-functie kunt u de „echte wereld“ verbinden met onze virtuele lampen en ze digitaal in 3D uitproberen bij u thuis voordat u ze koopt. Plaats de geselecteerde lamp virtueel op uw gewenste locatie and krijg een idee of bijvoorbeeld de staande lamp past binnen uw leefconcept.

Benieuwd hoe onze AR-functie werkt? Om het eenvoudig te stellen: zonder app en zonder veel moeite! Al wat u nodig hebt om onze digitale lampen te bekijken, is een smartphone of tablet met een camera. Bij het gewenste product vindt u een QR-code die u met uw camera scant. Nadat u de QR-code link gevolgd hebt en eens uw omgeving via uw camera vastgelegd werd, wordt de lamp van uw keuze driedimensionaal in uw eigen ruimte weergegeven. Dit laat u ons product in detail en vanuit alle hoeken op uw gewenste locatie bekijken. Overtuig uzelf nu van onze lampen!

Realidad aumentada: hágase a la idea de cómo quedan nuestras lámparas en su hogar mediante su teléfono inteligente o su tableta

La realidad aumentada le permite ampliar los límites de la realidad. Gracias a nuestra moderna función de realidad aumentada, tiene la posibilidad de conectar nuestras lámparas virtuales con el „mundo real“ y probarlas de manera digital en 3D en su hogar antes de comprarlas. Coloque virtualmente la lámpara seleccionada en la ubicación deseada y compruebe si, por ejemplo, una lámpara de pie encaja con la estética de su salón.

¿Cómo funciona nuestra función de realidad aumentada? En unas sencillas palabras: sin requerir ninguna aplicación ni esfuerzo. Lo único que necesita para ver nuestras lámparas es un teléfono inteligente o una tableta con cámara. El producto que seleccione contará con un enlace de código QR que puede escanear con su cámara. Después de acceder al enlace del código QR y una vez que haya capturado el entorno con la cámara, se mostrará la lámpara seleccionada en tres dimensiones en su propio hogar. Esto le permite ver nuestros productos al detalle y desde todos los ángulos en la ubicación que desee. Convéngase de elegir nuestras lámparas usted mismo.

Realitatea augmentată - faceți-vă o idee despre corpurile noastre de iluminat în căminul dvs., folosind un smartphone sau o tabletă

Realitatea augmentată - AR, pe scurt - vă permite să extindeți limitele realității. Datorită funcției AR moderne, puteți conecta „lumea reală” la corpurile noastre de iluminat virtuale și le puteți testa digital în format 3D acasă, înainte de a le cumpăra. Amplasați virtual corpul de iluminat selectat în locul dorit și vedeți aproximativ, de exemplu, dacă lampadarul se potrivește în conceptul camerei de zi.

Sunteți curioși să știți cum funcționează AR? Pe scurt: fără nicio aplicație și fără prea mult efort! Pentru a vedea corpurile noastre de iluminat digitale aveți nevoie doar de un smartphone sau o tabletă cu cameră. La produsul dorit găsiți un cod QR pe care îl scanați cu camera. După ce accesați linkul de la codul QR și după ce sunt înregistrate împrejurimile folosind camera, corpul de iluminat selectat este afișat tridimensional în propria dvs. locuință. Astfel puteți vedea produsul în detaliu, din toate unghiurile, în locul ales de dvs. Convingeți-vă chiar acum în legătură cu corpurile noastre de iluminat!

Lisätty todellisuus - kokeile valaisimiamme kotonasi älypuhelimien tai tabletin avulla

Lisätty todellisuus - lyhennettynä AR (augmented reality) - antaa mahdollisuuden laajentaa todellisuuden rajoja. Nykyaikaisen AR-toimintomme ansiosta voit yhdistää „oikean maailman” virtuaalivalaisimiimme ja kokeilla niitä digitaalisesti 3D:nä kotonasi ennen ostopäätöstä. Aseta valitut valaisimet virtuaalisesti haluttuun paikkaan ja saat suuripiirteisen kuvan siitä, sopiiko esimerkiksi lattialamppu olohuoneeseen.

Kiinnostaako, kuinka AR-toimintomme toimii? Yksinkertaistetusti: ilman sovelluksia ja turhaa vaivannäköä! Nähdäksesi valaisimemme tarvitset ainoastaan kamerallisen älypuhelimien tai tabletin. Halutun tuotteen kohdalta löydät QR-koodin, jonka voit lukea kamerallasi. Kun olet seurannut QR-koodin linkkiä ja kun ympäristösi on tallennettu kameraasi käyttäen, haluamasi valaisin näkyy kolmiulotteisena omassa kodissasi. Näin pystyt tutustumaan tuotteisiimme yksityiskohtaisesti ja kaikista vinkkeleistä haluamassasi paikassa. Anna valaisimiemme vakuuttaa sinut!

Rozszerzona rzeczywistość – zobacz nasze oprawy w swoim domu za pomocą smartfona lub tablety

Rozszerzona rzeczywistość (augmented reality – AR) pozwala poszerzać granice rzeczywistości. Dzięki naszej nowoczesnej funkcji AR możesz połączyć rzeczywisty świat z naszymi wirtualnymi oprawami i wypróbować je cyfrowo w 3D w swoim domu, zanim je kupisz. Umieść oprawę wirtualnie w wybranym miejscu i przekonaj się, czy np. lampa podłogowa pasuje do Twojej koncepcji mieszkania.

Ciekawi Cię, jak działa nasza funkcja AR? Krótko mówiąc: bez żadnej aplikacji i bez większego wysiłku! Aby zobaczyć nasze cyfrowe oprawy, wystarczy smartfon lub tablet z aparatem. Przy wybranym produkcie znajdziesz kod QR, który zeskanujesz aparatem. Po kliknięciu linku z kodem QR i uchwyceniu otoczenia za pomocą aparatu, wybrana przez Ciebie oprawa zostanie wyświetlona w trzech wymiarach w Twoim pokoju. Dzięki temu możesz obejrzeć nasz produkt szczegółowo i pod każdym kątem w wybranym miejscu. Przekonaj się już teraz o naszych oprawach!

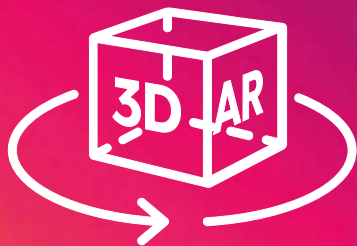

3D et AR - Découvrez nos luminaires depuis un nouvel angle!

3D en AR - Ontdek onze lampen vanuit een nieuwe hoek!

3D y realidad aumentada: descubra nuestras lámparas con una nueva perspectiva.

3D e AR - Scopri le nostre lampade da una nuova angolazione!

3D și AR - Descoperiți corpurile noastre de iluminat dintr-un alt unghi!

3D ja AR - Tutustu valaisimiimme uudesta vinkkelistä!

3D i AR – Odkryj nasze oprawy z nowej perspektywy!

Mise à l'épreuve à l'aide de la fonction 3D

Grâce à notre fonction à trois dimensions, vous pouvez voir nos luminaires de façon réaliste de tous les côtés et vous faire votre propre idée de la gamme de produits que nous proposons. Découvrez rapidement et facilement les détails complexes de nos produits en seulement quelques clics.

Het grondig testen via de 3D-functie

Dankzij onze driedimensionale functie kunt u onze lampen realistisch bekijken van alle gezichtspunten en uw eigen indruk vormen van het productgamma dat we aanbieden. Ontdek snel en makkelijk de complexe details van onze producten via slechts enkele malen klikken.

Póngalas a prueba con las funciones 3D

Gracias a nuestra función tridimensional, puede tener una visualización realista de nuestras lámparas desde todos los ángulos y hacerse una idea propia de la gama de productos que ofrecemos. Descubra los intrincados detalles de nuestros productos de forma rápida y sencilla en solo unos clics.

Mettila alla prova con la funzione 3D

Grazie alla nostra funzione tridimensionale, puoi osservare le nostre lampade in modo realistico da tutti i lati e farti un'idea personale della gamma di prodotti che offriamo. Scopri i dettagli intricati dei nostri prodotti in modo rapido e semplice con pochi clic.

Inițierea folosind funcția 3D

Datorită funcției tridimensionale, puteți vedea corpurile noastre de iluminat în mod realist, din toate unghiurile, și vă puteți crea propria impresie în legătură cu gama de produse de produse oferită. Descoperiți detaliile complexe ale produselor noastre rapid și facil, cu doar câteva clicuri.

Vauhtia 3D-toiminnon avulla

Kolmiulotteisen toimintomme avulla näet valaisimemme todenmukaisesti kaikilta puolilta ja voit muovata oman mielipiteesi tarjoamastamme tuotevalikoimasta. Tutustu tuotteidemme kiehtoviin yksityiskohtiin nopeasti ja vaivattomasti muutamalla klikkauksella.

Przetestuj za pomocą funkcji 3D

Dzięki funkcji 3D możesz realistycznie oglądać nasze oprawy ze wszystkich stron i kształtować własne wrażenie z oferowanego przez nas asortymentu. Sprawdź szczegóły naszych produktów szybko i łatwo za pomocą kilku kliknięć.



LENNOR
R52176102

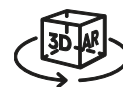

FUERTE
526260142





Serienübersicht · Family overview

Aperçu par famille · Overzicht per familie · Vista general por familia · Panoramica per famiglia ·
Prezentare pe familii de produse · Perheen yleiskuvaus · Przegląd rodziny



| | | | | | |
|----------|-----|------------|-----|-----------|-----|
| ADAJA | 60 | ROYA | 46 | ARUBA | 156 |
| ARDAS | 61 | SACRAMENTO | 62 | BOLO | 160 |
| ARDILA | 88 | SAMBESI | 112 | CAMARO | 144 |
| AVON | 18 | SHANNON | 32 | CAMPUS | 183 |
| BELAJA | 126 | TANARO | 118 | CARMO | 164 |
| BELLY | 52 | TAWA | 53 | CORDOBA | 136 |
| BREG | 84 | TAY | 59 | CORO | 180 |
| BRENTA | 122 | THAMES | 55 | COTOCA | 177 |
| CANNING | 104 | THAMES II | 56 | DORA | 158 |
| CAVADO | 116 | TIBER | 72 | ELLIOT | 154 |
| CLYDE | 73 | TIMOK | 82 | ESQUEL | 168 |
| COLORADO | 54 | TRAVE | 64 | FERNANDEZ | 153 |
| COOPER | 102 | TRENT | 58 | FOMOSA | 170 |
| CUANDO | 68 | TUELA | 120 | GARCIA | 173 |
| CUBANGO | 98 | TUNGA | 74 | JAMAICA | 157 |
| DUERO | 125 | UBANGI | 128 | KENDAL | 142 |
| FUERTE | 22 | WITHAM | 66 | LAREDO | 135 |
| GANGES | 28 | YANGTZE | 70 | LENNON | 155 |
| GARONNE | 106 | | | LIMEIRA | 139 |
| HONDO | 83 | | | LOJA | 181 |
| HOOSIC | 90 | | | LORA | 159 |
| HORTON | 42 | | | MAIRANA | 176 |
| HUDSON | 96 | | | MARTINEZ | 152 |
| INDUS | 69 | | | MELO | 182 |
| KASAI | 81 | | | MENDOZA | 170 |
| KAVERI | 50 | | | MERIDA | 179 |
| KONDA | 63 | | | MINEROS | 174 |
| LOGONE | 24 | | | MOLINA | 138 |
| LUNGA | 110 | | | MORENA | 141 |
| MAREB | 129 | | | PALMAS | 148 |
| MERSEY | 79 | | | POSADAS | 166 |
| MITCHELL | 71 | | | PUELO | 145 |
| MUGA | 78 | | | PUNO | 134 |
| NELSON | 38 | | | ROSARIO | 137 |
| NESTOS | 16 | | | SANCHEZ | 150 |
| NORMAN | 100 | | | SALTA | 171 |
| OHIO | 65 | | | SANTANA | 175 |
| OLONA | 124 | | | SILVA | 172 |
| PEARL | 34 | | | SONORA | 178 |
| PECOS | 80 | | | VENADO | 140 |
| PEDRO | 85 | | | | |
| PIAVE | 86 | | | | |
| RENO | 26 | | | | |
| RHINE | 30 | | | | |

Produktübersicht · Product Overview

Aperçu des produits · Productoverzicht · Descripción del producto ·

Panoramica prodotto · Vizualizare produs · Tuotteen yleiskuvaus · Przegląd produktów



AVON
20



FUERTE
22



RHINE
30



WITHAM
66



SHANNON
32



NELSON
40



GANGES
28



PEARL
36



TAWA
51



NESTOS
16



YANGTZE
70



CUANDO
68



HORTON
44



TRAVE
64



THAMES
55



THAMES II
56



TRENT
58



LOGONE
24



COLORADO
54



TAY
59



SACRAMENTO
62



RENO
26



COOPER
102



CLYDE
73



ROYA
48



TIBER
72



KAVERI
50



TUNGA
76



ADAJA
60



CORDOBA
136



ROSARIO
137



ARDAS
61



PUNO
134



ARDILA
88



HOOSIC
94



HUDSON
96



MOLINA
138



MOLINA
138



MITCHELL
71



INDUS
69



TIMOK
82



PECOS
80



MUGA
78



PEDRO
85



KONDA
63



KENDAL
142



BELLY
52



HONDO
83



TRAVE
64



BREG
84



KENDAL
142



CAMARO
144



VENADO
140



MORENA
141



CUBANGO
98



TUELA
120



CANNING
104



GARONNE
106



GARONNE
108

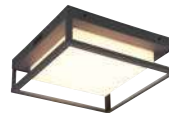

WITHAM
66



SAMBESI
112



TANARO
118



LUNGA
110



OLONA
124



CAVADO
116



DUERO
125



BRENTA
122



BRENTA
123



AVON
20



NESTOS
16



FUERTE
22



RHINE
30



PEARL
36



ROYA
48



NELSON
40



HORTON
44



KAVERI
50



LOGONE
24



GANGES
28



RENO
26



COOPER
102



ARDILA
88



SHANNON
32



WITHAM
66



HOOSIC
94



HUDSON
96



CANNING
104



GARONNE
106



SAMBESI
112



TANARO
118



CUBANGO
98



TUELA
120



CAVADO
116

Sicherheit & Komfort / Sensorleuchten · Security & Comfort / Sensor Lights

Sécurité et confort / Lampes à détecteur · Veiligheid en comfort/sensorklampen · Seguridad & Comodidad / Luces del sensor ·
Sicurezza e comfort / Lampade con sensore integrat · Siguranță & confort / Lumini senzori ·
Turvallisuus ja mukavuus/tunnistinvalaisimet · Bezpieczeństwo i komfort / światła z czujnikami



AVON
18



NESTOS
16



RHINE
30



GANGES
29



NELSON
38



PEARL
34



HORTON
42



ROYA
46



ROYA
46



TUNGA
74



TUNGA
74



CUANDO
68



OHIO
65



HOOSIC
92



HOOSIC
92



NORMAN
100



KASAI
81



PIAVE
86



AVON
18



ROYA
46



HORTON
42



PEARL
34



NELSON
38



HOOSIC
92



SAMBESI
115



CAVADO
116



TUELA
121



LUNGA
111



LUNGA
110



LAREDO
135



MERSEY
79

Spots, Einbauleuchten & Zubehör ·

Spotlights, Recessed luminaires & Accessories

Spots, lumières encastrées et accessoires · Spots, inbouwlampen en toebehoren · Puntos de luz, lámparas integradas y accesorios · Faretto, lampade da incasso e sensori · Spoturi, lămpi încorporate & accesorii · Kohdevalaisimet, upotettavat valaisimet ja tarvikkeet · Spoty, światła wpuszczane i akcesoria



TUNGA
74



BELAJA
127



BELAJA
126



MAREB
129



UBANGI
128



ERDSPIESS
GROUND SPIKE
132



ECKHALTERUNG
CORNER FASTENING
133



STECKDOSEN
PLUG
130



STECKDOSEN
PLUG
130



STECKDOSEN
PLUG
131

Outdoor Living · Outdoor Living Lighting

Idées d'éclairage pour la vie en plein air · Lichtideeën voor buiten · Ideas de luz para la vida al aire libre · Idee di Illuminazione per l'Outdoor Living · Idei de iluminare pentru exterior · Outdoor Living -valaisinideat · Pomysły na oświetlenie zewnętrzne



ARUBA
156



JAMAICA
157



PALMAS
148



DORA
158



LORA
159



ELLIOT
154



LENNON
155



SANCHEZ
151



FERNANDEZ
153



MARTINEZ
152



BOLO
160

Solarleuchten · Solar Lights

Lampes solaires · Lampen op zonne-energie · Luces solares · Lampade solari · Lāmpi solare · Aurinkovalaisimet · Światła z zasilaniem słonecznym



CARMO
164



POSADAS
166



ESQUEL
168



MENDOZA
170



FOMOSA
170



SALTA
171



CARMO
164



POSADAS
166



ESQUEL
168



SILVA
172



GARCIA
173



MINEROS
174



CORO
180



LOJA
181



MAIRANA
176



COTOCA
177



SANTANA
175



SONORA
178



MERIDA
179



MERIDA
179



MELO
182



CAMPUS
183

NESTOS

Aluminium Druckguss, Kunststoff
 diecast aluminium, plastic
 fonte d'aluminium, plastique
 gegoten aluminium, kunststof
 aluminio fundido, plástico
 pressofusione di alluminio, plastica
 fonta aluminiu, plastic
 valualumiini, muov
 barwione aluminium, plastik

42 Anthrazit · anthracite

Incl. 1 x SMD-LED, 13 W
 1.300 lm, 3.000 K

240960142

IP54

Incl. 1 x SMD-LED, 13 W
 1.300 lm, 3.000 K

240969142

440969142

540969142

IP54



240960142



240969142



440969142



540969142

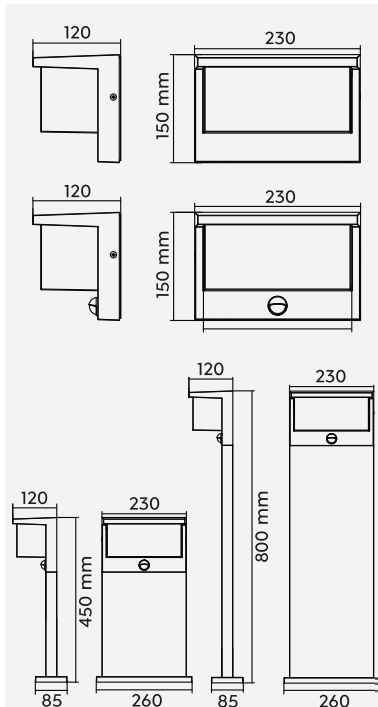

max.
 8m/120°

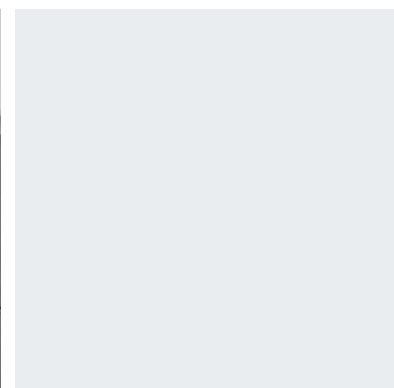



AVON

Aluminium Druckguss, Acryl
 diecast aluminium, acryl
 fonte d'aluminium, acryl
 gegoten aluminium, acryl
 aluminio fundido, acrílico
 pressofusione di alluminio, acrilico
 fonta aluminiu, acrilic
 valualumiini, akryyli
 barwione aluminium, akryl

42 Anthrazit · anthracite

Incl. 1 x SMD-LED, 7 W
 800 lm, 3.000 K

270669142

470669142

570669142



Incl. 2 x SMD-LED, 7 W
 2 x 800 lm, 3.000 K

270669242



270669142

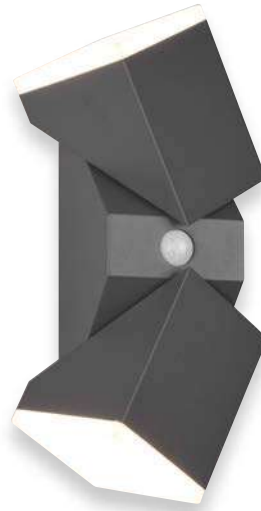

270669242



570669142



470669142

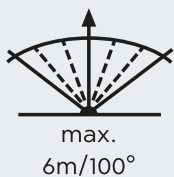
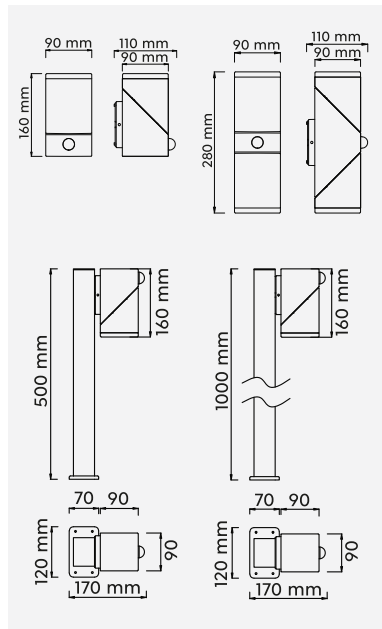



Die Leuchte verfügt über ein Orientierungslicht, das sich bei Dämmerung oder Dunkelheit automatisch einschaltet. Wird eine Bewegung erfasst, schaltet die Leuchte von Orientierungslicht auf volle Lichtleistung.

The luminaire has an orientation light that switches on automatically at dusk or in the dark. If movement is detected, the luminaire switches from orientation light to full light output.

AVON

Aluminium Druckguss, Acryl
 diecast aluminium, acryl
 fonte d'aluminium, acryl
 gegoten aluminium, acryl
 aluminio fundido, acrílico
 pressofusione di alluminio, acrilico
 fonta aluminii, acrilic
 valualumiini, akryyli
 barwione aluminium, akryl

42 Anthrazit · anthracite

Incl. 1 x SMD-LED, 7 W
 800 lm, 3.000 K

270660142

470660142

570660142



Incl. 2 x SMD-LED, 7 W
 2 x 800 lm, 3.000 K

270660242



270660142



270660242



570660142



470660142

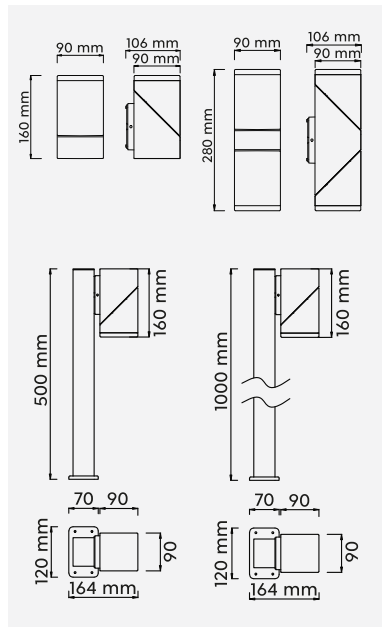



FUERTE

Aluminium Druckguss, Acryl
diecast aluminium, acryl
fonte d'aluminium, acryl
gegoten aluminium, acryl
aluminio fundido, acrílico
pressofusione di alluminio, acrilico
fonta aluminiu, acrilic
valualumiini, akryyli
barwione aluminium, akryl

42 Anthrazit · anthracite

Incl. 1 x SMD-LED, 10,5 W
1.300 lm, 3.000 K

226260142

IP54

Incl. 1 x SMD-LED, 15 W
1.700 lm, 3.000 K

426260142

526260142

IP54



226260142



426260142



526260142

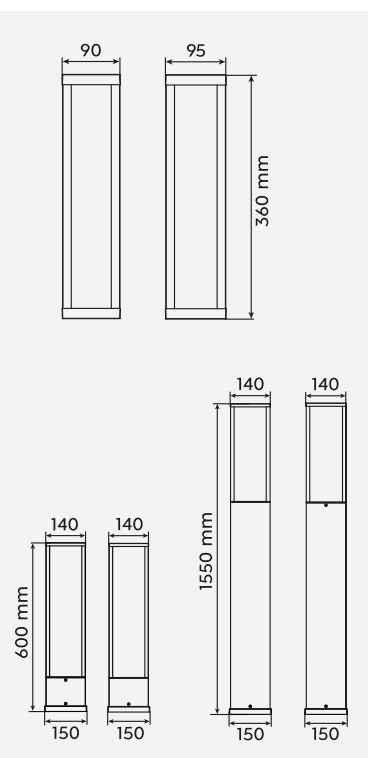



222

LOGONE

Aluminium Druckguss
diecast aluminium
fonte d'aluminium
gegoten aluminium
aluminio fundido
pressofusione di alluminio
fonta aluminiu
valualumiini
barwione aluminium

42 Anthrazit · anthracite

Incl. SMD-LED, 11 W
1.100 lm, 3.000 K

IP65

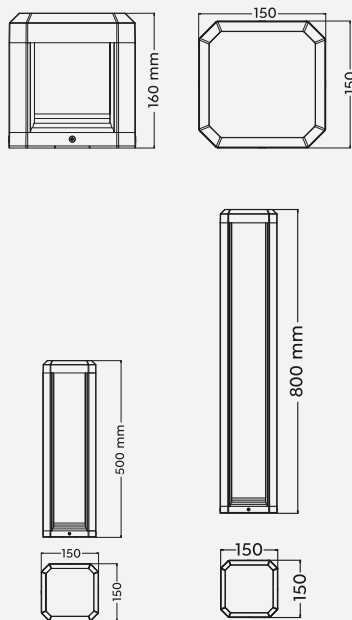

222360142



522360142



422360142

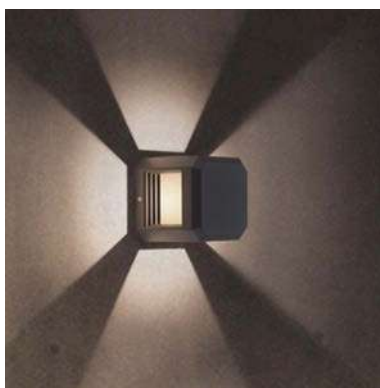



RENO

Aluminium Druckguss
diecast aluminium
fonte d'aluminium
gegoten aluminium
aluminio fundido
pressofusione di alluminio
fonta aluminu
valualumiini
barwione aluminium

42 Anthrazit · anthracite

Incl. 1 x COB-LED, 4,5 W
450 lm, 3.000 K

IP54

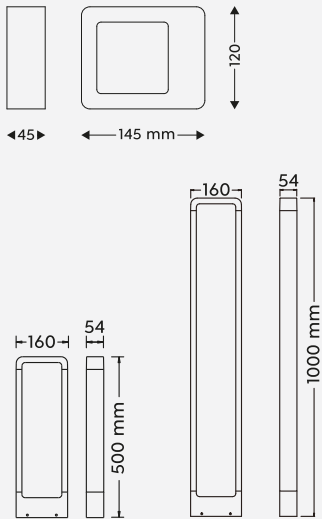

220760142



520760142

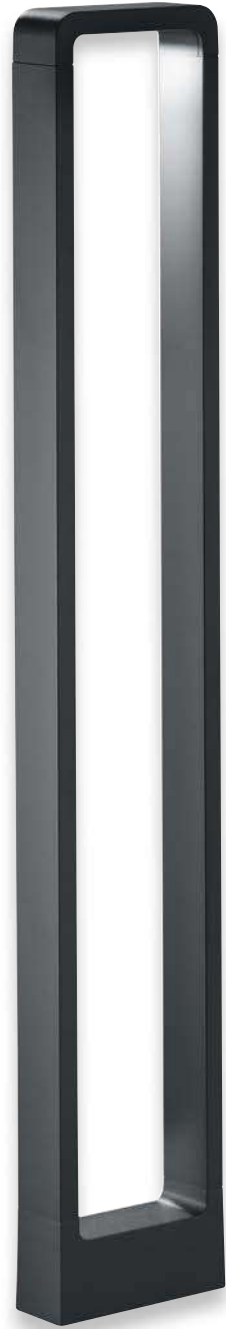

420760142

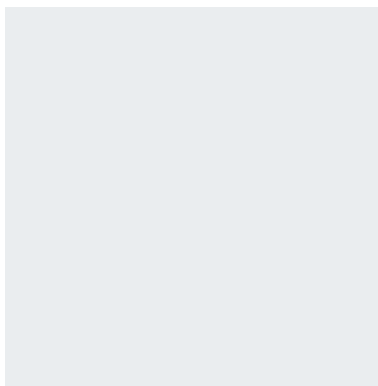



GANGES

Aluminium Druckguss
diecast aluminium
fonte d'aluminium
gegoten aluminium
aluminio fundido
pressofusione di alluminio
fonta aluminii
valualumiini
barwione aluminium

42 Anthrazit · anthracite

Incl. 1 x SMD-LED, 9 W
1.000 lm, 3.000 K

IP54

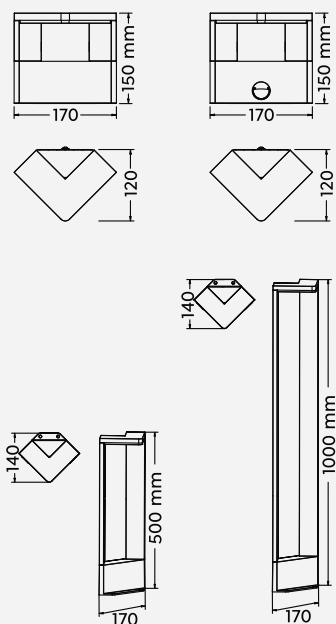

221760142



521760142



421760142





221769142



Bewegungssensor
Motion sensor
Détecteur de mouvement
Bewegingssensor
Sensor de movimiento
Sensore di movimento
Senzor de mișcare
Liiketunnistin
Czujnik ruchu

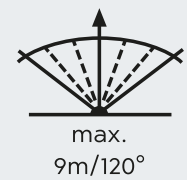

RHINE

Aluminium Druckguss, Kunststoff
 diecast aluminium, plastic
 fonte d'aluminium, plastique
 gegoten aluminium, kunststof
 aluminio fundido, plástico
 pressofusione di alluminio, plastica
 fonta aluminiu, plastic
 valualumiini, muovi
 barwione aluminium, plastik

42 Anthrazit · anthracite

Incl. 2 x SMD-LED, 4,5 W
 2 x 600 lm, 3.000 K

221660242

221669242

Incl. 2 x SMD-LED, 5,5 W
 2 x 700 lm, 3.000 K

421660242

521660242

IP54



221669242



221660242



521660242



421660242

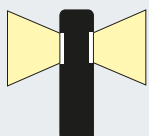
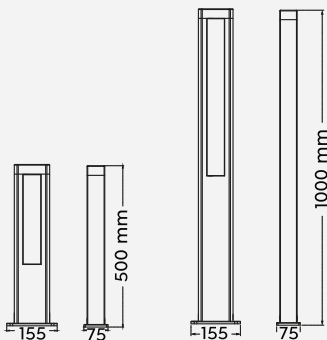
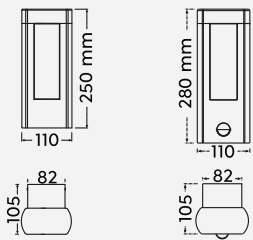



Bewegungssensor
Motion sensor
Détecteur de mouvement
Bewegungssensor
Sensor de movimiento
Sensore di movimento
Senzor de mișcare
Liiketunnistin
Czujnik ruchu

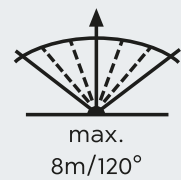

SHANNON

Aluminium Druckguss, Kunststoff
diecast aluminium, plastic
fonte d'aluminium, plastique
gegoten aluminium, kunststof
aluminio fundido, plástico
pressofusione di alluminio, plastica
fonta aluminiu, plastic
valualumiini, muovi
barwione aluminium, plastik

42 Anthrazit · anthracite

Incl. 1 x SMD-LED, 7,2 W
660 lm, 3.000 K

IP54

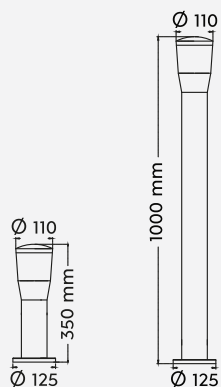
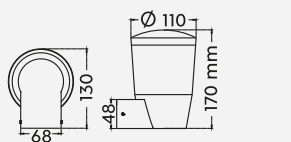

222060142



522060142



422060142

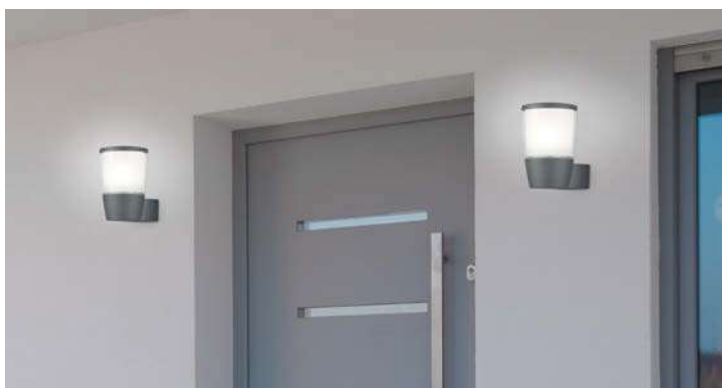



PEARL

Aluminium Druckguss, Kunststoff
 diecast aluminium, plastic
 fonte d'aluminium, plastique
 gegoten aluminium, kunststof
 aluminio fundido, plástico
 pressofusione di alluminio, plastica
 fonta aluminiu, plastic
 valualumiini, muov
 barwione aluminium, plastik

42 Anthrazit · anthacite

Incl. 1 x SMD-LED, 8 W
 900 lm, 3.000 K



221169142



521169142



421169142

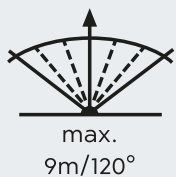
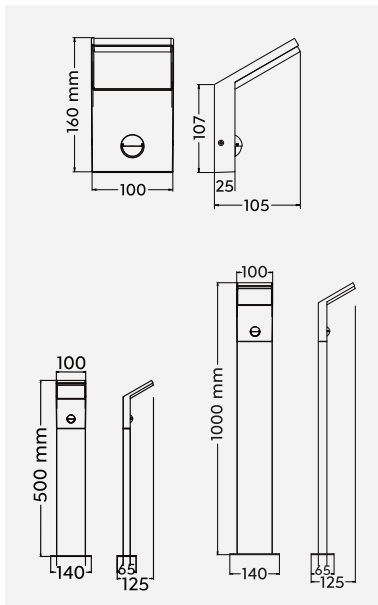

Bewegungssensor
 Motion sensor
 Détecteur de mouvement
 Bewegungssensor
 Sensor de movimiento
 Sensore di movimento
 Senzor de mişcare
 Liiketunnistin
 Czujnik ruchu





PEARL

Aluminium Druckguss, Kunststoff
diecast aluminium, plastic
fonte d'aluminium, plastique
gegoten aluminium, kunststof
aluminio fundido, plástico
pressofusione di alluminio, plastica
fonta aluminiu, plastic
valualumiini, muovi
barwione aluminium, plastik

42 Anthrazit · anthacite

Incl. 1 x SMD-LED, 8 W
900 lm, 3.000 K

IP54

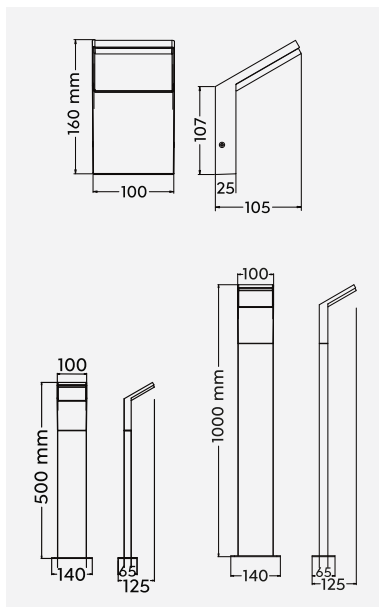

221160142



521160142



421160142





NELSON

Aluminium Druckguss
diecast aluminium
fonte d'aluminium
gegoten aluminium
aluminio fundido
pressofusione di alluminio
fonta aluminiu
valualumiini
barwione aluminium

42 Anthrazit · anthracite

Incl. 1 x SMD-LED, 8 W
900 lm, 3.000 K

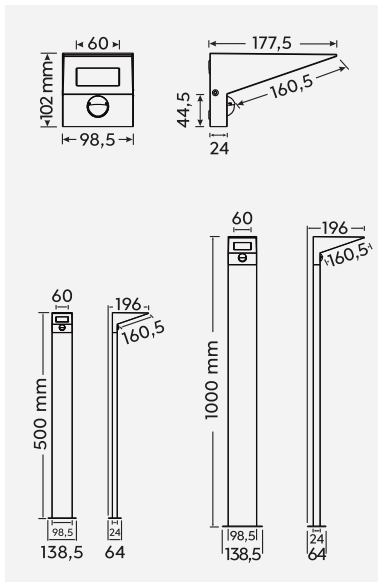

525369142



425369142





225369142



Bewegungssensor
Motion sensor
Détecteur de mouvement
Bewegungssensor
Sensor de movimiento
Sensore di movimento
Senzor de mișcare
Liiketunnistin
Czujnik ruchu

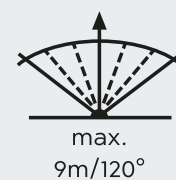

max.
9m/120°

NELSON

Aluminium Druckguss
diecast aluminium
fonte d'aluminium
gegoten aluminium
aluminio fundido
pressofusione di alluminio
fonta aluminiu
valualumiini
barwione aluminium

42 Anthrazit · anthracite

Incl. 1 x SMD-LED, 8 W
900 lm, 3.000 K

IP54

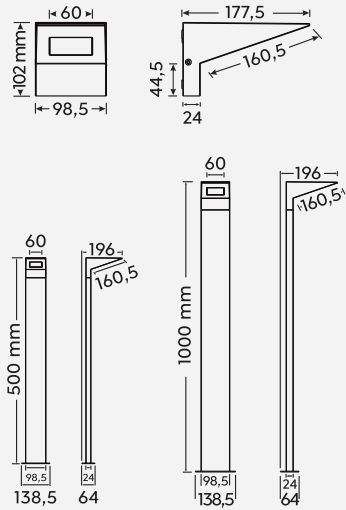

225360142



525360142



425360142





HORTON

Aluminium Druckguss
 diecast aluminium
 fonte d'aluminium
 gegoten aluminium
 aluminio fundido
 pressofusione di alluminio
 fonta aluminiu
 valualumiini
 barwione aluminium

42 Anthrazit · anthracite

Incl. 1 x SMD-LED, 8 W
 1.000 lm, 3.000 K

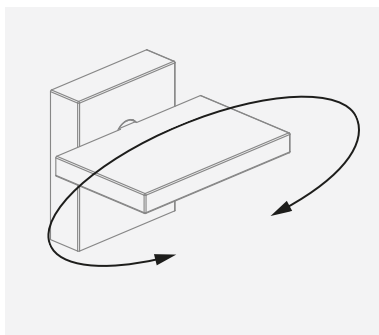
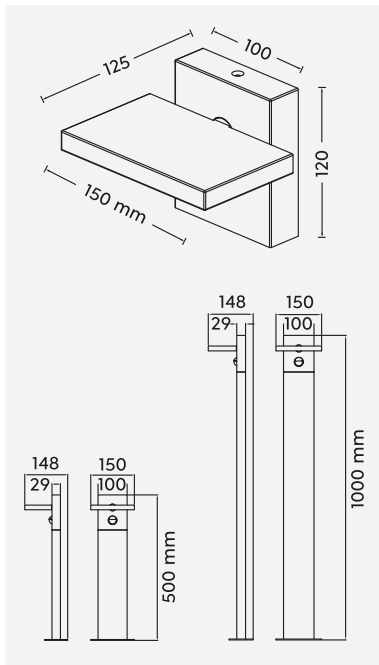

226369142



526369142

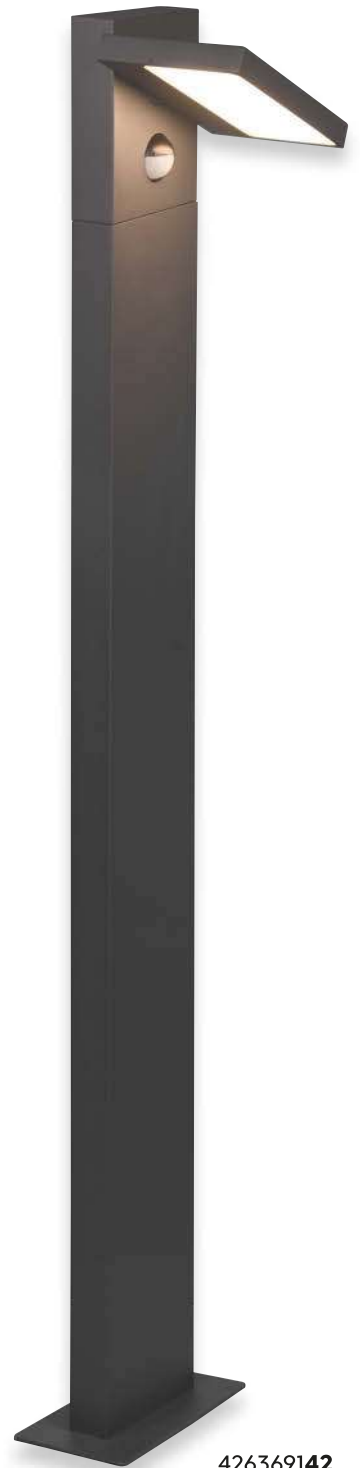

426369142



Bewegungssensor
 Motion sensor
 Détecteur de mouvement
 Bewegungssensor
 Sensor de movimiento
 Sensore di movimento
 Senzor de mişcare
 Liiketunnistin
 Czujnik ruchu

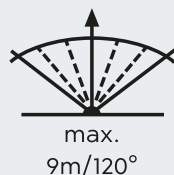



HORTON

Aluminium Druckguss
 diecast aluminium
 fonte d'aluminium
 gegoten aluminium
 aluminio fundido
 pressofusione di alluminio
 fonta aluminii
 valualumiini
 barwione aluminium

42 Anthrazit · anthracite

Incl. 1 x SMD-LED, 8 W
 1.000 lm, 3.000 K

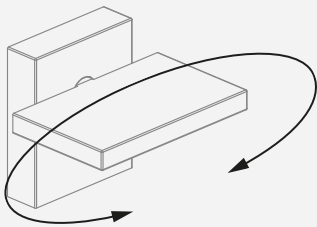
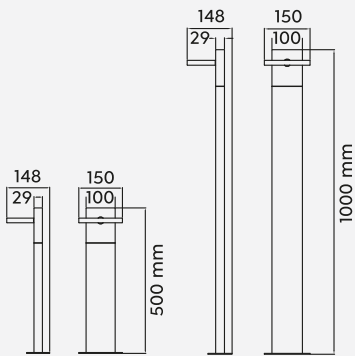
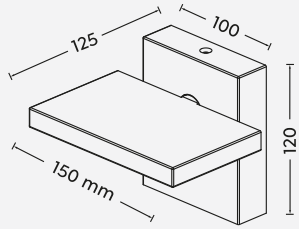

226360142



526360142

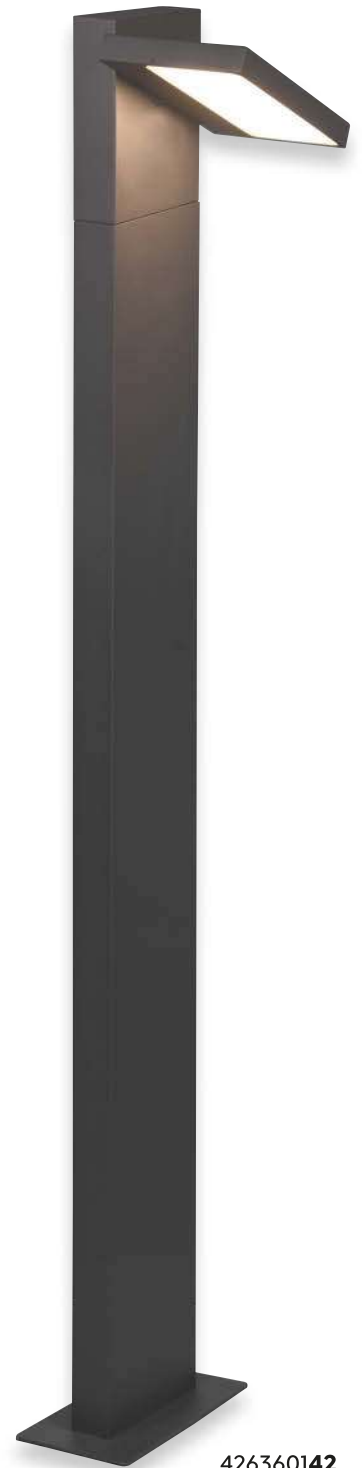

426360142





ROYA

Aluminium Druckguss
diecast aluminium
fonte d'aluminium
gegoten aluminium
aluminio fundido
pressofusione di alluminio
fonta aluminiu
valualumiini
barwione aluminium

42 Anthrazit · anthracite

Excl. 1 x GU10, max. 35 W

214260142
214269142
414260142
514260142



Excl. 2 x GU10, max. 35 W

214260242
214269242



214260142

214269242

214269142



514260142

414260142

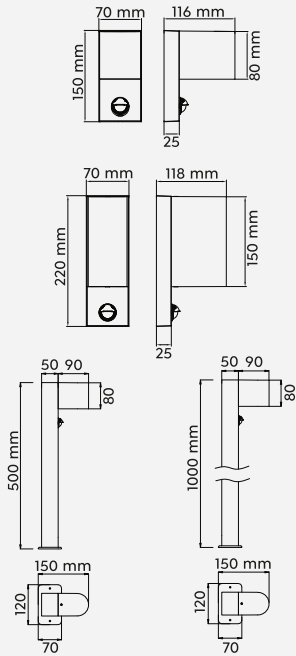

Empfohlen:
recommended:

LED GU10, 5 W
400 lm, 3.000 K
≈ 110°



955-50

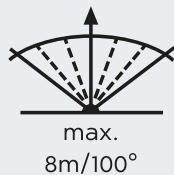

Bewegungssensor
Motion sensor
Détecteur de mouvement
Bewegingssensor
Sensor de movimiento
Sensore di movimento
Senzor de mişcare
Liiketunnistin
Czujnik ruchu



214260242

Aluminium Druckguss
 diecast aluminium
 fonte d'aluminium
 gegoten aluminium
 aluminio fundido
 pressofusione di alluminio
 fonta aluminiu
 valualumiini
 barwione aluminium

- 24** rostfarbig · rusty
- 31** Weiß matt · white mat
- 42** Anthrazit · anthracite

Excl. 2 x GU10, max. 35 W

- 204260224**
- 204269224**
- 204260231**
- 204269231**
- 204260242**
- 204269242**



Excl. 1 x GU10, max. 35 W

- 404260142**
- 504260142**

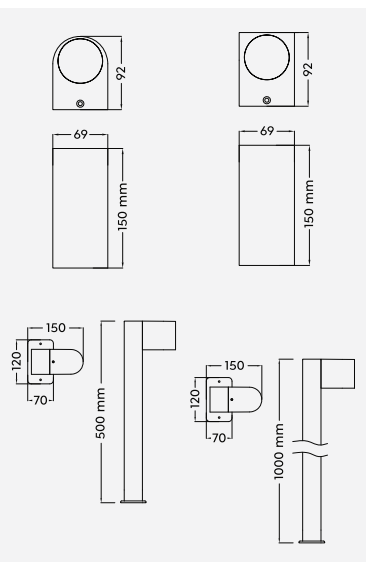

204260242



204269242



504260142



404260142

Empfohlen:
 recommended:

LED GU10, 5 W
 400 lm, 3.000 K
 > 110°



955-50



204260224



204260231



204269224



204269231

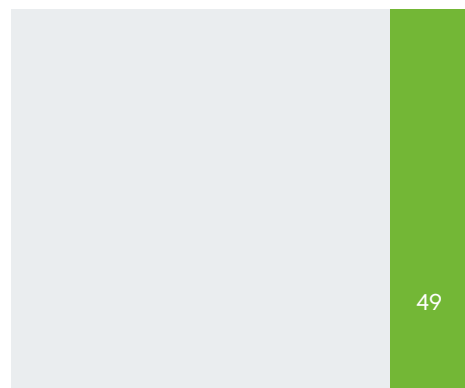

KAVERI

Aluminium Druckguss
 diecast aluminium
 fonte d'aluminium
 gegoten aluminium
 aluminio fundido
 pressofusione di alluminio
 fonta aluminiu
 valualumiini
 barwione aluminium

42 Anthrazit · anthracite

Excl. 1 x GU10, max. 28 W

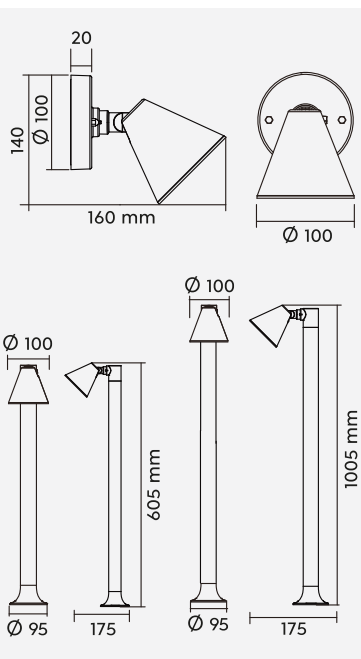

206060142

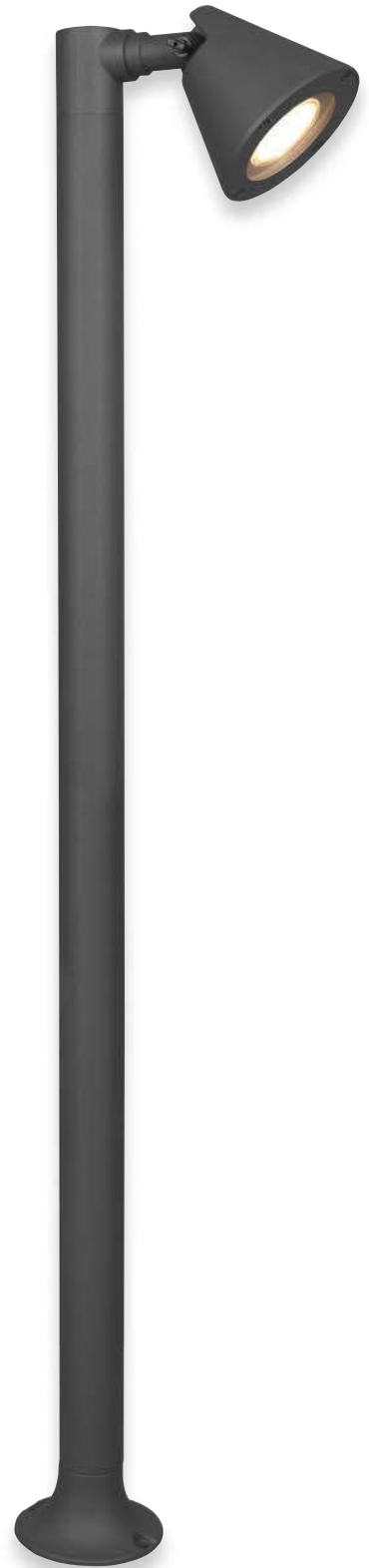

406060142

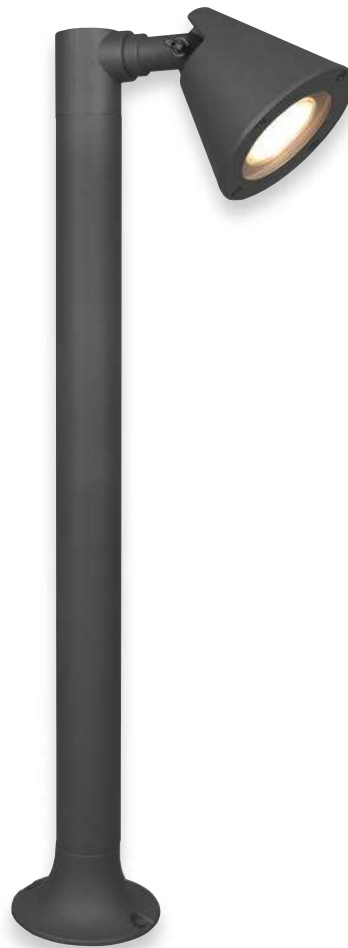

506060142

Empfohlen:
 recommended:

LED GU10, 5 W
 400 lm, 3.000 K
 > 110°



955-50





BELLY

Aluminium Druckguss
diecast aluminium
fonte d'aluminium
gegoten aluminium
aluminio fundido
pressofusione di alluminio
fonta aluminu
valualumiini
barwione aluminium

42 Anthrazit · anthracite

Incl. 1 x SMD-LED, 8,5 W
850 lm, 3.000 K

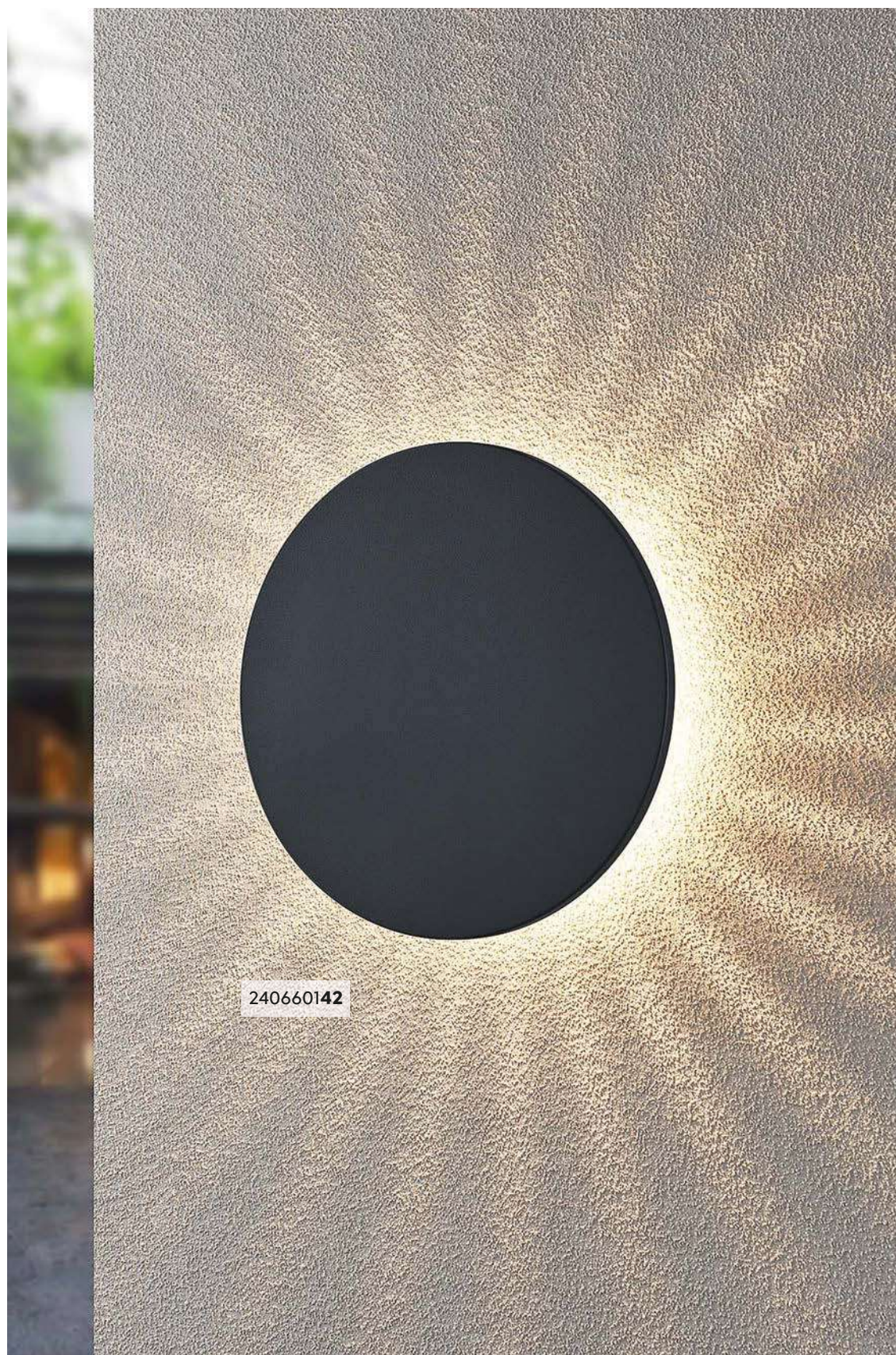
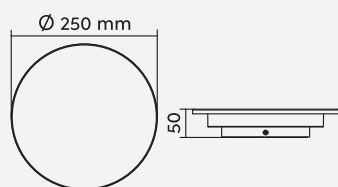

240660142





Aluminium Druckguss
 diecast aluminium
 fonte d'aluminium
 gegoten aluminium
 aluminio fundido
 pressofusione di alluminio
 fonta aluminiu
 valualumiini
 barwione aluminium

42 Anthrazit · anthracite

Incl. 1 x SMD-LED, 7,5 W
 800 lm, 3.000 K

221460142

Incl. 2 x SMD-LED, 9 W
 2 x 900 lm, 3.000 K

221460242

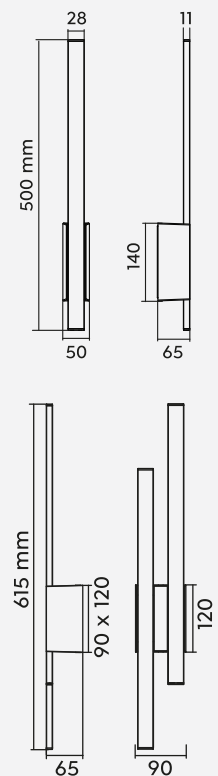

COLORADO

Aluminium Druckguss
diecast aluminium
fonte d'aluminium
gegoten aluminium
aluminio fundido
pressofusione di alluminio
fonta aluminiu
valualumiini
barwione aluminium

42 Anthrazit · anthracite

Incl. 2 x SMD-LED, 3 W
2 x 300 lm, 3.000 K

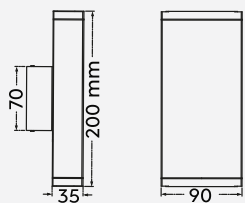

228460242

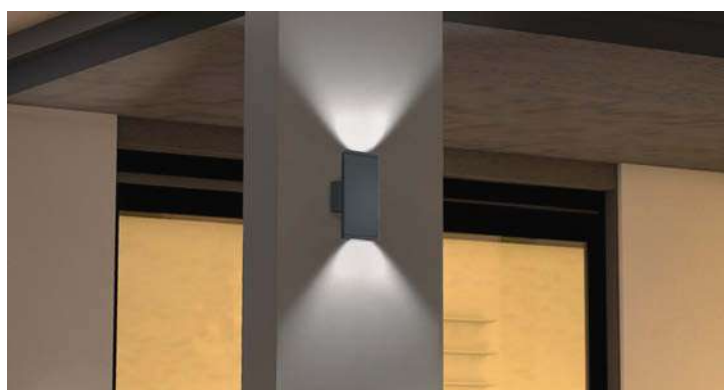

THAMES

Aluminium Druckguss
diecast aluminium
fonte d'aluminium
gegoten aluminium
aluminio fundido
pressofusione di alluminio
fonta aluminiu
valualumiini
barwione aluminium

42 Anthrazit · anthracite

87 titanfarbig · titan

Incl. 2 x SMD-LED, 3 W
2 x 340 lm, 3.000 K

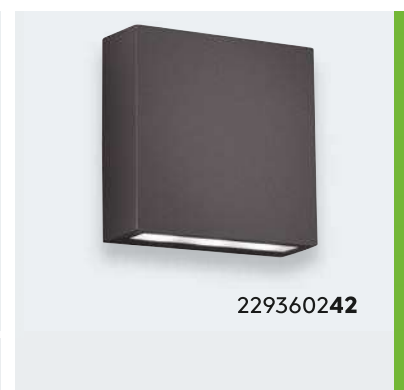
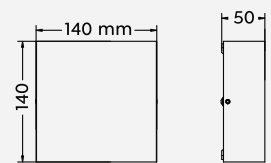

THAMES II

Aluminium Druckguss
diecast aluminium
fonte d'aluminium
gegoten aluminium
aluminio fundido
pressofusione di alluminio
fonta aluminii
valualumiini
barwione aluminium

31 Weiß matt · white mat

42 Anthrazit · anthracite

Incl. 2 x SMD-LED, 2,5 W
2 x 260 lm, 3.000 K

227560231

227560242

Incl. 2 x SMD-LED, 4,5 W
2 x 400 lm, 3.000 K

227660231

227660242

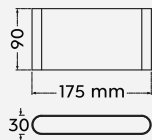
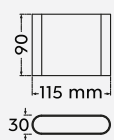

227560231



227560242



227660231



227660242

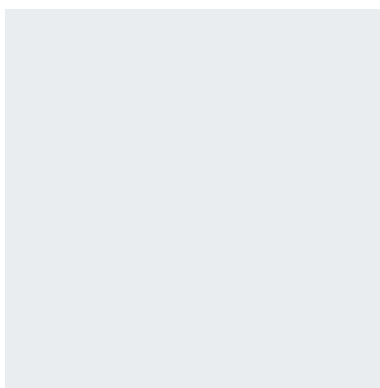

THAMES II

Aluminium Druckguss
diecast aluminium
fonte d'aluminium
gegoten aluminium
aluminio fundido
pressofusione di alluminio
fonta aluminiu
valualumiini
barwione aluminium

31 Weiß matt · white mat

42 Anthrazit · anthracite

Incl. 2 x SMD-LED, 8 W
2 x 800 lm, 3.000 K

226460231

226460242



226460231

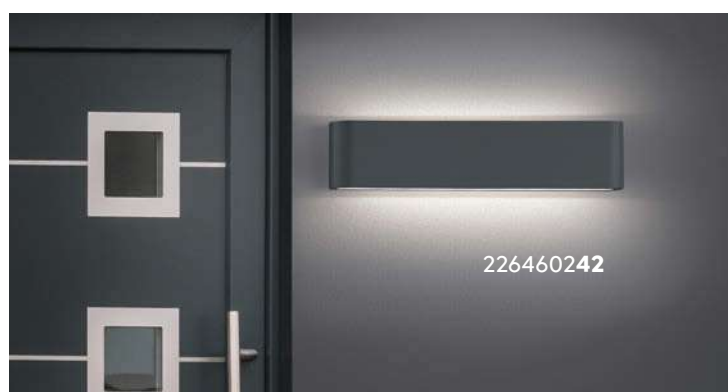
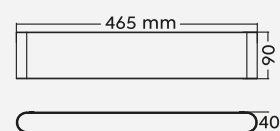

226460242

TRENT

Aluminium Druckguss
diecast aluminium
fonte d'aluminium
gegoten aluminium
aluminio fundido
pressofusione di alluminio
fonta aluminiu
valualumiini
barwione aluminium

31 Weiß matt · white mat

42 Anthrazit · anthracite

Incl. SMD-LED, 9 W
1.100 lm, 3.000 K

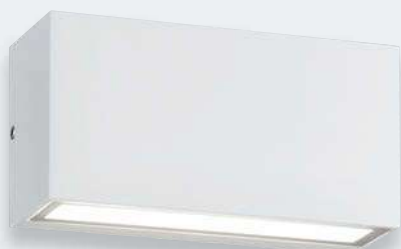
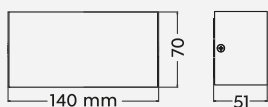

226960231



226960242

Aluminium Druckguss
 diecast aluminium
 fonte d'aluminium
 gegoten aluminium
 aluminio fundido
 pressofusione di alluminio
 fonta aluminiu
 valualumiini
 barwione aluminium

42 Anthrazit · anthracite

Incl. 2 x SMD-LED, 4,5 W
 2 x 580 lm, 3.000 K

IP65



226560242

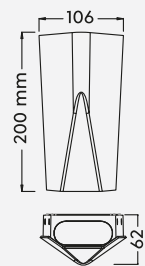

ADAJA

Aluminium Druckguss
diecast aluminium
fonte d'aluminium
gegoten aluminium
aluminio fundido
pressofusione di alluminio
fonta aluminii
valualumiini
barwione aluminium

31 Weiß matt · white mat
42 Anthrazit · anthracite

Incl. 2 x SMD-LED, 3 W
2 x 350 lm, 3.000 K

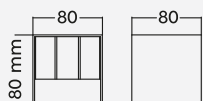

226860231



226860242

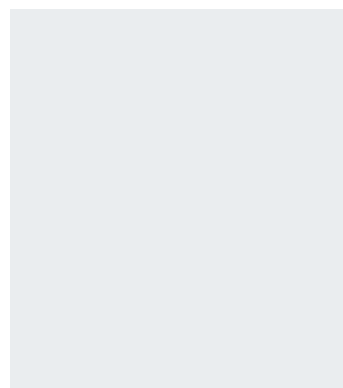
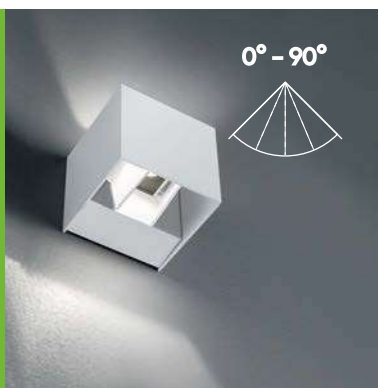

Aluminium Druckguss, Glas
 diecast aluminium, glass
 fonte d'aluminium, verre
 gegoten aluminium, glas
 aluminio fundido, vidrio
 pressofusione di alluminio, vetro
 fonta aluminiu, sticla
 valualumiini, lasi
 barwione aluminium, szkło

24 rostfarbig · rusty

31 Weiß matt · white mat

32 Schwarz matt · black mat

Excl. 2 x GU10, max. 40 W

212560224

212560231

212560232

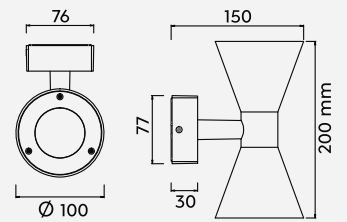

212560232



212560224



212560231

Empfohlen:
 recommended:

LED GU10, 5 W
 400 lm, 3.000 K
 ≥ 110°



955-50

SACRAMENTO

Aluminium Druckguss
diecast aluminium
fonte d'aluminium
gegoten aluminium
aluminio fundido
pressofusione di alluminio
fonta aluminiu
valualumiini
barwione aluminium

42 Anthrazit · anthracite

Incl. 1 x SMD-LED, 2 W
200 lm, 3.000 K

Incl. 1 x SMD-LED, 5,5 W
650 lm, 3.000 K

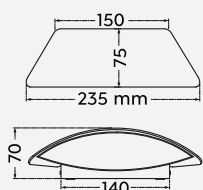

227860242

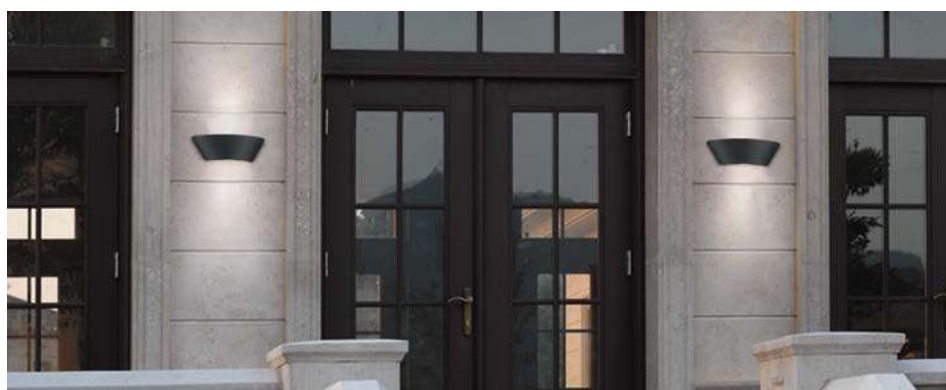

KONDA



228560242

Aluminium Druckguss, Kunststoff
diecast aluminium, plastic
fonte d'aluminium, plastique
gegoten aluminium, kunststof
aluminio fundido, plástico
pressofusione di alluminio, plastica
fonta aluminiu, plastic
valualumiini, muovi
barwione aluminium, plastik

42 Anthrazit · anthracite

Incl. 1 x SMD-LED, 9 W
1.200 lm, 3.000 K

IP65

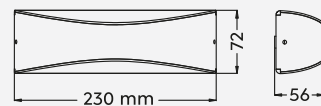

TRAVE

Aluminium Druckguss, Kunststoff
diecast aluminium, plastic
fonte d'aluminium, plastique
gegoten aluminium, kunststof
aluminio fundido, plástico
pressofusione di alluminio, plastica
fonta aluminiu, plastic
valualumiini, muovi
barwione aluminium, plastik

42 Anthrazit · anthracite

Incl. 1 x SMD-LED, 6 W
700 lm, 3.000 K

228760142

Incl. 1 x SMD-LED, 16 W
2.000 lm, 3.000 K

620160142

IP54

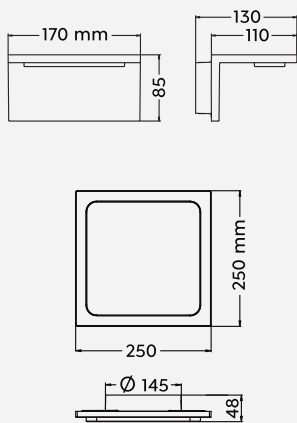

228760142



620160142



OHIO

Aluminium Druckguss, Kunststoff
diecast aluminium, plastic
fonte d'aluminium, plastique
gegoten aluminium, kunststof
aluminio fundido, plástico
pressofusione di alluminio, plastica
fonta aluminiu, plastic
valualumiini, muovi
barwione aluminium, plastik

42 Anthrazit · anthracite

87 titanfarbig · titan

Incl. 1 x SMD-LED, 7,5 W
800 lm, 3.000 K



220969142

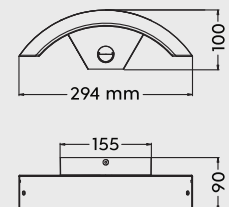

Bewegungssensor
Motion sensor
Détecteur de mouvement
Bewegingssensor
Sensor de movimiento
Sensore di movimento
Senzor de mişcare
Liiketunnistin
Czujnik ruchu

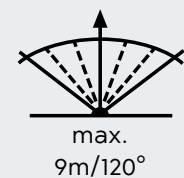

WITHAM

Aluminium Druckguss
 diecast aluminium
 fonte d'aluminium
 gegoten aluminium
 aluminio fundido
 pressofusione di alluminio
 fonta aluminiu
 valualumiini
 barwione aluminium

42 Anthrazit · anthracite

Incl. 1 x SMD-LED, 14 W
 1.550 lm, 2.300 + 3.000 + 4.000 K
277860142

Incl. 1 x SMD-LED, 10,5 W
 1.100 lm, 2.300 + 3.000 + 4.000 K
677860142

Incl. 1 x SMD-LED, 14,5 W
 1.450 lm, 2.300 + 3.000 + 4.000 K
477860142
577860142



677860142



277860142



477860142



577860142

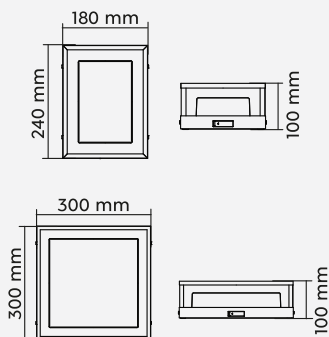

2.300 K



3.000 K



4.000 K

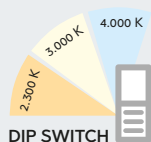

DIP SWITCH

Lichtfarben direkt an der Leuchte einstellbar

Colours directly adjustable at the lamp

Les couleurs de la lumière peuvent être réglées directement sur le luminaire

Lichtkleuren direct instelbaar op de lamp

Tonalidades de luz ajustables directamente en la lámpara

Colori della luce regolabili direttamente sulla lampada

Culori ale luminii reglabile direct de la bec

Valon väri asetettävissa suoraan valaisimesta

Barwy światła można ustawić bezpośrednio na oprawie

CUANDO

Aluminium Druckguss, Acryl
diecast aluminium, acryl
fonte d'aluminium, acryl
gegoten aluminium, acryl
aluminio fundido, acrílico
pressofusione di alluminio, acrilico
fonta aluminiu, acrilic
valualumiini, akryyli
barwione aluminium, akryl

42 Anthrazit · anthracite

Incl. SMD-LED, 11 W
1.400 lm, 3.000 K

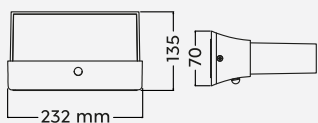
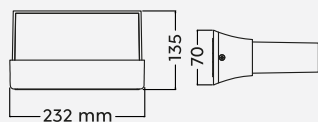

226660242



226669242

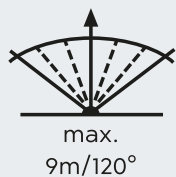

Bewegungssensor
Motion sensor
Détecteur de mouvement
Bewegingssensor
Sensor de movimiento
Sensore di movimento
Senzor de mişcare
Liiketunnistin
Czujnik ruchu

INDUS

Aluminium Druckguss, Kunststoff
diecast aluminium, plastic
fonte d'aluminium, plastique
gegoten aluminium, kunststof
aluminio fundido, plástico
pressofusione di alluminio, plastica
fonta aluminiu, plastic
valualumiini, muovi
barwione aluminium, plastik

42 Anthrazit · anthracite

Incl. 2 x SMD-LED, 4 W
2 x 500 lm, 3.000 K

IP54

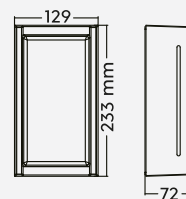

227360142



YANGTZE

Aluminium Druckguss, Kunststoff
diecast aluminium, plastic
fonte d'aluminium, plastique
gegoten aluminium, kunststof
aluminio fundido, plástico
pressofusione di alluminio, plastica
fonta aluminiu, plastic
valualumiini, muovi
barwione aluminium, plastik

01 Weiß · white

42 Anthrazit · anthracite

Incl. 1 x SMD-LED, 4,5 W
400 lm, 3.000 K

IP54

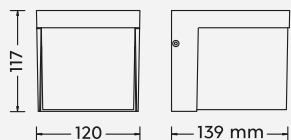

228260101



228260142

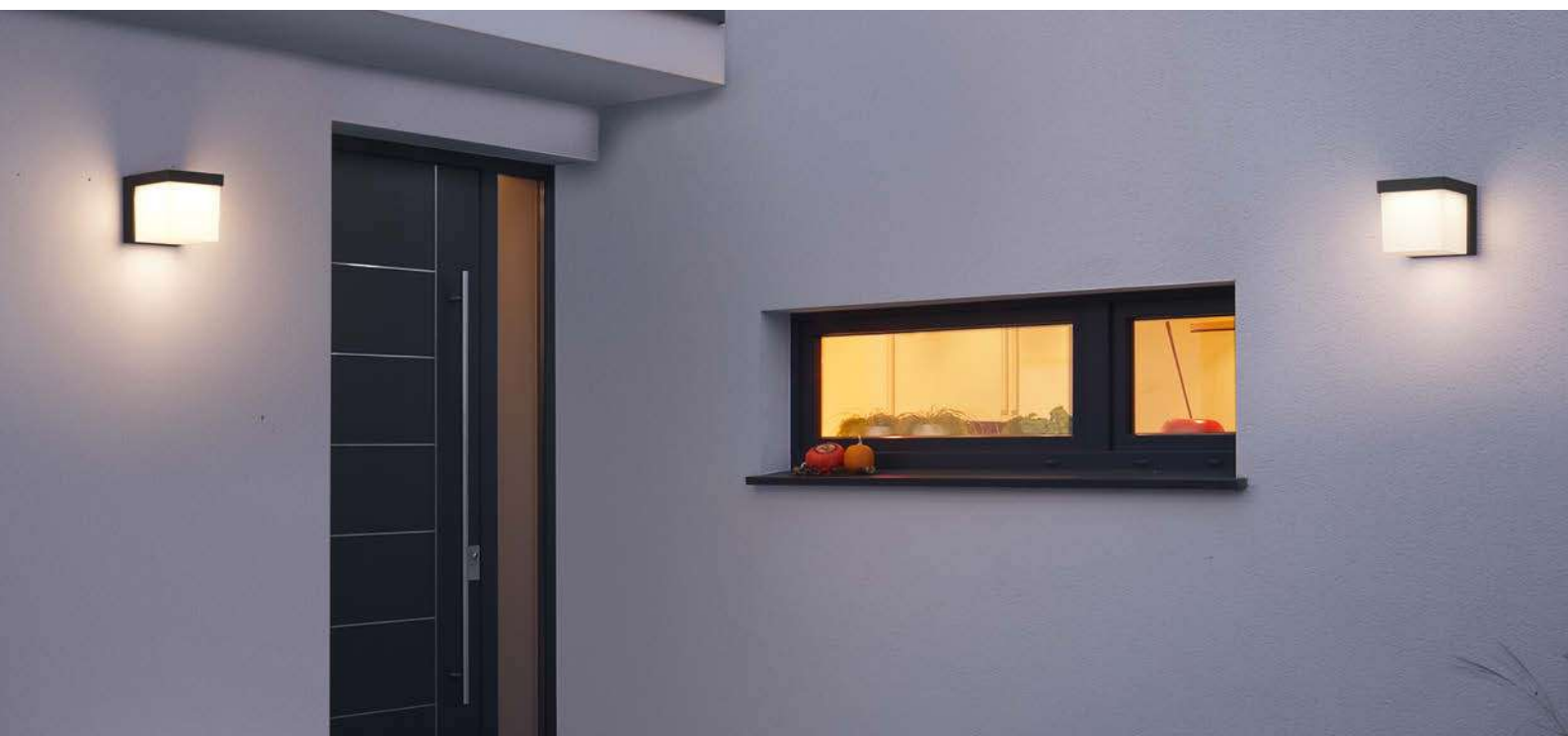

MITCHELL

Aluminium Druckguss, Acryl
diecast aluminium, acryl
fonte d'aluminium, acryl
gegoten aluminium, acryl
aluminio fundido, acrílico
pressofusione di alluminio, acrilico
fonta aluminiu, acrilic
valualumiini, akryyli
barwione aluminium, akryl

42 Anthrazit · anthracite

Incl. 1 x SMD-LED, 7,5 W
750 lm, 3.000 K
273360142

IP54

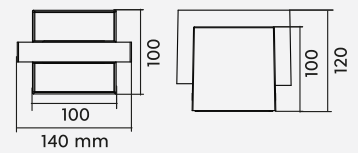

273360142



TIBER

Aluminium Druckguss
diecast aluminium
fonte d'aluminium
gegoten aluminium
aluminio fundido
pressofusione di alluminio
fonta aluminiu
valualumiini
barwione aluminium

42 Anthrazit · anthracite

Incl. 1 x COB-LED, 3 W
300 lm, 3.000 K

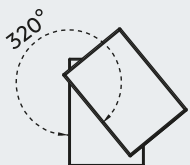
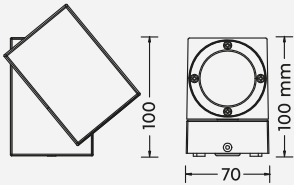

CLYDE



Aluminium Druckguss
diecast aluminium
fonte d'aluminium
gegoten aluminium
aluminio fundido
pressofusione di alluminio
fonta aluminiu
valualumiini
barwione aluminium

42 Anthrazit · anthracite

Incl. 2 x SMD-LED, 3 W
2 x 300 lm, 3.000 K

IP54

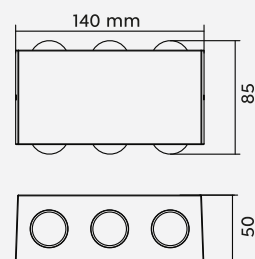

240760142

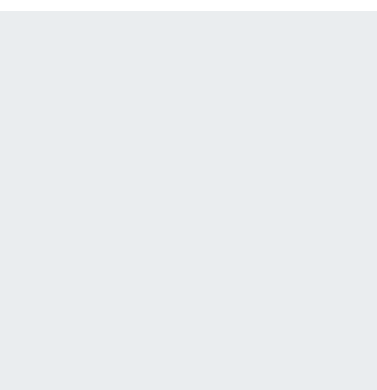

TUNGA

Aluminium Druckguss
diecast aluminium
fonte d'aluminium
gegoten aluminium
aluminio fundido
pressofusione di alluminio
fonta aluminiu
valualumiini
barwione aluminium

31 Weiß matt · white mat
42 Anthrazit · anthracite

Incl. 1 x SMD-LED, 3,5 W
420 lm, 3.000 K

222969131
222969142



Incl. 2 x SMD-LED, 3,5 W
2 x 420 lm, 3.000 K

222969231
222969242



222969131



222969142



222969231

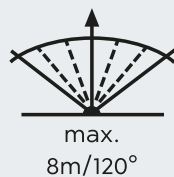
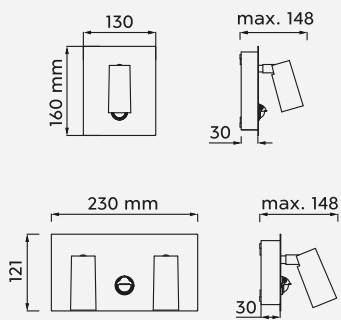

Bewegungssensor
Motion sensor
Détecteur de mouvement
Bewegingssensor
Sensor de movimiento
Sensore di movimento
Senzor de mişcare
Liiketunnistin
Czujnik ruchu

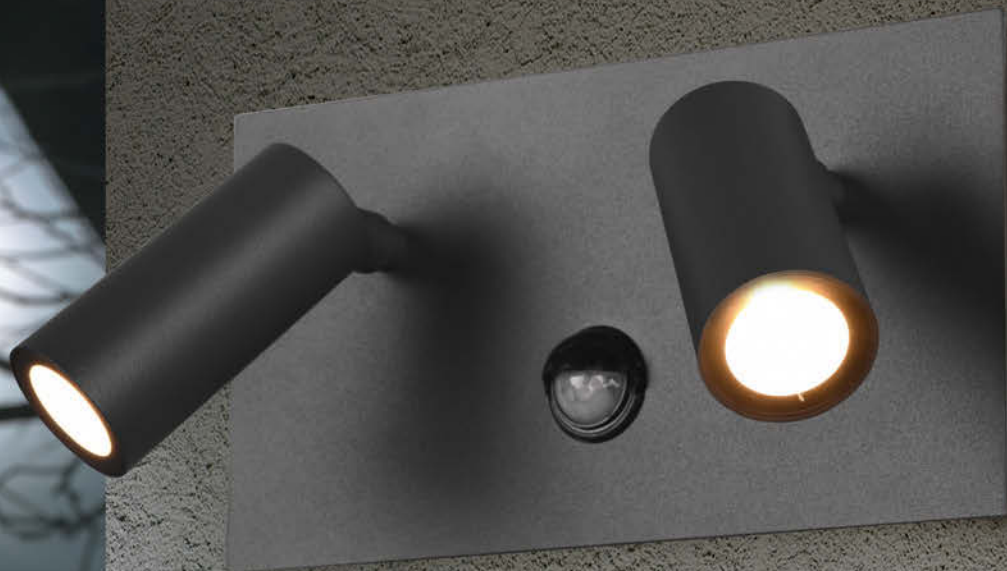

222969242

TUNGA

Aluminium Druckguss
diecast aluminium
fonte d'aluminium
gegoten aluminium
aluminio fundido
pressofusione di alluminio
fonta aluminii
valualumiini
barwione aluminium

31 Weiß matt · white mat
42 Anthrazit · anthracite

Incl. 1 x SMD-LED, 3,5 W
420 lm, 3.000 K

222960131
222960142

IP54

Incl. 2 x SMD-LED, 3,5 W
2 x 420 lm, 3.000 K

222960231
222960242

IP54



222960131



222960142

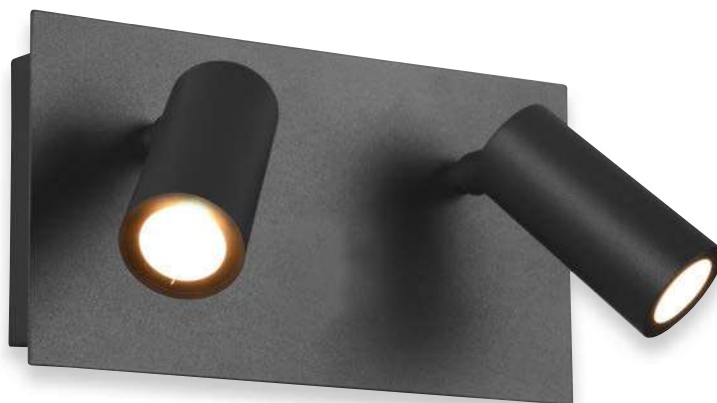

222960242

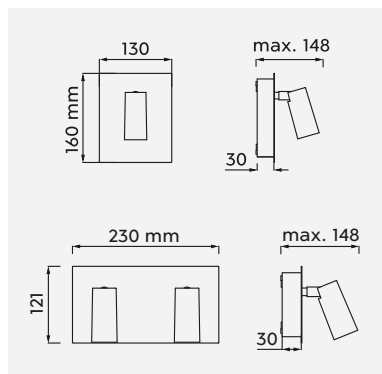



222960231

MUGA

Aluminium Druckguss, Kunststoff
diecast aluminium, plastic
fonte d'aluminium, plastique
gegoten aluminium, kunststof
aluminio fundido, plástico
pressofusione di alluminio, plastica
fonta aluminiu, plastic
valualumiini, muovi
barwione aluminium, plastik

42 Anthrazit · anthracite

Incl. 1 x SMD-LED, 5 W
550 lm, 3.000 K

IP54

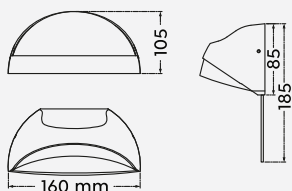

228360142



MERSEY

Aluminium Druckguss, Kunststoff
diecast aluminium, plastic
fonte d'aluminium, plastique
gegoten aluminium, kunststof
aluminio fundido, plástico
pressofusione di alluminio, plastica
fonta aluminiu, plastic
valualumiini, muovi
barwione aluminium, plastik

42 Anthrazit · anthracite

Excl. 2 x E14, max. 40 W

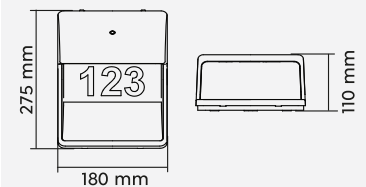

212160242



Dämmerungssensor
Dusk sensor
Décteur de crépuscule
Schemeringsensor
Sensor de oscuridad
Sensore crepuscolare
Sensor de lumina/amurg
Hämärätunnistin
Czujnik zmierzchowy



Empfohlen:
recommended:

LED E14, 3,5 W
320 lm, 3.000 K



983-40

PECOS

Aluminium Druckguss, Kunststoff
diecast aluminium, plastic
fonte d'aluminium, plastique
gegoten aluminium, kunststof
aluminio fundido, plástico
pressofusione di alluminio, plastica
fonta aluminiu, plastic
valualumiini, muovi
barwione aluminium, plastik

42 Anthrazit · anthracite

Incl. 1 x SMD-LED, 6 W
600 lm, 3.000 K

IP54

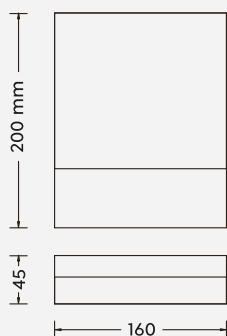

227760142



KASAI

Aluminium Druckguss, Kunststoff
diecast aluminium, plastic
fonte d'aluminium, plastique
gegooten aluminium, kunststof
aluminio fundido, plástico
pressofusione di alluminio, plastica
fonta aluminiu, plastic
valualumiini, muovi
barwione aluminium, plastik

42 Anthrazit · anthracite

Incl. 1 x SMD-LED, 9 W
850 lm, 3.000 K

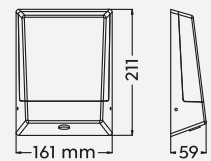

228669142



Dämmerungssensor
Dusk sensor
Décteur de crépuscule
Schemeringsensor
Sensor de oscuridad
Sensore crepuscolare
Sensor de lumina/amurg
Hämärätunnistin
Czujnik zmierzchowy
Alacakaranlık Algılayıcısı



TIMOK

Aluminium Druckguss, Kunststoff
diecast aluminium, plastic
fonte d'aluminium, plastique
gegoten aluminium, kunststof
aluminio fundido, plástico
pressofusione di alluminio, plastica
fonta aluminiu, plastic
valualumiini, muovu
barwione aluminium, plastik

01 Weiß · white

42 Anthrazit · anthracite

Incl. 1 x LED E27, 4,9 W
470 lm, 3.000 K

IP54

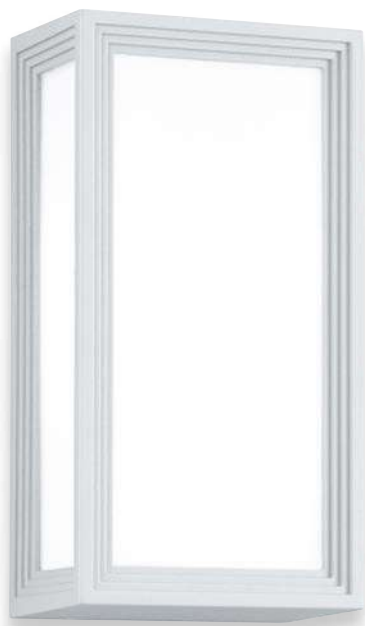
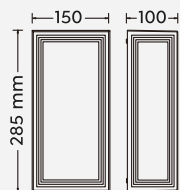

228060101



228060142



HONDO

Aluminium Druckguss, Kunststoff
diecast aluminium, plastic
fonte d'aluminium, plastique
gegoten aluminium, kunststof
aluminio fundido, plástico
pressofusione di alluminio, plastica
fonta aluminiu, plastic
valualumiini, muovi
barwione aluminium, plastik

42 Anthrazit · anthracite

Incl. 1 x SMD-LED, 3,5 W
330 lm, 3.000 K

IP54

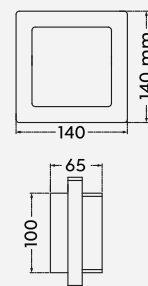

228960142



BREG

Aluminium Druckguss, Kunststoff
diecast aluminium, plastic
fonte d'aluminium, plastique
gegoten aluminium, kunststof
aluminio fundido, plástico
pressofusione di alluminio, plastica
fonta aluminiu, plastic
valualumiini, muovi
barwione aluminium, plastik

42 Anthrazit · anthracite

Incl. 1 x SMD-LED, 8,5 W
850 lm, 3.000 K

IP54

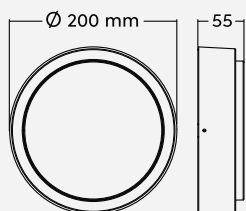

227260142

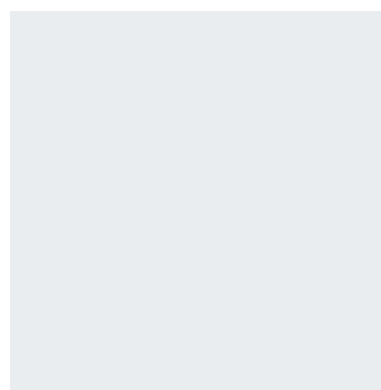

PEDRO

Aluminium Druckguss, Acryl
diecast aluminium, acryl
fonte d'aluminium, acryl
gegoten aluminium, acryl
aluminio fundido, acrílico
pressofusione di alluminio, acrilico
fonta aluminiu, acrilic
valualumiini, akryyli
barwione aluminium, akryl

42 Anthrazit · anthracite

Incl. 1 x SMD-LED, 9 W
1.000 lm, 3.000 K

IP54

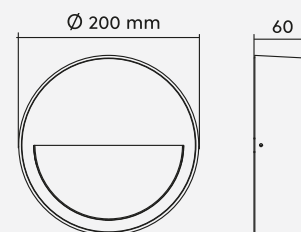

222860142



PIAVE

Kunststoff
plastic
plastique
kunststof
plástico
plastica
plastic
muovi
plastik

31 Weiß matt · white mat

42 Anthrazit · anthracite

Incl. SMD-LED, 11 W
1.180 lm, 3.000 K



676960131

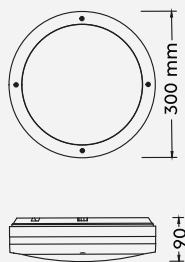

676960142

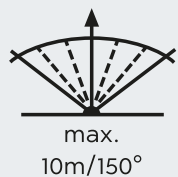

Bewegungssensor
Motion sensor
Détecteur de mouvement
Bewegingssensor
Sensor de movimiento
Sensore di movimento
Senzor de mișcare
Liiketunnistin
Czujnik ruchu





ARDILA

Aluminium Druckguss, Glas
diecast aluminium, glass
fonte d'aluminium, verre
gegoten aluminium, glas
aluminio fundido, vidrio
pressofusione di alluminio, vetro
fonta aluminiu, sticla
valualumiini, lasi
barwione aluminium, szkło

32 Schwarz matt · black mat

Excl. 1 x E27, max. 40 W

211660132

411660132

511660132



211660132

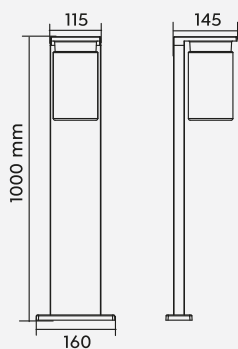
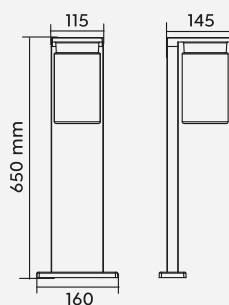
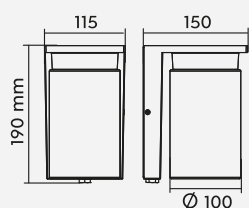

511660132



411660132

Empfohlen:
recommended:

Filament LED
E27, 4 W
470 lm, 2.700 K



Dämmerungssensor per Schalter deaktivierbar

On and off switchable dusk sensor

Décteur de crépuscule commutable

Aan en uit schakelbare schemeringsensor

Sensor de oscuridad conmutable on/off

Sensore crepuscolare commutabile on/off

senzor de lumina/amurg on/off

On/off kytkettävä hämärätunnistin

Czujnik zmierzchowy dezaktywowany przez przełącznika



HOOSIC

Aluminium Druckguss, Kunststoff
 diecast aluminium, plastic
 fonte d'aluminium, plastique
 gegoten aluminium, kunststof
 aluminio fundido, plástico
 pressofusione di alluminio, plastica
 fonta aluminiu, plastic
 valualumiini, muovi
 barwione aluminium, plastik

24 rostfarbig · rusty

Excl. 1 x E27, max. 28 W

222260124

422260124

522260124

Excl. 2 x E27, max. 28 W

222260224



IP44



222260124



222260224



522260124



422260124

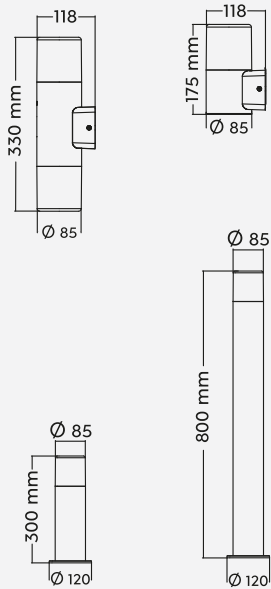

Empfohlen:
 recommended:

LED E27, 4,9 W
 470 lm, 3.000 K



987-60





HOOSIC

Aluminium Druckguss, Kunststoff
 diecast aluminium, plastic
 fonte d'aluminium, plastique
 gegoten aluminium, kunststof
 aluminio fundido, plástico
 pressofusione di alluminio, plastica
 fonta aluminiu, plastic
 valualumiini, muovi
 barwione aluminium, plastik

42 Anthrazit · anthracite

Excl. 1 x E27, max. 28 W

222260142

422260142

522260142

Excl. 2 x E27, max. 28 W

222260242



222260142



222260242



522260142



422260142

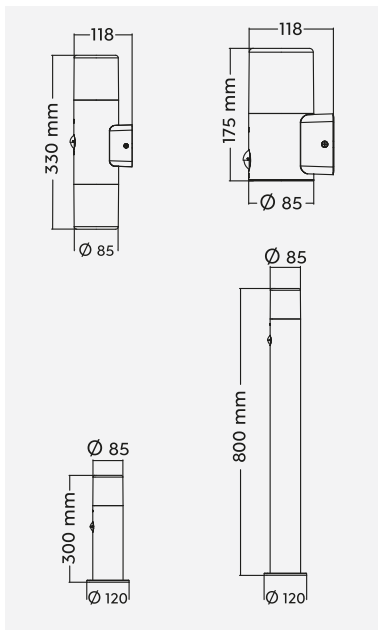

Empfohlen:
 recommended:

LED E27, 4,9 W
 470 lm, 3.000 K



987-60



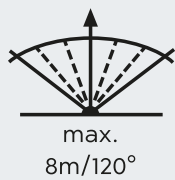

Bewegungssensor
Motion sensor
Détecteur de mouvement
Bewegungssensor
Sensor de movimiento
Sensore di movimento
Senzor de mișcare
Liiketunnistin
Czujnik ruchu



HOOSIC

Aluminium Druckguss, Kunststoff
 diecast aluminium, plastic
 fonte d'aluminium, plastique
 gegoten aluminium, kunststof
 aluminio fundido, plástico
 pressofusione di alluminio, plastica
 fonta aluminiu, plastic
 valualumiini, muovi
 barwione aluminium, plastik

42 Anthrazit · anthracite

Excl. 1 x E27, max. 28 W

224060142

424060142

524060142

Excl. 2 x E27, max. 28 W

224060242



IP44



224060142



224060242



424060142



524060142

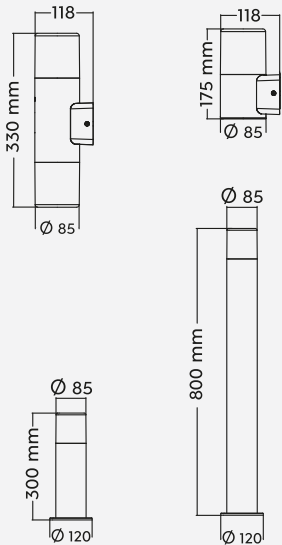

Empfohlen:
 recommended:

LED E27, 4,9 W
 470 lm, 3.000 K



987-60

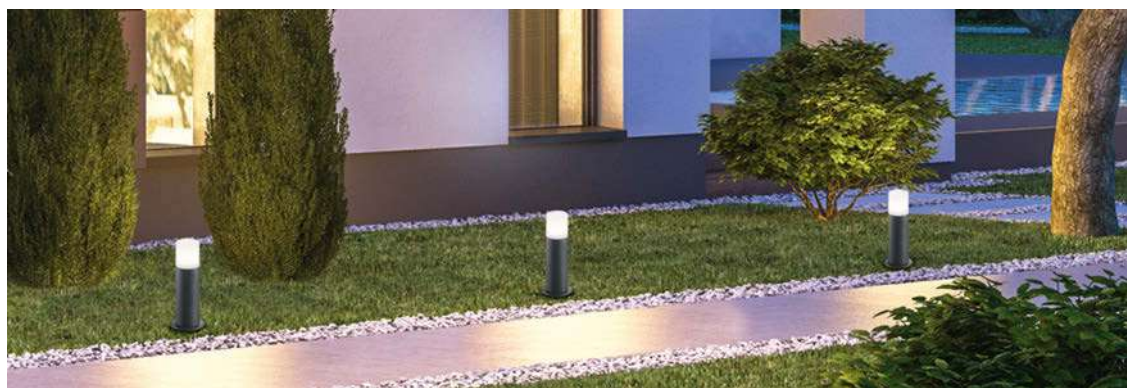

HOOSIC

Aluminium Druckguss, Kunststoff
diecast aluminium, plastic
fonte d'aluminium, plastique
gegoten aluminium, kunststof
aluminio fundido, plástico
pressofusione di alluminio, plastica
fonta aluminiu, plastic
valualumiini, muovi
barwione aluminium, plastik

42 Anthrazit · anthracite

Excl. 1 x E27, max. 28 W



IP44



424067142



HUDSON

Aluminium Druckguss, Kunststoff
 diecast aluminium, plastic
 fonte d'aluminium, plastique
 gegoten aluminium, kunststof
 aluminio fundido, plástico
 pressofusione di alluminio, plastica
 fonta aluminiu, plastic
 valualumiini, muov
 barwione aluminium, plastik

42 Anthrazit · anthracite

Incl. 1 x LED E14, 4 W
 320 lm, 3.000 K

220060142

420060142

520060142

Incl. 2 x LED E14, 4 W
 2 x 320 lm, 3.000 K

220060242

IP44



220060142



220060242



420060142



520060142

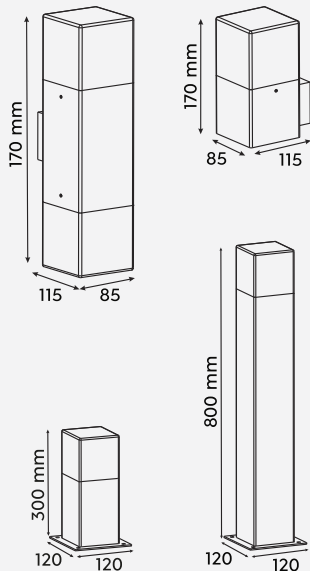

Incl. LED E14, 3,5 W
 320 lm, 3.000 K



983-40





CUBANGO

Aluminium Druckguss, Kunststoff
diecast aluminium, plastic
fonte d'aluminium, plastique
gegoten aluminium, kunststof
aluminio fundido, plástico
pressofusione di alluminio, plastica
fonta aluminiu, plastic
valualumiini, muov
barwione aluminium, plastik

42 Anthrazit · anthracite

Incl. 1 x LED E27, 5 W
400 lm, 3.000 K

IP54

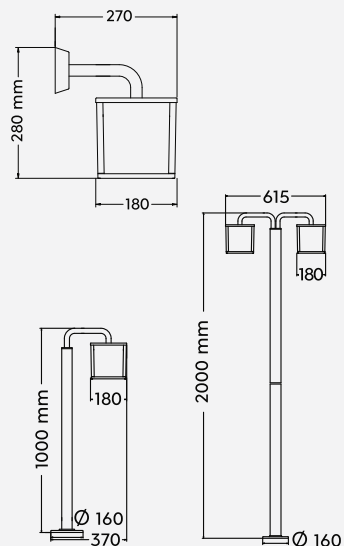

221560142



421560142



421560242

Incl. LED E27, 4,9 W
470 lm, 3.000 K





NORMAN

Aluminium Druckguss, Acryl
diecast aluminium, acryl
fonte d'aluminium, acryl
gegoten aluminium, acryl
aluminio fundido, acrílico
pressofusione di alluminio, acrilico
fonta aluminiu, acrilic
valualumiini, akryyli
barwione aluminium, akryl

24 rostfarbig · rusty
31 Weiß matt · white mat
42 Anthrazit · anthracite

Excl. 1 x E27, max. 40 W

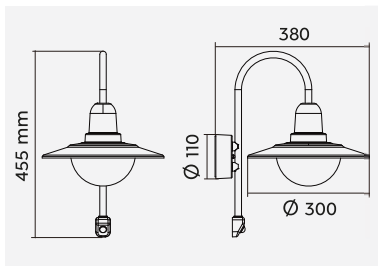

207269131



207269142

Empfohlen:
recommended:

LED E27, 4,9 W
470 lm, 3.000 K

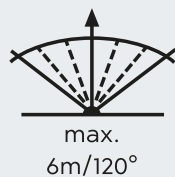

Bewegungssensor
Motion sensor
Détecteur de mouvement
Bewegungssensor
Sensor de movimiento
Sensore di movimento
Senzor de mişcare
Liiketunnistin
Czujnik ruchu



207269124

COOPER

Edelstahl, Kunststoff
steel, plastic
acier, plastique
staal, kunststof
acero, plástico
acciaio, plastica
inox, plastic
teräs, muovi
stal, plastik

42 Anthrazit · anthracite

Excl. 1 x E27, max. 40 W



IP44

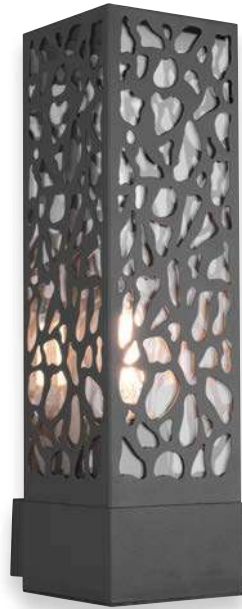

207360142



407360142



507360142

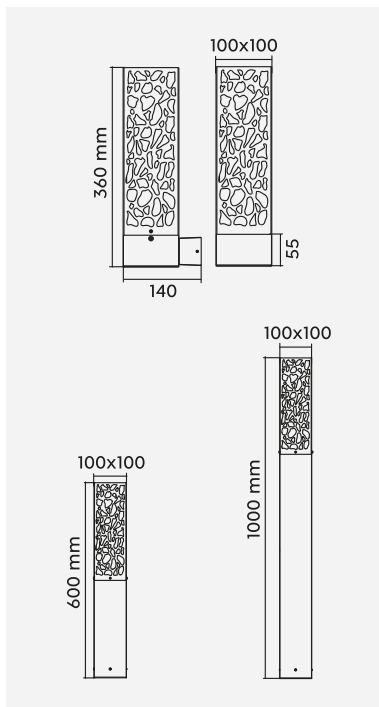

Empfohlen:
recommended:

Filament LED
E27, 4 W
470 lm, 2.700 K



987-400





CANNING

Aluminium Druckguss, Naturholz
 diecast aluminium, natural wood
 fonte d'aluminium, bois naturel
 gegoten aluminium, natuur hout
 aluminio fundido, madera natural
 pressofusione di alluminio, legno naturale
 fonta aluminu, lemn natural
 valualumiini, luonnonpuu
 barwione aluminium, drewno naturalne

30 holzfarbig / Anthrazit ·
 wood coloured / anthracite

Excl. 1 x GU10, max. 28 W



IP44

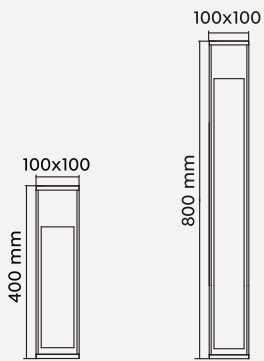
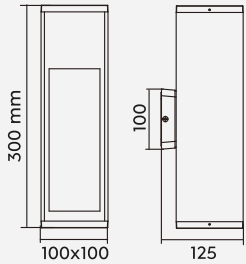

209660130



509660130



409660130

Empfohlen:
 recommended:

LED GU10, 5 W
 400 lm, 3.000 K
 > 110°



955-50





GARONNE

Aluminium Druckguss,
Naturholz, Glas
diecast aluminium,
natural wood, glass
fonte d'aluminium,
bois naturel, verre
gegoten aluminium,
natuur hout, glas
aluminio fundido,
madera natural, vidrio
pressofusione di alluminio,
legno naturale, vetro
fonta aluminiu,
lemn natural, sticla
valualumiini,
luonnonpuu, lasi
barwione aluminium,
drewno naturalne, szkło

30 holzfarbig / Anthrazit ·
wood coloured / anthracite

Excl. 1 x E27, max. 40 W

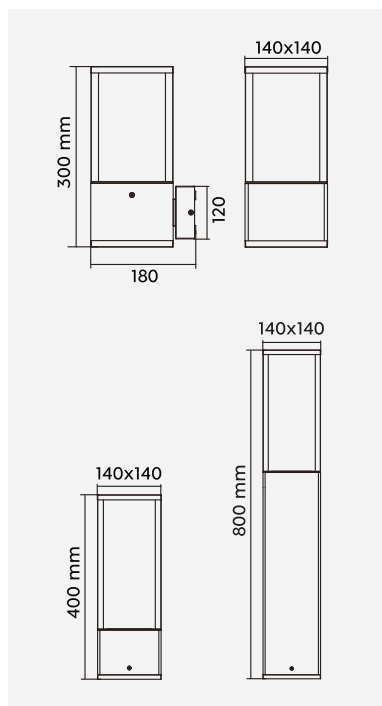

201860130



501860130



401860130

Empfohlen:
recommended:

Filament LED
E27, 4 W
470 lm, 2.700 K



987-400





GARONNE

Aluminium Druckguss, Glas
 diecast aluminium, glass
 fonte d'aluminium, verre
 gegoten aluminium, glas
 aluminio fundido, vidrio
 pressofusione di alluminio, vetro
 fonta aluminiu, sticla
 valualumiini, lasi
 barwione aluminium, szkło

42 Anthrazit · anthracite

Excl. 1 x E27, max. 40 W

201860142

401860142

501860142

Excl. 2 x E27, max. 40 W

201860242

601860242

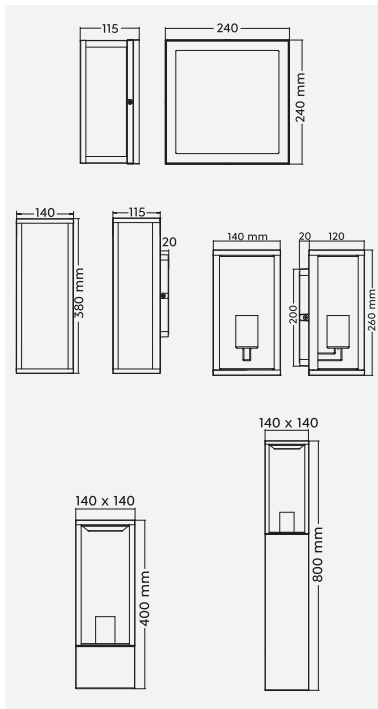

601860242



201860142



201860242



401860142



501860142

Empfohlen:
 recommended:

Filament LED
 E27, 7 W
 806 lm, 3.000 K



987-600

Empfohlen:
 recommended:

Filament LED
 E27, 4 W
 470 lm, 2.700 K



987-400





LUNGA

Aluminium Druckguss, Glas
diecast aluminium, glass
fonte d'aluminium, verre
gegoten aluminium, glas
aluminio fundido, vidrio
pressofusione di alluminio, vetro
fonta aluminiu, sticla
valualumiini, lasi
barwione aluminium, szkło

42 Anthrazit · anthracite

Excl. 1 x E27, max. 40 W

212069142



Excl. 1 x E27, max. 40 W

212060142

412060142

512060142

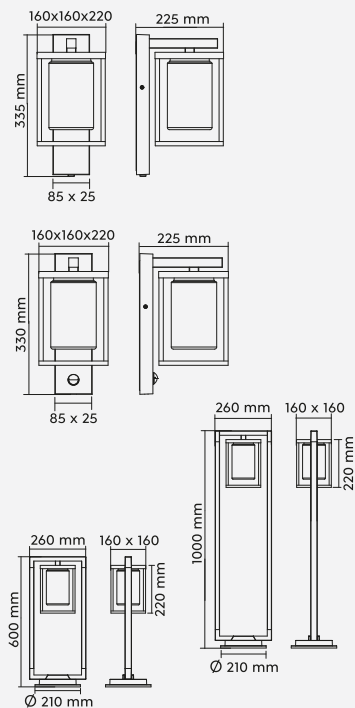

212060142



512060142

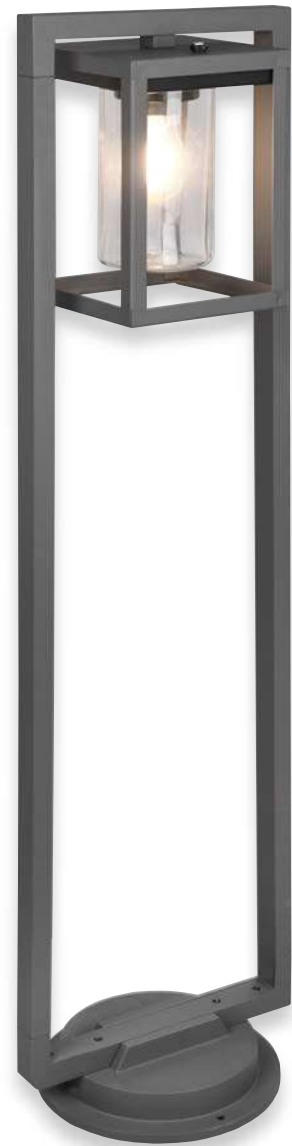

412060142

Empfohlen:
recommended:

Filament LED
E27, 4 W
470 lm, 2.700 K



987-400



Dämmerungssensor per Schalter deaktivierbar

On and off switchable dusk sensor

Décteur de crépuscule commutable

Aan en uit schakelbare schemeringsensor

Sensor de oscuridad conmutable on/off

Sensore crepuscolare commutabile on/off

senzor de lumina/amurg on/off

On/off kytkettävä hämärätunnistin

Czujnik zmierzchowy dezaktywowany przez przełącznika

Aç-kapa anahtarlı karanlık sensörü





212069142



Bewegungssensor
Motion sensor
Détecteur de mouvement
Bewegingssensor
Sensor de movimiento
Sensore di movimento
Senzor de mişcare
Liiketunnistin
Czujnik ruchu

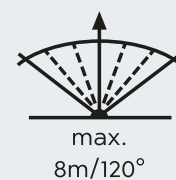

SAMBESI

Aluminium Druckguss, Acryl
diecast aluminium, acryl
fonte d'aluminium, acryl
gegoten aluminium, acryl
aluminio fundido, acrílico
pressofusione di alluminio, acrilico
fonta aluminiu, acrilic
valualumiini, akryyli
barwione aluminium, akryl

42 Anthrazit · anthracite

Excl. 1 x E27, max. 28 W

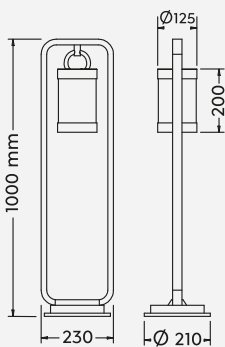
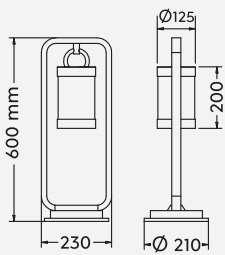
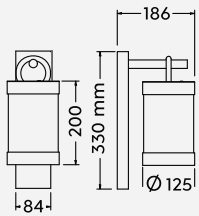

204160142



504160142

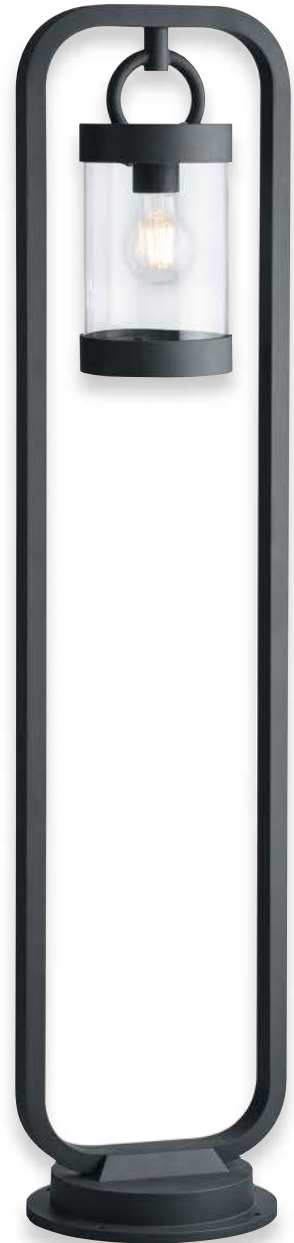

404160142

Empfohlen:
recommended:

Filament LED
E27, 4 W
470 lm, 2.700 K



987-400



Dämmerungssensor per Schalter deaktivierbar

On and off switchable dusk sensor

Détecteur de crépuscule commutable

Aan en uit schakelbare schemeringsensor

Sensor de oscuridad conmutable on/off

Sensore crepuscolare commutabile on/off

senzor de lumina/amurg on/off

On/off kytettävä hämärätunnistin

Czujnik zmierzchowy dezaktywowany przez przełącznika

Aç-kapa anahtarlı karanlık sensörü

SAMBESI

Aluminium Druckguss, Acryl
diecast aluminium, acryl
fonte d'aluminium, acryl
gegoten aluminium, acryl
aluminio fundido, acrílico
pressofusione di alluminio, acrilico
fonta aluminiu, acrilic
valualumiini, akryyli
barwione aluminium, akrýl

31 Weiß matt · white mat

Excl. 1 x E27, max. 28 W

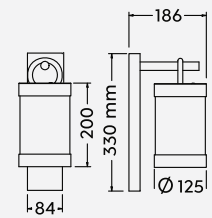

204160131

Empfohlen:
recommended:

Filament LED
E27, 4 W
470 lm, 2.700 K



987-400

SAMBESI

Aluminium Druckguss, Acryl
diecast aluminium, acryl
fonte d'aluminium, acryl
gegoten aluminium, acryl
aluminio fundido, acrílico
pressofusione di alluminio, acrilico
fonta aluminiu, acrilic
valualumiini, akryyli
barwione aluminium, akryl

24 rostfarbig · rusty

Excl. 1 x E27, max. 28 W



204160124

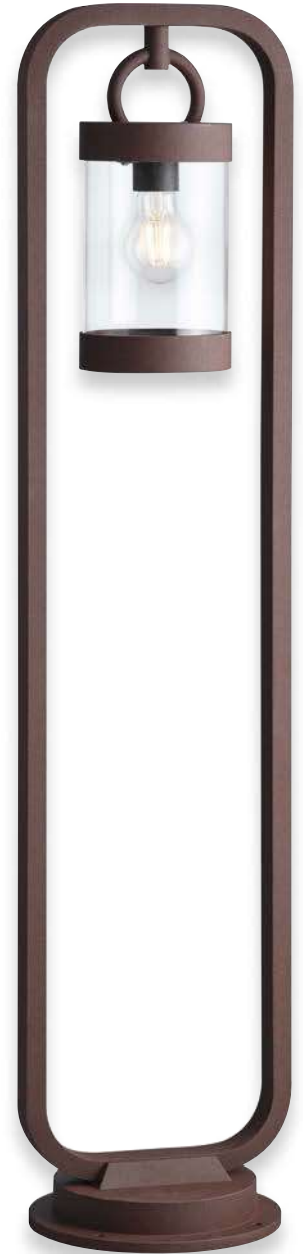

404160124



504160124

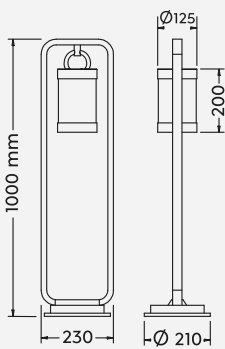
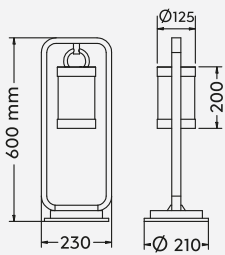
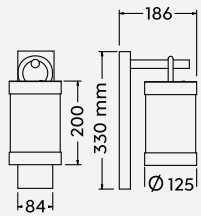

Empfohlen:
recommended:

Filament LED
E27, 4 W
470 lm, 2.700 K



987-400



Dämmerungssensor per Schalter deaktivierbar

On and off switchable dusk sensor

Décteur de crépuscule commutable

Aan en uit schakelbare schemeringsensor

Sensor de oscuridad conmutable on/off

Sensore crepuscolare commutabile on/off

senzor de lumina/amurg on/off

On/off kytkettävä hämärätunnistin

Czujnik zmierzchowy dezaktywowany przez przełącznika

Aç-kapa anahtarlı karanlık sensörü

SAMBESI

Aluminium Druckguss, Kunststoff
diecast aluminium, plastic
fonte d'aluminium, plastique
gegooten aluminium, kunststof
aluminio fundido, plástico
pressofusione di alluminio, plastica
fonta aluminiu, plastic
valualumiini, muovi
barwione aluminium, plastik

24 rostfarbig · rusty

31 Weiß matt · white mat

42 Anthrazit · anthracite

Excl. 1 x E27, max. 28 W

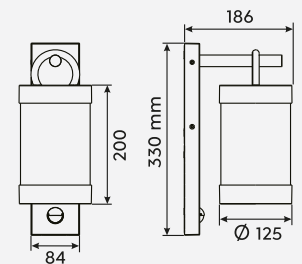

204169142



204169131



Bewegungssensor
Motion sensor
Détecteur de mouvement
Bewegingssensor
Sensor de movimiento
Sensore di movimento
Senzor de mişcare
Liiketunnistin
Czujnik ruchu

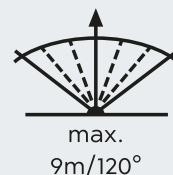

204169124

CAVADO

Aluminium Druckguss, Kunststoff
 diecast aluminium, plastic
 fonte d'aluminium, plastique
 gegoten aluminium, kunststof
 aluminio fundido, plástico
 pressofusione di alluminio, plastica
 fonta aluminiu, plastic
 valualumiini, muov
 barwione aluminium, plastik

31 Weiß matt · white mat
42 Anthrazit · anthracite

Excl. 1 x E27, max. 40 W
211069131
211069142



Excl. 1 x E27, max. 40 W
211060131
211060142
411060142

Excl. 3 x E27, max. 40 W
411060342

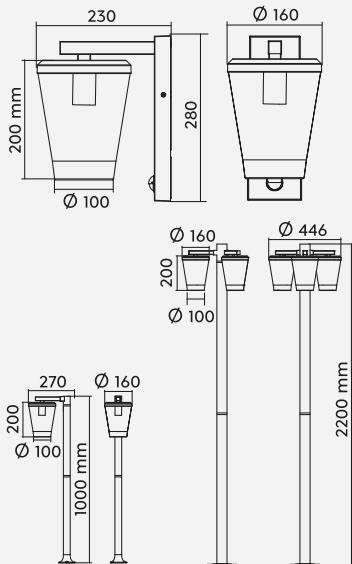

211069131



211060131



211069142



211060142



411060142

Empfohlen:
 recommended:

Filament LED
 E27, 4 W
 470 lm, 2.700 K



987-400

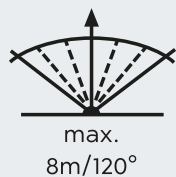



411060342

TANARO

Aluminium Druckguss, Acryl
 diecast aluminium, acryl
 fonte d'aluminium, acryl
 gegoten aluminium, acryl
 aluminio fundido, acrílico
 pressofusione di alluminio, acrilico
 fonta aluminiu, acrilic
 valualumiini, akryyli
 barwione aluminium, akryl

24 rostfarbig · rusty

42 Anthrazit · anthracite

Excl. 1 x E27, max. 40 W



IP44

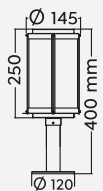
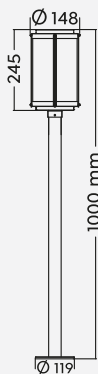
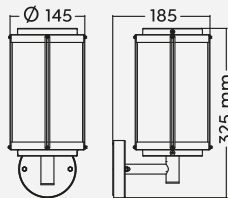

202360124



502360124



502360142



402360142



402360124

Empfohlen:
 recommended:

Filament LED
 E27, 4 W
 470 lm, 2.700 K





202360142

TUELA

Aluminium Druckguss, Glas
 diecast aluminium, glass
 fonte d'aluminium, verre
 gegoten aluminium, glas
 aluminio fundido, vidrio
 pressofusione di alluminio, vetro
 fonta aluminiu, sticla
 valualumiini, lasi
 barwione aluminium, szkło

24 rostfarbig · rusty
42 Anthrazit · anthracite

Excl. 1 x E27, max. 40 W

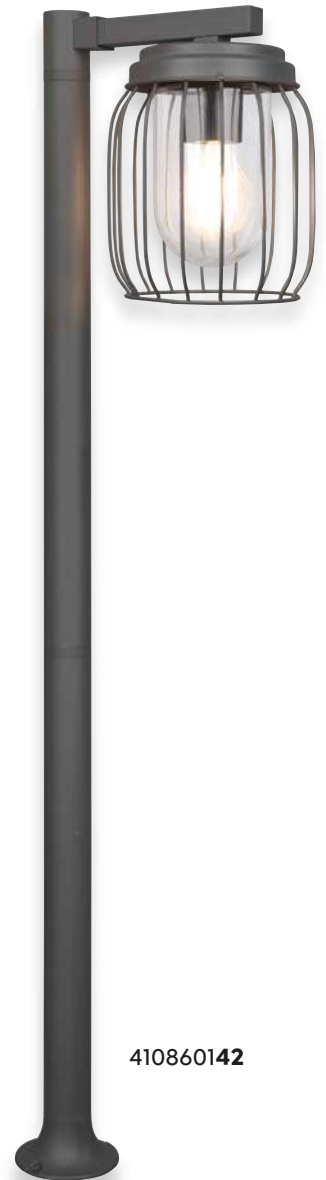
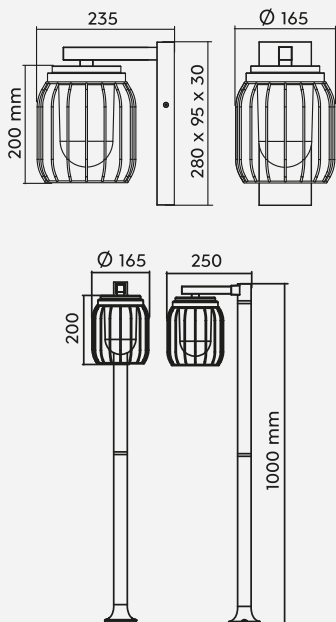

Empfohlen:
 recommended:

Filament LED
 E27, 4 W
 470 lm, 2.700 K



987-400



TUELA

Aluminium Druckguss, Glas
diecast aluminium, glass
fonte d'aluminium, verre
gegoten aluminium, glas
aluminio fundido, vidrio
pressofusione di alluminio, vetro
fonta aluminiu, sticla
valualumiini, lasi
barwione aluminium, szkło

24 rostfarbig · rusty

42 Anthrazit · anthracite

Excl. 1 x E27, max. 40 W



IP44

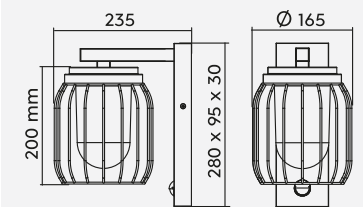

210869124



210869142



Bewegungssensor
Motion sensor
Détecteur de mouvement
Bewegungssensor
Sensor de movimiento
Sensore di movimento
Senzor de mişcare
Liiketunnistin
Czujnik ruchu

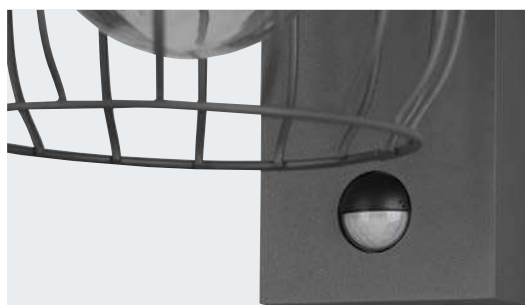

max.
8m/120°

BRENTA

Aluminium Druckguss, Glas
diecast aluminium, glass
fonte d'aluminium, verre
gegoten aluminium, glas
aluminio fundido, vidrio
pressofusione di alluminio, vetro
fonta aluminiu, sticla
valualumiini, lasi
barwione aluminium, szkło

24 rostfarbig · rusty

42 Anthrazit · anthracite

Excl. 1 x E27, max. 40 W



IP44

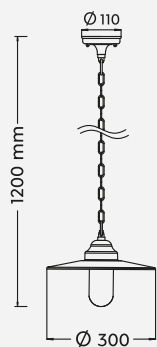

301760142



Empfohlen:
recommended:

Filament LED
E27, 4 W
470 lm, 2.700 K



987-400



BRENTA

Aluminium Druckguss, Glas
diecast aluminium, glass
fonte d'aluminium, verre
gegoten aluminium, glas
aluminio fundido, vidrio
pressofusione di alluminio, vetro
fonta aluminiu, sticla
valualumiini, lasi
barwione aluminium, szkło

24 rostfarbig · rusty

42 Anthrazit · anthracite

Excl. 1 x E27, max. 40 W



IP44

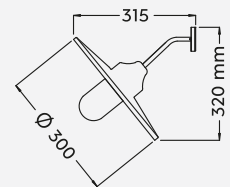

201760124



201760142



Empfohlen:
recommended:

Filament LED
E27, 4 W
470 lm, 2.700 K



987-400

OLONA

Aluminium Druckguss, Glas
diecast aluminium, glass
fonte d'aluminium, verre
gegoten aluminium, glas
aluminio fundido, vidrio
pressofusione di alluminio, vetro
fonta aluminiu, sticla
valualumiini, lasi
barwione aluminium, szkło

24 rostfarbig · rusty

42 Anthrazit · anthracite

Excl. 1 x E27, max. 20 W



IP23

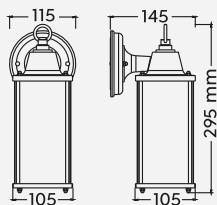

Empfohlen:
recommended:

Filament LED
E27, 4 W
470 lm, 2.700 K



987-400



DUERO

Aluminium Druckguss, Glas
diecast aluminium, glass
fonte d'aluminium, verre
gegoten aluminium, glas
aluminio fundido, vidrio
pressofusione di alluminio, vetro
fonta aluminiu, sticla
valualumiini, lasi
barwione aluminium, szkło

24 rostfarbig · rusty

42 Anthrazit · anthracite

Excl. 1 x E27, max. 40 W



IP44

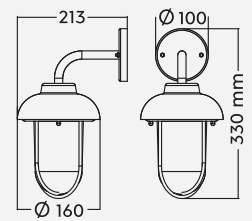

202760142



202760124



Empfohlen:
recommended:

Filament LED
E27, 4 W
470 lm, 2.700 K



987-400

Bodeneinbaustrahler
 Recessed floor lamps
 Luminaires encastrés de sol
 grond inbouwspot
 Lámparas de pie empotradas
 Incasso Calpestabili
 Lampi incastrate in podea
 upotetut maavalot
 wpuszczzone lampy podłogowe

07 Nickel matt · nickel mat

Incl. SMD-LED, 3,5 W
 350 lm, 3.000 K

IP65

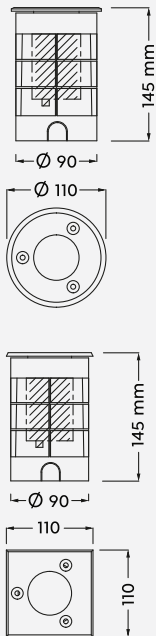

821660107



821669107



Abstrahlwinkel
 Emission angle
 Angle de rayonnement
 Uitstraalhoek
 Ángulo de emisión
 Angolo di emissione
 Unghiul de emisii
 Säteilukulma
 Kąt emisji



Belastbarkeit
 Resilience
 Limite de charge
 Belastbaarheid
 Resistencia
 Resistenza
 Rezistența la solicitare
 Kuormitettavuus
 Nośność



821660207

Bodeneinbaustrahler
 Recessed floor lamps
 Luminaires encastrés de sol
 grond inbouwspot
 Lámparas de pie empotradas
 Incasso Calpestabili
 Lampi incastrate in podea
 upotetut maavalot
 wpuszczane lampy podłogowe

07 Nickel matt · nickel mat

Incl. SMD-LED, 8 W
 900 lm, 3.000 K

IP65

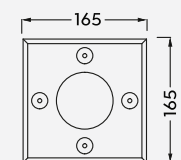
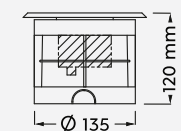
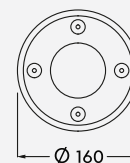
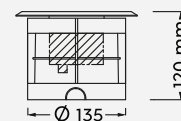

Abstrahlwinkel
 Emission angle
 Angle de rayonnement
 Uitstraalhoek
 Ángulo de emisión
 Angolo di emissione
 Unghiul de emisii
 Säteilykulma
 Kät emisiji



Belastbarkeit
 Resilience
 Limite de charge
 Belastbaarheid
 Resistencia
 Resistenza
 Rezistența la solicitare
 Kuormitettavuus
 Nośność



821669207

UBANGI

Aluminium Druckguss
diecast aluminium
fonte d'aluminium
gegoten aluminium
aluminio fundido
pressofusione di alluminio
fonta aluminii
valualumiini
barwione aluminium

42 Anthrazit · anthracite

Excl. 1 x GU10, max. 28 W

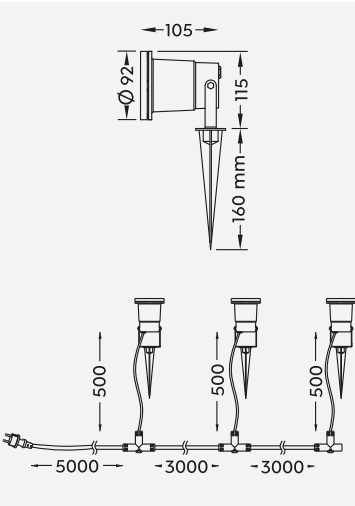

Empfohlen:
recommended:

LED GU10, 5 W
400 lm, 3.000 K
≥ 110°



955-50



800260342
3er Set / Set 3

MAREB

Aluminium Druckguss
diecast aluminium
fonte d'aluminium
gegoten aluminium
aluminio fundido
pressofusione di alluminio
fonta aluminiu
valualumiini
barwione aluminium

42 Anthrazit · anthracite

Incl. 1 x SMD-LED, 11 W
1.000 lm, 3.000 K

IP65

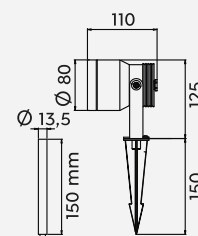

GARTENSTECKDOSEN · GARDEN SOCKETS

Polyresin
polyresin
polyresin
polyresin
poliresina
poliestere
polirasina
polyresiini
polyresin

11 Grau · grey

Zeitschaltuhr · timer
max. 3.600 W

9961-11



max. 3.600 W

9962-11

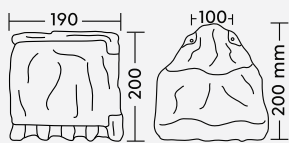

9961-11



9962-11





9964-42

Aluminium Druckguss
diecast aluminium
fonte d'aluminium
gegoten aluminium
aluminio fundido
pressofusione di alluminio
fonta alumiiniu
valualumiini
barwione aluminium

42 Anthrazit · anthracite

max. 3.600 W

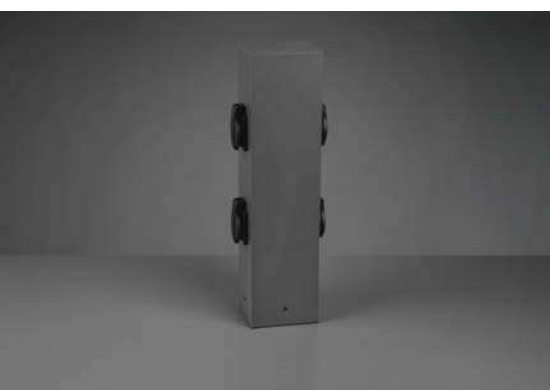
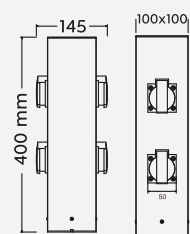

UNIVERSAL-ERDSPIESS · GROUND SPIKE

Erdspieß, Edelstahl
Ground spike, steel
Piquet de terre, acier
Aardingspin, staal
Espiga, acero
Picchetto, acciaio
Țepușă pentru pământ, inox
Maapiikki, teräs
Žerdź, stal

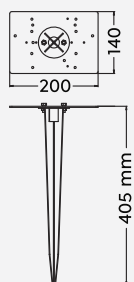

9960-07

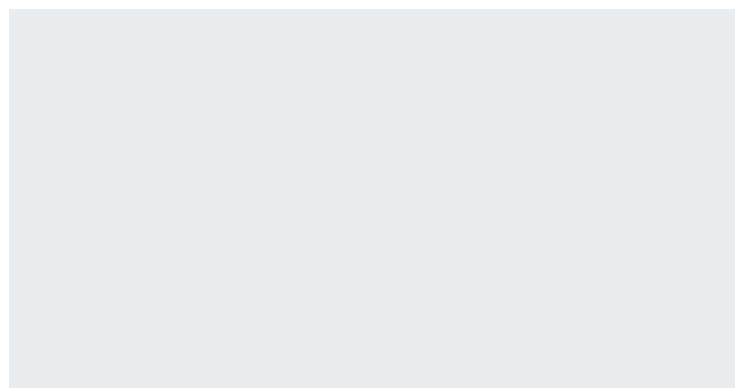

ECKBEFESTIGUNG · CORNER FASTENING

Eckbefestigung, Kunststoff
Corner fastening, plastic
Montage en angle, plastique
Hoekbevestiging, kunststof
Cantонера, plástico
Montaggio ad angolo, plastica
Fixare pentru colț, plastic
Kulmakiinnike, muovi
Okucie narożne, plastik

32 Schwarz matt · black mat



9965-32

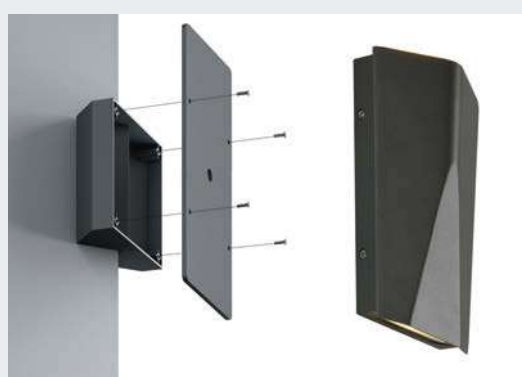
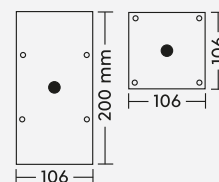

PUNO

Kunststoff
plastic
plastique
kunststof
plástico
plastica
plastic
muovi
plastik

32 Schwarz matt · black mat

Incl. SMD-LED, 8 W
800 lm, 3.000 K

IP54

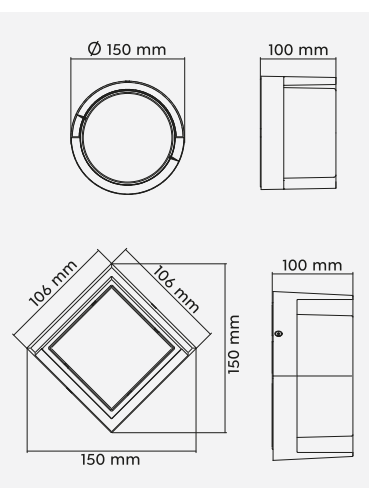



R20026942



Edelstahl
steel
acier
staal
acero
acciaio
inox
teräs
stal

42 Anthrazit · anthracite

Excl. 2 x GU10, max. 10 W

R20026242



Excl. 2 x GU10, max. 10 W

R20026942

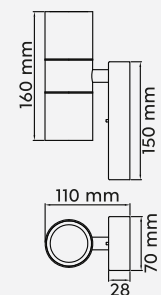
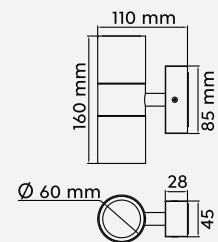

Dämmerungssensor
Dusk sensor
Détecteur de crépuscule
Schemeringsensor
Sensor de oscuridad
Sensore crepuscolare
Sensor de lumina/amurg
Hämärätunnistin
Czujnik zmierzchowy



R20026242

Empfohlen:
recommended:

LED GU10, 5 W
400 lm, 3.000 K
≈ 110°



955-50

CORDOBA

Kunststoff
plastic
plastique
kunststof
plástico
plastica
plastic
muovi
plastik

31 Weiß matt · white mat

32 Schwarz matt · black mat

Incl. 2 x SMD-LED, 2 W
2 x 200 lm, 3.000 K



R28222631

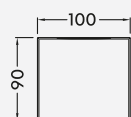
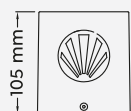

R28222632



ROSARIO

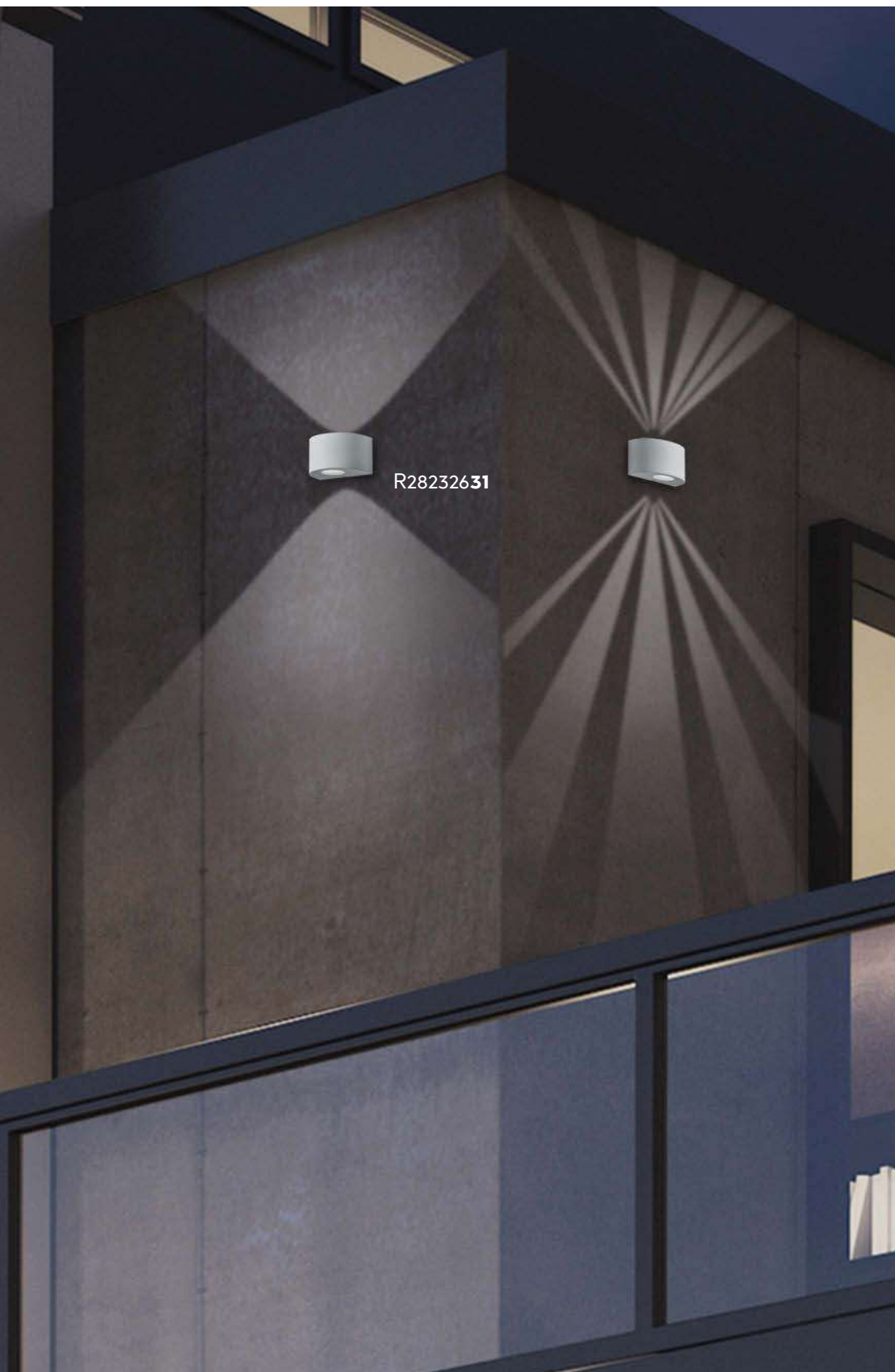

Kunststoff
plastic
plastique
kunststof
plástico
plastica
plastic
muovi
plastik

- 31** Weiß matt · white mat
- 32** Schwarz matt · black mat

Incl. 2 x SMD-LED, 2 W
2 x 200 lm, 3.000 K

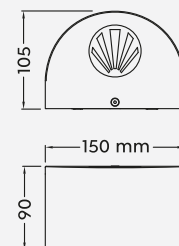

MOLINA

Aluminium Druckguss, Kunststoff
diecast aluminium, plastic
fonte d'aluminium, plastique
gegoten aluminium, kunststof
aluminio fundido, plástico
pressofusione di alluminio, plastica
fonta aluminiu, plastic
valualumiini, muovi
barwione aluminium, plastik

42 Anthrazit · anthracite

Incl. 2 x SMD-LED, 4,6 W
2 x 550 lm, 3.000 K

IP54

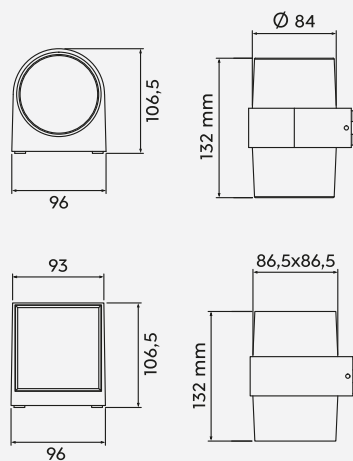

R22052142



R22062142



LIMEIRA

Kunststoff
plastic
plastique
kunststof
plástico
plastica
plastic
muovi
plastik

32 Schwarz matt · black mat

Incl. 2 x SMD-LED, 3,5 W
2 x 380 lm, 3.000 K

IP44

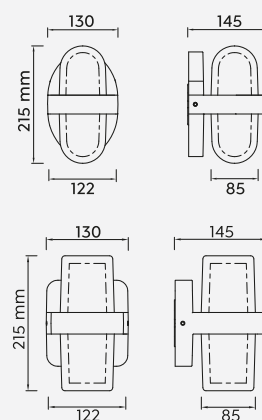

R24256232



R24266232



VENADO

Kunststoff
plastic
plastique
kunststof
plástico
plastica
plastic
muovi
plastik

42 Anthrazit · anthracite

Incl. 1 x SMD-LED, 9,5 W
1.000 lm, 3.000 K

IP54

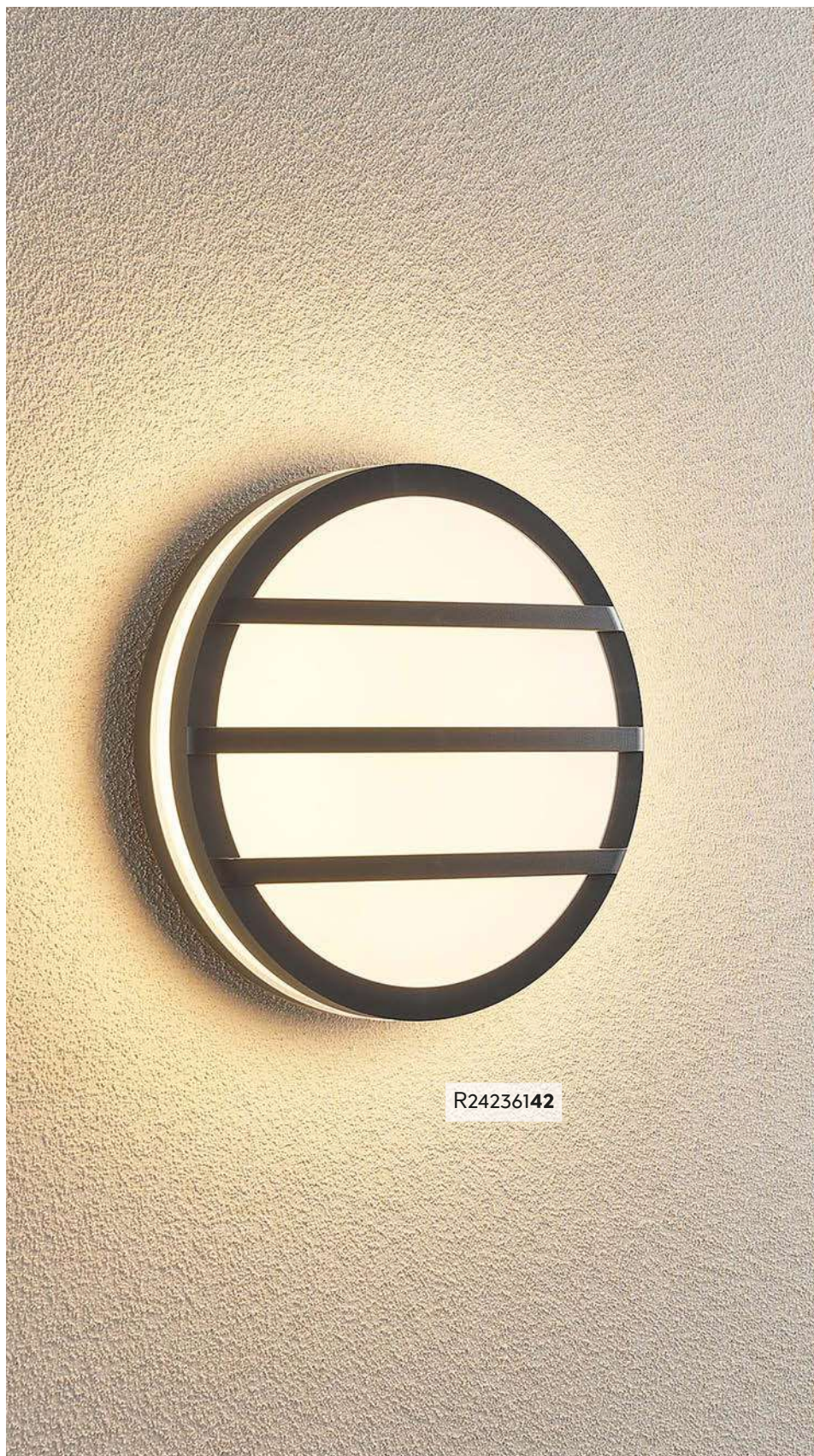
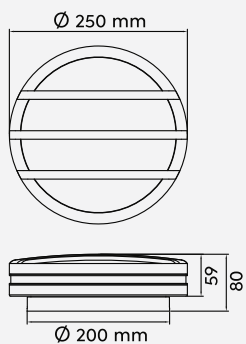

R24236142



MORENA

Kunststoff
plastic
plastique
kunststof
plástico
plastica
plastic
muovi
plastik

32 Schwarz matt · black mat

Incl. 1 x SMD-LED, 14 W
1.500 lm, 2.300 + 3.000 + 4.000 K

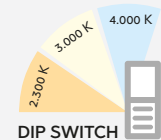
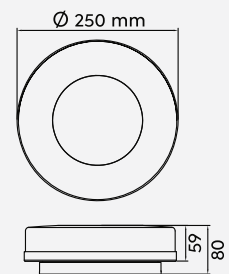

R24246132



DIP SWITCH

Lichtfarben direkt an der Leuchte einstellbar

Colours directly adjustable at the lamp

Les couleurs de la lumière peuvent être réglées directement sur le luminaire

Lichtkleuren direct instelbaar op de lamp

Tonalidades de luz ajustables directamente en la lámpara

Colori della luce regolabili direttamente sulla lampada

Culori ale luminii reglabile direct de la bec

Valon väri asetettävissa suoraan valaisimesta

Barwy światła można ustawić bezpośrednio na oprawie



2.300 K



3.000 K



4.000 K

KENDAL

Kunststoff
 plastic
 plastique
 kunststof
 plástico
 plastica
 plastic
 muovi
 plastik

31 Weiß matt · white mat

42 Anthrazit · anthracite

Incl. SMD-LED, 11 W
 1.180 lm, 3.000 K

R62151131

R62151142

IP54

Incl. SMD-LED, 12 W
 1.400 lm, 3.000 K

R22151131

R22151142

IP54



R62151131



R62151142



R22151131



R22151142

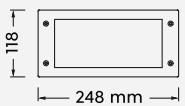
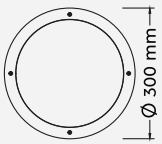



CAMARO

Kunststoff
 plastic
 plastique
 kunststof
 plástico
 plastica
 plastic
 muovi
 plastik

31 Weiß matt · white mat
42 Anthrazit · anthracite

Excl. 1 x E27, max. 12 W

R60501031
R60501042

Excl. 2 x E27, max. 12 W

R60502031
R60502042

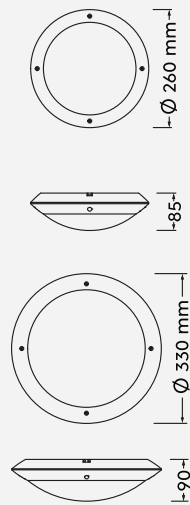

R60501031



R60501042



R60502031



R60502042

Empfohlen:
 recommended:

LED E27, 4 W
 320 lm, 3.000 K



986-60



PUELO

Aluminium Druckguss, Kunststoff
diecast aluminium, plastic
fonte d'aluminium, plastique
gegoten aluminium, kunststof
aluminio fundido, plástico
pressofusione di alluminio, plastica
fonta aluminiu, plastic
valualumiini, muovi
barwione aluminium, plastik

31 Weiß matt · white mat

32 Schwarz matt · black mat

Excl. 1 x E27, max. 10 W



IP44

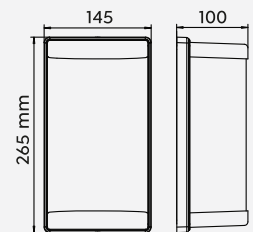

R21186132



R21186131

Empfohlen:
recommended:

LED E27, 4,9 W
470 lm, 3.000 K



987-60



Außenbeleuchtung ist viel mehr als nur funktional!

Dank integriertem Akku sind die transportablen Leuchten flexibel und setzen spannende Akzente im Garten, auf dem Balkon oder der Terrasse - ganz ohne Kabel! Für die richtige Stimmung sorgen zusätzliche Highlights wie RGB-Farbwechsler oder Bluetooth-Funktion für kabelloses Musik hören. Die perfekte Beleuchtung für gemeinsame Abendstunden mit Familie und Freunden.

Outdoor lighting is much more than just functional!

Integrated rechargeable batteries lets you flexibly use these easily transportable lights to accent your garden, balcony or terrace in an exciting way, all without any cables! Additional highlights like an RGB colour wheels and Bluetooth for streaming music wirelessly provide just the right mood. The perfect lighting for spending evening hours with family and friends.

L'éclairage extérieur est bien plus que simplement fonctionnel !

Grâce à la batterie rechargeable intégrée, les lampes transportables sont flexibles et mettent des accents excitants dans le jardin, sur le balcon ou la terrasse –

sans aucun câble ! D'autres fonctions marquantes garantissent une bonne ambiance, telles que le changeur de couleurs RVB ou la fonction Bluetooth pour l'écoute de musique sans fil. L'éclairage parfait pour les soirées partagées avec la famille et les amis.

Buitenverlichting is veel meer dan enkel nuttig!

Dankzij de geïntegreerde accu zijn de verplaatsbare lampen flexibel en zorgen voor mooie accenten in de tuin, op het balkon of op het terras, en dat helemaal zonder kabel! Voor de juiste stemming zorgen extra hoogtepunten zoals de RGB-kleurenwisselaar of Bluetooth-functie om draadloos muziek te beluisteren. De perfecte verlichting om 's avonds aangenaam te vertoeven met vrienden en familie.

¡La iluminación exterior es mucho más que algo funcional!

Gracias a la batería integrada, las luces transportables son flexibles y aportan puntos de atención excitantes al jardín, al balcón o a la terraza - ¡y sin ningún tipo de cables! Se consigue el ambiente adecuado con otras características especiales adicionales como el modificador de color RGB o la función Bluetooth para escuchar música sin cables. La iluminación perfecta para pasar la tarde con la familia y los amigos.



L'illuminazione esterna è molto più che funzionale!

Grazie alla batteria ricaricabile integrata, le lampade portatili sono flessibili e creano accenti emozionanti in giardino, sul balcone o sulla terrazza - senza cavi! Ulteriori punti di forza come il cambiacolori RGB o la funzione Bluetooth per l'ascolto di musica senza fili assicurano il giusto feeling. L'illuminazione perfetta per le ore serali da trascorrere insieme alla famiglia e agli amici.

Iluminarea exterioară este mult mai mult decât funcțională!

Datorită acumulatorului integrat, lămpile transportabile sunt flexibile și oferă un aspect atrăgător în grădină, pe balcon sau pe terasă - fără cablu! Atmosfera potrivită este asigurată de jocurile suplimentare de lumină cum ar fi schimbarea culorilor RGB sau funcția Bluetooth pentru a asculta muzică fără cablu. Iluminarea perfectă pentru orele de seară cu familia și prietenii.

Ulkovalaistus on paljon muutakin kuin vain toimintaa!

Integroidun ladattavan akun ansiosta siirrettävät valaisimet ovat joustavia ja muodostavat jännittäviä korostuksia puutarhaan, parvekkeelle tai terassille – ilman kaapeleita! Lisäkorostukset, kuten RGB-värvivaihtajat tai Bluetooth-toiminto langattomaan musiikin kuuntelun, takaavat oikean ilmapiirin. Täydellinen valaistus illanviettoon yhdessä perheen ja ystävien kanssa.

Oświetlenie zewnętrzne to znacznie więcej niż tylko funkcjonalność!

Dzięki akumulatorowi przenośne lampy są elastyczne w ustawieniu i tworzą ekscytujące akcenty w ogrodzie, na balkonie lub tarasie - bez żadnych kabli! Odpowiedni nastrój zapewnią dodatkowe urządzenia, takie jak zmieniające kolorów RGB lub funkcja Bluetooth do bezprzewodowego słuchania muzyki. Doskonałe oświetlenie wspólnych wieczorów z rodziną i przyjaciółmi.

PALMAS

Kunststoff
 plastic
 plastique
 kunststof
 plástico
 plastica
 plastic
 muovi
 plastik

01 Weiß · white

Incl. 1 x RGBW-LED, 1,5 W
 45 lm, 3.000 K

R55101101

Incl. 1 x RGBW-LED, 3 W
 90 lm, 3.000 K

R45101101

Incl. 1 x RGBW-LED, 4,5 W
 120 lm, 3.000 K

R45101901



R55101101



R45101101



R45101901

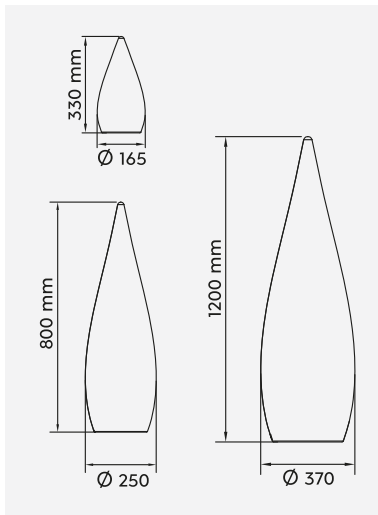

330 mm
 Ø 165

800 mm
 Ø 250

1200 mm
 Ø 370



RGBW Farbwechsler
 RGBW Colorchanging
 Changement de couleur RGBW
 RGBW Kleurverandering
 Cambio de color RGBW
 Cambia colore RGBW
 Schimbator de culoare RGBW
 Värinvaihto RGB
 Zmieniający kolor RGBW



Akkubetrieb
 Rechargeable battery operated
 Fonctionnement sur batteries rechargeable
 Oplaadbare accu
 Batería recargable
 Batteria Ricaricabile
 Operabil prin baterie reincarcabila
 Ladattava akku
 Akumulator zasilany bateryjnje
 Şarj edilebilir pilli



Ladezeit
Charging time
Temps de charge
Oplaaftijd
Tiempo de carga
Tempo di carica
Timp de incarcare
Latausaika
Czas ładowania



Leuchtdauer
Luminous period
Durée d'éclairage
Brandtijd
Tiempo de iluminación
Tempo di durata
Perioada de iluminare
Valaistusaika
Czas świecenia

SANCHEZ

Kunststoff
 plastic
 plastique
 kunststof
 plástico
 plastica
 plastic
 muovi
 plastik

31 Weiß matt · white mat
42 Anthrazit · anthracite

Incl. 1 x SMD-LED, 2,1 W
 450 lm, 3.000 + 4.000 + 5.000 K

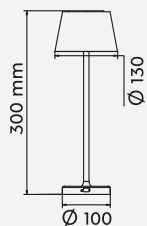
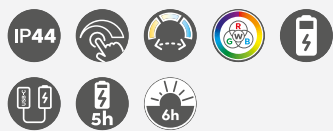

R54126131



R54126142



3.000 K

4.000 K

5.000 K



USB-C Anschluss mit Ladefunktion
 Recharging USB-C connection
 Entrée USB-C de rechargement
 Opladende USB-C aansluiting
 Conexión USB-C de recarga
 Connessione USB-C di ricarica
 Conexiune USB-C reîncărcare
 Lataaminen USB-C-liitäntä
 ładowania USB-C połączenie





MARTINEZ

Metall, Kunststoff
 metal, plastic
 metale, plastique
 metaal, kunststof
 metal, plástico
 metallo, plastica
 metal, plastic
 metalli, muovi
 metal, plastik

- 31** Weiß matt · white mat
- 32** Schwarz matt · black mat
- 77** Ultimate Grau · ultimate grey
- 83** Illuminate Gelb · illuminate yellow

Incl. 1 x SMD-LED, 2,2 W
 250 lm, 2.700 – 6.500 K

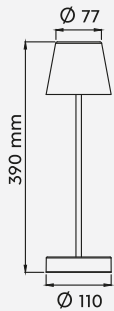

R54086132



R54086131



R54086183

R54086177



Lichtfarbe stufenlos einstellbar
 Light color infinitely variable
 Culoare de lumiere infinit variable
 Lichtkleur traploos instelbaar
 Color de luz infinitamente variable
 Colore della luce infinitamente variabile
 Culoare lumină infinit variabilă
 Valon väri portaattomasti
 Jasny kolor bezstopniowo

Metall, Kunststoff
 metal, plastic
 metals, plastique
 metaal, kunststof
 metal, plástico
 metallo, plastica
 metal, plastic
 metalli, muovi
 metal, plastik

31 Weiß matt · white mat

32 Schwarz matt · black mat

Incl. 1 x SMD-LED, 1,5 W
 130 lm, 2.700 + 4.000 + 6.000 K

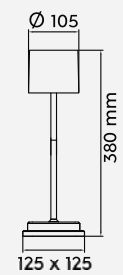

R54096131

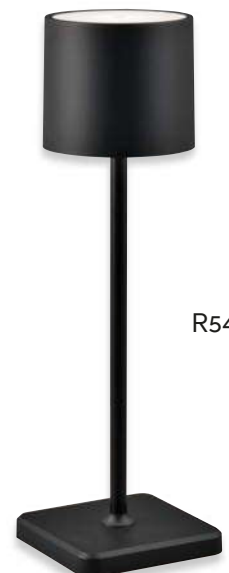

R54096132



Lichtfarbe einstellbar
 Adjustable light color
 Couleur de lumière réglable
 Lichtkleur instelbaar
 Color de luz regulable
 Colore della luce regolabile
 Lumina colorata reglabila
 Värlämpötila säädettävissä
 Regulowana barwa światła



USB-C Anschluss mit Ladefunktion
 Recharging USB-C connection
 Entrée USB-C de rechargement
 Opladende USB-C aansluiting
 Conexión USB-C de recarga
 Connessione USB-C di ricarica
 Conexiune USB-C reîncărcare
 Lataaminen USB-C-liitäntä
 ładowania USB-C połączenie



ELLIOT

Kunststoff
 plastic
 plastique
 kunststof
 plástico
 plastica
 plastic
 muovi
 plastik

- 31** Weiß matt · white mat
- 32** Schwarz matt · black mat
- 49** Pistaziengrün · pistachio green
- 77** Ultimate Grau · ultimate grey
- 83** Illuminate Gelb · illuminate yellow

Incl. 1 x SMD-LED, 2 W
 180 lm, 3.000 K

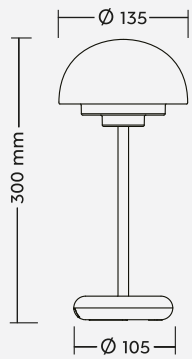
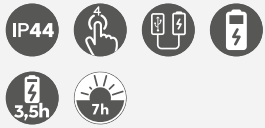

USB-C



R52306149

R52306177



R52306131



R52306132



R52306183

LENNON

Kunststoff
plastic
plastique
kunststof
plástico
plastica
plastic
muovi
plastik

- 01** Weiß · white
- 02** Schwarz · black
- 49** Pistaziengrün · pistachio green
- 77** Ultimate Grau · ultimate grey
- 83** Illuminate Gelb · illuminate yellow

Incl. 1 x SMD-LED, 2 W
180 lm, 3.000 K

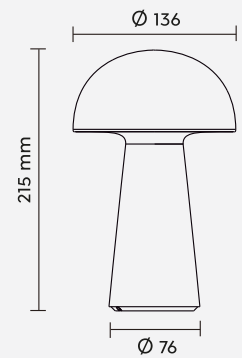

USB-C



R52176101

R52176183



R52176102



R52176149



R52176177



ARUBA

Kunststoff
plastic
plastique
kunststof
plástico
plastica
plastic
muovi
plastik

01 Weiß · white

Incl. 1 x RGBW-LED, 1 W
70 lm, 3.000 K

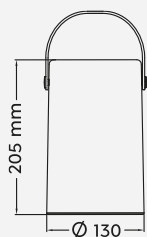

USB Anschluss mit Ladefunktion
Recharging USB connection
Entrée USB de rechargement
Opladende USB aansluiting
Conexión USB de recarga
Connessione USB di ricarica
Conexiune USB reîncărcare
Lataaminen USB-liitäntä
Ładowania USB połączenie
şarj USB baġlantı



Ladezeit
Charging time
Temps de charge
Oplaadtijd
Tiempo de carga
Tempo di carica
Timp de încarcare
Latausaika
Czas ładowania



Leuchtdauer
Luminous period
Durée d'éclairage
Brandtijd
Tiempo de iluminación
Tempo di durata
Perioada de iluminare
Valaistusaika
Czas świecenia

JAMAICA

Kunststoff
plastic
plastique
kunststof
plástico
plastica
plastic
muovi
plastik

01 Weiß · white

Incl. 1 x RGBW-LED, 2,5 W
25 lm, 3.000 K

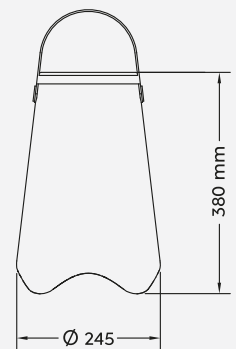

LIGHT & SOUND



R55086101

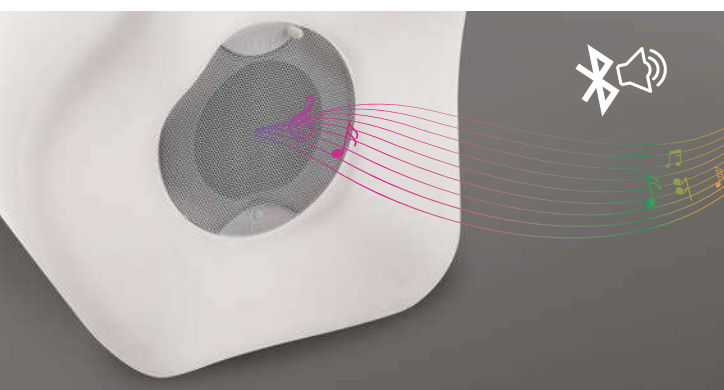

DORA

Kunststoff
plastic
plastique
kunststof
plástico
plastica
plastic
muovi
plastik

01 Weiß · white

Incl. 1 x SMD-LED, 1,5 W
90 lm, 3.000 K

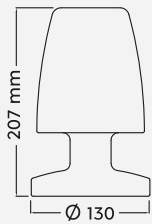

R57051101



Ladezeit
Charging time
Temps de charge
Oplaadtijd
Tiempo de carga
Tempo di carica
Timp de incarcare
Latausaika
Czas ładowania



Leuchtdauer
Luminous period
Durée d'éclairage
Brandtijd
Tiempo de iluminación
Tempo di durata
Perioada de iluminare
Valaistusaika
Czas świecenia

Kunststoff
 plastic
 plastique
 kunststof
 plástico
 plastica
 plastic
 muovi
 plastik

01 Weiß · white

Incl. 1 x SMD-LED, 1,5 W
 90 lm, 3.000 K

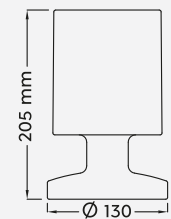

R57071101



Akkubetrieb
 Rechargeable battery operated
 Fonctionnement sur batteries rechargeable
 Oplaadbare accu
 Batería recargable
 Batteria Ricaricabile
 Operabil prin baterie reincarcabila
 Ladattava akku
 Akumulator zasilany baterijnie



USB Anschluss mit Ladefunktion
 Recharging USB connection
 Entrée USB de rechargement
 Opladende USB aansluiting
 Conexión USB de recarga
 Connessione USB di ricarica
 Conexiune USB reîncărcare
 Lataaminen USB-liitäntä
 ładowania USB połączenie

BOLO

Kunststoff
plastic
plastique
kunststof
plástico
plastica
plastic
muovi
plastik

01 Weiß · white

Excl. 1 x E27, max. 23 W

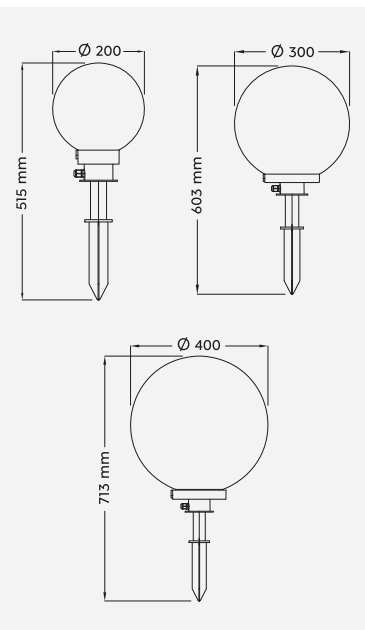

R57043001



R57042001



R57044001

Empfohlen:
recommended:

LED E27, 4,9 W
470 lm, 3.000 K



987-60







Sonne Tanken!

Solarleuchten nutzen ausschließlich die Kraft der Sonne um Licht zu erzeugen. Dabei sind sie extrem umwelt-schonend, sparsam und gleichermaßen praktisch, da sie weder Steckdosen noch einen Anschluss ans Stromnetz benötigen. In Kombination mit moderner LED-Technik bieten Solarleuchten ideales Licht für Haus und Garten.

Soak up the sun!

Solar lamps exclusively use the power of the sun to generate light. At the same time they are extremely environmentally friendly and economical as well as practical, as they need neither sockets nor a connection to the mains supply. In combination with modern LED technology, solar lamps provide an ideal light for home and garden.

Faites le plein de soleil !

Les lampes solaires utilisent exclusivement l'énergie du soleil pour générer de la lumière. En même temps, elles sont extrêmement écologiques, économiques et tout aussi pratiques, car elles ne nécessitent ni prise de courant ni raccordement au réseau électrique. En combinaison avec la technologie LED moderne, les lampes solaires fournissent une lumière idéale pour la maison et le jardin.

Doe zon op!

Zonnelampen maken uitsluitend gebruik van de kracht van de zon om licht te produceren. Daarbij zijn ze extreem milieuvriendelijk, zuinig en in gelijke mate praktisch, omdat ze noch een stopcontact noch een aansluiting op het stroomnet nodig hebben. In combinatie met moderne ledtechniek bieden z onnelampen ideaal licht voor huis en tuin.

¡Disfrute del sol!

Las luces solares usan exclusivamente la energía del sol para generar luz. Al mismo tiempo, son extremadamente ecológicas, económicas e igualmente prácticas, y no necesitan ni enchufes ni conexión a la corriente. En combinación con las modernas técnicas LED, las luces solares ofrecen una luz ideal para la casa y el jardín.



Prendete un po' di sole!

Le lampade solari utilizzano esclusivamente la potenza del sole per generare luce. Allo stesso tempo sono estremamente rispettose dell'ambiente, economiche e pratiche in quanto non richiedono né presa di corrente, né un collegamento alla rete elettrica. In combinazione con la moderna tecnologia LED, le lampade solari forniscono una luce ideale per la casa e il giardino.

Alimentați cu soare!

Lămpile solare se folosesc în exclusivitate de energia soarelui pentru a genera lumină. În acest context sunt extrem de ecologice, economice și practice în același timp, deoarece nu necesită nici prize și nici conectarea la o rețea electrică. În combinație cu tehnologia modernă LED, lămpile solare oferă lumina ideală pentru casă și grădină.

Ajattele aurinkoa!

Aurinkovalaisimet käyttävät auringon energiaa valon tuottamiseen. Samalla ne ovat erittäin ympäristöystävällisiä, taloudellisia ja myös käytännöllisiä, koska ne eivät vaadi pistorasioita tai liitäntää sähköverkkoon. Yhdessä modernin LED-tekniikan kanssa aurinkovalaisimet tarjoavat ihanteellisen valaistuksen kotiin ja puutarhaan.

Nałapać energii słonecznej!

Lampy solarne wykorzystują moc słońca do generowania światła. Są one przy tym niezwykle przyjazne dla środowiska, ekonomiczne i jednocześnie praktyczne, ponieważ nie wymagają gniazd ani podłączenia do sieci elektrycznej. W połączeniu z nowoczesną technologią LED lampy solarne zapewniają idealne oświetlenie domu i ogrodu.

CARMO



Aluminium Druckguss, Kunststoff
 diecast aluminium, plastic
 fonte d'aluminium, plastique
 gegoten aluminium, kunststof
 aluminio fundido, plástico
 pressofusione di alluminio, plastica
 fonta aluminiu, plastic
 valualumiini, muov
 barwione aluminium, plastik

32 Schwarz matt · black mat

Incl. 1 x SMD-LED, 2 W
 130 lm, 3.000 K

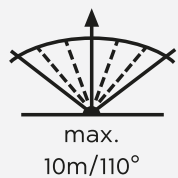
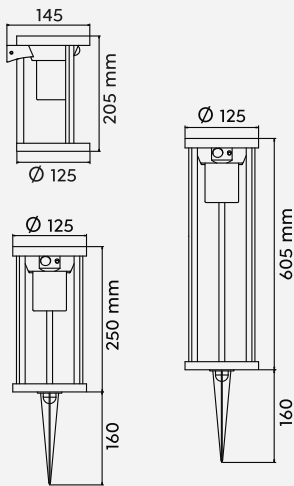

241069132



541069132

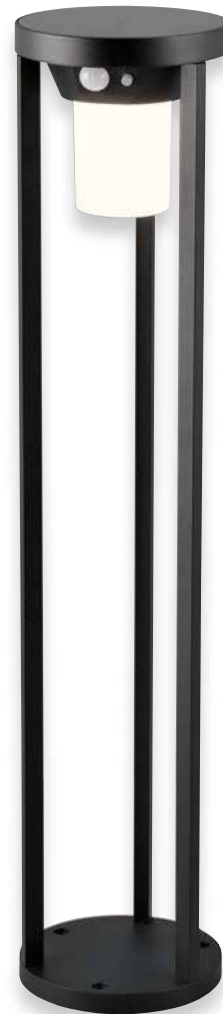

441069132



Bewegungssensor und Orientierungslicht
 Motion sensor and orientation light
 Capteur de mouvement et lumière d'orientation
 Bewegungssensor en oriëntatielicht
 Lámpara con sensor de movimiento y de orientación
 Sensore di movimento e luce di orientamento
 Senzor de mișcare și lumină de orientare
 Liiketunnistin ja suuntavalo
 Czujnik ruchu i światło orientacyjne





Kunststoff
 plastic
 plastique
 kunststof
 plástico
 plastica
 plastic
 muovi
 plastik

42 Anthrazit · anthracite

Incl. 1 x SMD-LED, 4,5 W
 290 lm, 3.000 K



R22251142



R42251142

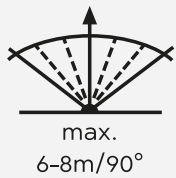
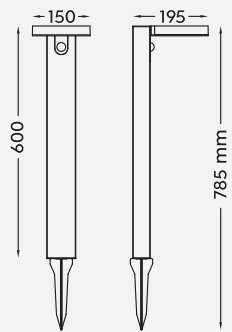
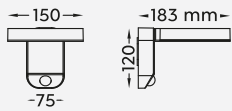

Ladezeit
 Charging time
 Temps de charge
 Oplaadtijd
 Tiempo de carga
 Tempo di carica
 Timp de incarcare
 Latausaika
 Czas ładowania



Leuchtdauer
 Luminous period
 Durée d'éclairage
 Brandtijd
 Tiempo de iluminación
 Tempo di durata
 Perioada de iluminare
 Valaistusaika
 Czas świecenia

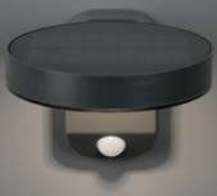



Kunststoff
 plastic
 plastique
 kunststof
 plástico
 plastica
 plastic
 muovi
 plastik

42 Anthrazit · anthracite

Incl. 1 x SMD-LED, 4,5 W
 290 lm, 3.000 K

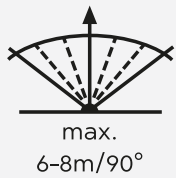
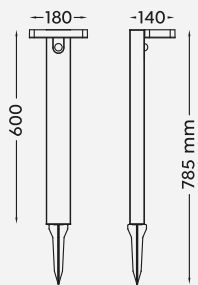
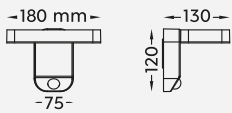

R22261142



R42261142



Ladezeit
 Charging time
 Temps de charge
 Oplaadtijd
 Tiempo de carga
 Tempo di carica
 Timp de incarcare
 Latausaika
 Czas ładowania



Leuchtdauer
 Luminous period
 Durée d'éclairage
 Brandtijd
 Tiempo de iluminación
 Tempo di durata
 Perioada de iluminare
 Valaistusaika
 Czas świecenia



Kunststoff
 plastic
 plastique
 kunststof
 plástico
 plastica
 plastic
 muovi
 plastik

42 Anthrazit · anthracite

Incl. 1 x SMD-LED, 5 W
 200 lm, 3.000 K

R22241142



Incl. 1 x SMD-LED, 4,8 W
 340 lm, 3.000 K

R22281142

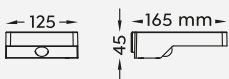

MENDOZA

R22241142



FOMOSA

R22281142

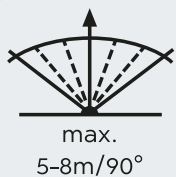

Ladezeit
 Charging time
 Temps de charge
 Oplaadtijd
 Tiempo de carga
 Tempo di carica
 Timp de încarcare
 Latausaika
 Czas ładowania

SALTA

Metall, Acryl
 metal, acryl
 metale, acryl
 metaal, acryl
 metal, acrílico
 metallo, acrilico
 metal, acrilic
 metalli, akryyli
 metal, akryl

07 Nickel matt · nickel mat

42 Anthrazit · anthracite

Incl. 1 x SMD-LED, 3 W
 165 lm, 3.000 K



R22231107

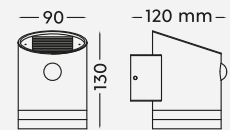

R22231142



Leuchtdauer
 Luminous period
 Durée d'éclairage
 Brandtijd
 Tiempo de iluminación
 Tempo di durata
 Perioada de iluminare
 Valaistusaika
 Czas świecenia

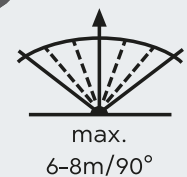

SILVA

Kunststoff
plastic
plastique
kunststof
plástico
plastica
plastic
muovi
plastik

01 Weiß · white

Incl. 1 x SMD-LED, 0,1 W

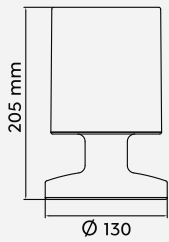

R54076101



Ladezeit
Charging time
Temps de charge
Oplaadtijd
Tiempo de carga
Tempo di carica
Timp de incarcare
Latausaika
Czas ładowania



Leuchtdauer
Luminous period
Durée d'éclairage
Brandtijd
Tiempo de iluminación
Tempo di durata
Perioada de iluminare
Valaistusaika
Czas świecenia



USB-C



R54066101

Kunststoff
 plastic
 plastique
 kunststof
 plástico
 plastica
 plastic
 muovi
 plastik

01 Weiß · white

Incl. 1 x RGBW-LED, 0,1 W

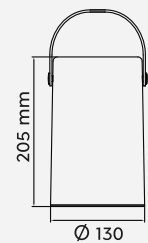
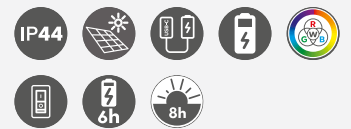

USB-C Anschluss mit Ladefunktion
 Recharging USB-C connection
 Entrée USB-C de rechargement
 Opladende USB-C aansluiting
 Conexión USB-C de recarga
 Connessione USB-C di ricarica
 Conexiune USB-C reîncărcare
 Lataaminen USB-C-liitäntä
 ładowania USB-C połączenie



RGBW Farbwechsler
 RGBW Colorchanging
 Changement de couleur RGBW
 RGBW Kleurverandering
 Cambio de color RGBW
 Cambia colore RGBW
 Schimbator de culoare RGBW
 Värinvaihto RGB
 Zmieniający kolor RGBW



MINEROS

Kunststoff
 plastic
 plastique
 kunststof
 plástico
 plastica
 plastic
 muovi
 plastik

11 Grau · grey

Incl. SMD-LED, 0,02 W

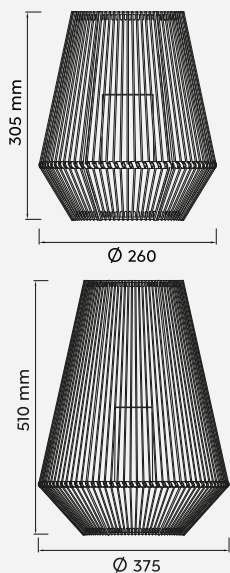

R55256111

R55256911



Flammen-Effekt
 Flame effect
 Effet de flamme
 Vlammeneffect
 Efecto de llamas
 Effetto fiamma
 Efect de flacără
 Liekkitehoste
 Efekt płomienia



Leuchtdauer
 Luminous period
 Durée d'éclairage
 Brandtijd
 Tiempo de iluminación
 Tempo di durata
 Perioada de iluminare
 Valaistusaika
 Czas świecenia



SANTANA

Aluminium Druckguss, Kunststoff
diecast aluminium, plastic
fonte d'aluminium, plastique
gegoten aluminium, kunststof
aluminio fundido, plástico
pressofusione di alluminio, plastica
fonta aluminiu, plastic
valualumiini, muovi
barwione aluminium, plastik

32 Schwarz matt / Braun ·
black mat / brown

Incl. 1 x SMS-LED, 0,1 W

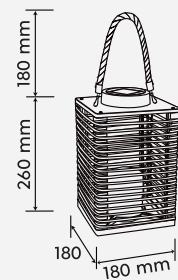

R55346132



Leuchtdauer
Luminous period
Durée d'éclairage
Brandtijd
Tiempo de iluminación
Tempo di durata
Perioada de iluminare
Valaistusaika
Czas świecenia



Ladezeit
Charging time
Temps de charge
Oplaadtijd
Tiempo de carga
Tempo di carica
Timp de incarcare
Latausaika
Czas ładowania



MAIRANA

Metall
metal
metale
metaal
metal
metallo
metal
metalli
metal

32 Schwarz matt · black mat

Incl. 1 x SMS-LED, 0,1 W

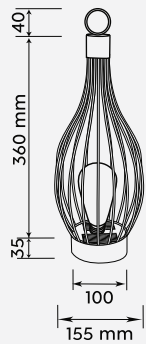

Dämmerungssensor
Dusk sensor
Décteur de crépuscule
Schemeringsensor
Sensor de oscuridad
Sensore crepuscolare
Senzor de lumina/amurg
Hämärätunnistin
Czujnik zmierzchowy



Ladezeit
Charging time
Temps de charge
Oplaadtijd
Tiempo de carga
Tempo di carica
Timp de incarcare
Latausaika
Czas ładowania



R55316132

Metall
metal
metale
metaal
metal
metallo
metal
metalli
metal

32 Schwarz matt · black mat

Incl. SMD-LED, 0,01 W

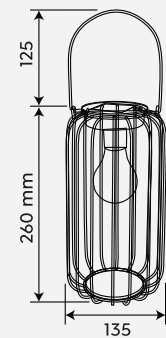

Dämmerungssensor
Dusk sensor
Décteur de crépuscule
Schemeringsensor
Sensor de oscuridad
Sensore crepuscolare
Senzor de lumina/amurg
Hämärätunnistin
Czujnik zmierzchowy



Leuchtdauer
Luminous period
Durée d'éclairage
Brandtijd
Tiempo de iluminación
Tempo di durata
Perioada de iluminare
Valaistusaika
Czas świecenia

SONORA

Metall
metal
metale
metaal
metal
metallo
metal
metalli
metal

32 Schwarz matt · black mat

Incl. 1 x SMD-LED, 0,02 W

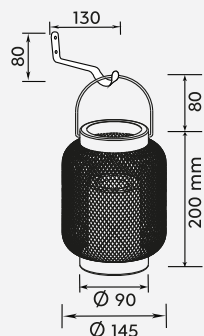

Ladezeit
Charging time
Temps de charge
Oplaadtijd
Tiempo de carga
Tempo di carica
Timp de incarcare
Latausaika
Czas ładowania



Leuchtdauer
Luminous period
Durée d'éclairage
Brandtijd
Tiempo de iluminación
Tempo di durata
Perioada de iluminare
Valaistusaika
Czas świecenia



Dämmerungssensor
Dusk sensor
Décteur de crépuscule
Schemeringsensor
Sensor de oscuridad
Sensore crepuscolare
Senzor de lumina/amurg
Hämärätunnistin
Czujnik zmierzchowy

MERIDA



Metall
metal
metale
metaal
metal
metallo
metal
metalli
metal

32 Schwarz matt · black mat

Incl. 1 x SMD-LED , 0,08 W

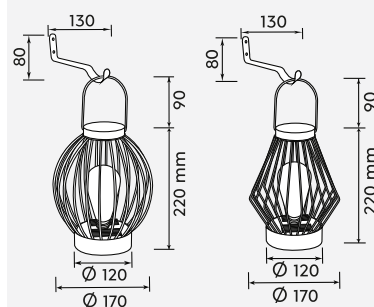

R54046132



R54036132



CORO

Metall, Kunststoff
metal, plastic
metale, plastique
metaal, kunststof
metal, plástico
metallo, plastica
metal, plastic
metalli, muovi
metal, plastik

32 Schwarz matt · black mat

Incl. SMD-LED, 0,2 W

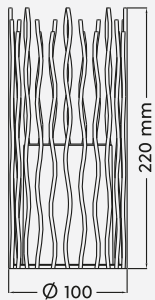

R55136132



Flammen-Effekt
Flame effect
Effet de flamme
Vlammeneffect
Efecto de llamas
Effetto fiamma
Efect de flacără
Liekkitehoste
Efekt płomienia



Ladezeit
Charging time
Temps de charge
Oplaaadtijd
Tiempo de carga
Tempo di carica
Timp de incarcare
Latausaika
Czas ładowania



Leuchtdauer
Luminous period
Durée d'éclairage
Brandtijd
Tiempo de iluminación
Tempo di durata
Perioada de iluminaře
Valaistus aika
Czas świecenia

Metall, Kunststoff
 metal, plastic
 metale, plastique
 metaal, kunststof
 metal, plástico
 metallo, plastica
 metal, plastic
 metalli, muovi
 metal, plastik

32 Schwarz matt · black mat

Incl. SMD-LED, 0,1 W

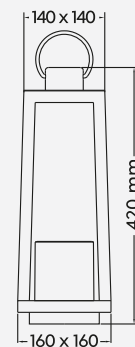

R55176132



Ladezeit
 Charging time
 Temps de charge
 Oplaadtijd
 Tiempo de carga
 Tempo di carica
 Timp de incarcare
 Latausaika
 Czas ładowania



Leuchtdauer
 Luminous period
 Durée d'éclairage
 Brandtijd
 Tiempo de iluminación
 Tempo di durata
 Perioada de iluminare
 Valaistusaika
 Czas świecenia

MELO

Kunststoff
plastic
plastique
kunststof
plástico
plastica
plastic
muovi
plastik

01 Weiß · white

Incl. 1 x RGBW-LED, 0,5 W

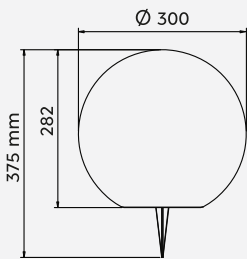
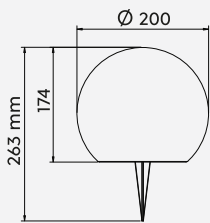
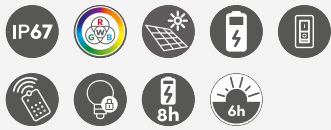

R55326901

R55326101



RGBW Farbwechsler
RGBW Colorchanging
Changement de couleur RGBW
RGBW Kleurverandering
Cambio de color RGBW
Cambia colore RGBW
Schimbator de culoare RGBW
Värvaihto RGB
Zmieniający kolor RGBW

CAMPUS



Metall, Kunststoff
metal, plastic
metale, plastique
metaal, kunststof
metal, plástico
metallo, plastica
metal, plastic
metalli, muovi
metal, plastik

32 Schwarz matt · black mat

Incl. 3 x SMD-LED, 0,1 W

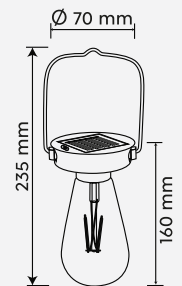

R35146132



Ladezeit
Charging time
Temps de charge
Oplaadtijd
Tiempo de carga
Tempo di carica
Timp de incarcare
Latausaika
Czas ładowania



Leuchtdauer
Luminous period
Durée d'éclairage
Brandtijd
Tiempo de iluminación
Tempo di durata
Perioada de iluminare
Valaistus aika
Czas świecenia



3er Set / Set 3

Produkteigenschaften · Features

Caractéristiques · Kenmerken · Acabados ·
Caratteristiche · Caracteristici · Ominaisuudet · Cechy



Schalter · Switch
Interrupteur · Schakelaar · Interruptor ·
Interruttore · Intrerupator · Kytkin ·
Przełącznik



Fernbedienung · Remote control
Commande à distance · Afstandsbediening ·
Mando a distancia · Comando a distanza ·
Telecomanda · Kauko-ohjain · Pilot



Integrierter Dimmer · Integrated dimmer
Variateur intégré · Geïntegreerde dimmer ·
Regulador integrado · Dimmer integrato ·
Variator de lumina integrat · Integroitu himmennin ·
Wbudowany ściemniacz



RGBW Farbwechsler · RGBW Colorchanging
Changement de couleur RGBW ·
RGBW Kleurverandering · Cambio de color RGBW ·
Cambia colore RGBW · Schimbator de culoare
RGBW · Värvinvaihto RGB · Zmieniający kolor RGBW



RGB Farbwechsler · RGB Colorchanging
Changement de couleur RGB ·
RGB Kleurverandering · Cambio de color RGB ·
Cambia colore RGB · Schimbator de culoare RGB ·
Värvinvaihto RGB · Zmieniający kolor RGB



Schwenkbar · Tilttable
Pivotant · Draaibaar · Pivotante ·
Girevole · Pivotant · Suunnattava · Skräpny



Steckdose · Plug
Prise · Stekker · Enchufe · Spina ·
Priza · Katkaisin · Gniazdko



Bewegungssensor · Motion sensor
Détecteur de mouvement · Bewegungssensor ·
Sensor de movimiento · Sensore di movimento ·
Senzor de mișcare · Liiketunnistin · Czujnik ruchu



Dämmerungssensor · Dusk sensor
Décteur de crépuscule · Schemeringsensor ·
Sensor de oscuridad · Sensore crepuscolare ·
Senzor de lumina/amurg · Hämärätunnistin ·
Czujnik zmierzchowy



4 fach TOUCH · 4 level Touch function
Interrupteur tactile 4 niveaux ·
Touch schakelaar 4 niveaus · Función Táctil 4 nivel ·
Interruttore touch 4 livelli · Intrerupator tactil
4 nivele · Kosketuskäyttöinen 4 taso ·
Funkcja dotykowa 4 poziomy



Up and down Beleuchtung ·
Up and Down lighting
Point lumineux en haut et en bas · Lichtpunt boven
en onder · Luz de arriba y abajo · Luce su e giù ·
Sus și în jos lumina · Ylös ja alas valoa ·
W górę iw dół światło



Lichtfarbe stufenlos einstellbar ·
Light color infinitely variable
Couleur de lumière infiniment variable ·
Lichtkleur traploos instelbaar · Color de luz
infinitamente variable · Colore della luce
infinitamente variabile · Culoare lumină infinit
variabilă · Valon väri portaattomasti ·
Jasny kolor bezstopniowo



Ohne Leuchtmittel · Lamp(s) excluded
Sans ampoule(s) · Zonder lichtbron(nen) ·
Sin bombilla(s) · Lampadina Esclusa · Fara bec (s) ·
Ilman polttimo (s) · Bez żarówki (s)



Timer · Timer
Minuterie · Timer · Temporizador · Timer ·
Temporizator · Ajastin · Timer



Helligkeit einstellbar · Adjustable light level
Niveau d'éclairage ajustable · Instelbaar
lichtniveau · Nivel de luz ajustable · Livello di luce
regolabile · Nivelul de lumina reglabil · Säädettävä
valo taso · Regulowana jasność światła



Bluetooth Lautsprecher ·
Bluetooth loudspeaker
Haut-parleur bluetooth · Bluetooth luidspreker ·
Altavoz de bluetooth · Altoparlante bluetooth ·
Difuzor Bluetooth · Bluetooth-kaiutin ·
Głośnik Bluetooth



USB Anschluss · USB connection
Entrée USB · USB aansluiting · Conexión USB ·
Connessione USB · Conexiune USB ·
USB-liitäntä · Połączenie USB



USB Anschluss mit Ladefunktion ·
Recharging USB connection
Entrée USB de rechargement · Opladende USB
aansluiting · Conexión USB de recarga ·
Connessione USB di ricarica · Conexiune USB
reîncărcare · Lataaminen USB-liitäntä ·
ładowania USB połączenie



Memory Funktion · Memory function
fonction mémoire · Geheugen functie ·
Función de memoria · Funzione memorizzazione ·
functia memorie · Muistitoiminto · Funkcja pamięci



Akkubetrieb · Rechargeable battery operated
Fonctionnement sur batteries rechargeable ·
Oplaadbare accu · Batería recargable ·
Batteria Ricaricabile · Operabil prin baterie
reincarcabila · Ladattava akku ·
Akumulator zasilany bateryjnie



Batteriebetrieb · Battery operated
Fonctionnement sur batterie · Werkt op batterijen ·
Funcionamiento con batería · Funzionamento a
batteria · Funcționare cu baterie · Käyttöaika ·
Zasilana na baterie



Solar · Solar
Solaire · Solair · Solar · Solare ·
Solar · Aurinkokenno · Solar



Ladezeit · Charging time
Temps de charge · Oplaadtijd · Tiempo de carga ·
Tempo di carica · Timp de încarcare · Latausaika ·
Czas ładowania



Leuchtdauer · Luminous period
Durée d'éclairage · Brandtijd · Tiempo de
iluminación · Tempo di durata · Perioada de
iluminare · Valaistusaika · Czas świecenia



Flammen-Effekt · Flame effect
Effet de flamme · Vlammeneffect · Efecto de
llamas · Effetto fiamma · Efect de flacăra ·
Liekkitehoste · Efekt płomienia



Abstrahlwinkel · Emission angle
Angle de rayonnement · Uitstraalhoek ·
Ángulo de emisión · Angolo di emissione ·
Unghiul de emisii · Säteilukulma · Kaḡ emisji



Belastbarkeit · Resilience
Limite de charge · Belastbaarheid · Resistencia ·
Resistenza · Reziștenḡa la solicitare ·
Kuormittettavuus · Nořnořć



Bewegungssensor und Orientierungslicht.
Die Leuchte verfügt über ein Orientierungslicht, das sich bei Dämmerung oder Dunkelheit automatisch einschaltet.
Wird eine Bewegung erfasst, schaltet die Leuchte von Orientierungslicht auf volle Lichtleistung

Motion sensor and orientation light .
The luminaire has an orientation light that switches on automatically at dusk or in the dark.
If movement is detected, the luminaire switches from orientation light to full light output.

Captur de mouvement et lumière d'orientation.
Le luminaire est muni d'une lumière d'orientation qui s'allume automatiquement dès qu'il fait sombre ou dans le noir.
Si un mouvement est détecté, le luminaire passe de la lumière d'orientation à la lumière maximale.

Bewegingssensor en oriëntatielicht.
Het verlichtingstoestel heeft een oriëntatielicht dat automatisch inschakelt bij schemerdonker of in het donker.
Wanneer beweging waargenomen wordt, schakelt het verlichtingstoestel over van oriëntatielicht naar volledig lichtvermogen.

Lámpara con sensor de movimiento y de orientación.
La lámpara dispone de una luz de orientación que se enciende automáticamente al anoecer o en la oscuridad.
Si se detecta movimiento, la lámpara pasa de luz de orientación a plena potencia luminosa.

Sensore di movimento e luce di orientamento.
La lampada è dotata di una luce di orientamento che si accende automaticamente al crepuscolo o al buio.
Se viene rilevato un movimento, la lampada passa dalla luce di orientamento alla piena emissione di luce.

Senzor de miřcare ři lumină de orientare.
Corpul de iluminat are o lumină de orientare care se pornește automat în amurg sau în întuneric.
Dacă este detectată miřcare, corpul de iluminat trece de la lumina de orientare la iluminat deplin.

Liiketunnistin ja suuntavalo.
Valaisimessa on suuntavalo, joka syttyy automaattisesti illansarastuksessa tai pimeään laskiessa.
Jos liikettä havaitaan, valaisin siirtyy suuntavalosta täyteen valaistustehoon.

Czujnik ruchu i światło orientacyjne.
Oprawa posiada światło orientacyjne, które włącza się automatycznie o zmierzchu lub w ciemności.
W przypadku wykrycia ruchu oprawa przełącza się ze światła orientacyjnego na pełną moc świetlną.



Lichtfarbe einstellbar · Adjustable light color
Couleur de lumière réglable · Lichtkleur instelbaar ·
Color de luz regulable · Colore della luce regolabile ·
Lumina colorata reglabila · Värilämpötila säädettävissä · Regulowana barwa światła



DIP SWITCH
Lichtfarben direkt an der Leuchte einstellbar ·
Colours directly adjustable at the lamp
Les couleurs de la lumière peuvent être réglées
directement sur le luminaire · Lichtkleuren direct
instelbaar op de lamp · Tonalidades de luz
ajustables directamente en la lámpara · Colori della
luce regolabili direttamente sulla lampada · Colori
ale luminii reglabile direct de la bec · Valon väri
asetettävissä suoraan valaisimesta · Barwy światła
można ustawić bezpośrednio na oprawie



Sensordimmer · Sensor dimmer
Variateur tactile · Touchdimmer ·
Regulador con sensor · Touchdimmer ·
Variator cu senzor · Kosketushimmennin ·
Czujnik ściemniania



USB-C Anschluss mit Ladefunktion ·
Recharging USB_c connection
Entrée USB-C de rechargement · Opladende
USB-C aansluiting · Conexión USB-C de recarga ·
Connessione USB-C di ricarica · Conexiune USB-C
reîncărcare · Lataaminen USB-C-liitäntä ·
ładowania USB-C połączenie

Farben & Materialien · Colours and materials

Couleurs et matériaux · Kleuren en materialen · Colores y materiales · Colori e materiali ·
Culori si materiale · Värit ja materiaalit · Kolory i materiały

01 Weiß · white

blanc · wit · blanco · bianco · alb · valkoinen · biały

02 Schwarz · black

noir · zwart · negro · nero · negru · musta · czarny

07 Nickel matt · nickel mat

nickel mat · nikkel mat · níquel mate · nichel opaco ·
nichel mat · harjattu teräs · nikiel mat

11 Grau · grey

gris · grijs · gris · grigio · gri · harmaa ·
popielaty · gri

24 rostfarbig · rusty

rouille · roestkleur · óxido · ruggine · ruginiu ·
rustiikki · miedź

30 holzfarbig · wood coloured

couleur bois · houtkleur · color madera · colore di legno ·
culoare lemn · puunvärinen · kolor drewna · ahşap renk

31 Weiß matt · white mat

blanc mat · wit mat · estera blanca · bianco opaco ·
alb mat · valkoinen matto · biały mat

32 Schwarz matt · black mat

noir mat · mat zwart · estera negra · nero opaco ·
negru mat · musta matto · czarny mat

42 Anthrazit · anthracite

antracite · antraciet · antracita · antracite · antracit ·
antrasiitti · antracyt

49 Pistaziengrün · pistachio green

vert pistache · pistachegroen · verde pistacho ·
verde pistacchio · verde fistic · pistaasin vihreä ·
zielony pistacjowy

77 Ultimate Grau · ultimate grey

gris ultimate · ulziem grijs · gris absoluto ·
grigio assoluto · gri suprem · ultimaattinen harmaa ·
ciemnoszary

83 Illuminate Gelb · illuminate yellow

jaune illuminate · helder geel · amarillo iluminado ·
giallo brillante · galben strălucitor · hehkuvan keltainen ·
swietlisty żółty

87 titanfarbig · titan

titane · titaan · titán · titano · titaniu ·
titaani · tytanowy

| Seite Page | Artikel-Nr. Product No. | EAN-Nummer EAN-Number | Seite Page | Artikel-Nr. Product No. | EAN-Nummer EAN-Number |
|---------------|----------------------------|--------------------------|---------------|----------------------------|--------------------------|
| 123 | 201760124 | 4017807442021 | 96 | 220060242 | 4017807241525 |
| 123 | 201760142 | 4017807445411 | 26 | 220760142 | 4017807259063 |
| 106 | 201860130 | 4017807492859 | 65 | 220969142 | 4017807259315 |
| 108 | 201860142 | 4017807433210 | 36 | 221160142 | 4017807302004 |
| 108 | 201860242 | 4017807442410 | 34 | 221169142 | 4017807279290 |
| 124 | 201960124 | 4017807442045 | 53 | 221460142 | 4017807490473 |
| 124 | 201960142 | 4017807442052 | 53 | 221460242 | 4017807564037 |
| 118 | 202360124 | 4017807449891 | 98 | 221560142 | 4017807282375 |
| 119 | 202360142 | 4017807442069 | 30 | 221660242 | 4017807291544 |
| 125 | 202760124 | 4017807445589 | 30 | 221669242 | 4017807297614 |
| 125 | 202760142 | 4017807449884 | 28 | 221760142 | 4017807303551 |
| 114 | 204160124 | 4017807413939 | 29 | 221769142 | 4017807303568 |
| 113 | 204160131 | 4017807492408 | 32 | 222060142 | 4017807337624 |
| 112 | 204160142 | 4017807413946 | 90 | 222260124 | 4017807410594 |
| 115 | 204169124 | 4017807492446 | 92 | 222260142 | 4017807382570 |
| 115 | 204169131 | 4017807492422 | 90 | 222260224 | 4017807410587 |
| 115 | 204169142 | 4017807492460 | 92 | 222260242 | 4017807382587 |
| 48 | 204260224 | 4017807519006 | 24 | 222360142 | 4017807384321 |
| 48 | 204260231 | 4017807518986 | 85 | 222860142 | 4017807492590 |
| 48 | 204260242 | 4017807453171 | 76 | 222960131 | 4017807491234 |
| 49 | 204269224 | 4017807519044 | 76 | 222960142 | 4017807491258 |
| 49 | 204269231 | 4017807519020 | 77 | 222960231 | 4017807491319 |
| 48 | 204269242 | 4017807453195 | 76 | 222960242 | 4017807491326 |
| 50 | 206060142 | 4017807490480 | 74 | 222969131 | 4017807491296 |
| 101 | 207269124 | 4017807492613 | 74 | 222969142 | 4017807491272 |
| 100 | 207269131 | 4017807492620 | 74 | 222969231 | 4017807491357 |
| 100 | 207269142 | 4017807492637 | 75 | 222969242 | 4017807491371 |
| 102 | 207360142 | 4017807492675 | 94 | 224060142 | 4017807434330 |
| 104 | 209660130 | 4017807492798 | 94 | 224060242 | 4017807434347 |
| 120 | 210860124 | 4017807529500 | 40 | 225360142 | 4017807481501 |
| 120 | 210860142 | 4017807506129 | 39 | 225369142 | 4017807481525 |
| 121 | 210869124 | 4017807529678 | 22 | 226260142 | 4017807492545 |
| 121 | 210869142 | 4017807506143 | 44 | 226360142 | 4017807492347 |
| 116 | 211060131 | 4017807529456 | 42 | 226369142 | 4017807492354 |
| 116 | 211060142 | 4017807506174 | 57 | 226460231 | 4017807415605 |
| 116 | 211069131 | 4017807529463 | 57 | 226460242 | 4017807415612 |
| 116 | 211069142 | 4017807506198 | 59 | 226560242 | 4017807408539 |
| 88 | 211660132 | 4017807564075 | 68 | 226660242 | 4017807388893 |
| 110 | 212060142 | 4017807529272 | 68 | 226669242 | 4017807388817 |
| 111 | 212069142 | 4017807529289 | 60 | 226860231 | 4017807382822 |
| 79 | 212160242 | 4017807529340 | 60 | 226860242 | 4017807382839 |
| 61 | 212560224 | 4017807564051 | 58 | 226960231 | 4017807382259 |
| 61 | 212560231 | 4017807564068 | 58 | 226960242 | 4017807382266 |
| 61 | 212560232 | 4017807564044 | 84 | 227260142 | 4017807369236 |
| 46 | 214260142 | 4017807529210 | 69 | 227360142 | 4017807369229 |
| 46 | 214260242 | 4017807529234 | 56 | 227560231 | 4017807337570 |
| 46 | 214269142 | 4017807529227 | 56 | 227560242 | 4017807337594 |
| 46 | 214269242 | 4017807529241 | 56 | 227660231 | 4017807337600 |
| 96 | 220060142 | 4017807241501 | 56 | 227660242 | 4017807337617 |

| Seite Page | Artikel-Nr. Product No. | EAN-Nummer EAN-Number | Seite Page | Artikel-Nr. Product No. | EAN-Nummer EAN-Number |
|---------------|----------------------------|--------------------------|---------------|----------------------------|--------------------------|
| 80 | 227760142 | 4017807303537 | 98 | 421560142 | 4017807282399 |
| 62 | 227860242 | 4017807298611 | 98 | 421560242 | 4017807282405 |
| 82 | 228060101 | 4017807281552 | 30 | 421660242 | 4017807291551 |
| 82 | 228060142 | 4017807281569 | 28 | 421760142 | 4017807303582 |
| 70 | 228260101 | 4017807279528 | 32 | 422060142 | 4017807337648 |
| 70 | 228260142 | 4017807279535 | 90 | 422260124 | 4017807410570 |
| 79 | 228360142 | 4017807279610 | 92 | 422260142 | 4017807382600 |
| 54 | 228460242 | 4017807284164 | 24 | 422360142 | 4017807384338 |
| 63 | 228560242 | 4017807356984 | 94 | 424060142 | 4017807434361 |
| 81 | 228669142 | 4017807356656 | 95 | 424067142 | 4017807445404 |
| 64 | 228760142 | 4017807279276 | 40 | 425360142 | 4017807481563 |
| 83 | 228960142 | 4017807259131 | 38 | 425369142 | 4017807481570 |
| 72 | 229160142 | 4017807242126 | 22 | 426260142 | 4017807492576 |
| 55 | 229360242 | 4017807242164 | 44 | 426360142 | 4017807492385 |
| 55 | 229360287 | 4017807242171 | 42 | 426369142 | 4017807492392 |
| 52 | 240660142 | 4017807563979 | 16 | 440969142 | 4017807564020 |
| 73 | 240760142 | 4017807563986 | 164 | 441069132 | 4017807564259 |
| 16 | 240960142 | 4017807563993 | 20 | 470660142 | 4017807529197 |
| 16 | 240969142 | 4017807564006 | 18 | 470669142 | 4017807529203 |
| 164 | 241069132 | 4017807564235 | 66 | 477860142 | 4017807564112 |
| 20 | 270660142 | 4017807529111 | 106 | 501860130 | 4017807492873 |
| 20 | 270660242 | 4017807529159 | 108 | 501860142 | 4017807433234 |
| 18 | 270669142 | 4017807529135 | 118 | 502360124 | 4017807453072 |
| 18 | 270669242 | 4017807529166 | 118 | 502360142 | 4017807453096 |
| 71 | 273360142 | 4017807492750 | 114 | 504160124 | 4017807413977 |
| 66 | 277860142 | 4017807529333 | 112 | 504160142 | 4017807413991 |
| 122 | 301760124 | 4017807447309 | 48 | 504260142 | 4017807453218 |
| 122 | 301760142 | 4017807447323 | 50 | 506060142 | 4017807490497 |
| 106 | 401860130 | 4017807492897 | 102 | 507360142 | 4017807492705 |
| 108 | 401860142 | 4017807433258 | 104 | 509660130 | 4017807492804 |
| 118 | 402360124 | 4017807453102 | 88 | 511660132 | 4017807564082 |
| 118 | 402360142 | 4017807453119 | 110 | 512060142 | 4017807529296 |
| 114 | 404160124 | 4017807413953 | 46 | 514260142 | 4017807529258 |
| 112 | 404160142 | 4017807413960 | 96 | 520060142 | 4017807241563 |
| 48 | 404260142 | 4017807453232 | 26 | 520760142 | 4017807259100 |
| 50 | 406060142 | 4017807490503 | 36 | 521160142 | 4017807351590 |
| 102 | 407360142 | 4017807492729 | 34 | 521169142 | 4017807279313 |
| 104 | 409660130 | 4017807492828 | 30 | 521660242 | 4017807291568 |
| 120 | 410860124 | 4017807529548 | 28 | 521760142 | 4017807303575 |
| 120 | 410860142 | 4017807506167 | 32 | 522060142 | 4017807337631 |
| 116 | 411060142 | 4017807506211 | 90 | 522260124 | 4017807410563 |
| 117 | 411060342 | 4017807506228 | 92 | 522260142 | 4017807382594 |
| 88 | 411660132 | 4017807564099 | 24 | 522360142 | 4017807384345 |
| 110 | 412060142 | 4017807529302 | 94 | 524060142 | 4017807434354 |
| 46 | 414260142 | 4017807529265 | 40 | 525360142 | 4017807481549 |
| 96 | 420060142 | 4017807241792 | 38 | 525369142 | 4017807481556 |
| 26 | 420760142 | 4017807259087 | 22 | 526260142 | 4017807492569 |
| 36 | 421160142 | 4017807351583 | 44 | 526360142 | 4017807492361 |
| 34 | 421169142 | 4017807279306 | 42 | 526369142 | 4017807492378 |

| Seite Page | Artikel-Nr. Product No. | EAN-Nummer EAN-Number | Seite Page | Artikel-Nr. Product No. | EAN-Nummer EAN-Number |
|---------------|----------------------------|--------------------------|---------------|----------------------------|--------------------------|
| 16 | 540969142 | 4017807564013 | 148 | R45101101 | 4017807500295 |
| 164 | 541069132 | 4017807564242 | 148 | R45101901 | 4017807500301 |
| 20 | 570660142 | 4017807529173 | 155 | R52176101 | 4017807496314 |
| 18 | 570669142 | 4017807529180 | 155 | R52176102 | 4017807496338 |
| 66 | 577860142 | 4017807564105 | 155 | R52176149 | 4017807541236 |
| 108 | 601860242 | 4017807442397 | 155 | R52176177 | 4017807541274 |
| 64 | 620160142 | 4017807274905 | 155 | R52176183 | 4017807541229 |
| 86 | 676960131 | 4017807453393 | 154 | R52306131 | 4017807540925 |
| 86 | 676960142 | 4017807453416 | 154 | R52306132 | 4017807540901 |
| 66 | 677860142 | 4017807529326 | 154 | R52306149 | 4017807541014 |
| 128 | 800260142 | 4017807453133 | 154 | R52306177 | 4017807541038 |
| 128 | 800260342 | 4017807453157 | 154 | R52306183 | 4017807540956 |
| 126 | 821660107 | 4017807453287 | 178 | R54026132 | 4017807564198 |
| 127 | 821660207 | 4017807453348 | 179 | R54036132 | 4017807564204 |
| 126 | 821669107 | 4017807453300 | 179 | R54046132 | 4017807564211 |
| 127 | 821669207 | 4017807453379 | 173 | R54066101 | 4017807564266 |
| 129 | 821860142 | 4017807564143 | 172 | R54076101 | 4017807564273 |
| 132 | 9960-07 | 4017807259360 | 152 | R54086131 | 4017807564280 |
| 130 | 9961-11 | 4017807305777 | 152 | R54086132 | 4017807564297 |
| 130 | 9962-11 | 4017807305784 | 152 | R54086177 | 4017807564303 |
| 130 | 9964-42 | 4017807445299 | 152 | R54086183 | 4017807564310 |
| 133 | 9965-32 | 4017807472349 | 153 | R54096131 | 4017807564327 |
| 135 | R20026242 | 4017807529395 | 153 | R54096132 | 4017807564334 |
| 135 | R20026942 | 4017807529418 | 150 | R54126131 | 4017807570571 |
| 145 | R21186131 | 4017807564136 | 150 | R54126142 | 4017807570595 |
| 145 | R21186132 | 4017807564129 | 157 | R55086101 | 4017807444421 |
| 138 | R22052142 | 4017807490428 | 148 | R55101101 | 4017807500271 |
| 138 | R22062142 | 4017807490435 | 180 | R55136132 | 4017807452778 |
| 142 | R22151131 | 4017807453492 | 181 | R55176132 | 4017807452853 |
| 142 | R22151142 | 4017807453546 | 174 | R55256111 | 4017807492064 |
| 171 | R22231107 | 4017807458220 | 174 | R55256911 | 4017807492095 |
| 171 | R22231142 | 4017807452648 | 176 | R55306132 | 4017807529401 |
| 170 | R22241142 | 4017807452662 | 177 | R55316132 | 4017807492262 |
| 166 | R22251142 | 4017807452686 | 182 | R55326101 | 4017807492101 |
| 168 | R22261142 | 4017807452723 | 182 | R55326901 | 4017807492125 |
| 170 | R22281142 | 4017807452754 | 175 | R55346132 | 4017807529425 |
| 140 | R24236142 | 4017807564150 | 160 | R57042001 | 4017807282801 |
| 141 | R24246132 | 4017807564167 | 160 | R57043001 | 4017807282818 |
| 139 | R24256232 | 4017807564174 | 160 | R57044001 | 4017807282825 |
| 139 | R24266232 | 4017807564181 | 158 | R57051101 | 4017807382518 |
| 134 | R27026132 | 4017807529357 | 159 | R57071101 | 4017807325348 |
| 134 | R27036132 | 4017807529364 | 156 | R57080101 | 4017807407556 |
| 136 | R28222631 | 4017807408324 | 144 | R60501031 | 4017807405873 |
| 136 | R28222632 | 4017807411775 | 144 | R60501042 | 4017807405910 |
| 137 | R28232631 | 4017807408317 | 144 | R60502031 | 4017807405927 |
| 137 | R28232632 | 4017807411768 | 144 | R60502042 | 4017807405934 |
| 183 | R35146132 | 4017807529432 | 142 | R62151131 | 4017807405941 |
| 166 | R42251142 | 4017807452709 | 142 | R62151142 | 4017807405989 |
| 168 | R42261142 | 4017807452730 | | | |



TRIO Leuchten GmbH

Gut Nierhof 17
D-59757 Arnsberg
T +49 (0) 2931 9666-0
F +49 (0) 2931 9666-57
info@trio-leuchten.de
www.trio-leuchten.de



Reality Leuchten GmbH

Gut Nierhof 17
D-59757 Arnsberg
T +49 2931 9666-99
F +49 2931 9666-98
info@reality-leuchten.de
www.reality-leuchten.de

BADEN WÜRTTEMBERG, RHEINLAND-PFALZ UND SAARLAND

Antonio De Simone
T +49 (0) 151 5855222
antonio.desimone@trio-leuchten.de

ÖSTERREICH

Wolfgang Melich
T +43 (0) 6605161228
wolfgang.melich@trio-leuchten.de

BAYERN, HESSEN

Martin Kluge
T +49 (0) 171 7300330
martin.kluge@trio-leuchten.de

SCHWEIZ

TRIO Leuchten
T +49 (0) 2931 9666-0
info@trio-leuchten.de

BERLIN, BRANDENBURG, MECKLENBURG-VORPOMMERN, SACHSEN, SACHSEN ANHALT, THÜRINGEN

Jörg Bumke
T +49 (0) 160 7406860
joerg.bumke@trio-leuchten.de

BREMEN, HAMBURG, NIEDERSACHSEN, SCHLESWIG-HOLSTEIN

Jens Gebers
T +49 (0) 170 1615227
jens.gebers@trio-leuchten.de

NORDRHEIN-WESTFALEN

Christian Teller
T +49 (0) 171 4521820
christian.teller@trio-leuchten.de

TRIO International GmbH

Gut Nierhof 17
D-59757 Arnsberg
T +49 (0) 2931 9666-587
F +49 (0) 2931 9666-56
info@trio-lighting.com
www.trio-lighting.com

FRANCE

Stéphane Papierny

Directeur Commercial France
info.france@trio-lighting.com

Jean Philippe Bailly

info.france@trio-lighting.com
Agent exclusif pour les départements
60, 75 Nord, 92, 93 et 95

Jean Barel / Thomas Wroz

info.france@trio-lighting.com
Agent exclusif pour les départements
09, 12, 15, 16, 19, 23, 24, 31, 32, 33, 40,
46, 47, 64, 65, 81, 82 et 87

Jean Marc Beneforti

info.france@trio-lighting.com
Agent exclusif pour les départements
2a et 2b

Christophe Meulien

info.france@trio-lighting.com
Agent exclusif pour les départements
04, 05, 06, 11, 13, 30, 34, 66, 83 et 84

Sullivan Nicolas

info.france@trio-lighting.com
Agent exclusif pour les départements
01, 03, 07, 21, 23, 26, 38, 39, 42,
43, 48, 63, 69, 71, 73 et 74

Stéphane Riebel

info.france@trio-lighting.com
Agent exclusif pour les départements
18, 45, 58, 75 Sud, 77, 78, 89, 91 et 94

Michel Salamand

info.france@trio-lighting.com
Agent exclusif pour les départements
14, 17, 22, 29, 35, 36, 37, 41, 44, 49, 50,
53, 56, 61, 72, 79, 85 et 86

Elsa Seron

info.france@trio-lighting.com
Agent exclusif pour les départements
27, 28 et 76

Vincent Zaepffel

info.france@trio-lighting.com
Commercial pour les départements
02, 08, 10, 25, 51, 52, 54, 55, 57, 59, 62,
67, 68, 70, 80, 88 et 90

DANMARK

Jan Rantzau-Bartens

info.denmark@trio-lighting.com

SUOMI

TRIO Lighting Scandinavia Oy

Malmin raitti, rappu 17 B
00700 Helsinki
T +358 (0) 10 23 13 390
F +358 (0) 10 23 13 399
info.scandinavia@trio-lighting.com

*Our Scandinavian organisation represents TRIO
also in Sweden, Norway, Estonia, Latvia
and Lithuania*

ITALIA

TRIO Lighting Italia s.r.l

Via Dosso Fatti, 3
22066 Mariano Comense (CO)
T +39 (0) 317 477 55
F +39 (0) 313 551 560
info.italia@trio-lighting.com

ESPAÑA

TRIO Lighting Ibèrica SL

C/ Can Lietget n°9 nave 9
Pol. Ind. Can Roqueta
08206 Sabadell
T +34 (0) 9 35 45 86 30
F +34 (0) 9 33 96 45 48
info.iberica@trio-lighting.com

GREAT BRITAIN

TRIO Lighting UK Ltd.

Unit 5, Hemmells Park Hemmells, Laindon
Essex
SS16 6GF
T +44 (0) 12 68 88 95 95
F +44 (0) 12 68 88 95 96
sales@triolightinguk.com

NEDERLAND

Karl Stok / Bas Martin

info.nederland@trio-lighting.com

BELGIUM/BELGIQUE

Yves van den Berghe

info.belgium@trio-lighting.com

ROMANIA

Gina Ionita

info.romania@trio-lighting.com

OUTDOOR

TRIO Leuchten GmbH

Gut Nierhof 17
D-59757 Arnsberg
T +49 2931 9666-0
F +49 2931 9666-28
info@trio-leuchten.de
www.trio-leuchten.de

Reality Leuchten GmbH

Gut Nierhof 17
D-59757 Arnsberg
T +49 2931 9666-99
F +49 2931 9666-98
info@reality-leuchten.de
www.reality-leuchten.de

TRIO International GmbH

Gut Nierhof 17
D-59757 Arnsberg
T +49 2931 9666-587
F +49 2931 9666-56
info@trio-lighting.com
www.trio-lighting.com

 @trioleuchten

 /trioleuchten

 @trio.lighting

