





FRANKLIN

Metall · metal

1 Tischleuchte · Table lamp

‡ 25 cm, Ø 14 cm
incl. SMD-LED, 6 W
700 lm, 3.000 K



526510104
526510107
526510108
526510142

2 Stehleuchte · Floor lamp

‡ 133 cm, ↔ 23 cm, ↗ 41 cm
incl. SMD-LED, 6,5 W
650 lm, 2.700 + 3.200 + 4.000 K



426510104
426510107
426510108
426510142

3 Stehleuchte · Floor lamp

‡ 181 cm, Ø 35,2 cm
incl. SMD-LED, 35 W
4.100 lm, 2.700 + 3.200 + 4.000 K
incl. SMD-LED, 6,5 W
650 lm, 2.700 + 3.200 + 4.000 K



426510204
426510207
426510208
426510242





-  **04** | Altmessing · old brass
-  **07** | Nickel matt · nickel mat
-  **08** | Messing matt · brass mat
-  **42** | Anthrazit · anthracite



2.700 K

3.200 K

4.000 K

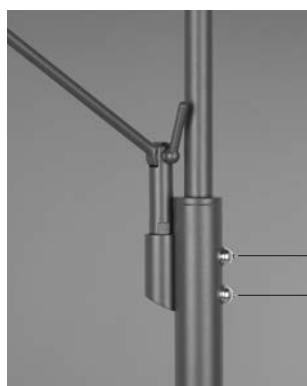

Dimmen und Lichtfarbe einstellen ·
Dimming and adjusting light color

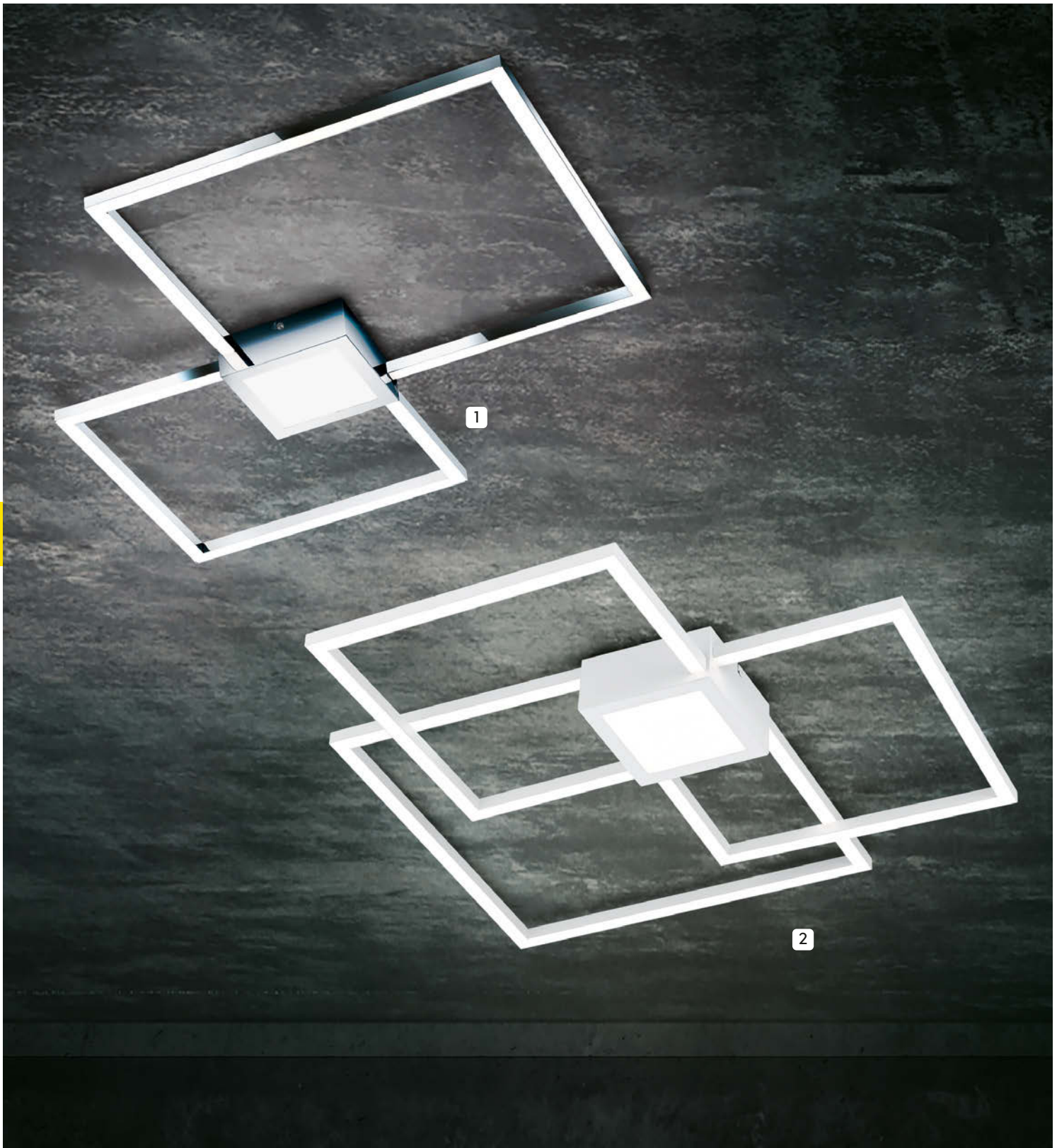

HYDRA

Metall, Chrom oder Weiß matt · metal, chrome or white mat

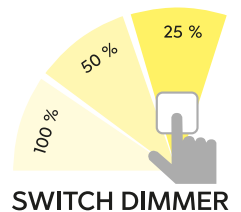

1 Deckenleuchte · Ceiling lamp
 ↔ 65 x 65 cm, ↑ 5 cm
 incl. SMD-LED, 28 W
 3.200 lm, 4.000 K



676240306
 676240331

2 Deckenleuchte · Ceiling lamp
 ↔ 65,5 x 65,5 cm, ↑ 6,5 cm
 incl. SMD-LED, 38 W
 4.400 lm, 4.000 K



676240406
 676240431

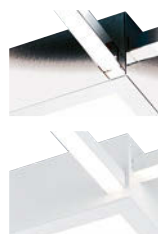

06 | Chrom · chrome

31 | Weiß matt · white mat



2





Empfohlen:
recommended: LED GU10, 3 W
250 lm, 3.000 K



956-30

1 Deckenleuchte · Ceiling lamp

↔ 77,4 x 57,4 cm, ↓ 22,4 cm
excl. 5 x GU10, max. 35 W



612400580

2 Strahler · Spot

↔ 24 x 24 cm, ↓ 15 cm
excl. 4 x GU10, max. 35 W



802430480

3 Strahler · Spot

↔ 30 x 9 cm, ↓ 15 cm
excl. 2 x GU10, max. 35 W



802400280

4 Strahler · Spot

↔ 48 x 9 cm, ↓ 15 cm
excl. 3 x GU10, max. 35 W



802400380

5 Strahler · Spot

↔ 12 x 12 cm, ↓ 15 cm
excl. 1 x GU10, max. 25 W



802400180



MARLEY

Metall, Schwarz-Gold · metal, black-gold

6 Pendelleuchte · Pendant
 ↔ 115 x 18 cm, ↓ 150 cm
 excl. 6 x GU10, max. 35 W



302400680

7 Pendelleuchte · Pendant
 ↔ 80 x 18 cm, ↓ 150 cm
 excl. 4 x GU10, max. 35 W



302400480





MARLEY

Metall · metal

1 Pendelleuchte · Pendant
↔ 80 x 18 cm, ↑ 150 cm
excl. 4 x GU10, max. 35 W



302400404
302400407
302400431
302400432

2 Pendelleuchte · Pendant
↔ 115 x 20 cm, ↑ 150 cm
excl. 6 x GU10, max. 35 W



302400604
302400607
302400631
302400632

Empfohlen:
recommended:



LED GU10, 3 W
250 lm, 3.000 K

956-30



04 | Altmessing · old brass



07 | Nickel matt · nickel mat



31 | Weiß matt · white mat



32 | Schwarz matt · black mat



07 | Nickel matt / Holz -
nickel mat / wood

31 | Weiß matt / Holz -
white matt / wood

32 | Schwarz matt / Holz -
black matt / wood

3 Pendelleuchte · Pendant
↔ 115 x 20 cm, ↓ 150 cm
excl. 6 x GU10, max. 35 W



312490607
312490631
312490632

4 Pendelleuchte · Pendant
↔ 80 x 18 cm, ↓ 150 cm
excl. 4 x GU10, max. 35 W



312490407
312490431
312490432

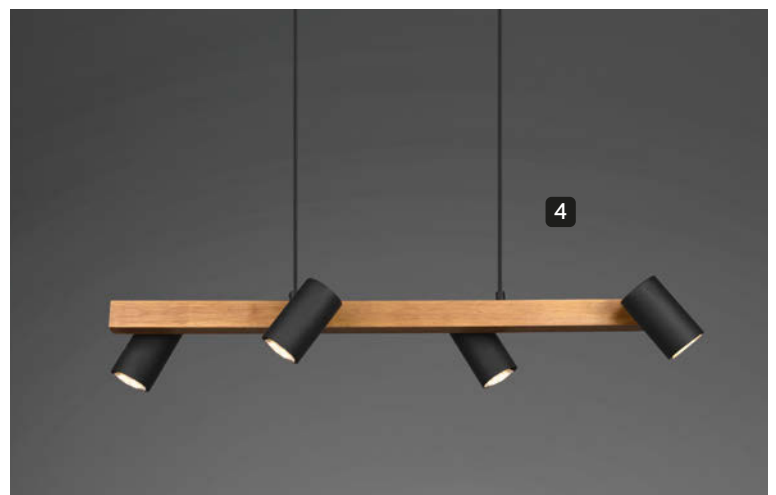

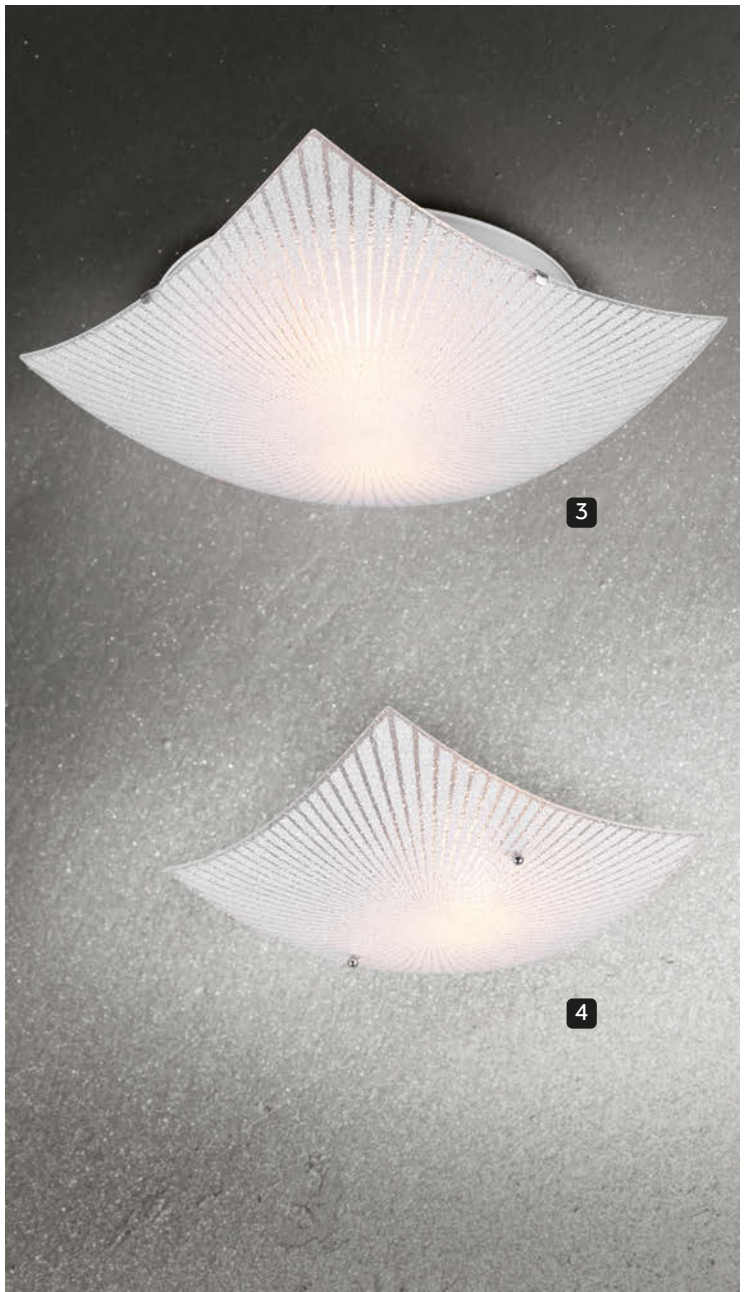

PURA

Metall, Glas · metal, glass



04 | Altmessing · old brass

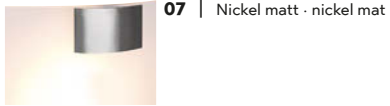

07 | Nickel matt · nickel mat

Empfohlen:
recommended: Filament LED E27, 7 W
806 lm, 2.700 K



987-6810

1 Wandleuchte · Wall lamp
↓ 40 cm, ↔ 20 cm, ↗ 7,5 cm
excl. 2 x E27, max. 25 W



212700204
212700207

2 Wandleuchte · Wall lamp
↓ 20 cm, ↔ 20 cm, ↗ 7,5 cm
excl. 1 x E27, max. 25 W



212700104
212700107

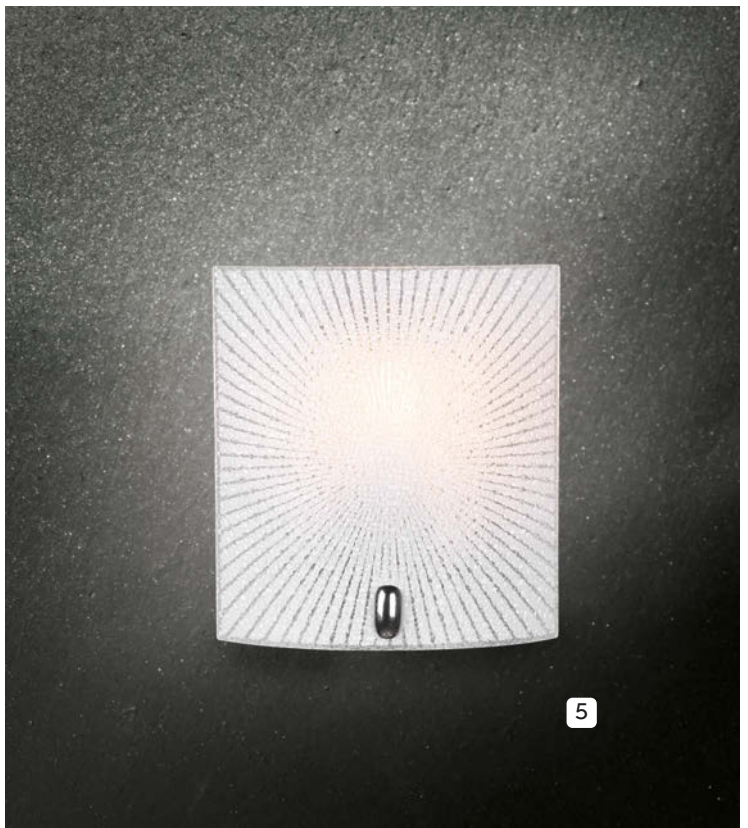

5

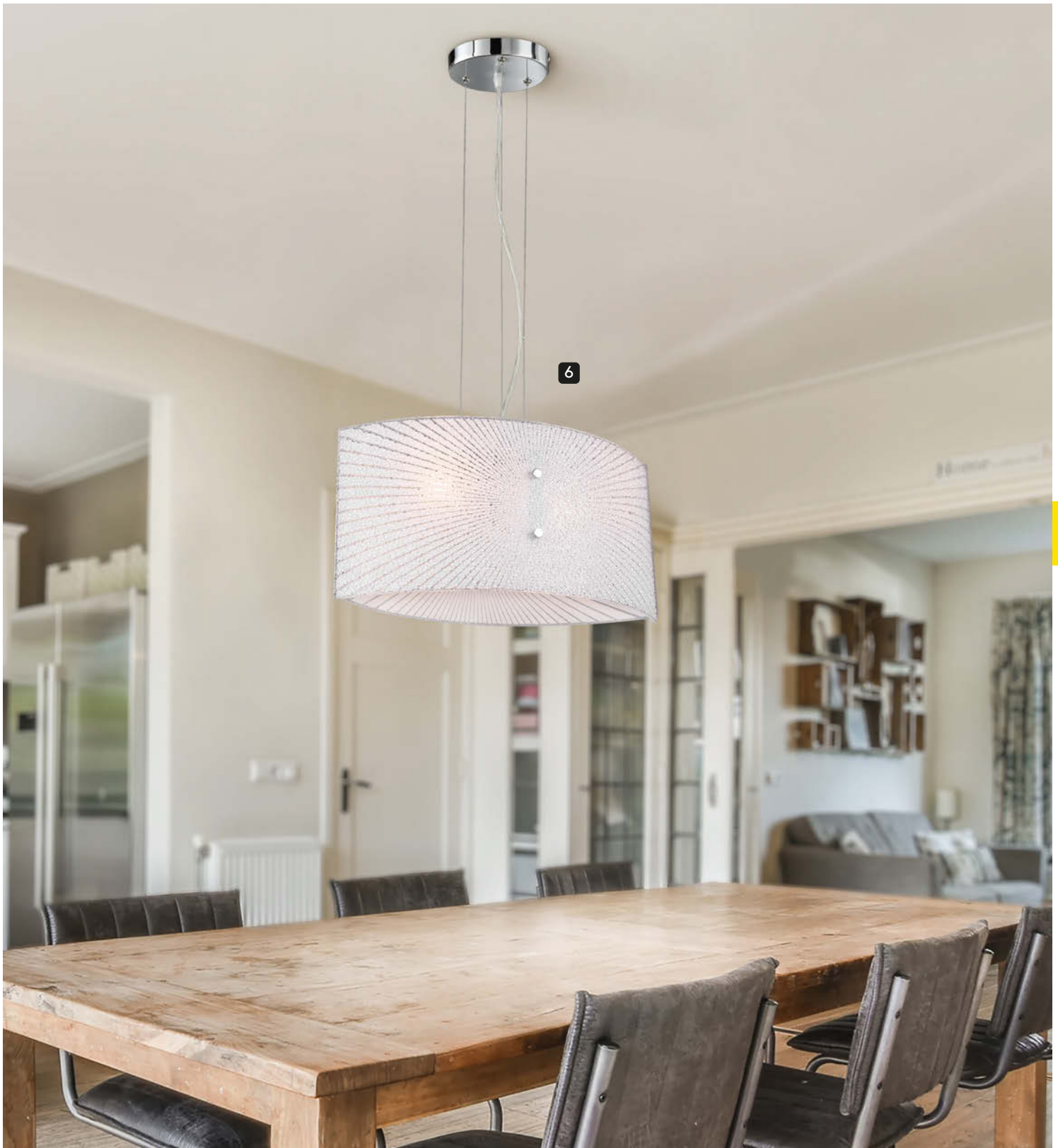

ELISA

Metall, Glas · metal, glass



Empfohlen:
recommended:



Filament LED E27, 4,5 W
470 lm, 2.700 K

987-400

3 Deckenleuchte · Ceiling lamp

↔ 40 x 40 cm, ↓ 9,5 cm
excl. 2 x E27, max. 40 W



612200200

4 Deckenleuchte · Ceiling lamp

↔ 30 x 30 cm, ↓ 9 cm
excl. 1 x E27, max. 40 W



612200100

5 Wandleuchte · Wall lamp

↓ 22 cm, ↔ 20 cm, ↗ 8,5 cm
excl. 1 x E27, max. 40 W



212200100

6 Pendelleuchte · Pendant

↔ 40 x 20 cm, ↓ 150 cm
excl. 2 x E27, max. 40 W



312200200



RUNA

Metall, Schwarz matt, Sisal · metal, black mat, Sisal

- 1** Wandleuchte · Wall lamp
 ↓ 27,5 cm, ↔ 23 cm, ↗ 15 cm
 excl. 1 x E27, max. 40 W



203000132

- 2** Pendelleuchte · Pendant
 Ø 35 cm, ↓ 150 cm
 excl. 1 x E27, max. 40 W



303090132

- 3** Pendelleuchte · Pendant
 Ø 25 cm, ↓ 150 cm
 excl. 1 x E27, max. 40 W



303000132

- 4** Stehleuchte · Floor lamp
 ↓ 150 cm, Ø 35 cm
 excl. 1 x E27, max. 40 W



403000132

Empfohlen:
 recommended: Filament LED E27, 4,5 W
 470 lm, 2.700 K



987-400



2

3

4



PERRY

Metall · metal

Tischleuchte · Table lamp
 † 46 cm, Ø 16 cm, ∅ 28 cm
 excl. 1 x E27, max. 28 W



- 504900104 | Altmessing · old brass
- 504900107 | Nickel matt · nickel mat
- 504900131 | Weiß matt · white mat
- 504900132 | Schwarz matt · black mat

Empfohlen:
 recommended:



LED E27, 6 W
 470 lm, 3.000 K



987-60





MAXI

Metall · metal

-  4 fach TOUCH -
4 level Touch function
-  Akkubetrieb ·
Rechargeablebattery operated
-  USB Anschluss ·
USB connection

Strahler · Spot
 † 36 cm, ↔ 20 cm, ⚬ 12 cm
 incl. SMD-LED, 2 W
 200 lm, 3.000 K



R52121111
 R52121131
 R52121132

MAGNETIC.

MULTI FLEX.



11 | Grau · grey



31 | Weiß matt · white mat



32 | Schwarz matt · black mat



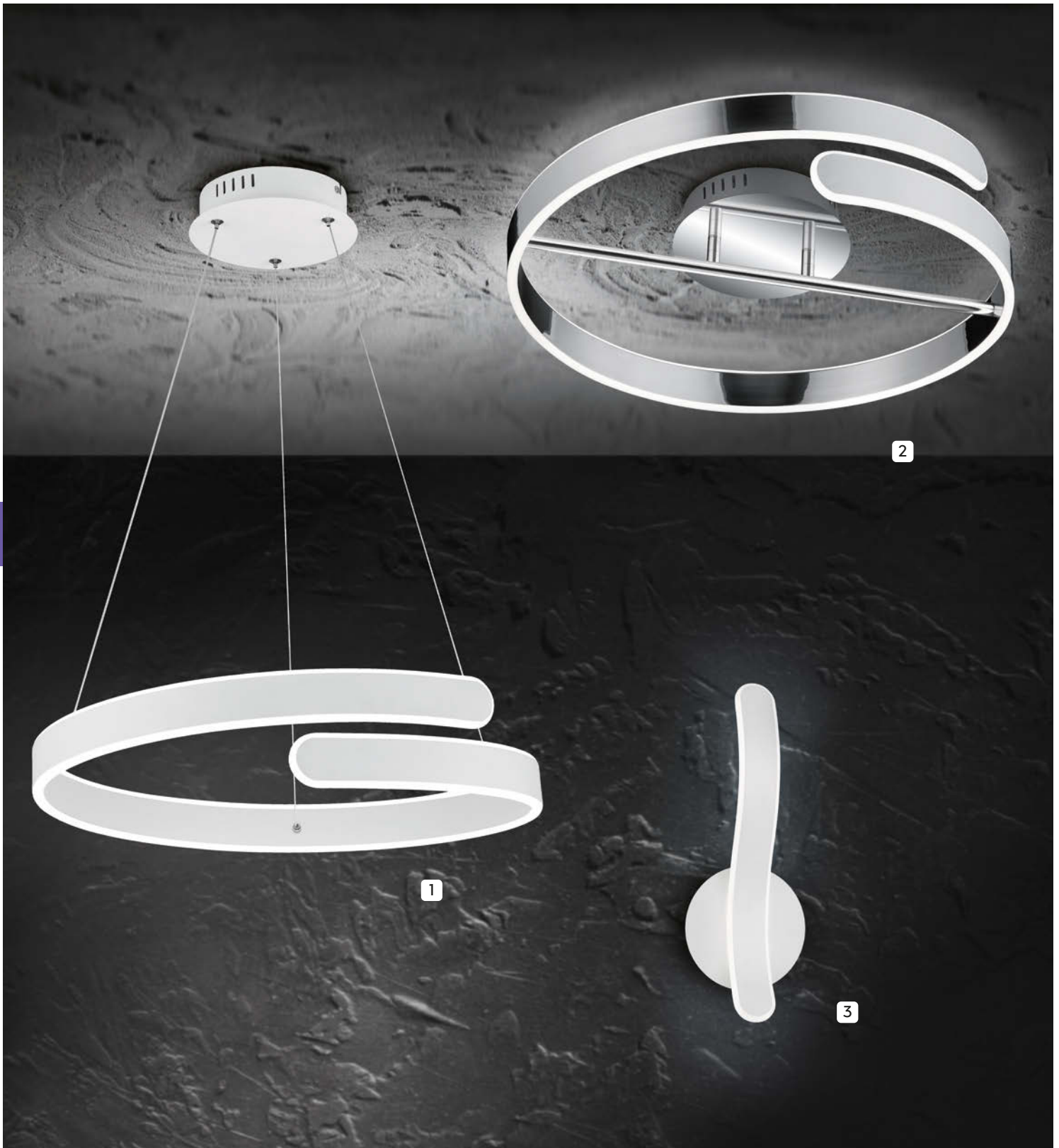

PARMA

Metall, Acryl · metal, acryl



4.000 Kelvin

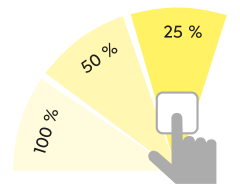

SWITCH DIMMER

1 Pendelleuchte · Pendant

Ø 50 cm, ↑ 150 cm
incl. SMD-LED, 37 W
4.500 lm, 4.000 K



R37071106
R37071131

2 Deckenleuchte · Ceiling lamp

Ø 50 cm, ↓ 13,5 cm
incl. SMD-LED, 37 W
4.500 lm, 4.000 K



R67071106
R67071131

3 Wandleuchte · Wall lamp

↑ 39 cm, ↔ 15 cm, ↗ 9,5 cm
incl. SMD-LED, 11 W
1.400 lm, 4.000 K



R27071106
R27071131



06 | Chrom · chrome



31 | Weiß matt · white mat



1

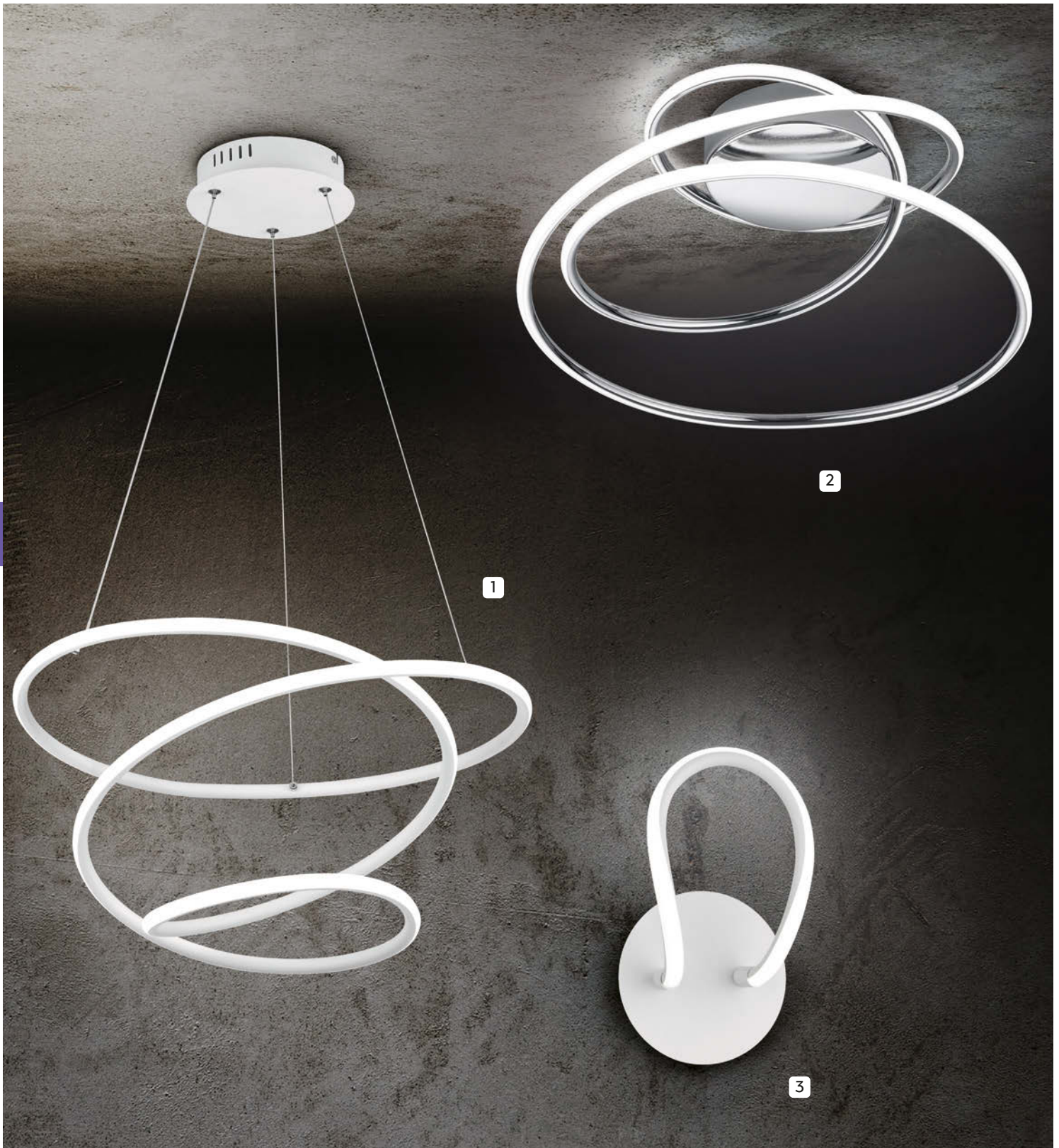

BOLOGNA

Metall, Acryl · metal, acryl

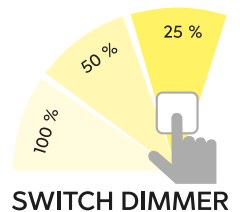

1 Pendelleuchte · Pendant
 Ø 50 cm, ↓ 150 cm
 incl. SMD-LED, 36 W
 5.100 lm, 4.000 K



R37051106
 R37051131

2 Deckenleuchte · Ceiling lamp
 ↔ 50 x 48 cm, ↓ 28 cm
 incl. SMD-LED, 36 W
 5.100 lm, 4.000 K



R67051106
 R67051131

3 Wandleuchte · Wall lamp
 ↓ 26 cm, ↔ 15 cm, ↗ 15 cm
 incl. SMD-LED, 11,5 W
 1.300 lm, 4.000 K



R27051106
 R27051131



06 | Chrom · chrome



31 | Weiß matt · white mat



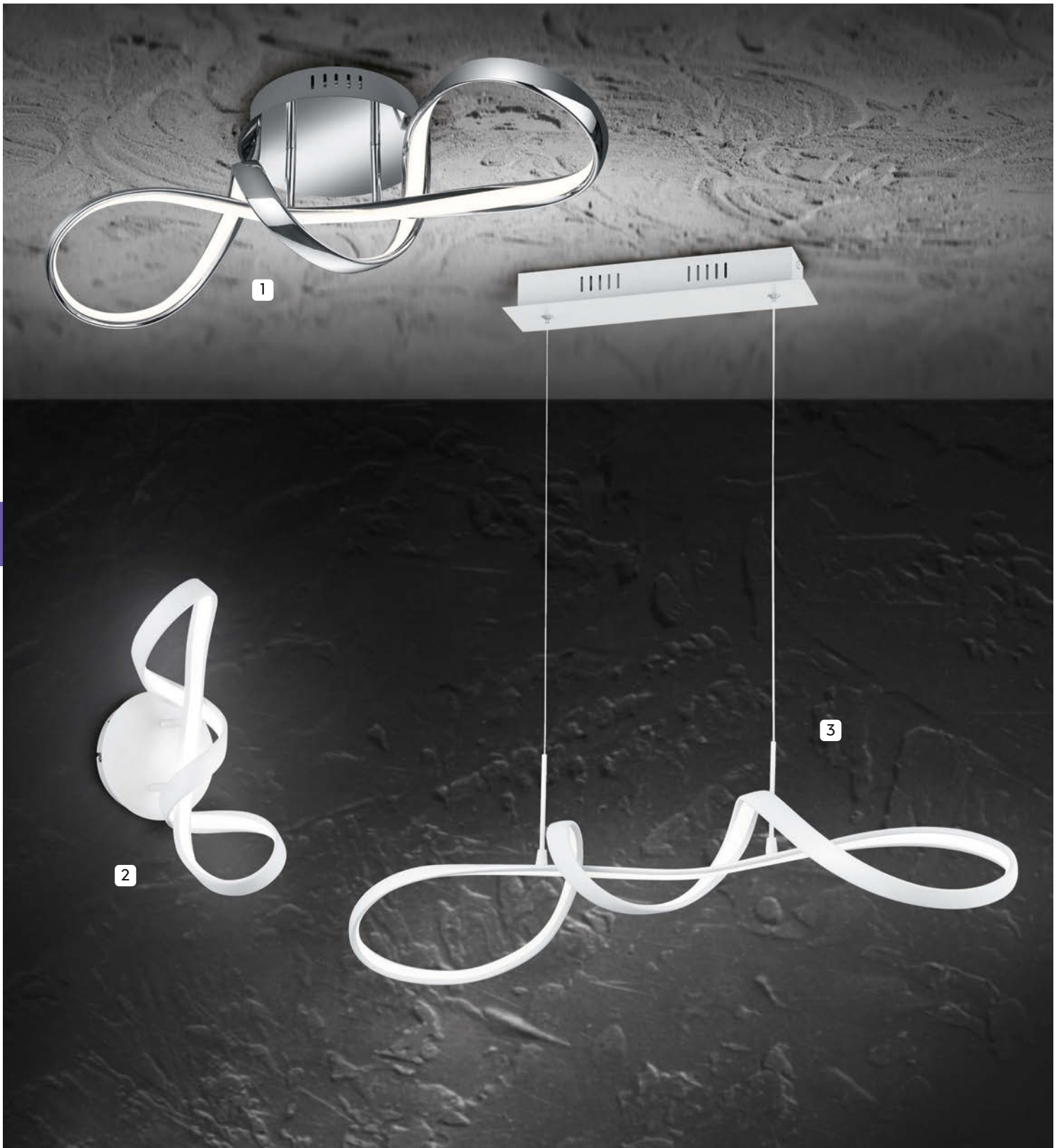

PERUGIA

Metall, Acryl · metal, acryl



4.000 Kelvin

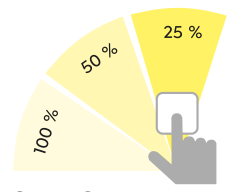

SWITCH DIMMER

1 Deckenleuchte · Ceiling lamp
↔ 60 x 18 cm, ↓ 22 cm
incl. SMD-LED, 28 W
3.400 lm, 4.000 K



R67091106
R67091131

2 Wandleuchte · Wall lamp
↓ 40 cm, ↔ 22 cm, ↗ 17,5 cm
incl. SMD-LED, 18 W
2.400 lm, 4.000 K



R27091106
R27091131

3 Pendelleuchte · Pendant
↔ 81 x 46 cm, ↓ 150 cm
incl. SMD-LED, 37 W
4.500 lm, 4.000 K



R37091106
R37091131



06 | Chrom · chrome



31 | Weiß matt · white mat



3

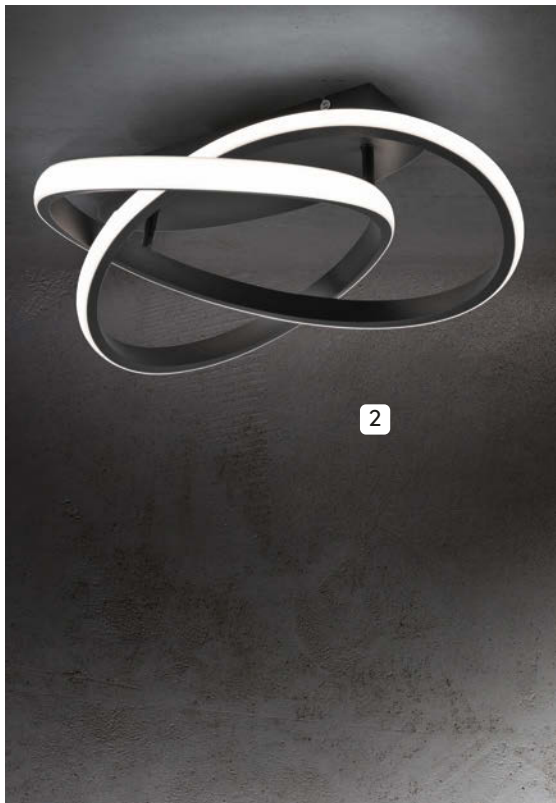
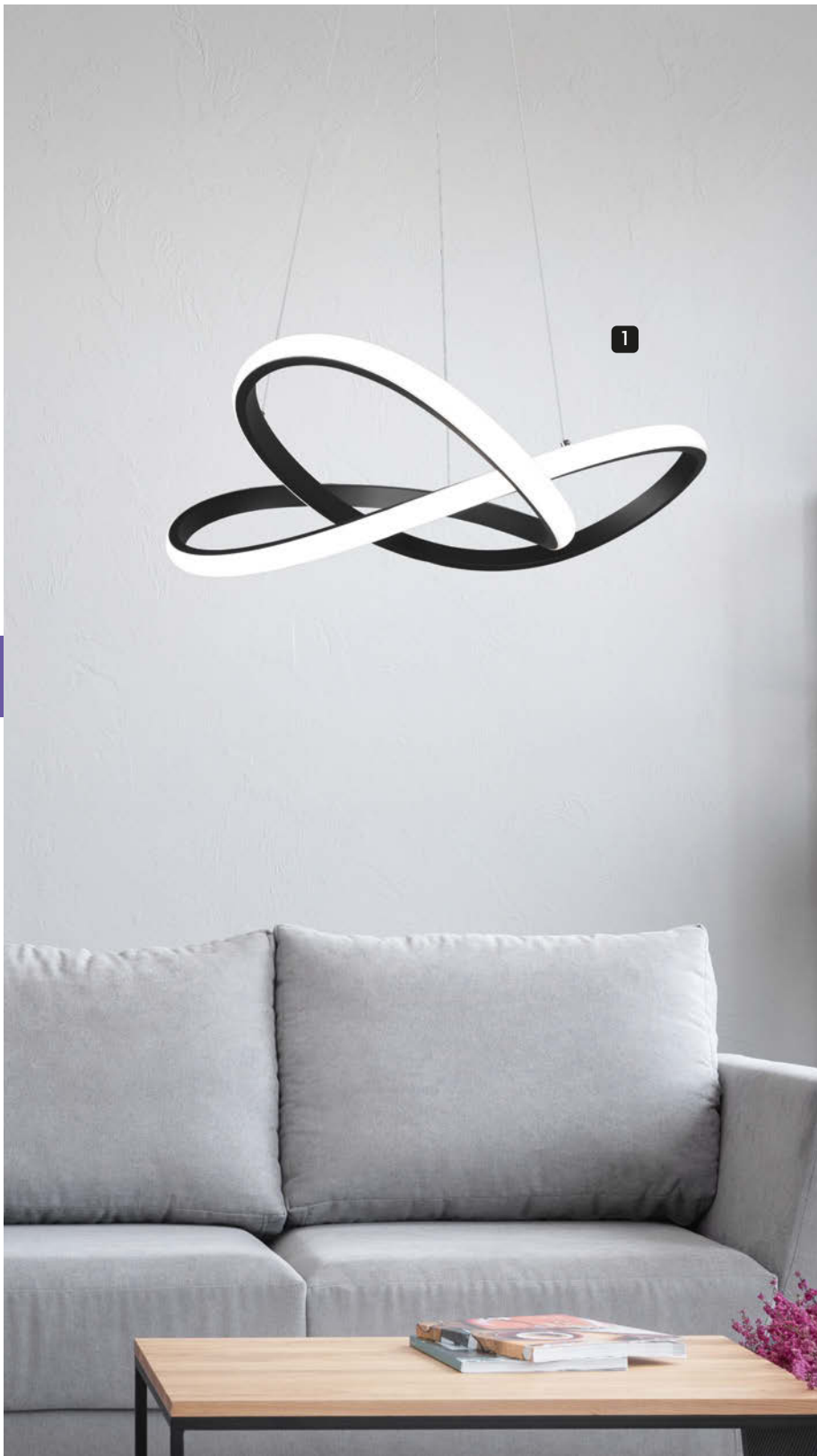

COURSE

Metall, Acryl · metal, acryl

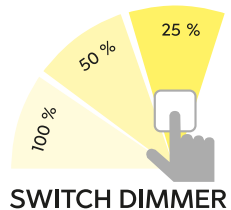

1 Pendelleuchte · Pendant
 Ø 60 cm, ↑ 150 cm
 incl. SMD-LED, 27,5 W
 3.150 lm, 4.000 K



R32051407
 R32051432

2 Deckenleuchte · Ceiling lamp
 Ø 45 cm, ↑ 18,8 cm
 incl. SMD-LED, 18 W
 2.400 lm, 4.000 K



R62051407
 R62051432



07 | Nickel matt · nickel mat



32 | Schwarz matt · black mat



VENIDA

Metall, Acryl · metal, acryl

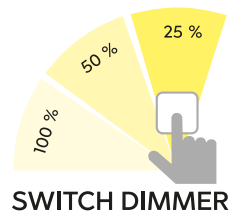

1 Deckenleuchte · Ceiling lamp
 ↔ 50 x 30 cm, ↑ 7,5 cm
 incl. SMD-LED, 25 W
 3.000 lm, 4.000 K



R62783406
 R62783431

2 Deckenleuchte · Ceiling lamp
 ↔ 57,5 x 35,5 cm, ↑ 7,5 cm
 incl. SMD-LED, 25 W
 3.000 lm, 4.000 K



R62793406
 R62793431



PIVOT

Metall, Acryl · metal, acryl



Deckenleuchte · Ceiling lamp
 ↔ max. 42 x 54,5 cm, 17,7 cm
 incl. SMD-LED, 23,5 W
 3.000 lm, 4.000 K



R62162405
 R62162432
 R62162499

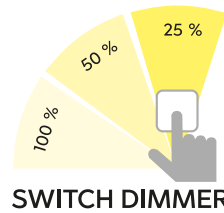
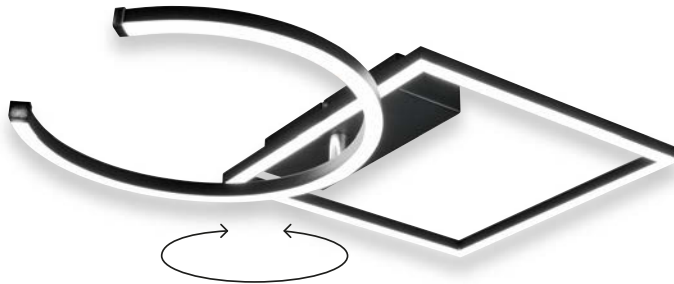

05 | Aluminium gebürstet ·
 brushed aluminium



32 | Schwarz matt · black mat

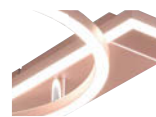

99 | Roségold · rose gold



PADELLA

Metall, Acryl · metal, acryl



Deckenleuchte · Ceiling lamp
 ↔ max. 63 x 37 cm, ↓ 7,5 cm
 incl. SMD-LED, 25 W
 3.000 lm, 4.000 K



R62642407
 R62642432
 R62642499

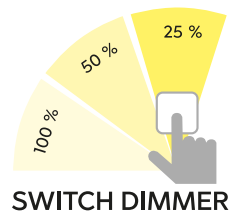
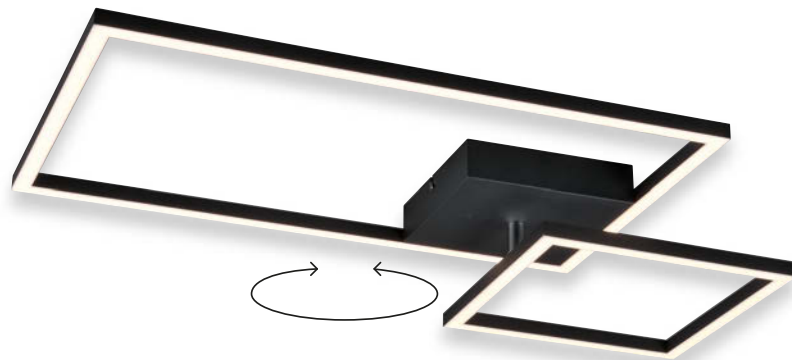

07 | Nickel matt · nickel mat

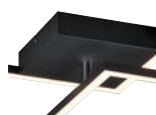

32 | Schwarz matt · black mat

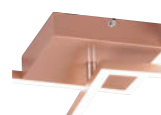

99 | Roségold · rose gold

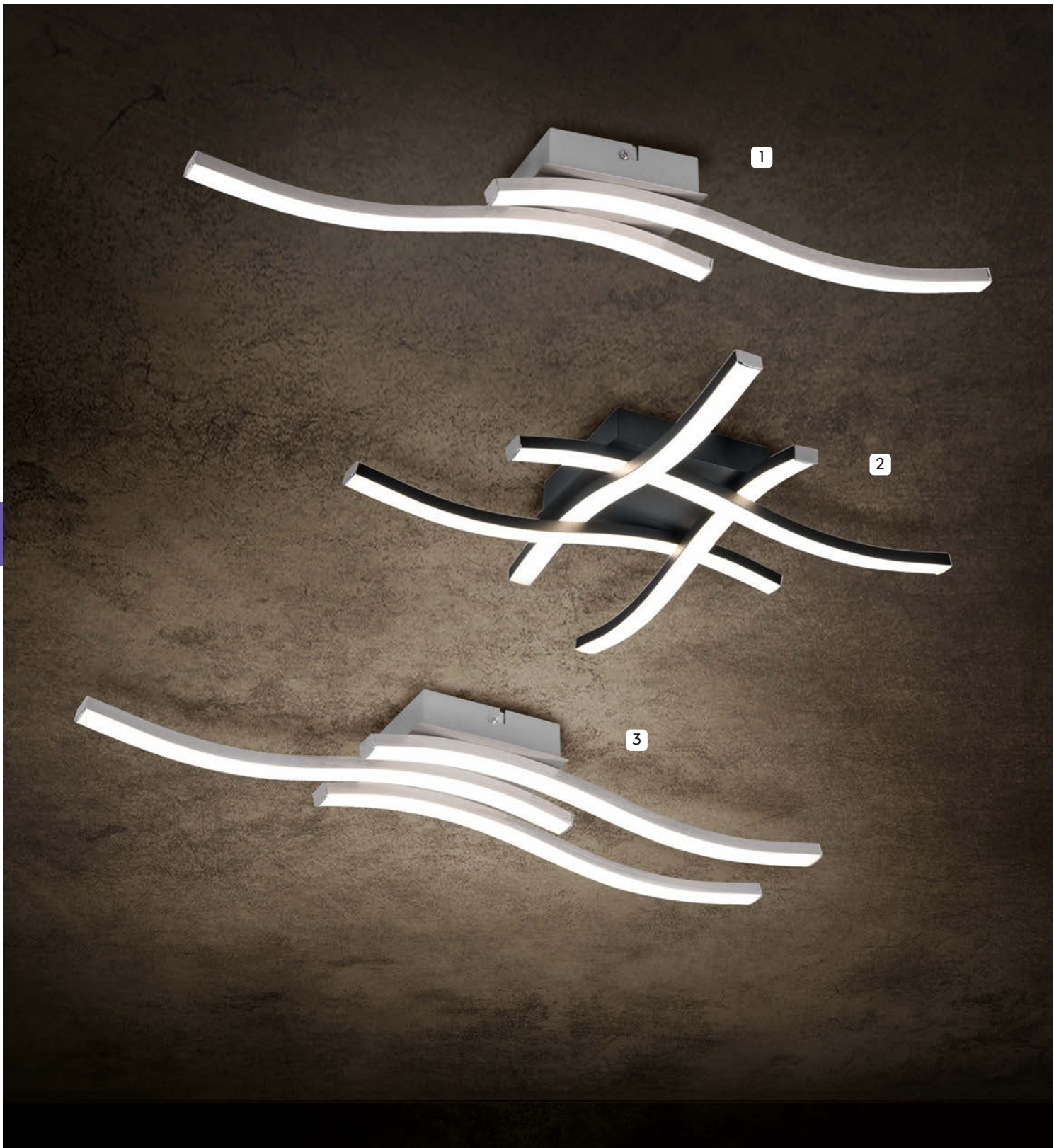

ROUTE

Metall, Acryl · metal, acryl



1 Deckenleuchte · Ceiling lamp
 ↔ 56 x 9 cm, ↓ 7 cm
 incl. 2 x SMD-LED, 5 W
 2 x 600 lm, 4.000 K



R62472407
 R62472432

2 Deckenleuchte · Ceiling lamp
 ↔ 46 x 46 cm, ↓ 7 cm
 incl. 4 x SMD-LED, 5 W
 4 x 600 lm, 4.000 K



R62474407
 R62474432

3 Deckenleuchte · Ceiling lamp
 ↔ 56 x 12 cm, ↓ 7 cm
 incl. 3 x SMD-LED, 5 W
 3 x 600 lm, 4.000 K



R62473407
 R62473432

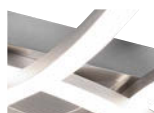

07 | Nickel matt · nickel mat



32 | Schwarz matt · black mat

NEW COLOUR

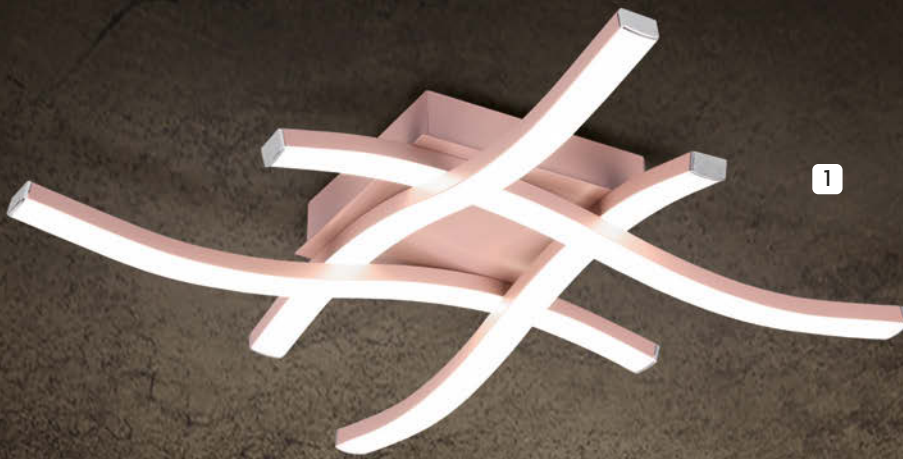

1



2



3

ROUTE

Metall, Roségold, Acryl · metal, rose gold, acryl



4.000 Kelvin



99 | Roségold · rose gold

1 Deckenleuchte · Ceiling lamp

↔ 46 x 46 cm, ↑ 7 cm
incl. 4 x SMD-LED, 5 W
4 x 600 lm, 4.000 K



R62474499

2 Deckenleuchte · Ceiling lamp

↔ 56 x 12 cm, ↑ 7 cm
incl. 3 x SMD-LED, 5 W
3 x 600 lm, 4.000 K



R62473499

3 Deckenleuchte · Ceiling lamp

↔ 56 x 9 cm, ↑ 7 cm
incl. 2 x SMD-LED, 5 W
2 x 600 lm, 4.000 K





R62472499



BORGHOLM

Metall, Kunststoff · metal, plastic

 Lichtfarbe stufenlos einstellbar ·
Light color infinitely variable

 Integrierter Dimmer ·
Integrated dimmer

Ventilator · Fan
Ø 50 cm, ↑ 14 cm
incl. SMD-LED, 30 W
3.000 lm, 2.700 - 6.000 K



R67083131 | Weiß matt · white mat
R67083132 | Schwarz matt · black mat



2.700 K

6.000 K



ALESUND

Metall, Kunststoff · metal, plastic

 Lichtfarbe einstellbar · Adjustable light color

 Getrennt schaltbar · Separately switchable

Ventilator · Fan

Ø 143 cm, ↑ 50 cm
incl. SMD-LED, 20 W
2.000 lm, 2.700 + 4.000 + 6.000 K



- R67142131 | Weiß matt · white mat
- R67142132 | Schwarz matt · black mat
- R67142187 | titanfarbig · titan



2.700 K

4.000 K

6.000 K



TRONDHEIM

Metall, Kunststoff · metal, plastic

 3 Geschwindigkeitsstufen · 3 modes of speed

 Timer · Timer

Ventilator · Fan
Ø 48 cm, 18 cm
excl. 4 x E27, max. 40 W



R61095031
R61095032
R61105032



Empfohlen:
recommended: Filament LED E27, 4,5 W
470 lm, 2.700 K



987-400



31 | Weiß matt · white mat



32 | Schwarz matt · black mat

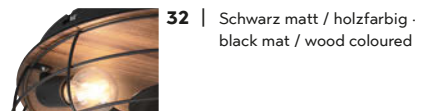

32 | Schwarz matt / holzfarbig · black mat / wood coloured





32

JUDY

Messing matt, Samt · brass mat, velvet

Empfohlen:
recommended: Filament LED E27, 6 W
420 lm, 2.700 K



988-679



02 | Schwarz · black



10 | Rot · red



11 | Grau · grey



12 | Blau · blue



15 | Grün · green

1 Tischleuchte · Table lamp

↑ 11 cm, Ø 11 cm
excl. 1 x E27, max. 40 W



R50691002
R50691010
R50691011
R50691012
R50691015



SOPHIA

Keramik, goldfarbig, Samt · ceramic, gold, velvet

Empfohlen:
recommended: Filament LED E14, 4,5 W
470 lm, 2.700 K



989-400



02 | Schwarz · black



10 | Rot · red



11 | Grau · grey



12 | Blau · blue



15 | Grün · green

2 Tischleuchte · Table lamp

↑ 26 cm, Ø 16 cm
excl. 1 x E14, max. 40 W



R50821002
R50821010
R50821011
R50821012
R50821015



ALBERT

Keramik, Stoff · ceramic, fabric

80 | goldfarbig,
Schirm Schwarz-Gold ·
gold, fabric black-gold

88 | Silber antik,
Schirm Weiß-Silber ·
antique silver, fabric white-silver

1 Tischleuchte · Table lamp

↑ 36 cm, Ø 21 cm
excl. 1 x E14, max. 40 W



R50311080
R50311088

Empfohlen:
recommended: Filament LED E14, 4,5 W
470 lm, 2.700 K



989-400



JERRY

Metall, Stoff · metal, fabric

01 | Weiß · white

11 | Grau · grey

80 | Schwarz-Gold · black gold

2 Tischleuchte · Table lamp

↑ 28,5 cm, Ø 13 cm
excl. 1 x E14, max. 40 W



R50491001
R50491011
R50491080

LUCI

Holznachbildung, Stoff · wood imitate, fabric

Empfohlen:
recommended: Filament LED E14, 4,5 W
470 lm, 2.700 K



989-400

1 Tischleuchte · Table lamp
↓ 23 cm, Ø 14 cm
excl. 1 x E14, max. 40 W



R50351035

34



1

LUXOR

Holznachbildung, Stoff · wood imitate, fabric

Empfohlen:
recommended: Filament LED E14, 4,5 W
470 lm, 2.700 K



989-400

Empfohlen:
recommended: Filament LED E27, 4,5 W
470 lm, 2.700 K



987-400

2 Tischleuchte · Table lamp
↓ 35 cm, Ø 24 cm
excl. 1 x E27, max. 60 W



R50631035

3 Tischleuchte · Table lamp
↓ 26 cm, Ø 18 cm
excl. 1 x E14, max. 40 W



R50621035



2

3



WOODY

Naturholz, Stoff · natural wood, fabric

Empfohlen:
recommended:

Filament LED E14, 4,5 W
470 lm, 2.700 K



989-400

Empfohlen:
recommended:

Filament LED E27, 4,5 W
470 lm, 2.700 K



987-400

1 Tischleuchte · Table lamp
↑ 30 cm, ↔ 12 x 12 cm
excl. 1 x E14, max. 40 W



R50171030
R50171080

2 Tischleuchte · Table lamp
↑ 30 cm, Ø 12 cm
excl. 1 x E14, max. 40 W



R50171930
R50171980

3 Tischleuchte · Table lamp
↑ 30,5 cm, ↔ 30 x 12 cm
excl. 1 x E27, max. 60 W



R50181030
R50181080

30 | Weiß · white



80 | Schwarz-Gold · black-gold





1



2

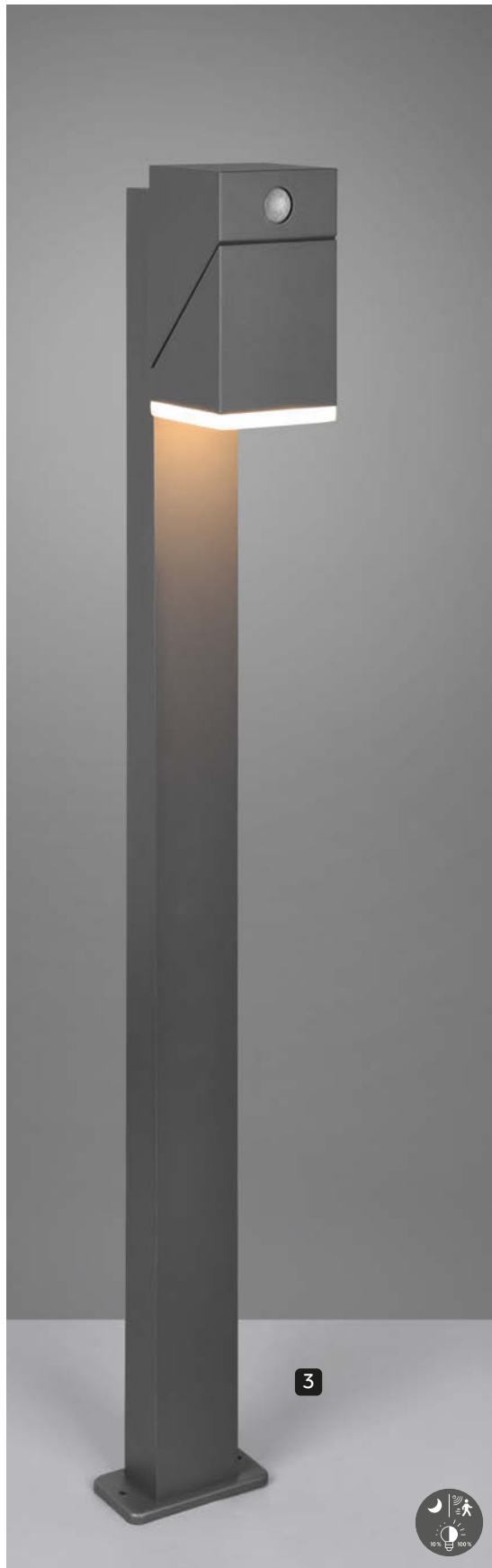

3



AVON

Aluminium Druckguss, Anthrazit - diecast aluminium, anthracite

1 Wandleuchte - Wall lamp

↑ 16 cm, ↔ 9 cm, ∠ 12 cm
incl. SMD-LED, 6 W
600 lm, 3.000 K



270669142

2 Pollerleuchte - Pole lamp

↑ 50 cm, ↔ 12 cm, ∠ 18 cm
incl. SMD-LED, 6 W
600 lm, 3.000 K



570669142

3 Pollerleuchte - Pole lamp

↑ 100 cm, ↔ 12 cm, ∠ 18 cm
incl. SMD-LED, 6 W
600 lm, 3.000 K



470669142

4 Wandleuchte - Wall lamp

↑ 28 cm, ↔ 9 cm, ∠ 12 cm
incl. 2 x SMD-LED, 6 W
2 x 600 lm, 3.000 K



270669242

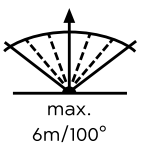

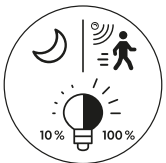

Die Leuchten verfügen über ein permanentes Orientierungslicht, das bei Dämmerung oder Dunkelheit automatisch mit einer Helligkeit von ca. 10% leuchtet. Bei Bewegungen im näheren Umfeld, schaltet das Licht auf 100%. Leuchtdauer und Sensitivität einstellbar.

The luminaire has a permanent orientation light that automatically illuminates at a brightness of approx. 10% at dusk or darkness. The light switches to 100% in case of movement in the immediate vicinity. Light duration and sensitivity adjustable.



1

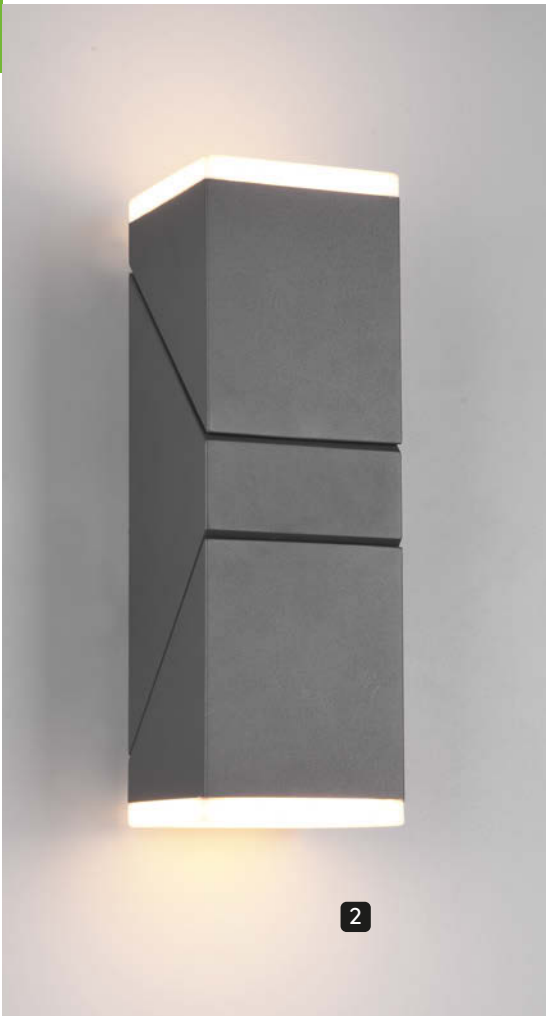

2



3



AVON

Aluminium Druckguss, Anthrazit · diecast aluminium, anthracite

1 Wandleuchte · Wall lamp
 † 16 cm, ↔ 9 cm, √ 10,5 cm
 incl. SMD-LED, 6 W
 600 lm, 3.000 K



270660142

2 Wandleuchte · Wall lamp
 † 28 cm, ↔ 9 cm, √ 10,5 cm
 incl. 2 x SMD-LED, 6 W
 2 x 600 lm, 3.000 K



270660242

3 Pollerleuchte · Pole lamp
 † 50 cm, ↔ 12 cm, √ 16,5 cm
 incl. SMD-LED, 6 W
 600 lm, 3.000 K



570660142

4 Pollerleuchte · Pole lamp
 † 100 cm, ↔ 12 cm, √ 16,5 cm
 incl. SMD-LED, 6 W
 600 lm, 3.000 K



470660142

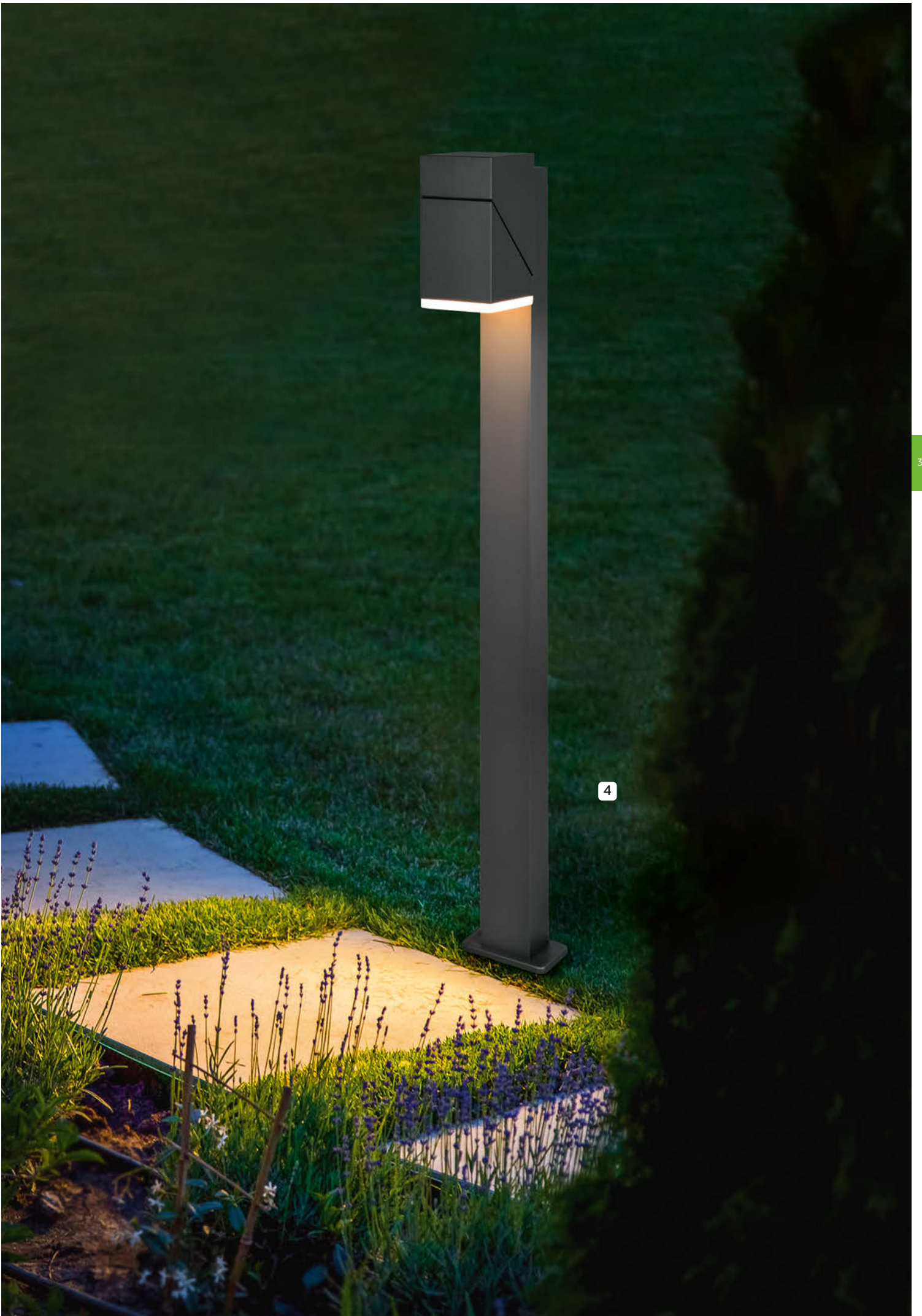

4

CAVADO

Aluminium Druckguss, Glas ·
diecast aluminium, glass

1 Wandleuchte · Wall lamp

↑ 28 cm, ↔ 16 cm, ↗ 23 cm
excl. 1 x E27, max. 40 W



211060131
211060142

2 Wandleuchte · Wall lamp

↑ 28 cm, ↔ 16 cm, ↗ 23 cm
excl. 1 x E27, max. 40 W



211069131
211069142

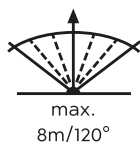

Empfohlen:
recommended: Filament LED E27, 4,5 W
470 lm, 2.700 K



987-400



40

MERSEY

Aluminium Druckguss, Anthrazit, Glas ·
diecast aluminium, anthracite, glass

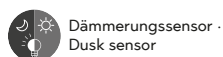

Dämmerungssensor ·
Dusk sensor



Empfohlen:
recommended: LED E14, 4 W
320 lm, 3.000 K



983-40

3 Wandleuchte · Wall lamp

↑ 27,5 cm, ↔ 18 cm, ↗ 11 cm
excl. 2 x E14, max. 40 W



212160242

incl.
0 - 9
A - Z





WITHAM

Aluminium Druckguss, Anthrazit · diecast aluminium, anthracite



DIP SWITCH

Lichtfarben direkt an der Leuchte einstellbar · Colours directly adjustable at the lamp · Les couleurs de la lumière peuvent être réglées directement sur le luminaire · Lichtkleuren direct instelbaar op de lamp · Tonalidades de luz ajustables directamente en la lámpara · Colori della luce regolabili direttamente sulla lampada · Culori ale luminii reglabile direct de la bec · Valon väri asetettävissa suoraan valaisimesta · Barwy światła można ustawić bezpośrednio na oprawie

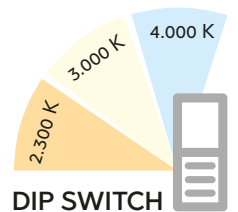

DIP SWITCH

1 Deckenleuchte · Ceiling lamp
 ↔ 30 x 30 cm, ↓ 10 cm
 incl. SMD-LED, 14 W
 1.550 lm, 2.300 + 3.000 + 4.000 K



677860142

2 Wandleuchte · Wall lamp
 ↓ 24 cm, ↔ 18 cm, ↗ 10 cm
 incl. SMD-LED, 10,5 W
 1.100 lm, 2.300 + 3.000 + 4.000 K



277860142



2.300 K



3.000 K



4.000 K



1



2



3

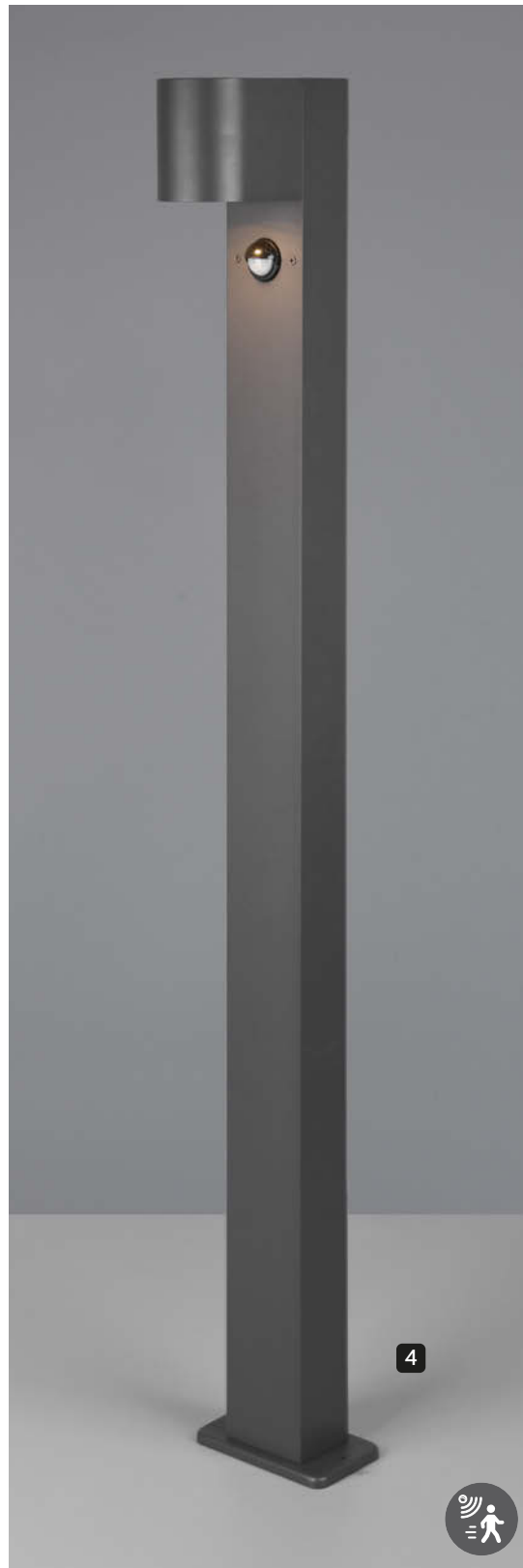

4



ROYA

Aluminium Druckguss, Anthrazit - diecast aluminium, anthracite

Bewegungsmelder - Motion sensor

1 Wandleuchte · Wall lamp
 ↓ 15 cm, ↔ 7 cm, ↗ 12 cm
 excl. 1 x GU10, max. 35 W



214260142

2 Wandleuchte · Wall lamp
 ↓ 22 cm, ↔ 7 cm, ↗ 12 cm
 excl. 2 x GU10, max. 35 W



214260242

3 Pollerleuchte · Pole lamp
 ↓ 50 cm, ↔ 12 cm, ↗ 15 cm
 excl. 1 x GU10, max. 35 W



514260142

4 Pollerleuchte · Pole lamp
 ↓ 100 cm, ↔ 12 cm, ↗ 15 cm
 excl. 1 x GU10, max. 35 W



414260142

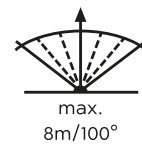



Empfohlen:
recommended:

LED GU10, 5 W
400 lm, 3.000 K



955-50

5 Wandleuchte · Wall lamp

↓ 22 cm, ↔ 7 cm, ↗ 12 cm
excl. 2 x GU10, max. 35 W



214269242

6 Wandleuchte · Wall lamp

↓ 15 cm, ↔ 7 cm, ↗ 12 cm
excl. 1 x GU10, max. 35 W



214269142



ROYA

Aluminium Druckguss · diecast aluminium

1 Wandleuchte · Wall lamp
‡ 15 cm, ↔ 6,9 cm, ⤴ 9,2 cm
excl. 2 x GU10, max. 35 W



204260224
204260231
204260242

2 Wandleuchte · Wall lamp
‡ 15 cm, ↔ 6,9 cm, ⤴ 9,2 cm
excl. 2 x GU10, max. 35 W



204269224
204269231
204269242

3 Pollerleuchte · Pole lamp
‡ 50 cm, ↔ 12 cm, ⤴ 15 cm
excl. 1 x GU10, max. 20 W



504260142

4 Pollerleuchte · Pole lamp
‡ 100 cm, ↔ 12 cm, ⤴ 15 cm
excl. 1 x GU10, max. 20 W



404260142

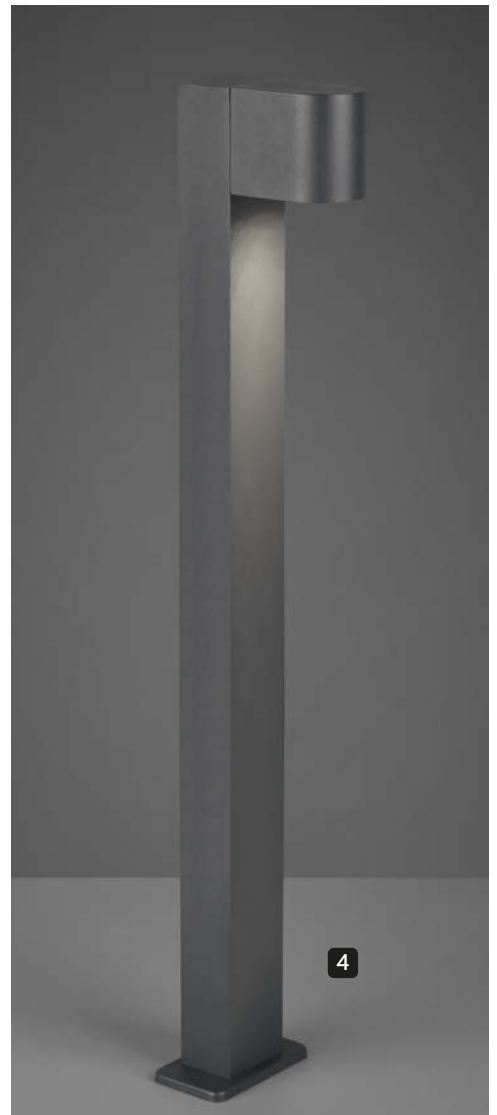



Empfohlen:
recommended:

LED GU10, 5 W
400 lm, 3.000 K



955-50



24 | rostfarbig · rusty



31 | Weiß matt · white mat



42 | Anthrazit · anthracite



LUNGA

Aluminium Druckguss, Anthrazit, Glas · diecast aluminium, anthracite, glass

 Dämmerungssensor ·
Dusk sensor

1 Wandleuchte · Wall lamp
↓ 33,5 cm, ↔ 16 cm, √ 20,5 cm
excl. 1 x E27, max. 40 W



212060142

2 Pollerleuchte · Pole lamp
↓ 60 cm, ↔ 26 cm, √ 16 cm
excl. 1 x E27, max. 40 W



512060142

3 Pollerleuchte · Pole lamp
↓ 100 cm, ↔ 26 cm, √ 16 cm
excl. 1 x E27, max. 40 W



412060142

Empfohlen:
recommended: Filament LED E27, 4,5 W
470 lm, 2.700 K



987-400



4

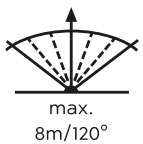

4 Wandleuchte · Wall lamp
 ↓ 33,5 cm, ↔ 16 cm, ↗ 20,5 cm
 excl. 1 x E27, max. 40 W



212069142



1



1



2

TUELA

Aluminium Druckguss, Glas · diecast aluminium, glass

- 1** Wandleuchte · Wall lamp
 † 28 cm, ↔ 16,5 cm, ∇ 23,5 cm
 excl. 1 x E27, max. 40 W



210860124
 210860142

- 2** Pollerleuchte · Pole lamp
 † 100 cm, ↔ 16,5 cm, ∇ 25 cm
 excl. 1 x E27, max. 40 W



410860124
 410860142



24 | rostfarbig · rusty



42 | Anthrazit · anthracite

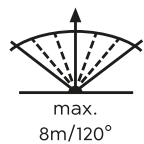

Empfohlen:
recommended: Filament LED E27, 4,5 W
470 lm, 2.700 K



987-400

3 Wandleuchte · Wall lamp
 † 28 cm, ↔ 16,5 cm, √ 23,5 cm
 excl. 1 x E27, max. 40 W



210869124
210869142

LAREDO

Aluminium Druckguss, Anthrazit ·
diecast aluminium, anthracite

1 Wandleuchte · Wall lamp

‡ 21 cm, ↔ 7 cm, ↗ 11 cm
excl. 2 x GU10, max. 10 W



R20026942

2 Wandleuchte · Wall lamp

‡ 16 cm, ↔ 7 cm, ↗ 11 cm
excl. 2 x GU10, max. 10 W



R20026242



2

Empfohlen:
recommended: LED GU10, 5 W
400 lm, 3.000 K



955-50



1



Dämmerungssensor ·
Dusk sensor

PUNO

Kunststoff, Schwarz matt · plastic, black mat

3 Wandleuchte · Wall lamp

Ø 15 cm, ↗ 10 cm
incl. SMD-LED, 8 W
800 lm, 3.000 K

IP54

R27036132

4 Wandleuchte · Wall lamp

‡ 15 cm, ↔ 15 cm, ↗ 10 cm
incl. SMD-LED, 8 W
800 lm, 3.000 K

IP54

R27026132

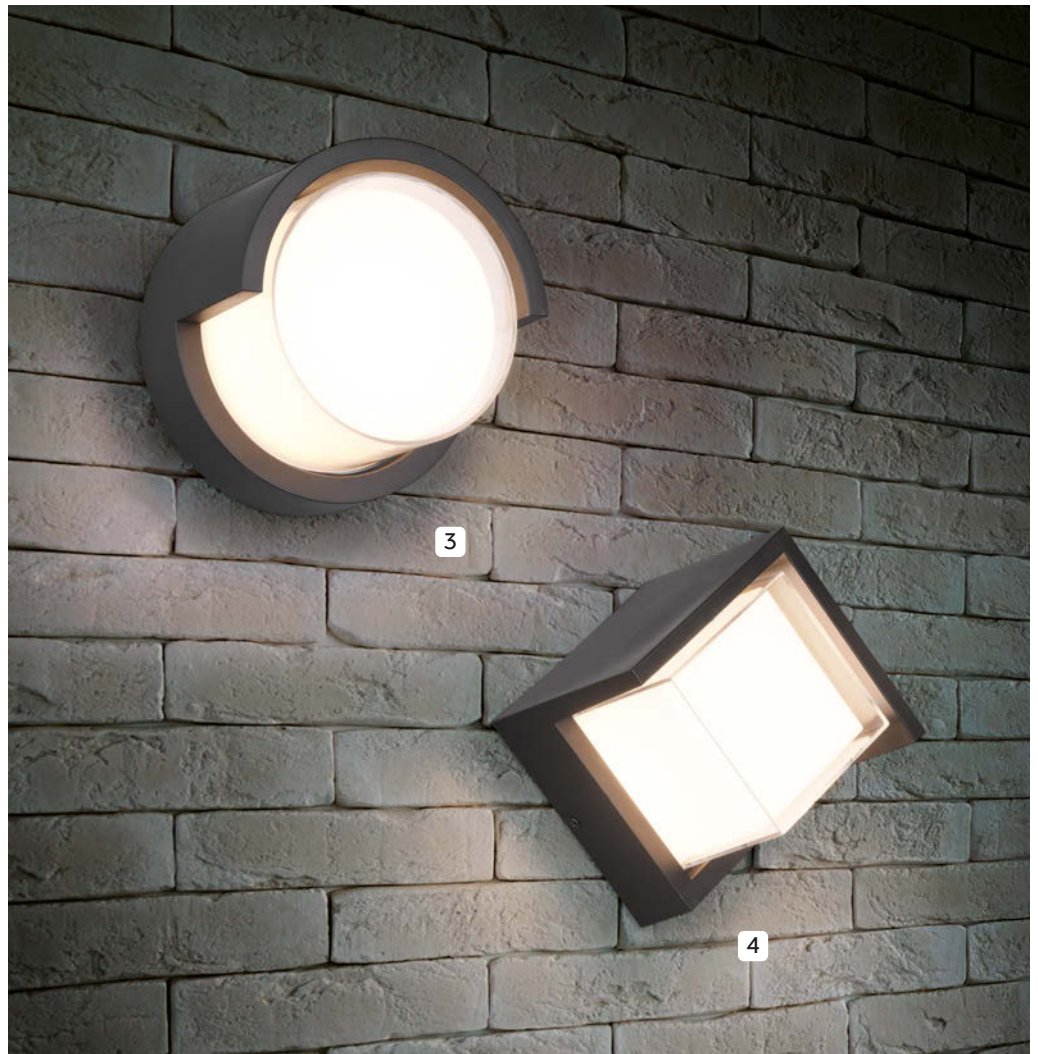

3

4



ROCA

Metall, Schwarz matt, Kunststoff ·
metal, black mat, plastic



 Ladezeit ·
Charging time

 Leuchtdauer ·
Luminous period

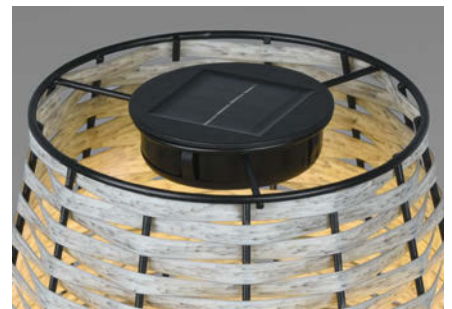

1 Tischleuchte · Table lamp

↓ 32 cm, Ø 19 cm
incl. SMD-LED, 0,12 W



R55356132

2 Stehleuchte · Floor lamp

↓ 140 cm, Ø 25 cm
incl. SMS-LED, 0,15 W



R45356132

MAIRANA

Metall, Schwarz matt · metal, black mat



 Ladezeit ·
Charging time

 Leuchtdauer ·
Luminous period

Tischleuchte · Table lamp
‡ 43,5 cm, Ø 15,5 cm
incl. SMD-LED, 0,1 W



R55306132



SANTANA

Kunststoff, Schwarz matt / Braun ·
plastic, black mat / brown



 Ladezeit ·
Charging time

 Leuchtdauer ·
Luminous period



Tischleuchte · Table lamp
‡ 28 cm, ↔ 18 x 18 cm
incl. SMD-LED, 0,1 W



R55346132





CAMPUS

Metall, Schwarz matt, Kunststoff · metal, black mat, Plastic



 Ladezeit · Charging time

 Leuchtdauer · Luminous period



53

Solarleuchte · Solar lamp
 † 16 cm, Ø 7 cm
 incl. 3 x SMD-LED, 0,1 W



R35146132



CAMARGO

Kunststoff, Schwarz matt · plastic, black mat



Tischleuchte · Table lamp
 † 20 cm, Ø 12,5 cm
 incl. SMD-LED, 0,1 W



R55336132

Farben & Materialien

Colours and materials · Couleurs et matériaux · Kleuren en materialen · Colores y materiales · Colori e materiali · Culori si materiale · Värit ja materiaalit · Kolory i materiały

- 00** Transparent · transparent
transparent · transparant · transparente · transparente · transparent · kirkas · przezroczysty · şeffaf
- 01** Weiß · white
blanc · wit · blanco · bianco · alb · valkoinen · biały
- 02** Schwarz · black
noir · zwart · negro · nero · negru · musta · czarny
- 04** Altmessing · old brass
laiton fumé · oud brons · bronce viejo · ottone invecchiato · bronz antic · antiikkimessinki · patyna
- 05** Aluminium gebürstet · brushed aluminium
aluminium balayé · geborsteld aluminium · aluminio pulido · alluminio spazzolato · aluminiu lucios · harjattu alumiini · aluminium szczotkowane
- 06** Chrom · chrome
chrome · chrom · cromo · cromo · crom · kromi · chrom · krom
- 07** Nickel matt · nickel mat
nickel mat · nikkel mat · níquel mate · nichel opaco · nichel mat · harjattu teräs · nikiel mat
- 08** Messing matt · brass mat
laiton mat · messing mat · bronce mate · ottone satinato · bronz mat · mattamessinki · mosiądz mat
- 10** Rot · red
rouge · rood · rojo · rosso · rosu · punainen · czerwony · kırmızı
- 11** Grau · grey
gris · grijs · gris · grigio · gri · harmaa · popielaty · gri
- 12** Blau · blue
bleu · blauw · azul · azzurro · gri · sininen · niebieski · mavi
- 15** Grün · green
vert · groen · verde · verde · verde · vihreä · zielony
- 24** rostfarbig · rusty
rouille · roestkleur · óxido · ruggine · ruginiu · rustiikki · miedź · pas
- 30** holzfarbig · wood coloured
couleur bois · houtkleur · color madera · colore di legno · culoare lemn · puunvärinen · kolor drewna
- 31** Weiß matt · white mat
blanc mat · wit mat · estera blanca · bianco opaco · alb mat · valkoinen matto · biały mat
- 32** Schwarz matt · black mat
noir mat · mat zwart · estera negra · nero opaco · negru mat · musta matto · czarny mat
- 35** Holznachbildung · wood imitation
imitation bois · houtimitatie · imitación de madera · effetto legno · imitație de lemn · puujäljitelmä · imitacja drewna
- 42** Anthrazit · anthracite
antracite · antraciet · antracita · antracite · antracit · antrasiitti · antracyt · antrasit
- 80** Schwarz-Gold · black-gold
noir et or · zwart-goud · negro-oro · oro nero · negru-auriu · musta-kulta · czarno złoty
- 87** titanfarbig · titan
titane · titaan · titán · titano · titaniu · titaani · tytanowy · titan
- 88** Silber antik · antique silver
argent antique · antiek zilver · plateado antiguo · argento anticato · argint antic · antiikkihopea · antyczne srebro · gümüş antika
- 99** Roségold · rose gold
or rose · roségoud · oro rosa · oro rosa · aur roz · ruusukulta · różane złoto

Produkteigenschaften

Features · Caractéristiques · Kenmerken · Acabados · Caratteristiche · Caracteristici · Ominaisuudet · Cechy



Schalter · Switch
Interrupteur · Schakelaar · Interruptor · Interruttore · Intrerupator · Kytkin · Przełącznik



Fernbedienung · Remote control
Commande à distance · Afstandsbediening · Mando a distancia · Comando a distanza · Telecomanda · Kauko-ohjain · Pilot



Fußschalter · Footswitch
interrupteur à pédale · Voetschakelaar · Interruptor de pie · interruttore a pedale · comutator picior · Päälle / pois jalkakytin · wyłącznik nożny



Integrierter Dimmer · Integrated dimmer
Variateur intégré · Geïntegreerde dimmer · Regulador integrado · Dimmer integrato · Variator de lumina integrat · Integroitu himmennin · Wbudowany ściemniacz



Schnurschalter · Cable switch
Interrupteur de cordon · Snoerschakelaar · Cable de interruptor · Interruttore su cavo · Intrerupator cu cablu · katkaisin ja johto · Przełącznik na kablu



Sensordimmer · Sensor dimmer
Variateur tactile · Touchdimmer · Regulador con sensor · Touchdimmer · Variator cu senzor · Kosketushimmennin · Czujnik ściemniania



Getrennt schaltbar · Separately switchable
Interrupteurs séparés · Gescheiden schakelbaar · Interruptores separados · Interruttori separati · Intrerupatoare separate · Erikseen kytkettävissä · Oddzileny przełącznik



Lichtfarbe einstellbar · Adjustable light color
Couleur de lumière réglable · Lichtkleur instelbaar · Color de luz regulable · Colore della luce regolabile · Lumina colorata reglabila · Väriämpötila säädettävissä · Regulowana barwa światła

Produkteigenschaften

Features · Caractéristiques · Kenmerken · Acabados · Caratteristiche ·
Caracteristici · Ominaisuudet · Cechy



Schwenkbar · Tilttable
Pivotant · Draaibaar · Pivotante ·
Girevole · Pivotant · Suunnattava · Skråtøny



4 fach TOUCH · 4 level Touch function
Interrupteur tactile 4 niveaux · Touch schakelaar 4 niveaus ·
Función Táctil 4 nivel · Interruttore touch 4 livelli ·
Intrerupator tactil 4 nivele · Kosketuskäyttöinen 4 taso ·
Funkcja dotykowa 4 poziomy



Flexibel · Flexible
Flexible · Flexibel · Flexible · Flessibile ·
Flexibil · Joustava · Elastyczne



Lichtfarbe stufenlos einstellbar ·
Light color infinitely variable
Couleur de lumière infiniment variable · Lichtkleur
traploos instelbaar · Color de luz infinitamente variable ·
Colore della luce infinitamente variabile · Culoare lumină
infini variabilă · Valon väri portaattomasti · Jasny kolor
bezzstopniowo



USB Anschluss · USB connection
Entrée USB · USB aansluiting · Conexión USB ·
Connessione USB · Conexiune USB · USB-liitäntä ·
Połączenie USB



Up and down Beleuchtung · Up and Down lighting
Point lumineux en haut et en bas · Lichtpunt boven en
onder · Luz de arriba y abajo · Luce su e giù · Sus și în
jos lumina · Ylös ja alas valoa · W górę iw dół światło



Dimmbar mit Schalter · Dimmable via switch
Réglable avec interrupteur · Dimbaar via schakelaar ·
Regulable mediante interruptor · Dimmerabile tramite
interruttore · Estompat prin comutator · Himmennettävä
kytkimen · Ściemnialne za pośrednictwem przełącznika



Ohne Leuchtmittel · Lamp(s) excluded
Sans ampoule(s) · Zonder lichtbron(nen) ·
Sin bombilla(s) · Lampadina Esclusa · Fara bec (s) ·
Ilman polttimo (s) · Bez żarówki (s)



Memory Funktion · Memory function
fonction mémoire · Geheugen functie ·
Función de memoria · Funzione memorizzazione ·
functia memorie · Muistitoiminto · Funkcja pamięci



DIP SWITCH
Lichtfarben direkt an der Leuchte einstellbar ·
Colours directly adjustable at the lamp
Les couleurs de la lumière peuvent être réglées directe-
ment sur le luminaire · Lichtkleuren direct instelbaar op de
lamp · Tonalidades de luz ajustables directamente en la
lámpara · Colori della luce regolabili direttamente sulla
lampada · Culori ale luminii reglabile direct de la bec ·
Valon väri asetettävissa suoraan valaisimesta · Barwy
światła można ustawić bezpośrednio na oprawie



Bewegungssensor · Motion sensor
Décteur de mouvement · Bewegungssensor ·
Sensor de movimiento · Sensore di movimento ·
Senzor de mișcare · Liiketunnistin · Czujnik ruchu



Ventilator · Fan
ventilateur · Ventilator · Ventilador · Ventilatore ·
Ventilator · Tuuletin · Wentylator



3 Geschwindigkeitsstufen · 3 modes of speed
3 niveaux de vitesse · 3 snelheidsniveaus ·
3 modos de velocidad · 3 modalități de viteză ·
3 moduri de viteză · 3 nopeustilaa · 3 tryby prędkości



Dämmerungssensor · Dusk sensor
Décteur de crépuscule · Schemeringsensor ·
Sensor de oscuridad · Sensore crepuscolare ·
Senzor de lumina/amurg · Hämärätunnistin ·
Czujnik zmierzchowy



Timer · Timer
Minuterie · Timer · Temporizador · Timer ·
Temporizator · Ajastin · Timer



Solar · Solar
Solaire · Solair · Solar · Solare ·
Solar · Aurinkokenno · Solar



Akkubetrieb · Rechargeable battery operated
Fonctionnement sur batteries rechargeable ·
Opladbare accu · Batería recargable ·
Bateria Ricaricabile · Operabil prin baterie reincarcabila ·
Ladattava akku · Akumulator zasilany bateryjnie



Batteriebetrieb · Battery operated
Fonctionnement sur batterie · Werk op batterijen ·
Funcionamiento con batería · Funzionamento a batteria ·
Funcționare cu baterie · Käyttöaika · Zasilana na baterie



Ladezeit · Charging time
Temps de charge · Opladtid · Tiempo de carga ·
Tempo di carica · Timp de incarcare · Latausaika ·
Czas ładowania



Leuchtdauer · Luminous period
Durée d'éclairage · Brandtijd · Tiempo de
iluminación · Tempo di durata · Perioada de
iluminare · Valaistusaika · Czas świecenia



Flammen-Effekt · Flame effect
Effet de flamme · Vlammeffect · Efecto de
llamas · Effetto fiamma · Efect de flacăra ·
Liekkitehoste · Efekt płomienia



Bewegungssensor und Orientierungslicht ·
Motion sensor and orientation light
Capteur de mouvement et lumière d'orientation ·
Bewegungssensor en oriëntatielicht · Lámpara con sensor
de movimiento y de orientación · Sensore di movimento e
luce di orientamento · Senzor de mișcare și lumină de
orientare · Liiketunnistin ja suuntavallo · Czujnik ruchu i
światło orientacyjne

Artikel-Nr. product no.	Serie series	Seite page	EAN-Nummer EAN-number	Artikel-Nr. product no.	Serie series	Seite page	EAN-Nummer EAN-number
203000132	RUNA	12	4017807522716	312490407	MARLEY	9	4017807523676
204260224	ROYA	44	4017807519006	312490431	MARLEY	9	4017807523690
204260231	ROYA	44	4017807518986	312490432	MARLEY	9	4017807523720
204260242	ROYA	44	4017807453171	312490607	MARLEY	9	4017807523744
204269224	ROYA	44	4017807519044	312490631	MARLEY	9	4017807523805
204269231	ROYA	44	4017807519020	312490632	MARLEY	9	4017807523843
204269242	ROYA	44	4017807453195	403000132	RUNA	13	4017807468076
210860124	TUELA	48	4017807529500	404260142	ROYA	44	4017807453232
210860142	TUELA	48	4017807506129	410860124	TUELA	48	4017807529548
210869124	TUELA	49	4017807529678	410860142	TUELA	48	4017807506167
210869142	TUELA	49	4017807506143	412060142	LUNGA	46	4017807529302
211060131	CAVADO	40	4017807529456	414260142	ROYA	42	4017807529265
211060142	CAVADO	40	4017807506174	426510104	FRANKLIN	2	4017807525342
211069131	CAVADO	40	4017807529463	426510107	FRANKLIN	2	4017807525335
211069142	CAVADO	40	4017807506198	426510108	FRANKLIN	2	4017807525359
212060142	LUNGA	46	4017807529272	426510142	FRANKLIN	2	4017807525366
212069142	LUNGA	47	4017807529289	426510204	FRANKLIN	3	4017807525281
212160242	MERSEY	40	4017807529340	426510207	FRANKLIN	3	4017807525274
212200100	ELISA	10	4017807522013	426510208	FRANKLIN	3	4017807525298
212700104	PURA	10	4017807522129	426510242	FRANKLIN	3	4017807525311
212700107	PURA	10	4017807522112	470660142	AVON	39	4017807529197
212700204	PURA	10	4017807522143	470669142	AVON	36	4017807529203
212700207	PURA	10	4017807522136	504260142	ROYA	44	4017807453218
214260142	ROYA	42	4017807529210	504900104	PERRY	14	4017807522570
214260242	ROYA	42	4017807529234	504900107	PERRY	14	4017807522556
214269142	ROYA	43	4017807529227	504900131	PERRY	14	4017807522518
214269242	ROYA	43	4017807529241	504900132	PERRY	14	4017807522532
270660142	AVON	38	4017807529111	512060142	LUNGA	46	4017807529296
270660242	AVON	38	4017807529159	514260142	ROYA	42	4017807529258
270669142	AVON	36	4017807529135	526510104	FRANKLIN	2	4017807525373
270669242	AVON	37	4017807529166	526510107	FRANKLIN	2	4017807510140
277860142	WITHAM	41	4017807529333	526510108	FRANKLIN	2	4017807510157
302400404	MARLEY	8	4017807523355	526510142	FRANKLIN	2	4017807510164
302400407	MARLEY	8	4017807523416	570660142	AVON	38	4017807529173
302400431	MARLEY	8	4017807523492	570669142	AVON	36	4017807529180
302400432	MARLEY	8	4017807523515	612200100	ELISA	10	4017807522037
302400480	MARLEY	7	4017807523454	612200200	ELISA	10	4017807522051
302400604	MARLEY	8	4017807523577	612400580	MARLEY	6	4017807523980
302400607	MARLEY	8	4017807523591	676240306	HYDRA	4	4017807524871
302400631	MARLEY	8	4017807523638	676240331	HYDRA	4	4017807524901
302400632	MARLEY	8	4017807523652	676240406	HYDRA	4	4017807524925
302400680	MARLEY	7	4017807523614	676240431	HYDRA	4	4017807524949
303000132	RUNA	13	4017807476781	677860142	WITHAM	41	4017807529326
303090132	RUNA	13	4017807476798	802400180	MARLEY	6	4017807523898
312200200	ELISA	11	4017807522006	802400280	MARLEY	6	4017807523911

Artikel-Nr. product no.	Serie series	Seite page	EAN-Nummer EAN-number	Artikel-Nr. product no.	Serie series	Seite page	EAN-Nummer EAN-number
802400380	MARLEY	6	4017807523935	R50821015	SOPHIA	32	4017807481198
802430480	MARLEY	6	4017807523959	R52121111	MAXI	15	4017807526356
R20026242	LAREDO	50	4017807529395	R52121131	MAXI	15	4017807526332
R20026942	LAREDO	50	4017807529418	R52121132	MAXI	15	4017807526349
R27026132	PUNO	50	4017807529357	R55306132	MAIRANA	52	4017807529401
R27036132	PUNO	50	4017807529364	R55336132	CAMARGO	53	4017807529654
R27051106	BOLOGNA	18	4017807525588	R55346132	SANTANA	52	4017807529425
R27051131	BOLOGNA	18	4017807525601	R55356132	ROCA	51	4017807529449
R27071106	PARMA	16	4017807525748	R61095031	TRONDHEIM	30	4017807529579
R27071131	PARMA	16	4017807525762	R61095032	TRONDHEIM	30	4017807529562
R27091106	PERUGIA	20	4017807525861	R61105032	TRONDHEIM	31	4017807529586
R27091131	PERUGIA	20	4017807525885	R62051407	COURSE	22	4017807521481
R32051407	COURSE	22	4017807521504	R62051432	COURSE	22	4017807521498
R32051432	COURSE	22	4017807521542	R62162405	PIVOT	24	4017807521658
R35146132	CAMPUS	53	4017807529432	R62162432	PIVOT	24	4017807521665
R37051106	BOLOGNA	18	4017807525649	R62162499	PIVOT	24	4017807525304
R37051131	BOLOGNA	18	4017807525656	R62472407	ROUTE	26	4017807521696
R37071106	PARMA	16	4017807525700	R62472432	ROUTE	26	4017807521719
R37071131	PARMA	16	4017807525724	R62472499	ROUTE	27	4017807525328
R37091106	PERUGIA	20	4017807525823	R62473407	ROUTE	26	4017807521733
R37091131	PERUGIA	20	4017807525847	R62473432	ROUTE	26	4017807521757
R45356132	ROCA	51	4017807529470	R62473499	ROUTE	27	4017807526011
R50171030	WOODY	35	4017807470772	R62474407	ROUTE	26	4017807521771
R50171080	WOODY	35	4017807523553	R62474432	ROUTE	26	4017807521795
R50171930	WOODY	35	4017807523782	R62474499	ROUTE	27	4017807526059
R50171980	WOODY	35	4017807523768	R62642407	PADELLA	25	4017807521818
R50181030	WOODY	35	4017807470819	R62642432	PADELLA	25	4017807521832
R50181080	WOODY	35	4017807523539	R62642499	PADELLA	25	4017807526080
R50311080	ALBERT	33	4017807524161	R62783406	VENIDA	23	4017807521894
R50311088	ALBERT	33	4017807524093	R62783431	VENIDA	23	4017807521870
R50351035	LUCI	34	4017807524321	R62793406	VENIDA	23	4017807521931
R50491001	JERRY	33	4017807369656	R62793431	VENIDA	23	4017807521917
R50491011	JERRY	33	4017807369663	R67051106	BOLOGNA	18	4017807525625
R50491080	JERRY	33	4017807526226	R67051131	BOLOGNA	18	4017807525632
R50621035	LUXOR	34	4017807524345	R67071106	PARMA	16	4017807525663
R50631035	LUXOR	34	4017807524352	R67071131	PARMA	16	4017807525687
R50691002	JUDY	32	4017807522693	R67083131	BORGHOLM	28	4017807529630
R50691010	JUDY	32	4017807481020	R67083132	BORGHOLM	28	4017807529647
R50691011	JUDY	32	4017807481044	R67091106	PERUGIA	20	4017807525786
R50691012	JUDY	32	4017807481068	R67091131	PERUGIA	20	4017807525809
R50691015	JUDY	32	4017807481082	R67142131	ALESUND	29	4017807529609
R50821002	SOPHIA	32	4017807524383	R67142132	ALESUND	29	4017807529616
R50821010	SOPHIA	32	4017807477870	R67142187	ALESUND	29	4017807529623
R50821011	SOPHIA	32	4017807477887				
R50821012	SOPHIA	32	4017807477894				

TRIO Leuchten GmbH

Gut Nierhof 17
D-59757 Arnsberg

T +49 2931 9666-0
F +49 2931 9666-57

info@trio-leuchten.de
www.trio-leuchten.de

Reality Leuchten GmbH

Gut Nierhof 17
D-59757 Arnsberg

T +49 2931 9666-99
F +49 2931 9666-98

info@reality-leuchten.de
www.reality-leuchten.de

NIEDERSACHEN, SCHLESWIG-HOLSTEIN, HAMBURG, BREMEN

Jens Gebers

T +49 170 1615227
jens.gebers@trio-leuchten.de

BERLIN, BRANDENBURG, MECKL.-VORPOMMERN, SACHSEN, SACHSEN ANHALT, THÜRINGEN

Jörg Bumke

T +49 160 7406860
joerg.bumke@trio-leuchten.de

NORDRHEIN-WESTFALEN

Antonio Capizzi

T +49 172 2598392
capizziantonio@t-online.de

SAARLAND, RHEINLAND-PFALZ, HESSEN

Christian Teller

T +49 171 4521820
christian.teller@trio-leuchten.de

ÖSTERREICH

Wolfgang Melich

T +43 660 5161228
wolfgang.melich@trio-leuchten.de

BADEN WÜRTTEMBERG

Antonio De Simone

T +49 151 58555222
antonio.desimone@trio-leuchten.de

SCHWEIZ

Andreas Huber

T +41 (0) 76 316 22 89
andreas.huber@trio-leuchten.ch

BAYERN, HESSEN

Martin Kluge

T +49 171 7300330
martin.kluge@trio-leuchten.de

Kontakte

Contact · Contact · Contact · Contactar · Contatto · Contact · Yhteydenotto · Kontakt

TRIO International GmbH

Gut Nierhof 17
D-59757 Arnsberg
T +49 2931 9666-587
F +49 2931 9666-56
info@trio-lighting.com
www.trio-lighting.com

FRANCE

Stéphane Papierny

Directeur Commercial France
info.france@trio-lighting.com

Jean Philippe Bailly

info.france@trio-lighting.com
Agent exclusif pour les départements
60, 75001-75004, 75008-75010,
75017-75019, 92, 93, 95

Jean Barel

info.france@trio-lighting.com
Agent exclusif pour les départements
09, 12, 15, 16, 19, 23, 24, 31, 32, 33, 40,
46, 47, 64, 65, 81, 82 et 87

Elsa Seron

info.france@trio-lighting.com
Agent exclusif pour les départements
27, 28, 76

Antoine Masu

info.france@trio-lighting.com
Agent exclusif pour les départements
2a et 2b

Christophe Meulien

info.france@trio-lighting.com
Agent exclusif pour les départements
04, 05, 06, 11, 13, 30, 34, 66, 83 et 84

Stéphane Riebel

info.france@trio-lighting.com
Agent exclusif pour les départements
18, 45, 58, 75005-75007, 75011-75016,
75020, 77, 78, 89, 91, 94

Michel Salamand

info.france@trio-lighting.com
Agent exclusif pour les départements
14, 17, 22, 29, 35, 36, 37, 41, 44, 49, 50,
53, 56, 61, 72, 79, 85 et 86

Vincent Zaepffel

info.france@trio-lighting.com
Commercial pour les départements
02, 08, 10, 25, 51, 52, 54, 55, 57, 59, 62,
67, 68, 70, 80, 88 et 90

Sullivan Nicolas

info.france@trio-lighting.com
Agent exclusif pour les départements
01, 03, 07, 21, 26, 38, 39, 42, 43, 48, 63,
69, 71, 73 et 74

NEDERLAND

Karl Stok / Bas Martin

info.nederland@trio-lighting.com

BELGIUM/BELGIQUE

Yves van den Berghe

info.belgium@trio-lighting.com

ITALIA

TRIO Lighting Italia s.r.l

Via Padre Masciadri, 2 H
IT-22066 Mariano Comense (CO)
T +39 317 477 55
F +39 313 551 560
commerciale@trio-lighting.com

ESPAÑA

TRIO Lighting Ibèrica SL

C/ Can Lietget n°9 nave9
Pol. Ind. Can Roqueta
08206 Sabadell
T +34 9 35 45 86 30
F +34 9 33 96 45 48
info.iberica@trio-lighting.com

SUOMI

TRIO Lighting Scandinavia Oy

Malmin raitti, rappu 17 B
00700 Helsinki
T +358 10 23 13 390
F +358 10 23 13 399
info.scandinavia@trio-lighting.com
Our Scandinavian organisation represents TRIO
also in Sweden, Norway, Estonia, Latvia
and Lithuania

GREAT BRITAIN

TRIO Lighting UK Ltd.

Unit 5, Hemmells Park Hemmells, Laindon
Essex
SS1s 6GF
T +44 12 68 88 95 95
F +44 12 68 88 95 96
sales@trio-lightinguk.com

ROMANIA

Gina Ionita

info.romania@trio-lighting.com



TRIO Leuchten GmbH

Gut Nierhof 17
D-59757 Arnsberg

T +49 2931 9666-0
F +49 2931 9666-57

info@trio-leuchten.de
www.trio-leuchten.de

Reality Leuchten GmbH

Gut Nierhof 17
D-59757 Arnsberg

T +49 2931 9666-99
F +49 2931 9666-98

info@reality-leuchten.de
www.reality-leuchten.de

TRIO International GmbH

Gut Nierhof 17
D-59757 Arnsberg

T +49 2931 9666-587
F +49 2931 9666-56

info@trio-lighting.com
www.trio-lighting.com

