

2022 / 2023

 **TRIO**
LIGHTING FOR YOU





Intelligente Lichtsteuerung · smart lighting control

44 - 59

contrôle d'éclairage intelligent · slimme lichtregeling ·
control de iluminación inteligente · controllo intelligente dell'illuminazione ·
control inteligent al iluminatului · älykäs valaistuksen ohjaus ·
Inteligentne sterowanie światłem



Leuchtenfamilien & Kombinationen · Families & coordinates

60 - 191

Familles & coordonnés · Families & combinaties · Familias & coordinados ·
Famiglie & coordinati · Famillii & Coordonate ·
Tuoteperheet & yhdistettävät tuotteet · Rodzinne orawy & kombinacje

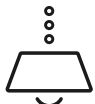

Pendelleuchten & Kronen · Pendants & chandeliers

192 - 245

Lustres & suspensions · Hanglampen & kroonluchters ·
Colgantes y Lámparas · Lampadari e sospensioni · Lustre si pendule ·
Riippu- & kruunu · Wiszące i żyrandole



Leuchten im Vintage Stil · Vintage style luminaires

246 - 295

Luminaire style Vintage · Armaturen in Vintage stijl ·
Lámparas vintage · Apparecchi stile vintage · Corpuri de iluminat vintage ·
Vintage valaisimet · Lampy w stylu vintage



Wand- und Deckenleuchten · Wall & Ceiling lamps

296 - 419

Applique & plafonniers · Wandlampen & plafonnières ·
Apliques y plafones · Applique e plafoniere · Plafoniere si aplice ·
Seinä- & katto · Sufitowe i ścienne

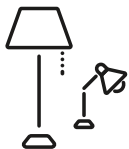

Steh- und Tischleuchten · Table- & floor lamps

420 - 497

Lampes de table & lampadaires · Tafel- & vloerlampen ·
Sobremesas y lámparas de pie · Lampade da tavolo e piantane ·
Veioze si lampadare · Pöytä- & lattia · Stołowe i podłogowe



Spotserien · Spots

Spotterie · Spots · Focos · Faretti · Spoturi · Spotit · Reflektorki

498 - 529



DUOline Schienensystem (230 V) · track system (230 V)

Système de voie à deux phases (230 V) · 2-fase-spoorsysteem (230 V) ·
Sistema de rieles en 2 fases (230 V) · Sistema a binario bifase (230 V) ·
Sistem de piste cu 2 faze (230 V) · 2-vaihekiskojärjestelmä (230 V) ·
2-fazowy system prowadnic (230 V)

530 - 553



Einbauleuchten · Recessed spots

Spots encastrés · Inbouwspots · Focos empotrables ·
Faretti incasso · Spoturi incastrate · Upotetut spotit · Oprawy wbudowane

554 - 571

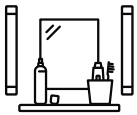

Badezimmerleuchten · Bathroom lighting

Éclairage salle de bains · Badkamer verlichting ·
Iluminación de cuarto de baño · Illuminazione per bagno ·
Iluminat baie · Kylpyhuone valaistus · Oświetlenie łazienkowe

572 - 605



Leuchtmittel · Light sources

Ampoules · Lichtbronnen · Fuentes de luz ·
Lampadine · Becuri · Valonlähteet · Źródła światła

606 - 615



Spezifikationen · Specifications

Spécifications · Specificaties · Especificaciones ·
Specifiche · Specificații · Tekniset tiedot · Specyfikacje

624 - 653



Kontakte · Contact

Contact · Contact · Contactar ·
Contatto · Contact · Yhteydenotto · Kontakt

654 - 655

LIGHTING FOR YOU



FR

Chers clients et partenaires commerciaux,

Un environnement de vie dans lequel vous vous sentez confortable est une pièce de qualité de vie !

Nos dernières tendances d'éclairage montrent comment les lieux de vie peuvent être individuellement conçus et élégamment éclairés. Qu'il soit classique ou moderne, chaleureux et naturel, puriste ou glamour - laissez-vous inspirer !

Enjoy browsing through our new catalogue!

NL

Beste klanten en zakenpartners,

Een leefomgeving, waarin u zich comfortabel voelt, vormt een stukje levenskwaliteit!

Onze nieuwste verlichtingstrends tonen hoe leefruimtes individueel ontworpen en verfijnd verlicht kunnen worden. Of het nu klassiek of modern, warm en natuurlijk, purist of betoverend is - laat inspireren!

Geniet van grasduinen doorheen onze nieuwe catalogus!

D

Liebe Kund*innen und Geschäftspartner*innen,
eine Wohnumgebung in der man sich wohlfühlt, ist ein Stück Lebensqualität!

Unsere neuesten Leuchten-Trends zeigen, wie Wohnbereiche individuell gestaltet und anspruchsvoll ausgeleuchtet werden können. Ob klassisch oder modern, warm und natürlich, puristisch oder glamourös – lassen Sie sich inspirieren!
Viel Vergnügen beim Durchstöbern unseres neuen Kataloges!

GB

Dear customers and business partners,

A living environment in which you feel comfortable is a piece of quality of life!

Our latest lighting trends show how living areas can be individually designed and sophisticatedly illuminated. Whether classic or modern, warm and natural, purist or glamorous - let yourself be inspired!

Enjoy browsing through our new catalogue!





ES

Queridos clientes y socios,

¡un ambiente en el que se sientan cómodos es parte vital de la calidad de vida!

Nuestras últimas tendencias en iluminación muestran como se pueden diseñar individualmente los ambientes e iluminarlos de forma sofisticada. Ya sea de forma clásica o moderna, cálida y natural, purista o glamorosa - ¡inspírate!

¡Disfruta de nuestro nuevo catálogo!

IT

Cari clienti e partner commerciali,

Un ambiente in cui ci si sente a proprio agio è un componente essenziale della qualità della vita!

Le nostre ultime tendenze in fatto di illuminazione mostrano come gli spazi abitativi possano essere progettati in modo personalizzato e illuminati in modo sofisticato. Classico o moderno, caldo e naturale, purista o glamour: lasciatevi ispirare! Divertitevi a sfogliare il nostro nuovo catalogo!

RO

Dragi clienți și parteneri de afaceri,

Un mediu de viață în care vă simțiți confortabil este parte de calitate a vieții! Ultimele noaste tendințe în iluminat arată cum zonele de locuit pot fi proiectate individual și iluminate sofisticat. Clasic sau modern, cald și natural, purist sau fastuos - lăsați-vă inspirați!

Bucurați-vă răsfoind noul nostru catalog!

FI

Hyvät asiakkaat ja yhteistyökumppanit.

Asuinympäristö, jossa tunnet olosi mukavaksi, on osa elämänlaatua! Viimeisin valaistustrendimme näyttää, kuinka olohuoneet voidaan suunnitella yksilöllisesti ja valaista hienostuneesti. Klassista tai modernia, lämmintä ja luonnollista, vähäeleistä tai yllleistä - anna itsesi inspiroitua!

Nauti uuteen kuvastoomme tutustumisesta!

PL

Szanowni Klienci i Partnerzy Handlowi,

Mieszkanie, w którym czujemy się komfortowo, to element jakości życia!

Nasze najnowsze trendy oświetleniowe pokazują, jak można indywidualnie projektować i oświetlać pomieszczenia mieszkalne. Klasyczne lub nowoczesne, ciepłe i naturalne, purystyczne lub efektowne - pozwólcie się zainspirować!

Zapraszamy do przeglądania naszego nowego katalogu!



SERIENÜBERSICHT

Family overview · Aperçu par famille · Overzicht per familie · Vista general por familia ·
Panoramica per famiglia · Prezentare pe familii de produse · Perheen yleiskuvaus · Przegląd rodziny

AARON	46	BERLIN	477	CLAAS	430	DOLOMITE	566	GRANBY	444
ADRIAN	406	BISCUIT	345	CLAPTON	502	DONNA	478	GRANT	211
ADRIANO	401	BLAZE	86	CLARIMO	578	DOWNEY	325	GRIFFIN	52
AGRA	272	BODRUM	355	CLARK	434	DURBAN	200	GROOVY	304
AICK	210	BOLDER	387	CLAYTON	214	ECCO	418	HARPER	96
ALEGRO	208	BOLSA	576	CLEO	378	EDGE	88	HARRIS	262
ALICIA	172	BOOLAN	237	CLERMONT	218	EDWARD	469	HEDDA	284
ALINO	417	BRAD	251	COLIN	242	ELEMENT	383	HENK II	476
AMSTERDAM	486	BRADLEY	250	COLINA	409	ELISA	182	HENLEY	265
ANDREUS	384	BRANTFORD	446	COLINO	282	ELMAU	278	HOLLY	238
ANGELO	594	BULLET	352	CONCHA	399	ELSA	229	HOSTEL	118
ANTIBES	548	BURTON	110	CONCRETE	524	EMERALD	480	HOTEL	122
APART	602	CALAIS	236	CONDUS	605	FABIO	582	HOUSTON	525
ARAGON	416	CALCIO	462	CONNOR	231	FERNANDO	342	HYDRA	322
ARANGO	450	CAMDEN	104	CONO	404	FIGO	59	IBIS	120
ARGENTINA	439	CAMILLA	599	COOKIE	344	FILIGRAN	467	ICARO	471
ARINO	390	CAMILLUS	550	CORBIE	331	FILO	138	INDIRA	320
ARIZONA	450	CAMPO	404	CORD	293	FISHERMAN	295	INGA	280
ARVIN	319	CANDELA	234	CORE	558	FLETCHER	162	IRVINE	314
ARY II	482	CANNES II	426	CORTEZ	228	FLEXO	496	IVAR	266
ASCARI	574	CARBONADO	408	CRISTO	478	FORESTER	270	JASMIN	294
AURA	556	CARICO	518	CROSS	148	FRANCIS	74	JASPER	165
AURORA	378	CARLO	398	CRYSTEL	351	FRANKLIN	62	JIMMY	552
AVA	487	CARRERA	76	CUADRO	388	FRED	413	JIVE	80
AVUS	308	CASSIO	422	CUBE	396	FREDDY	240	JOHANN	291
BAJO	244	CAYA	298	CURL	202	FRODENO	601	JOOST II	476
BALDO	386	CENTO	341	CURTIS	389	FYNN II	481	JORDAN	381
BALINI	170	CESAR	369	CURVA	371	GALE	306	JUDITH	286
BANGKOK	440	CHARIVARI	70	DAKOTA	468	GANADO	316	JURA	568
BARON	132	CHARLESTON	311	DAVI II	483	GARDA	116	KAGAWA	358
BARONESS	130	CHARLY	56	DEACON	102	GAYA	258	KAZAN	460
BARRIE	448	CHICO	406	DELHI	254	GIADA	593	KENAI	570
BELA	150	CHIRON	226	DIALLO	160	GIANNI	575	KERALA	100
BELFAST	92	CHIROS	379	DIAMO	54	GIRONA	338	KHAN	252
BELL	260	CHRIS	452	DIEGO	242	GONZALO	368	KIMI	494
BELLARI	98	CINZIA	577	DISCALGO	142	GOTHAM	288	KOLIAN	586
BERGAMO	458	CITIZEN	50	DIVO	402	GRANADA	302	KORBA	276

LACAL	209	MELBY	51	PHOENIX	334	SALERNO	79	TOKYO	362
LACAPO	392	MELVIN	395	PIERA	584	SALINAS	90	TOMMY	552
LANA	407	MICHAEL	522	PIET II	485	SALSA	310	TOSH	274
LANCE	474	MIGUEL	394	PIRIN	566	SAMURAI	364	TOULON	403
LAON	412	MIKO	363	PLANT	271	SANDRINA	188	TRACY	437
LARA	292	MINSK	235	PLATON	400	SANNA	290	TRADITIO	158
LEON	508	MITA	356	POLLY	492	SANTO II	451	TRAJAN	206
LEVISTO	520	MONZA	456	POLO	492	SEASONS	374	TRAY	136
LIÈGE	473	MOONY	370	PONTE	435	SEDONA	312	TRINITY	400
LIGARA	412	MORRISON	199	PRIMO	407	SEIKO	362	TUBULAR	204
LILLY	410	MOTEL	433	PRONTO	496	SEQUENCE	66	TUCSON	313
LINE	386	NAGANO	367	PURA	405	SHANGHAI	441	UMBERTO	603
LINO	590	NALIDA	56	PURE	166	SHOGUN	364	VALENTE	178
LIVIA	227	NANDOR	428	QUEBEC	443	SIGNA	189	VAPORE	174
LORELEY	239	NAPOLI	156	QUINTA	372	SIMEO	415	VARIO	488
LORENA	176	NARCOS	466	RADIATOR	544	SOLA	438	VENTURA	479
LORENZO	592	NIKOSIA	186	RADO	489	SORRENTO	94	VERONA	459
LOUIS	393	NORIAKI	365	RAMON	419	SPIRELLI	184	VERUS	326
LUCERNA	232	NURIA	72	RAVEN	330	SPLIT	453	VIEW	596
LUGANO	346	OAKLAND	77	RAY	579	STAMINA	241	VIOLA	243
LUGO	300	OKINAWA	361	REPOSA	373	STEAM	528	VISTA	58
LUIGI	382	ONTARIO	230	RILA	564	SUBARA	359	WACO	332
LUIS II	480	ONYX	224	ROBIN	180	SWEETY	190	WALES	396
LUMINA	212	OSAKA	360	ROCCO	580	SYDNEY	78	WANDA	385
LUNAR	366	OXFORD	324	RODERIC	488	TAILOR	249	WINONA	317
LUPO	493	PAGO	506	RODRIGO	264	TAJO	497	XAVI	604
LYON	108	PALI	376	ROMA	411	TAMIL	140	YAVA	309
MACAU	203	PAMIR	560	ROMINO II	238	TANDORI	427	ZAGROS	562
MADISON	194	PANTILON	57	RONDO	82	TANJA	290	ZANDOR	134
MADRAS	268	PAOLO	600	ROPE	287	TAURUS	500	ZAZOU	410
MARIO	382	PAPER	245	ROTIN	286	TENALI	273	ZENIA	598
MARLEY	510	PARIS II	431	ROUBAIX	544	TEXEL	472	ZEUS	340
MARRIOT	380	PAROS	547	ROXIE	145	THEATRO	597	ZORRO	397
MARTA	402	PAVIA	454	RUBY	329	THIAGO	48	ZUCCA	244
MATS II	484	PEACOCK	354	RUNA	285	TILLII	482		
MATTIMO	588	PEREZ	436	RUSTICA	152	TIRIAC	308		
MELA	216	PERRY	495	SABIA	424	TITUS	328		

PENDELLEUCHTEN & KRONEN

Pendants & chandeliers · Lustres & suspensions · Hanglampen & kroonluchters · Colgantes y Lámparas · Lampadari e sospensioni · Lustre si pendule · Riippu- & kruunu · Wiszące i żyrandole



NURIA 72



MACAU 203



DURBAN 200



AARON 47

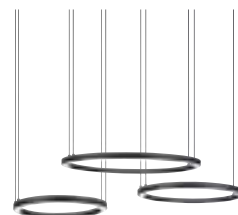

MORRISON 199

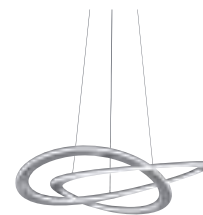

OAKLAND 77



TRAY 136



FRANKLIN 65



TUBULAR 204



MADISON 194



CLERMONT 218

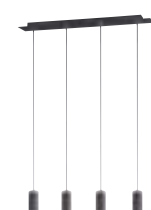

MARLEY 220



SEQUENCE 67



BLAZE 86



TRAJAN 206



SALINAS 90



EDGE 88



GRANT 211

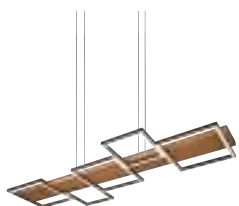

HARPER 96



KERALA 101

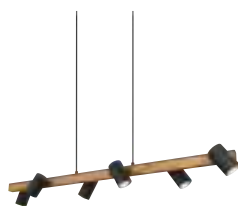

MARLEY 222

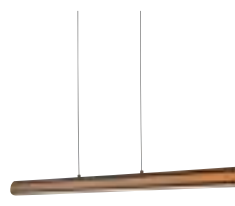

DEACON 103

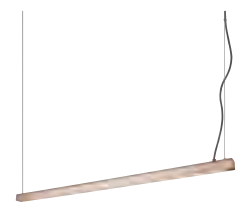

BELLARI 98



ALEGRO 208



SALERNO 79



LACAL 209



FREDDY 240



LEVISTO 240



STAMINA 241



FLETCHER 162



FILO 138



ZANDOR 135



BARON 132



BARONESS 130



JASPER 165



HOLLY 238



FRANCIS 74



CARRERA 76



RONDO 82



AICK 210



BELFAST 93



CURL 202



CHARIVARI 70



PENDELLEUCHTEN & KRONEN

Pendants & chandeliers · Lustres & suspensions · Hanglampen & kroonluchters · Colgantes y Lámparas · Lampadari e sospensioni · Lustre si pendule · Riippu- & kruunu · Wiszące i żyrandole

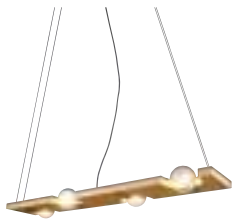

TAILOR 249



BRAD 251

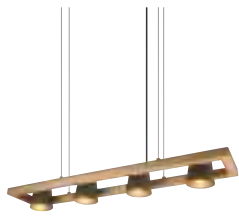

BELL 261



AGRA 272



TENALI 273



KHAN 255

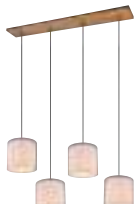

ELMAU 278



KORBA 277



INGA 280



HEDDA 284



RUNA 285



TOSH 275



FISHERMAN 295



JASMIN 294



GOTHAM 288

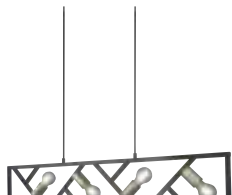

BELA 150

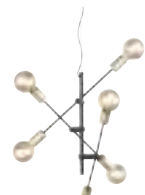

CROSS 148

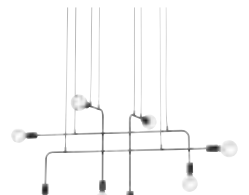

CONNOR 231



ROXIE 145



RUSTICA 152



LIVIA 227



ELSA 229



NAPOLI 156



TRADITIO 158



CAMDEN 104



HOTEL 123



BURTON 110



GARDA 117



CORTEZ 228



IBIS 120



LORENA 176



VAPORE 175



VALENTE 178



ALICIA 172



LUMINA 212



CLAYTON 214



ELISA 182



SIGNA 189



SPIRELLI 185



SANDRINA 188



NIKOSIA 187



VIOLA 243



COLINO 282



DEHLI 255



GAYA 258

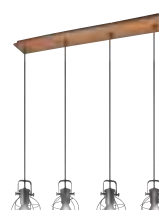

MADRAS 268



PLANT 271



FORESTER 270



HARRIS 262



HENLEY 265



TAMIL 140



IVAR 266



TANJA 290



SANNA 290



CORD 293



ONYX 224



DISCALGO 142



ROMINO II 238



CHIRON 226



ONTARIO 230



BOOLAN 237



CANDELA 234



MINSK 235



LUCERNA 232



LORELEY 239



HOTEL 135



HOSTEL 119



MELA 216

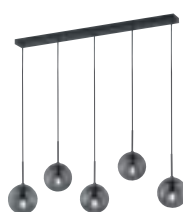

BALINI 170



ROBIN 180



CALAIS 236



PURE 167



COLIN 242



DIEGO 242



SWEETY 190



ZUCCA 244



BAJO 244



PAPER 245

DECKENLEUCHTEN

Ceiling lamps · Plafonniers · Plafonnières · Plafones ·
Plafoniere · Plafoniere · Kattvalaisimet · Plafony



CAYA 298



NURIA 72



FRANCIS 74



CARRERA 76



GALE 306



AARON 46



JIVE 80



SALSA 310



YAVA 309



RONDO 82



AVUS 308



CITIZEN 50



CHARLESTON 312



IRVINE 314

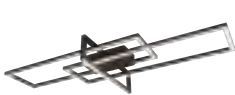

SALINAS 90



GANADO 316



BLAZE 86



HARPER 96



GROOVY 304

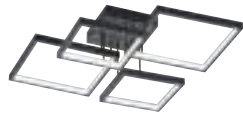

SORRENTO 94

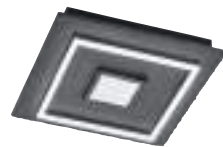

CORBIE 331

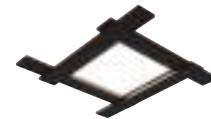

BELFAST 92

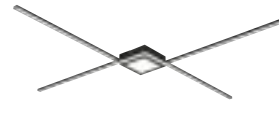

OXFORD 324



TIRIAC 308



BELLARI 150



MARLEY 510



BULLET 352

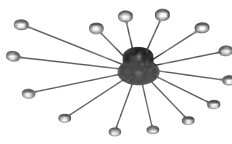

PEACOCK 354

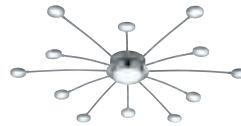

BODRUM 355



SYDNEY 78



CHARIVARI 70



LUGO 300



GRANADA 303



DEACON 102



FRANKLIN 62



TRAY 136



GIRONA 338



BARON 132



ZANDOR 134



BARONESS 130



WINONA 317



SEDONA 312



OAKLAND 77

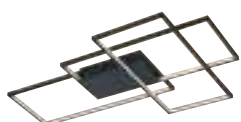

THIAGO 48

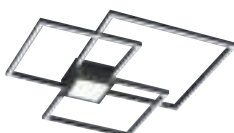

HYDRA 322



DOWNEY 325



TUCSON 313



SEDONA 312



MELBY 51



ARVIN 319



INDIRA 320



SEQUENCE 66



COOKIE 344



BISCUIT 345



FERNANDO 342



DECKENLEUCHTEN

Ceiling lamps · Plafonniers · Plafonnières · Plafones ·
Plafoniere · Plafoniere · Kattvalaisimet · Plafony



VERUS 326



OKINAWA 361



TOKYO 362



MIKO 363



OSAKA 360



NORIAKI 365



CESAR 369



LUNAR 366



SAMURAI 364



SHOGUN 364



CHARLY 56



GONZALO 368



CAMDEN 104



LUGANO 348



HOTEL 122



HOTEL 124



LUGANO 346



DIAMO 54



BURTON 112



ALICIA 172



CRYSTEL 351



LORENA 176



VALENTE 178



VAPORE 174



TAILOR 249

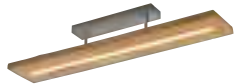

BRAD 251

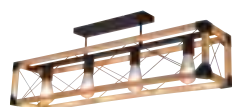

TENALI 273



COLINO 282



KERALA 100



BELL 260



JOHANN 291

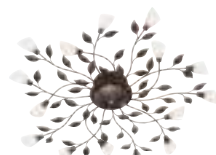

REPOSA 373



NAPOLI 156



ROXIE 146



TRADITIO 158



QUINTA 372



SPIRELLI 184



COLINA 409



SIGNA 189



PRIMO 407



CHICO 406



CARBONADO 408



MITA 356



SUBARA 359



KAGAWA 358



RUBY 329



NALIDA 56



SEIKO 362



TITUS 328



GRIFFIN 52



WACO 332



PHOENIX 334



CENTO 341



ZEUS 340



MOONY 370



GARDA 116



HOSTEL 118



IBIS 120

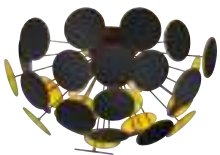

DISCALGO 142

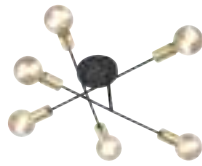

CROSS 148



DIALLO 160



PALI 376



SEASONS 374

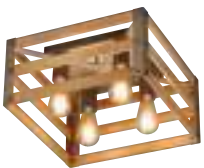

KHAN 252



HEDDA 284



INGA 280



TAMIL 140



KORBA 276



ELMAU 278



RUSTICA 152



CHIROS 379



ELISA 182



NIKOSIA 186



ADRIAN 406



SANDRINA 188



LANA 407



SWEETY 190



LILLY 410



CLAPTON 503



CURVA 371

WANDLEUCHTEN

Wall lamps · Appliques · Wandlampen · Apliques ·
Appliques · Lämpi de perete · Seinävalaisimet · Scienne



BELFAST 92



MIGUEL 394



ADRIANO 401



CARLO 398



WALES 396



LOUIS 393



MELVIN 395



CONCHA 399



FIGO 59



RAVEN 330



MARLEY 513



MARIO 382



SUBARA 359



TRINITY 400



PLATON 400



CUBE 396



ROMA 411



ZAZOU 410



SEQUENCE 66



LUGO 300



MARRIOT 380



CASSIO 422



ANDREUS 384

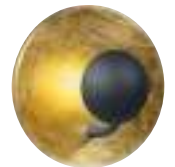

AURORA 378



KERALA 100



PALI 376



ARINO 390



BRADLEY 250



BRAD 251

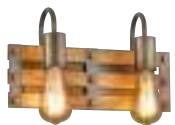

KHAN 252



HOTEL 128



BALDO 386



BOLDER 387



LINE 386



DIALLO 160



GOTHAM 288



ELISA 182



COLINA 409



SANDRINA 188



SPIRELLI 184



NIKOSIA 186



PURA 405



LACAPO 392



VISTA 58



ZANDOR 134



ZORRO 397



LUIGI 382



JORDAN 381



ELEMENT 383



KAZAN 460



EDWARD 469



CUADRO 368



CHIROS 379



CLEO 378



LYON 108



PURE 168



CURTIS 389



WANDA 385



GAYA 258



TRADITIO 159



LUCERNA 232



RUNA 285



CAMPO 404



CONO 404



TOULON 403



CARBONADO 408



SIGNA 189



DIVO 402



MARTA 402



SWEETY 190

SPOTSERIEN

Spots · Spotterie · Spots · Focos · Faretti · Spoturi · Spotit · Reflektorki



CLAPTON 503



NARCOS 504



MARLEY 514



TAURUS 500



LEON 508



PAGO 506



MICHAEL 522



CONCRETE 524



LEVISTO 520



CARICO 518



ROXIE 526



HOUSTON 525



BELL 260



MARLEY 510



MADRAS 268



TOSH 274



DEHLI 256



LEVISTO 413



LAON 412



FRED 413



LIGARA 412



WANDA 385

2-PHASEN-SCHIENENSYSTEM

2-phase track system · Système de voie à deux phases · 2-fase-spoorsysteem · Sistema de rieles en 2 fases · Sistema a binario bifase · Sistem de piste cu 2 faze · 2-vaihekiskojärjestelmä · 2-fazowy system prowadnic



RADIATOR 544



ROUBAIX 544



LEON 544



MARLEY 546



ANTIBES 548



TOMMY 552



PANEL 550

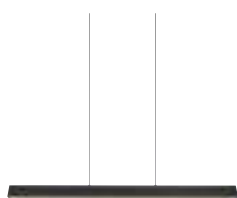

PAROS 547



MARLEY 546



ONTARIO 548



JIMMY 552



HOSTEL 552



BURTON 114

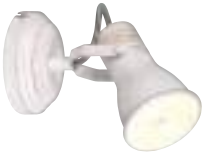

STEAM 528



DIALLO 548



TOSH 548



CAMILLUS 550



HOTEL 552



HOTEL 552



HOSTEL 553



TISCHLEUCHTEN

Table lamps · Lampes de table · Tafellampen · Sobremesas ·
Lampa da tavolo · Veioze · Pöytävalaisimet · Lampy stołowe



SABIA 424



CASSIO 422



TANDORI 427



LYON 108



PARIS II 431



NANDOR 428



BURTON 110



LORENA 176



VAPORE 174



ALICIA 172



ROBIN 180



KERALA 101



SEQUENCE 67



BLAZE 86



EDGE 88



TEXEL 472



CHARIVARI 71



FRANKLIN 62



BERLIN 477



PURE 168



JOOST II 476



HENK II 476



DONNA 478



VENTURA 479



CRISTO 476



FYNN II 481



ARY II 482



TILL II 482



DAVI II 483



AVA 487



PAVIA 454



MONZA 456



POLO 492



CALCIO 462



NARCOS 505



CURTIS 490



ROXIE 145



JASPER 165



PERRY 495



FLETCHER 162



DIALLO 161



KIMI 494



HOSTEL 118



HOTEL 129



MATS II 484



PIET II 485



GARDA 116



TAILOR 249



INGA 280



ELMAU 278



KORBA 276



RONDO 82



SORRENTO 94



SYDNEY 78



EMERALD 480



LUIS II 480



LARA 292



TRADITIO 158



RUSTICA 154



RADO 489



RODERIC 488



AMSTERDAM 486



VARIO 488



BERGAMO 458



POLLY 492



LUPO 493



MARLEY 464



TOSH 275



PRONTO 496



FLEXO 496



TAJO 497

STEHLEUCHTEN

Floor lamps · Lampadaires · Vloerlampen · Lámparas de pie · Piantane · Lampadare · Lattiavalaisimet · Lampy podłogowe



SABIA 424



CASSIO 422



CAMDEN 104

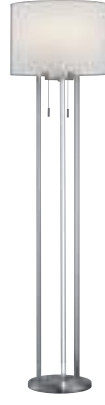

TANDORI 427



CANNES II 426



PARIS II 431



HOTEL 126



CLARK 434



PONTE 435



TRACY 437



HOSTEL 119



PEREZ 436



VAPORE 175



BALINI 170



ALICIA 172



LANCE 474



FILO 138



PURE 168



TAILOR 249



KHAN 253



BELL 260



HARRIS 262



RODRIGO 264



DEHLI 254



LYON 408



NANDOR 428



CLAAS 430



MOTEL 433



HOTEL 127



BURTON 112



TEXEL 472



DIALLO 161



BELA 150



CROSS 148



LIÈGE 473



IVAR 266



DEHLI 256



GAYA 258



TOSH 275



KORBA 277



RUNA 285

STEHLEUCHTEN

Floor lamps · Lampadaires · Vloerlampen · Lámparas de pie ·
Piantane · Lampadare · Lattiavalaisimet · Lampy podłogowe



NURIA 73



JIVE 80



RONDO 83



SORRENTO 94



SALERNO 79



SYDNEY 78



PANTILON 57



FRANKLIN 62



BRANTFORD 446



GRANDBY 444



BARRIE 448



QUEBEC 443



SPLIT 453



SANTO II 451



ARIZONA 450



CHRIS 452



ARANGO 450



RUSTICA 154



PAVIA 454



FRANKLIN 64

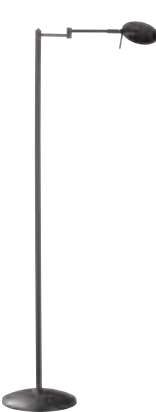

KAZAN 460

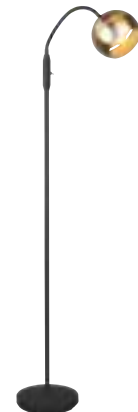

FLETCHER 162



MARLEY 464



ROXIE 145



CHARIVARI 71



SEQUENCE 67



BLAZE 86



EDGE 88



BELLARI 98



KERALA 101



ARGENTINA 439



SOLA 438



BANGKOK 440

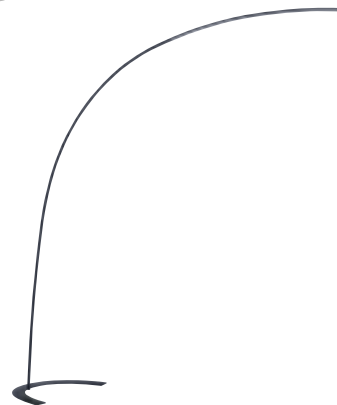

SHANGHAI 441

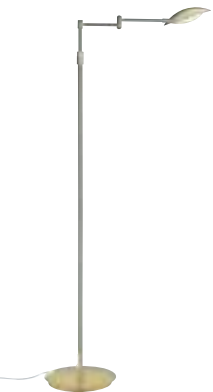

CALCIO 462



BERGAMO 458



VERONA 459



FILIGRAN 467



MONZA 456



JASPER 165



ICARO 471



EDWARD 469



NARCOS 466



DAKOTA 468



FREDDY 470

BADEZIMMERLEUCHTEN H_2O

Bathroom lighting · Éclairage salle de bains · Badkamer verlichting · Iluminación de cuarto de baño ·
 Illuminazione per bagno · Iluminat baie · Kylpyhuone valaistus · Oświetlenie łazienkowe



ASCARI 574



CINZIA 577



CAMILLA 599



APART 602



CLARIMO 578



CONDUS 605



BOLSA 576

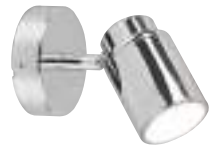

ANGELO 594



RAY 579



BOLSA 576



VIEW 596



GIANNI 575



PIERA 584



ROCCO 580



FABIO 582



MATTIMO 588



KOLIAN 586



XAVI 604

EIN- UND UNTERBAULEUCHTEN

Recessed and cabinet lightings · Eclairages encastrés et éclairages sous armoire ·
 Inbouwverlichtingen en verlichtingen onder de kastjes · Luces empotrables y luces para la parte inferior
 del armario · Lampade da incasso e lampade sottopensili · Lumini încastrate și lumini sub dulap ·
 Uputettavat valaisimet ja kaapinalusvalaisimet · Oprawy wpuszczane oraz oprawy podszafkowe



AURA 556



CORE 558



ZAGROS 562



ZAGROS 562



PAMIR 560



PAMIR 560



JURA 568



JURA 568



DOLOMITE 566



PIRIN 566



KENAI 570



SIMEO 415



ARAGON 416



ALINO 417



RAMON 419

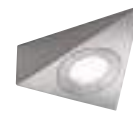

ECCO 418



UMBERTO 603



FRODENO 601



PAOLO 600



THEATRO 597



LINO 590



LORENZO 592



GIADA 593



ZENIA 598



RILA 564



RILA 564



TREND HIGHLIGHTS 2022 / 2023



FRANKLIN
Seite / page 62

Ⓒ The colour black is noble and timeless. Black is also the colour of individuality, aesthetics and elegance. As well-placed eye-catchers, these expressive lighting ideas visibly enhance the immediate surroundings, adding an extravagant touch to living space

Ⓖ La couleur noire est noble et intemporelle. Le noir est également la couleur de l'individualité, de l'esthétique et de l'élégance. En tant qu'accroches bien placées, ces idées d'éclairage expressif améliorent visiblement les alentours immédiats, en ajoutant une touche extravagante aux lieux de vie.

Ⓓ De kleur zwart is prachtig en tijdloos. Zwart is ook de kleur van individualiteit, esthetiek en elegantie. Als goed geplaatste blikvangers versterken deze expressieve verlichtingsideeën de onmiddellijke omgeving, een extravagant vleugje toevoegend aan leefruimtes.



Ⓒ Die Farbe Schwarz ist edel und zeitlos. Schwarz ist auch die Farbe der Individualität, der Ästhetik und der Eleganz. Als wohlplatziertes Blickfang werden diese ausdrucksstarken Lichtideen das unmittelbare Umfeld sichtbar auf, und verleihen Wohnräumen einen extravaganten Touch.

Ⓒ El color negro es noble y atemporal. Es el color de la individualidad, la estética y la elegancia. Estas expresivas ideas de iluminación, que funcionan como focos de atención bien establecidos, realzan visiblemente el entorno y añaden un toque extravagante a los ambientes.

soft black



29

Ⓜ Il colore nero è nobile e senza tempo. Il nero è anche il colore dell'individualità, dell'estetica e dell'eleganza. Queste idee illuminotecniche, ben posizionate, valorizzano visibilmente l'ambiente circostante, aggiungendo un tocco stravagante agli spazi abitativi.

Ⓜ Negru este o culoare nobilă și eternă. Negru este de asemenea culoarea individualității, esteticii și eleganței. Ca elemente bine plasate de atragere a atenției, aceste idei de iluminat expresive îmbunătățesc vizibil imediata vecinătate, adăugând o nuanță extravagantă spațiilor de locuit.

Ⓜ Musta on värinä jalo ja ajaton. Musta on myös yksilöllisyyden, estetiikan ja eleganssin väri. Hyvinsijoitettuina katseenvangitsijoina nämä vaikuttavat valaistusideat rikastavat välitöntä ympäristöään antaen asuinympäristöille yllälistä tunnelmaa.

Ⓜ Kolor czarny jest szlachetny i ponadczasowy. Czerń to także kolor indywidualności, estetyki i elegancji. Te ekspresyjne pomysły oświetleniowe przyciągają wzrok, są dobrze rozmieszczone i wyraźnie podkreślają najbliższe otoczenie, dodając ekstrawagancki akcent przestrzeniom mieszkalnym.

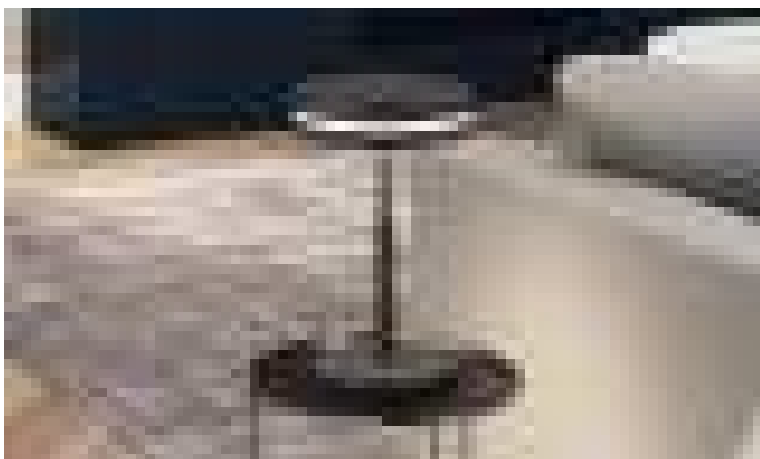

TREND HIGHLIGHTS 2022 / 2023

Ⓧ Besonders charakteristisch für diesen Trend ist die Kombination aus schwarzen und goldfarbenen Design-Elementen. Die elegant geschwungenen Formen verleihen diesen Leuchten einen besonderen Charme, und Wohnräumen eine stilvolle und romantische Note.

Ⓤ Particularly characteristic of this trend is the combination of black and gold-coloured design elements. The elegantly curved shapes give these luminaires a special charm and living spaces a stylish and romantic touch.

Ⓥ Une caractéristique particulière de cette tendance est la combinaison d'éléments de conception noirs et dorés. Les formes élégamment courbes donnent à ces luminaires un charme particulier et aux espaces de vie une touche élégante et romantique.



BLAZE
Seite / page 86



Ⓝ In het bijzonder kenmerkend voor deze trend is de combinatie van zwart en goud-gekleurde designelementen. De elegant gebogen vormen bezorgen deze verlichtingstoestellen een bijzondere charme en leefruimtes een stijlvolle en romantische toets.

Ⓞ La combinación de elementos de diseño de color negro y dorado es una característica especial de esta tendencia. Las formas curvas y elegantes le aportan un encanto especial a estas luminarias y un toque sofisticado y romántico a los ambientes.

Ⓟ Particolarmente caratteristica di questa tendenza è la combinazione di elementi di design neri e dorati. Le forme elegantemente incurvate conferiscono a questi lampadari un fascino particolare e agli spazi abitativi un tocco elegante e romantico.

Ⓠ În mod special caracteristic acestei tendințe este combinația de elemente de design în culorile negru și auriu. Aceste forme elegant curbate dau acestor piese de iluminat un farmec special și spațiilor de locuit o atingere romantică și stilată.

Ⓜ Erityisen luonteenomaista tälle trendille on mustan ja kullanväristen elementtien yhdistely. Elegantisti kaartuvat muodot antavat valaisimille erityistä viehätysvoimaa ja asuinympäristöille tyylikkään, romanttisen silauksen.

Ⓜ Szczególnie charakterystyczne dla tego trendu jest połączenie elementów designu w kolorze czarnym i złotym. Elegancko zakrzywione kształty nadają tym oprawom szczególnego uroku, a przestrzeniom mieszkalnym stylowy i romantyczny akcent.

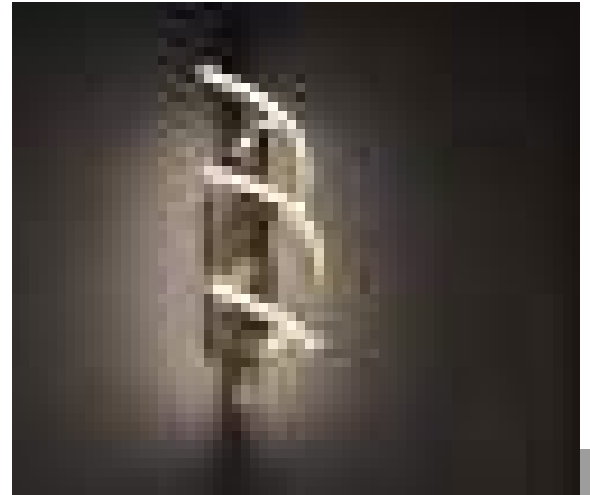

TREND HIGHLIGHTS 2022 / 2023



TRAY
Seite / page 136

- Ⓒ Ein Stil, der auf Einfachheit und Klarheit beruht. Der Minimalismus zeigt sich vor allem in einer reduzierten Farb- und Formensprache. Das Design ist geradlinig und zeitlos, auf Verspieltes wird bewusst verzichtet. Perfekte Voraussetzungen für ein dezentes und ausdrucksstarkes Ambiente.
- Ⓖ A style based on simplicity and clarity. Minimalism is reflected above all in a reduced language of colour and form. The design is straightforward and timeless, and playfulness is deliberately avoided. Perfect conditions for a discreet and expressive ambience.
- Ⓕ Un style basé sur la simplicité et la clarté. Le minimalisme est surtout reflété dans un langage réduit de couleur et de forme. Le design est simple et intemporel, et le côté ludique est délibérément omis. Des conditions parfaites pour une ambiance discrète et expressive.
- Ⓖ Een stijl gebaseerd op eenvoud en helderheid. Minimalisme wordt vooral weergegeven in een omgezette taal van kleur en vorm. Het design is ongecompliceerd en tijdloos en speelsheid wordt doelbewust vermeden. Perfecte voorwaarden voor een discrete en expressieve sfeer.
- Ⓖ Un estilo basado en la simplicidad y la claridad. El minimalismo se refleja sobre todo en la reducción del lenguaje del color y la forma. El diseño es directo y atemporal, y se evita deliberadamente el carácter lúdico. Las condiciones son perfectas para un ambiente discreto y expresivo.

① Uno stile basato sulla semplicità e sulla chiarezza. Il minimalismo si riflette soprattutto in un linguaggio ridotto di colori e forme. Il design è diretto e senza tempo, e la giocosità è deliberatamente evitata. Condizioni perfette per un ambiente discreto ed espressivo.

② Un stil bazat pe simplitate și claritate. Minimalismul este reflectat mai presus de toate printr-un limbaj redus de culoare și formă. Designul este direct și atemporal, iar spontaneitatea este deliberat evitată. Condiții perfecte pentru o ambianță discretă și expresivă.

③ Yksinkertaisuudelle ja selkeydelle pohjaava tyyli. Minimalismi äy ennenkaikkea pelkistetyssä väir- ja muotomaailmassa. Design on suoraviivainen ja ajaton, leikkisyyttä on tarkoituksella vältetty. Täydelliset olosuhteet hillittyyn ja vaikuttavaan ilmapiiriin.

④ Styl oparty na prostocie i przejrzystości. Minimalizm odzwierciedla się przede wszystkim w zredukowanym języku koloru i formy. Projekt jest prosty i ponadczasowy, celowo unika się zabawy. Idealne warunki, aby stworzyć dyskretną i wyrazistą atmosferę.

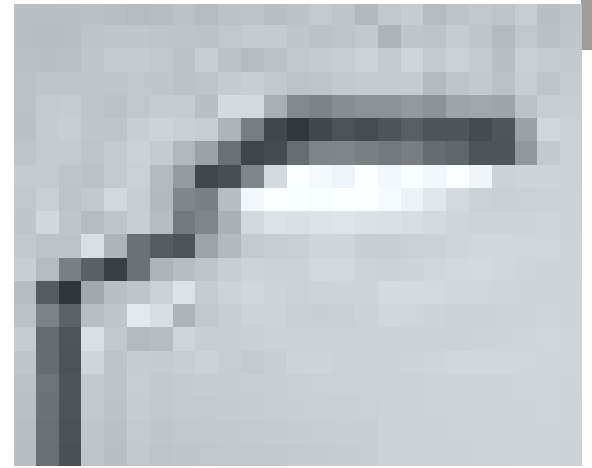

PAVIA
Seite / page 454

TREND HIGHLIGHTS 2022 / 2023

34

Ⓣ Der moderne Stil ist schlicht, cool und zeitlos. Leuchten-Designs mit kunstvollen Gläsern, setzen wirkungsvolle Statements. Die rauchfarbene Transparenz lässt das Licht zu etwas ganz Besonderem werden, und verbindet moderne Leichtigkeit mit elegantem Chic.

Ⓣ The modern style is simple, cool and timeless. Luminaire designs with artistic glass make effective statements. The smoke-coloured transparency turns the light into something very special and combines modern lightness with elegant chic.

Ⓣ Le style moderne est simple, cool et intemporel. Les designs des luminaires en verre artistique font leurs effets. La transparence fumée transforme la lumière en un quelque chose de très spécial et combine clarté moderne et chic élégant.



Ⓣ De moderne stijl is eenvoudig, cool en tijdloos. Verlichtings-
toestelontwerpen met artistiek glas zorgen voor indrukwekkende
uitdrukkingen. De blauwgrijze transparantie vormt het
licht om tot iets zeer bijzonder en combineert moderne hel-
derheid met elegant chic.

Ⓣ El estilo moderno es simple, relajado y atemporal. Los dis-
eños de luminarias con vidrios artísticos son una expresión
eficaz. La transparencia de humo coloreado convierte a la
luz en algo muy especial y combina la luminosidad moderna
con la tendencia elegante.

cool modern

Ⓜ Lo stile moderno è semplice, fresco e senza tempo. I design delle lampade con vetro artistico producono affermazioni efficaci. La trasparenza color fumo trasforma la luce in qualcosa di molto speciale e combina la leggerezza moderna con l'eleganza chic.

Ⓜ Stilul modern este simplu, cool și neafectat de trecerea timpului. Designul corpurilor de iluminat cu sticlă artistică transmite mesaje eficiente. Transparența în nuanțe fumurii transformă lumina în ceva foarte special și combină ușurința modernă cu eleganța șic.

Ⓜ Moderni tyyli on yksinkertainen, viileä ja ajaton. Taiteellisia lasidesigneja kantavat valaisimet välittävät sanoman tehokkaasti. Savunomainen läpinäkyvyys muuntaa valon erityislaatuiseksi ja yhdistää modernia keveyttä eleganttiin chiciin.

Ⓜ Nowoczesny styl jest prosty, fajny i ponadczasowy. Projekty opraw ze szkłem artystycznym tworzą efektowną ekspresję. Przezroczystość w kolorze dymu zmienia światło w coś wyjątkowego i łączy nowoczesną lekkość z eleganckim stylem.



TREND HIGHLIGHTS 2022 / 2023



36

KERALA
Seite / page 100



Ⓧ Beim Landhausstil steht die Gemütlichkeit im Mittelpunkt. Daher ist Holz das dominierende Material dieses beliebten Looks. Leuchten aus Massivholz, in Kombination mit modernen Design-Elementen, bieten reichlich Inspiration für neue Ideen und geben dieser traditionellen Stilrichtung einen zeitgemäßen Kick.

Ⓟ The country house style focuses on cosiness. Therefore, wood is the dominant material of this popular look. Luminaires made of solid wood, combined with modern design elements, offer plenty of inspiration for new ideas and give this traditional style a contemporary kick.

Ⓡ Le style maison de campagne se concentre sur le confort. Par conséquent, le bois est le matériau dominant de ce look à la mode. Les luminaires fabriqués en bois solide, combinés à des éléments décoratifs modernes, offrent beaucoup d'inspiration pour de nouvelles idées et apportent à ce style traditionnel une touche contemporaine.

Ⓝ De landhuisstijl focust op gezelligheid. Bijgevolg is hout het dominante materiaal van deze populaire look. Verlichtingstoestellen gemaakt uit stevig hout, gecombineerd met moderne designelementen, bieden veel inspiratie voor nieuwe ideeën en bieden deze traditionele stijl een hedendaagse stimulans.

modern cottage

ES El estilo de las casas de campo se centra en el carácter acogedor. Por lo tanto, la madera es el material que predomina en este popular estilo. Las luminarias hechas de madera maciza, combinadas con elementos de diseño modernos, ofrecen mucha inspiración para nuevas ideas y le brindan a este estilo tradicional un golpe contemporáneo.

IT Lo stile della casa di campagna si concentra sull'intimità. Pertanto, il legno è il materiale dominante di questo look popolare. Le lampade in legno massiccio, abbinate a elementi di design moderno, offrono numerosi spunti per nuove idee e conferiscono a questo stile tradizionale un tocco di contemporaneità.

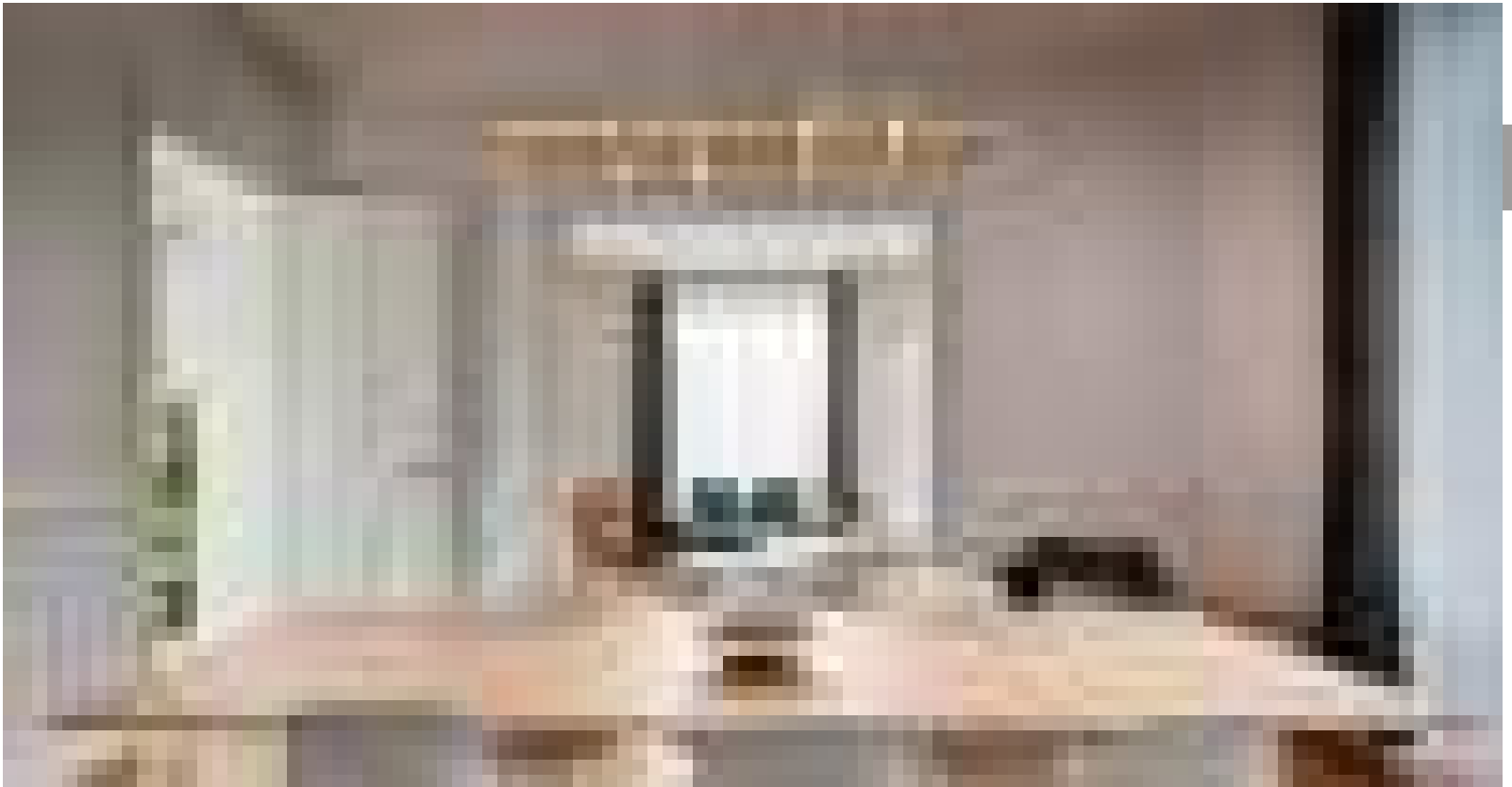

37

RO Stilul rustic se concentrează pe confort. Drept urmare, lemnul este materialul preponderent în acest aspect popular. Corpuri de iluminat făcute din lemn masiv, combinate cu elemente moderne de design, oferă multă inspirație pentru idei noi și îi dau acestui stil tradițional un impuls contemporan.

FI Maalaistyyli keskittyy mukavuuteen. Siksi puu on tämän suosittun tyylin hallitseva materiaali. Täyspuusta valmistetut valaisimet yhdistettyinä moderneihin design-elementteihin tarjoavat runsaasti inspiraatiota uusille ideoille ja antavat perinteiselle tyyliille nykyaikaisen silauksen.

PL Styl wiejskiego domu stawia na przytulność. Dlatego drewno jest dominującym materiałem tego popularnego designu. Oprawy wykonane z litego drewna w połączeniu z nowoczesnymi elementami dają mnóstwo inspiracji dla nowych pomysłów i nadają współczesnego akcentu temu tradycyjnemu stylowi.

TREND HIGHLIGHTS 2022 / 2023

Ⓓ Der industrielle Wohnstil ist roh und rustikal. Metall, Stein und unverputzte Ziegelwände zeichnen ihn aus. Leuchten im Vintage-Look schaffen einen lässigen Loft-Charakter, und verleihen dem kühlen Industrie-Style Wohnlichkeit.

Ⓔ The industrial style of living is raw and rustic. Metal, stone and unplastered brick walls characterise it. Vintage-look luminaires create a casual loft character, and lend cosiness to the cool industrial style.

Ⓕ Le style de vie industriel est brut et rustique. Il est caractérisé par le métal, la pierre et les murs en briques apparentes. Les luminaires au look vintage créent un caractère loft décontracté et confèrent de l'intimité au style industriel froid.



Ⓖ De industriële stijl van leven is ruw en rustiek. Metaal, steen en niet-bepaalde bakstenen muren typeren dit. Verlichtingstoestellen met vintage-look creëren een nonchalant loft-karakter, en verlenen gezelligheid aan de koele industriële stijl.

Ⓖ El estilo industrial es crudo y rústico. Lo caracterizan las paredes de metal, piedra y ladrillo a la vista. Las luminarias de aspecto antiguo crean un carácter casual para los ambientes de pocas divisiones y le aportan calidez al frío estilo industrial.



industrial

① Lo stile abitativo industriale è grezzo e rustico. Metallo, pietra e pareti di mattoni non intonacate lo caratterizzano. Le lampade dall'aspetto vintage creano un carattere informale da loft e conferiscono un'atmosfera accogliente al fresco stile industriale.

② Modul de viață industrial este brut și rustic. Îl caracterizează metalul, piatra și pereții cu cărămida expusă. Corpuri de iluminat cu aspect vintage creează un caracter informal de mansardă și oferă confort stilului rece industrial.

③ Industrial-tyylinen elämä on raakaa ja rustiikkista. Metallit, kivi ja rapaamaton tiiliseinä ovat sille luonteenomaisia. Vintage-tyyliset valaisimet luovat rentoa loft-tunnelmaa, ja tuovat kodikkuutta viileään industrial-tyyliin.



39

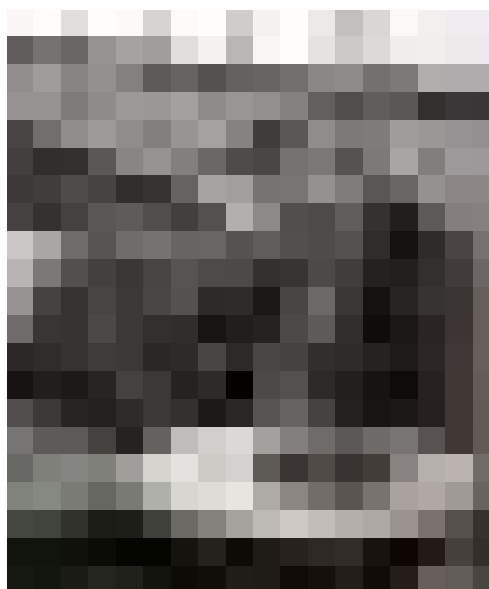
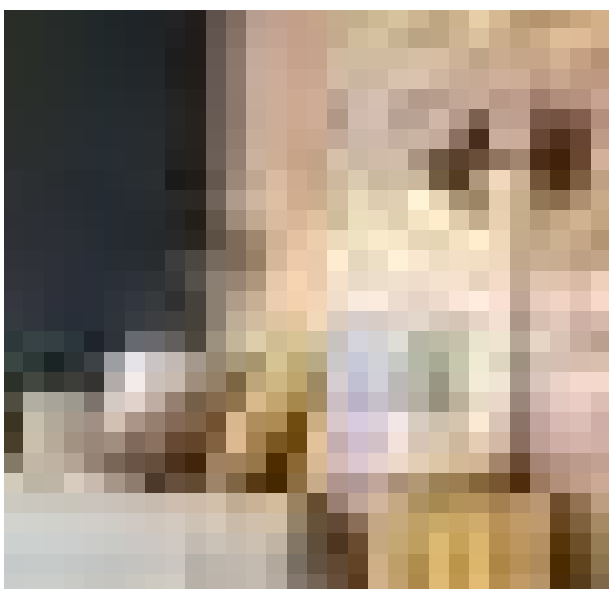

ROXIE
Seite / page 145

④ Przemysłowy styl mieszkania jest prosty i surowy. Charakteryzują go ściany z metalu, kamienia i nieotynkowanej cegły. Oprawy w klasycznym stylu oddają swobodny charakter poddasza i nadają przytulności chłodnym, industrialnym wnętrzom.

TREND HIGHLIGHTS 2022 / 2023



RUNA
Seite / page 285

Ⓝ Deze huidige leefftrend is vooral gericht op trendbewuste natuurliefhebbers. Materialen zoals hout, vlechtwerk of sisalvezel creëren een natuurlijke, exotische sfeer en brengen een sfeer over van vrijheid en avontuur.

Ⓞ La tendencia actual se enfoca sobre todo en los amantes de la naturaleza. Los materiales como la madera, el mimbre o el sisal crean un ambiente natural y exótico. Además, transmiten un entorno de libertad y aventura.

Ⓝ Dieser aktuelle Wohntrend richtet sich vor allem an trendbewusste Naturliebhaber*innen. Materialien wie Holz, Korbgeflecht oder Sisal sorgen für ein naturnahes, exotisches Ambiente und vermitteln eine Atmosphäre von Freiheit und Abenteuer.

Ⓞ This current living trend is aimed primarily at trend-conscious nature lovers. Materials such as wood, wickerwork or sisal create a natural, exotic ambience and convey an atmosphere of freedom and adventure.

Ⓞ Cette tendance actuelle d'éclairage est principalement destinée aux amoureux de la nature soucieux de la tendance. Les matériaux comme le bois, la vannerie ou le sisal créent une ambiance naturelle et exotique et apporte une atmosphère de liberté et d'aventure.



PLANT
Seite / page 271

urban jungle

Ⓜ Questa tendenza abitativa attuale si rivolge soprattutto agli amanti della natura attenti alle tendenze. Materiali come legno, vimini o sisal creano un ambiente naturale ed esotico e trasmettono un'atmosfera di libertà e avventura.

Ⓜ Această curentă tendință de trai îi vizează în principal pe iubitorii de natură care urmăresc tendințele. Materiale precum lemnul, ratan sau sisal creează o atmosferă de libertate și aventură.



INGA
Seite / page 280

41

Ⓜ Tämänhetkinen asumistrendi on suunnattu pääasiassa trenditietoisille luonnostäville. Materiaalit, kuten puu, rottinki tai sisali, luovat luonnollisen, eksoottisen ilmapiirin ja henkivät vapautta ja seikkailuntuntua.

Ⓜ Ten aktualny trend mieszkaniowy jest skierowany przede wszystkim do miłośników przyrody. Materiały takie jak drewno, wiklina czy sisal tworzą naturalną, egzotyczną atmosferę i oddają atmosferę wolności i przygody.



TREND HIGHLIGHTS 2022 / 2023



Smart Home-Beleuchtung erfreut sich zunehmend, steigender Beliebtheit. Intelligente Lichtsteuerung bietet nicht nur ein Höchstmaß an Komfort und Flexibilität, sie eröffnet auch völlig neue Möglichkeiten der kreativen Lichtgestaltung. Auf diese Weise lassen sich Lebensqualität, Wohnkomfort und Sicherheit auf ein neues Level bringen.

Smart home lighting is becoming increasingly popular. Intelligent lighting control not only offers maximum convenience and flexibility, it also opens up completely new possibilities for creative lighting design. In this way, quality of life, living comfort and safety can be brought to a new level.

L'éclairage intelligent des maisons devient de plus en plus à la mode. Le contrôle de l'éclairage intelligent offre non seulement un grand confort et une flexibilité maximale, mais ouvrent également de nouvelles possibilités pour une conception d'éclairage créatif. De cette façon, la qualité de vie, le confort de vie et la sécurité peuvent être hissés à un tout autre niveau.

Slimme thuisverlichting wordt meer en meer populair. Intelligente verlichtingsregeling biedt niet enkel maximaal gemak en maximale flexibiliteit, het opent ook volledig nieuwe mogelijkheden voor een creatief verlichtingsdesign. Op deze manier kunnen levenskwaliteit, leefcomfort en veiligheid tot een nieuw niveau gebracht worden.



smart lighting

Ⓔ La iluminación de casas inteligentes se está volviendo cada vez más popular. El control inteligente de la iluminación no sólo ofrece la máxima comodidad y flexibilidad, sino que también da lugar a posibilidades completamente nuevas para el diseño creativo de la iluminación. De esta manera, la calidad de vida, comodidad y seguridad para vivir pueden alcanzar un nuevo nivel.

Ⓙ L'illuminazione domestica smart sta diventando sempre più popolare. Il controllo intelligente dell'illuminazione non solo offre la massima comodità e flessibilità, ma apre anche nuove possibilità di progettazione creativa. In questo modo, la qualità della vita, il comfort abitativo e la sicurezza possono essere portati a un nuovo livello.

Ⓚ Iluminatul inteligent al locuințelor devine din ce în ce mai popular. Controlul iluminatului inteligent nu numai că oferă maximul de ușurință și flexibilitate, dar de asemenea deschide noi posibilități pentru designul creativ al iluminatului. În acest fel, calitatea vieții, confortul de trai și siguranța pot fi ridicate la un nou nivel.

Get your light connected.



64.000 **WEISSTÖNE**
64,000 **WHITES**



Einstellbare Lichtprogramme · Preset light modes



16 Millionen **FARBEN**
16 million **COLORS**



Dynamische Lichtprogramme · Dynamic light modes

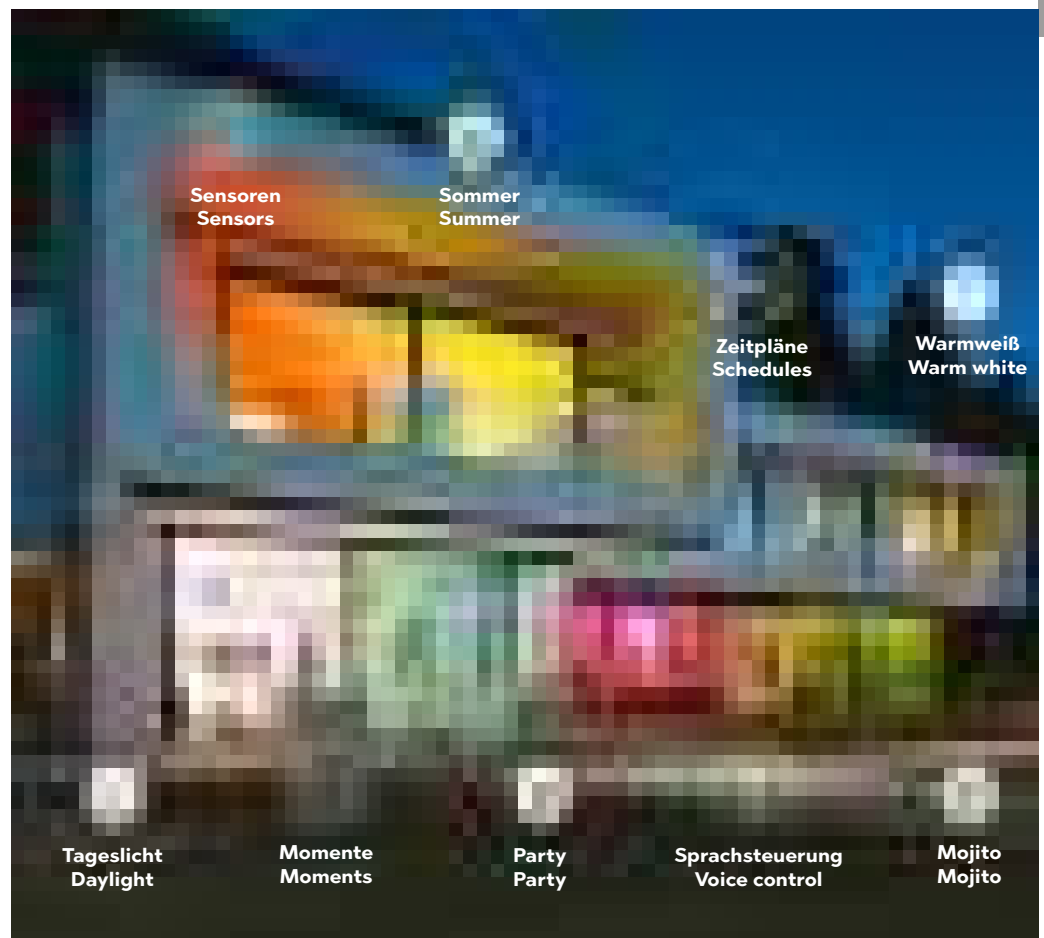

Ⓛ Kotien älyvalaistuksesta on tulossa yhä suosituempaa. Älykäs valonsäätely tarjoaa maksimaalista käytännöllisyyttä ja joustavuutta, sekä avaa täysin uusia mahdollisuuksia luovalle valaistussuunnittelulle. Tällä tavoin elämänlaatu, asuinmukavuus ja turvallisuus voidaan viedä uudelle tasolle.

Ⓜ Inteligentne oświetlenie w domu staje się coraz bardziej popularne. Inteligentne sterowanie oświetleniem oferuje nie tylko maksymalną wygodę i elastyczność, ale także otwiera zupełnie nowe możliwości kreatywnego projektowania oświetlenia. W ten sposób jakość życia, komfort i bezpieczeństwo można przenieść na



trio-lighting.com/wiz



Mehrere Standorte

Kontrollieren und Steuern von mehreren Standorten gleichzeitig und von überall aus. Ob das eigene Zuhause oder die Ferienwohnung.

Multiple locations

Control and command multiple locations simultaneously and from anywhere. Whether your own home or your holiday home.

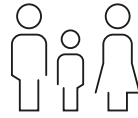

Mehrere Nutzer

Die Anzahl der Nutzer zur Steuerung der Leuchten kann individuell festgelegt werden.

Multiple user

The number of persons to control the lights can be set individually.



Cloud basiert

WiZ verbindet sich mit der Cloud, damit Vorlieben gespeichert, Wünsche geteilt und Updates automatisch generiert werden.

Cloud based

WiZ connects to the cloud to store preferences, share desires and generate updates automatically.

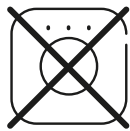

Keine zusätzliche Bridge erforderlich

Es wird keine zusätzliche Bridge oder Hub für die Steuerung der Leuchten benötigt.

No additional hub needed

There is no need for an additional bridge or hub to control the lights.



Mehrere Räume

Alle Leuchten können unterschiedlichen Räumen zugeordnet und präzise gesteuert werden – einzeln oder in Gruppen.

Several rooms

All lights can be assigned to different rooms and precisely controlled – individually or in groups.



Wlan Technologie

WiZ nutzt WLAN-Technologie als sichere, unabhängige, kostengünstige und einfach zu installierende Funklösung.

WiFi technology

WiZ uses Wi-Fi technology as a secure, independent, affordable and easy-to-install wireless solution.

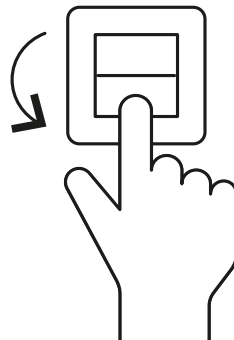

WiZ

CLICK

Einfach und effektiv. Zwei bevorzugte Lichtmodi können über den vorhandenen Lichtschalter bedient werden.

Simple and effective. Two preferred light modes can be operated via the existing light switch.

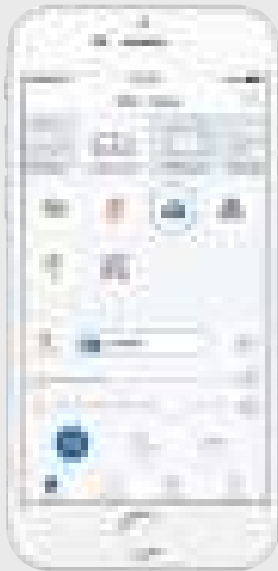

WiZ APP

Einfach und schnell installiert.
Volle Funktionalität und Flexibilität mit der
WiZ App – erhältlich im App Store oder bei
Google Play.

Easy and quick to install. Full functionality
and flexibility with the WiZ App – available
on the App Store or on Google Play.



WiZ MOTE

Steuerung über die
Fernbedienung und
Abspeichern von
vier favorisierten
Lichtmodi möglich.

Control via the
remote control and
possibility to save
four favorite light
modes.



WiZ MAGIC

Steuerung der Leuchten über Zeitpläne,
Sensoren oder einfache Sprachbefehle.
Kompatibel mit Amazon Alexa
und Google Home.

Control of the lights by time schedules, with
sensors or by simple verbal commands.
Compatible with Amazon Alexa
and Google Home.

DIMMEN DIMMING



64.000 **WEISSTÖNE**
64,000 **WHITES**

Einstellbare Lichtprogramme · Preset light modes



16 Millionen **FARBEN**
16 million **COLORS**

Dynamische Lichtprogramme · Dynamic light modes



30 Sekunden zur Installation · **30** seconds to install



Die Lampe installieren

Install a lamp



Wählen Sie den „Koppeln“ Modus

Start pairing



3 x EIN / AUS

3 x ON/OFF



Die Lampe beginnt „blau“ zu blinken
und schaltet danach auf weiß

Light turns blue then goes white



Die Einstellungen sind nun gespeichert,
jeder kann zu Hause WiZ nutzen.

The settings are now saved!
Now everyone can use WiZ at your home.

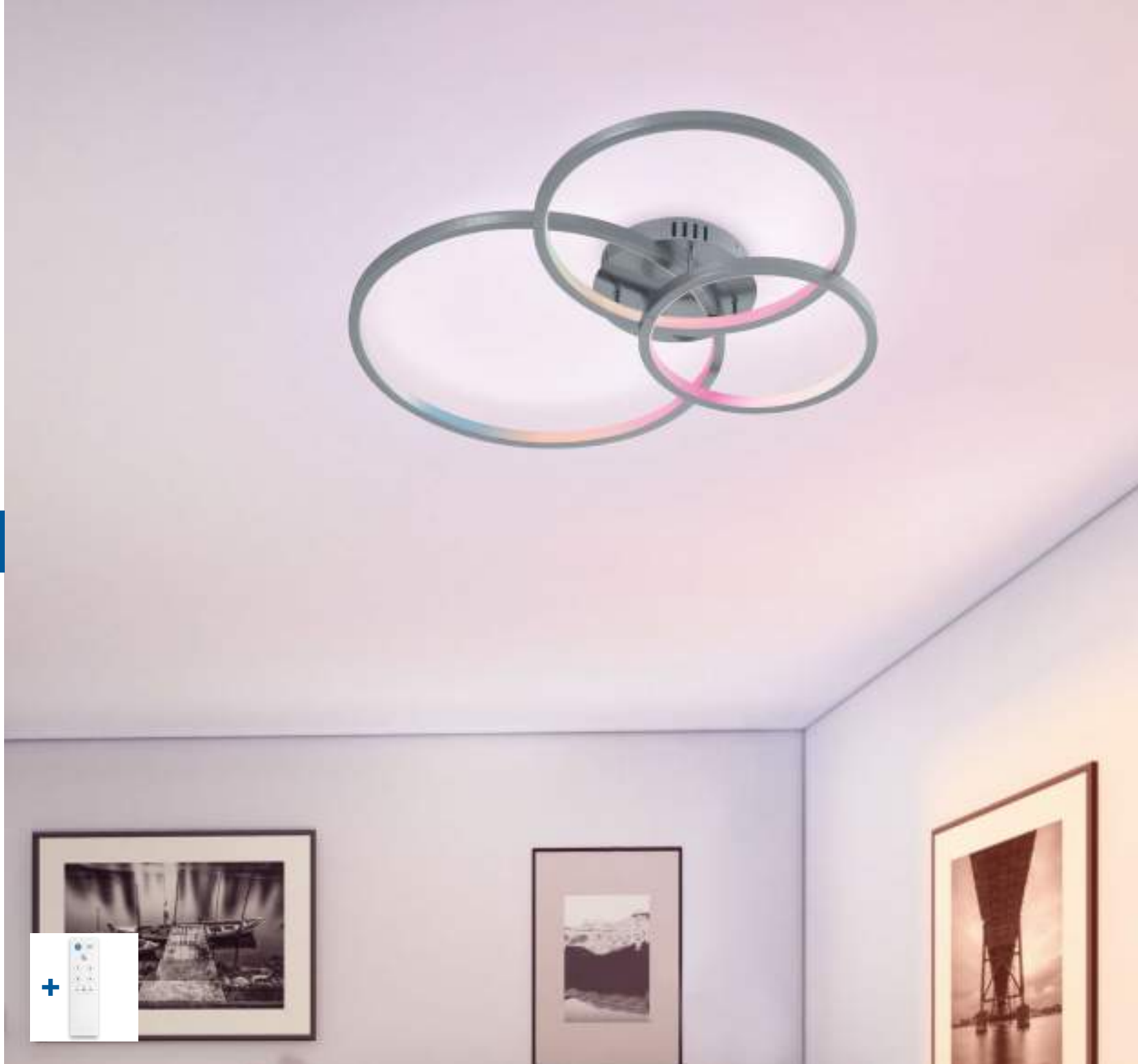

Deckenleuchte · Ceiling lamp
↔ 79 x 64 cm, ↑ 10,5 cm
incl. RGBW-LED, 36,5 W
4.200 lm, 3.000 - 6.000 K



652710307
652710342



AARON

Metall, Nickel matt oder Anthrazit · metal, nickel mat or anthracite ·
 metale, nickel mat ou antracite · metaal, nikkell mat of antraciet ·
 metal, níquel mate o antracita · metallo, nichel opaco o antracite ·
 metal, nichel mat sau antracit · metalli, harjattu teräs tai antrasiitti ·
 metal, nikiel mat lub antracyt

SMART LIGHTING



07 | Nickel matt · nickel mat



42 | Anthrazit · anthracite



Pendelleuchte · Pendant

Ø 80 cm, ↓ 150 cm

incl. RGBW-LED, 78 W

9.200 lm, 3.000 - 6.000 K



352710307

352710342

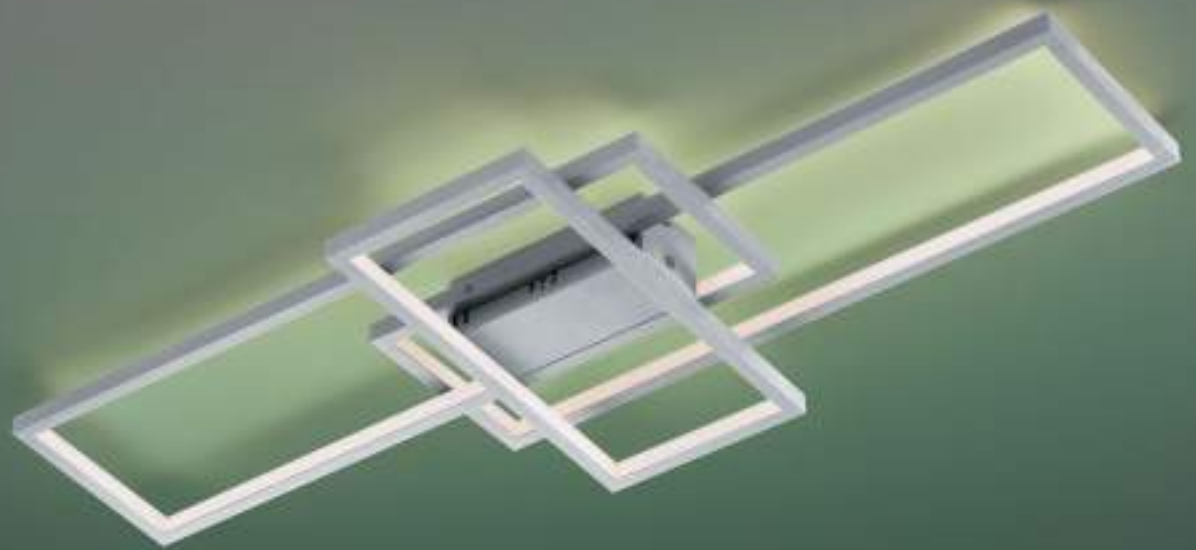
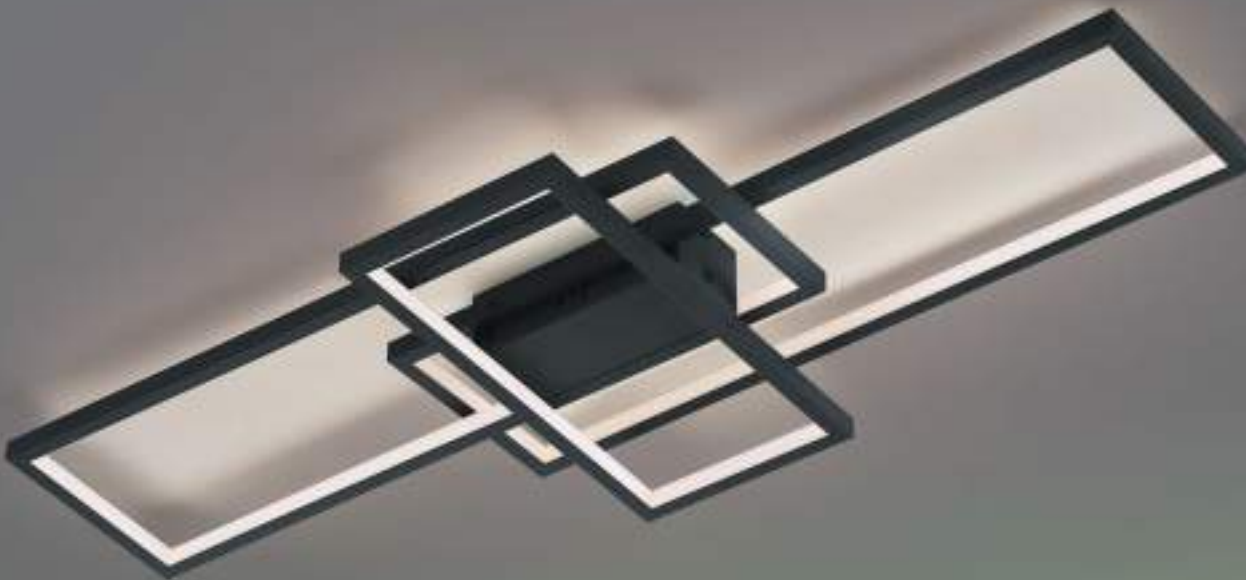

THIAGO

Metall, Nickel matt oder Anthrazit · metal, nickel mat or anthracite ·
metale, nickel mat ou antracite · metaal, nikkell mat of antraciet ·
metal, níquel mate o antracita · metallo, nichel opaco o antracite ·
metal, nichel mat sau antracit · metalli, harjattu teräs tai antrasiitti ·
metal, nikiel mat lub antracyt

SMART LIGHTING

07 | Nickel matt · nickel mat

32 | Schwarz matt · black mat

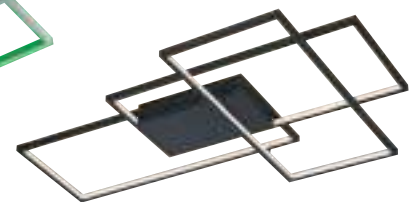
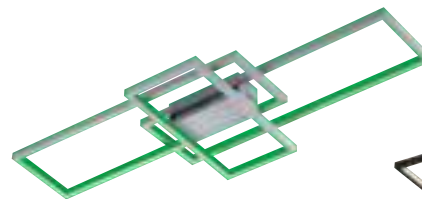

Deckenleuchte · Ceiling lamp

↔ 104 x 42 cm, ↑ 8,5 cm
incl. RGBW-LED, 36 W
3.000 lm, 3.000 - 6.000 K



652610307
652610342

Deckenleuchte · Ceiling lamp

↔ 114 x 75 cm, ↑ 8,5 cm
incl. RGBW-LED, 39 W
4.500 lm, 3.000 - 6.000 K



652690307
652690342





CITIZEN

Metall, Nickel matt oder Schwarz matt · metal, nickel mat or black mat ·
 metale, nickel mat ou noir mat · metaal, nikkel mat of mat zwart ·
 metal, níquel mate o estera negra · metallo, nichel opaco o nero opaco ·
 metal, nichel mat sau negru mat · metalli, harjattu teräs tai mattamusta ·
 metal, nikiel mat lub czarny mat

SMART LIGHTING



Deckenleuchte · Ceiling lamp
 ↔ 94,5 x 55 cm, ↓ 8 cm
 incl. 2 x RGBW-LED, 17 W
 max. 2 x 1.900 lm, 3.000 - 5.000 K



651110207
 651110232



07 | Nickel matt · nickel mat



32 | Schwarz matt · black mat



MELBY

Nickel matt, Acryl · nickel mat, acryl ·
 nickel mat, acryl · nikkel mat, acryl · níquel mate, acrílico ·
 nichel opaco, acrílico · nichel mat, acrylic · harjattu teräs, akryyli ·
 nikiel mat, akryl

Direkte und indirekte Beleuchtung · up and down lighting ·
 point lumineux en haut et en bas · lichtpunt boven en onder ·
 luz de arriba y abajo · luce su e giù · sus și în jos lumina ·
 ylös ja alas valoa · w górę iw dół światło

SMART LIGHTING

Deckenleuchte · Ceiling lamp
 ↔ max. 242 x 10 cm, ↑ 12 cm
 incl. RGBW-LED, 23 W
 max. 2.200 lm, 3.000 - 5.000 K



651210507



Deckenleuchte · Ceiling lamp
 Ø 30 cm, ↑ 5 cm
 incl. SMD-LED, 15 W
 1.750 lm, 3.000 - 5.500 K



657493007



Deckenleuchte · Ceiling lamp
 Ø 40 cm, ↑ 5 cm
 incl. SMD-LED, 20 W
 2.000 lm, 3.000 - 5.500 K



657494007



Deckenleuchte · Ceiling lamp
 Ø 60 cm, ↑ 5 cm
 incl. SMD-LED, 37 W
 4.200 lm, 3.000 - 5.500 K



657496007



Deckenleuchte · Ceiling lamp
 ↔ 29,5 x 29,5 cm, ↑ 5 cm
 incl. SMD-LED, 15 W
 1.750 lm, 3.000 - 5.500 K



657413007

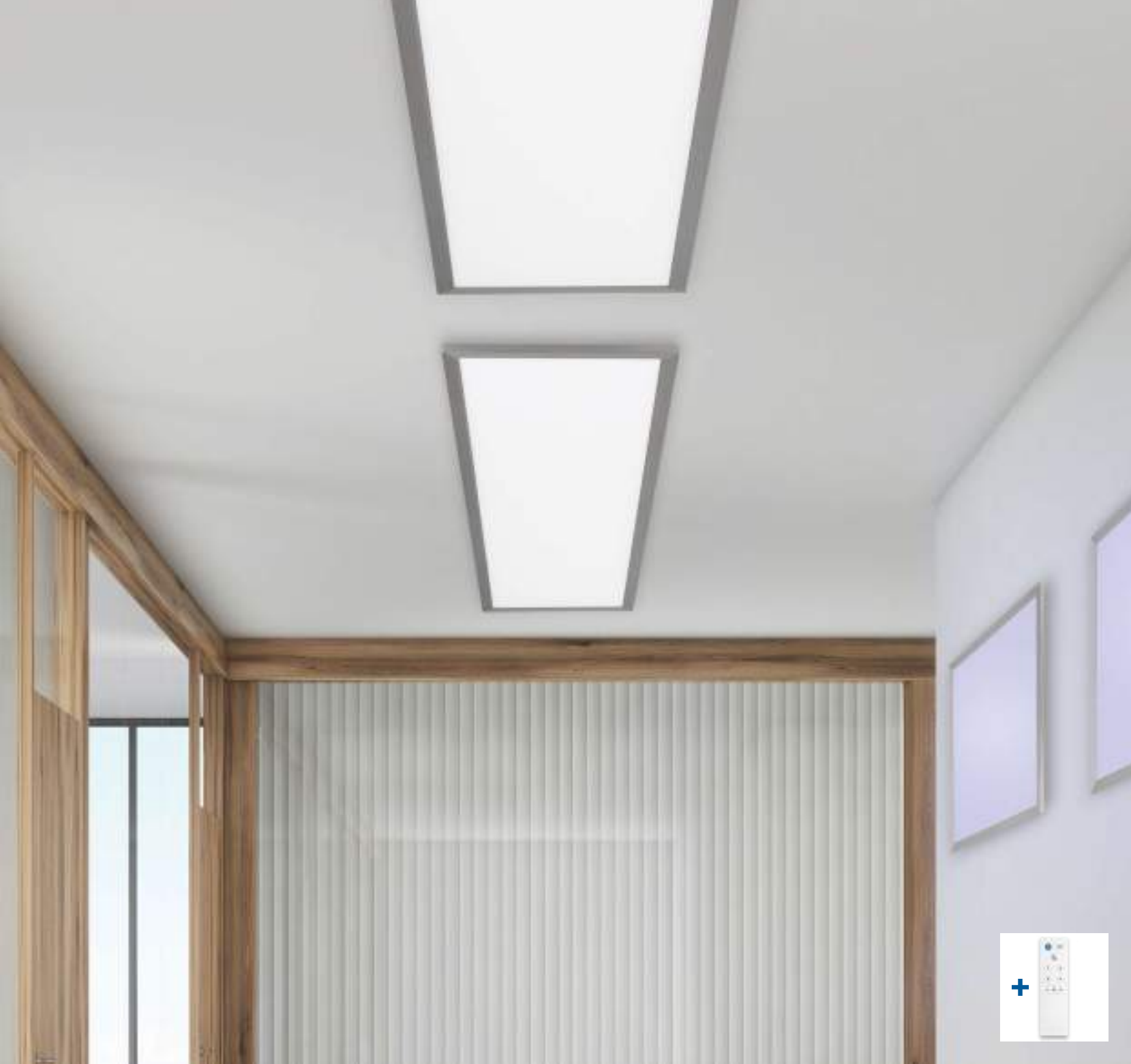

GRIFFIN

Nickel matt, Acryl · nickel mat, acryl ·
 nickel mat, acryl · nikkel mat, acryl · níquel mate, acrílico · nichel opaco, acrilico ·
 nichel mat, acrilic harjattu teräs, akryyli · nikiel mat, akryl

SMART LIGHTING



Deckenleuchte · Ceiling lamp
 ↔ 39,5 x 39,5 cm, ↓ 5 cm
 incl. SMD-LED, 20 W
 2.300 lm, 3.000 - 5.500 K



657414007



Deckenleuchte · Ceiling lamp
 ↔ 59,5 x 59,5 cm, ↓ 5 cm
 incl. SMD-LED, 36 W
 4.200 lm, 3.000 - 5.500 K



657416007



Deckenleuchte · Ceiling lamp
 ↔ 109,5 x 29,5 cm, ↓ 5 cm
 incl. SMD-LED, 37 W
 4.300 lm, 3.000 - 5.500 K



657411107



DIAMO

Stoff weiß · fabric white ·
tissu blanc · textiel wit · tela blanco · tessuto bianco ·
textil alb · tekstiili valkoinen · tkanina biały

SMART LIGHTING



Deckenleuchte · Ceiling lamp
Ø 60 cm, ↑ 10 cm
incl. RGBW-LED, 36 W
max. 3.400 lm, 3.000 - 5.000 K

Deckenleuchte · Ceiling lamp
Ø 75 cm, ↑ 10 cm
incl. 1 x RGBW-LED, 47 W
max. 5.500 lm, 3.000 - 5.000 K



651914001

651915501



CHARLY

Acryl, weiß · acryl, white ·
acryl, blanc · acryl, wit · acrílico, blanco · acrilico, bianco ·
acrilic, alb · akryyli, valkoinen · akryl, biały

Deckenleuchte · Ceiling lamp

Ø 50 cm, ↑ 12 cm

incl. RGBW-LED, 27 W

max. 3.100 lm, 3.000 - 5.500 K



656010100



SMART LIGHTING

NALIDA

Acryl, weiß · acryl, white ·
acryl, blanc · acryl, wit · acrílico, blanco · acrilico, bianco ·
acrilic, alb · akryyli, valkoinen · akryl, biały

Deckenleuchte · Ceiling lamp

Ø 74 cm, ↑ 10 cm

incl. RGBW-LED, 40 W

max. 4.650 lm, 3.000 - 5.500 K



656090100





PANTILON

Acryl, weiß · acryl, white ·
 acryl, blanc · acryl, wit · acrílico, blanco ·
 acrilico, bianco · acrilic, alb · akryyli, valkoinen ·
 akryl, biały

**SMART
 LIGHTING**

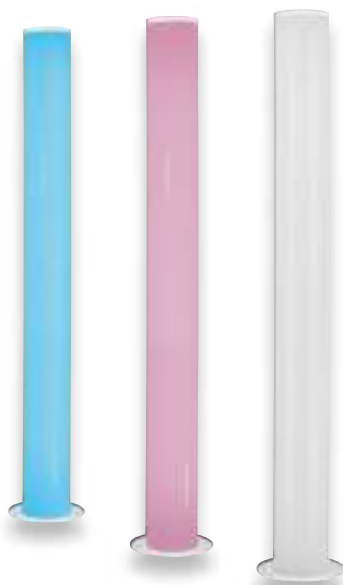

Stehleuchte · Floor lamp

↑ 150 cm, Ø 24 cm

incl. SMD-LED, 22 W

2.200 lm, 3.000 - 6.000 K



451850101

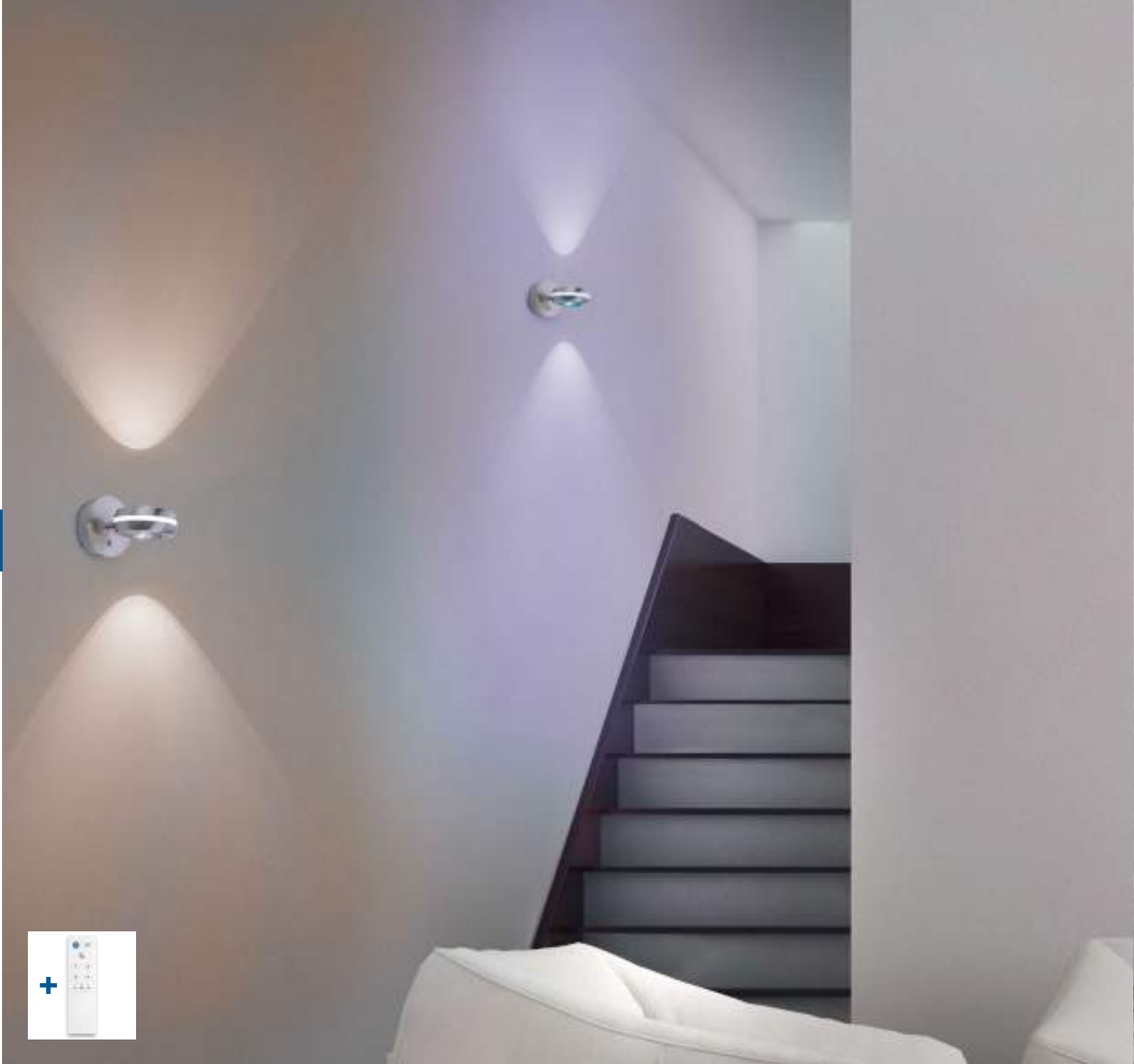

VISTA

Nickel matt · nickel mat ·
 nickel mat · nikkell mat · níquel mate ·
 nichel opaco · nichel mat · harjattu teräs · nikiel mat

SMART LIGHTING

Wandleuchte · Wall lamp
 Ø 11 cm, ʘ 17,5 cm
 incl. 2 x RGBW-LED, 3,8 W
 2 x 380 lm, 3.000 - 5.000 K



255410207





FIGO

Metall · metal ·
metale · metaal · metal · metallo · metal · metalli · metal

SMART LIGHTING

Wandleuchte · Wall lamp

↔ 10 x 10 cm, √ 10 cm
incl. RGBW-LED, 5,5 W
700 lm, 3.000 - 6.500 K



253310105
253310131
253310132



05 | Aluminium gebürstet · brushed aluminium



31 | Weiß matt · white mat



32 | Schwarz matt · black mat





Leuchtenfamilien & Kombinationen

Families & coordinates

Familles & coordonnés

Families & combinaties

Familias & coordinados

Famiglie & coordinati

Famillii & Coordonate



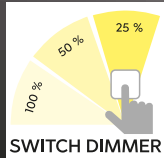

Tuoteperheet & yhdistettävät tuotteet

Rodzinne orawy & kombinacje



FRANKLIN

Metall · metal · metale · metaal · metal · metallo · metal · metalli · metal

-  **04** | Altmessing · old brass
-  **07** | Nickel matt · nickel mat
-  **08** | Messing matt · brass mat
-  **42** | Anthrazit · anthracite



Deckenleuchte · Ceiling lamp
 Ø 35 cm, ↓ 13 cm
 incl. 3 x SMD-LED, 8,5 W
 3 x 1.000 lm, 3.000 K



626510304
 626510307
 626510308
 626510342



Tischleuchte · Table lamp
 ↓ 25 cm, Ø 14 cm
 incl. SMD-LED, 6 W
 700 lm, 3.000 K



526510104
 526510107
 526510108
 526510142



Stehleuchte · Floor lamp
 ↓ 181 cm, Ø 35,2 cm, ∠ 41 cm
 incl. SMD-LED, 35 W, 4.100 lm
 incl. SMD-LED, 6,5 W, 650 lm
 2.700 + 3.200 + 4.000 K



426510204
 426510207
 426510208
 426510242





2.700 K



3.200 K



4.000 K

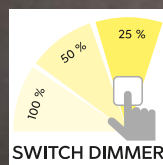

SWITCH DIMMER

**04** | Altmessing · old brass**07** | Nickel matt · nickel mat**08** | Messing matt · brass mat**42** | Anthrazit · anthracite

Stehleuchte · Floor lamp
 ↓ 133 cm, Ø 23 cm, ∇ 41 cm
 incl. SMD-LED, 6,5 W
 650 lm, 2.700 + 3.200 + 4.000 K



426510104
 426510107
 426510108
 426510142

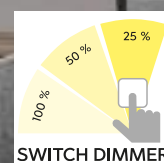

FRANKLIN

Metall · metal ·
metale · metaal · metal ·
metallo · metal · metalli · metal



Pendelleuchte · Pendant
 ↑ 95 - 180 cm, Ø 14 cm
 incl. SMD-LED, 7,2 W
 835 lm, 3.000 K



326510107
 326510108
 326510142



Pendelleuchte · Pendant
 ↑ 95 - 150 cm, ↔ 55 x 14 cm
 incl. 2 x SMD-LED, 7,2 W
 2 x 835 lm, 3.000 K



326510207
 326510208
 326510242



Pendelleuchte · Pendant
 ↑ 95 - 150 cm, ↔ 85 x 14 cm
 incl. 3 x SMD-LED, 7,2 W
 3 x 835 lm, 3.000 K



326510307
 326510308
 326510342



SEQUENCE

Metall, Messing matt, Schwarz matt · metal, brass mat, black mat ·
 métal, laiton mat, noir mat · metaal, messing mat, mat zwart ·
 metal, bronce mate, estera negra · metallo, ottone satinato, nero opaco ·
 metal, bronz mat, negru mat · metalli, mattamessinki, mattamusta ·
 metal, mosiądz mat, czarny mat



Lichtfarbe einstellbar ·
 Adjustable light color



2.300 K



3.000 K



4.000 K



Wandleuchte · Wall lamp
 ↓ 47 cm, ↔ 13,5 cm, ↗ 20,5 cm
 incl. SMD-LED, 22 W
 2.800 lm, 2.300 + 3.000 + 4.000 K



241810208

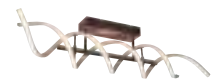

Deckenleuchte · Ceiling lamp
 ↔ 90 x 14,5 cm, ↓ 20,5 cm
 incl. SMD-LED, 41 W
 5.000 lm, 2.300 + 3.000 + 4.000 K



641810208



Pendelleuchte · Pendant
 ↓ 150 cm, ↔ 105 x 16 cm
 incl. SMD-LED, 45 W
 5.600 lm, 2.300 + 3.000 + 4.000 K



341810208



Tischleuchte · Table lamp
 ↓ 48,5 cm, Ø 16 cm
 incl. SMD-LED, 20,5 W
 2.600 lm, 2.300 + 3.000 + 4.000 K



541810208



Stehleuchte · Floor lamp
 ↓ 150 cm, Ø 23 cm
 incl. SMD-LED, 32 W
 4.000 lm, 2.300 + 3.000 + 4.000 K



441810208

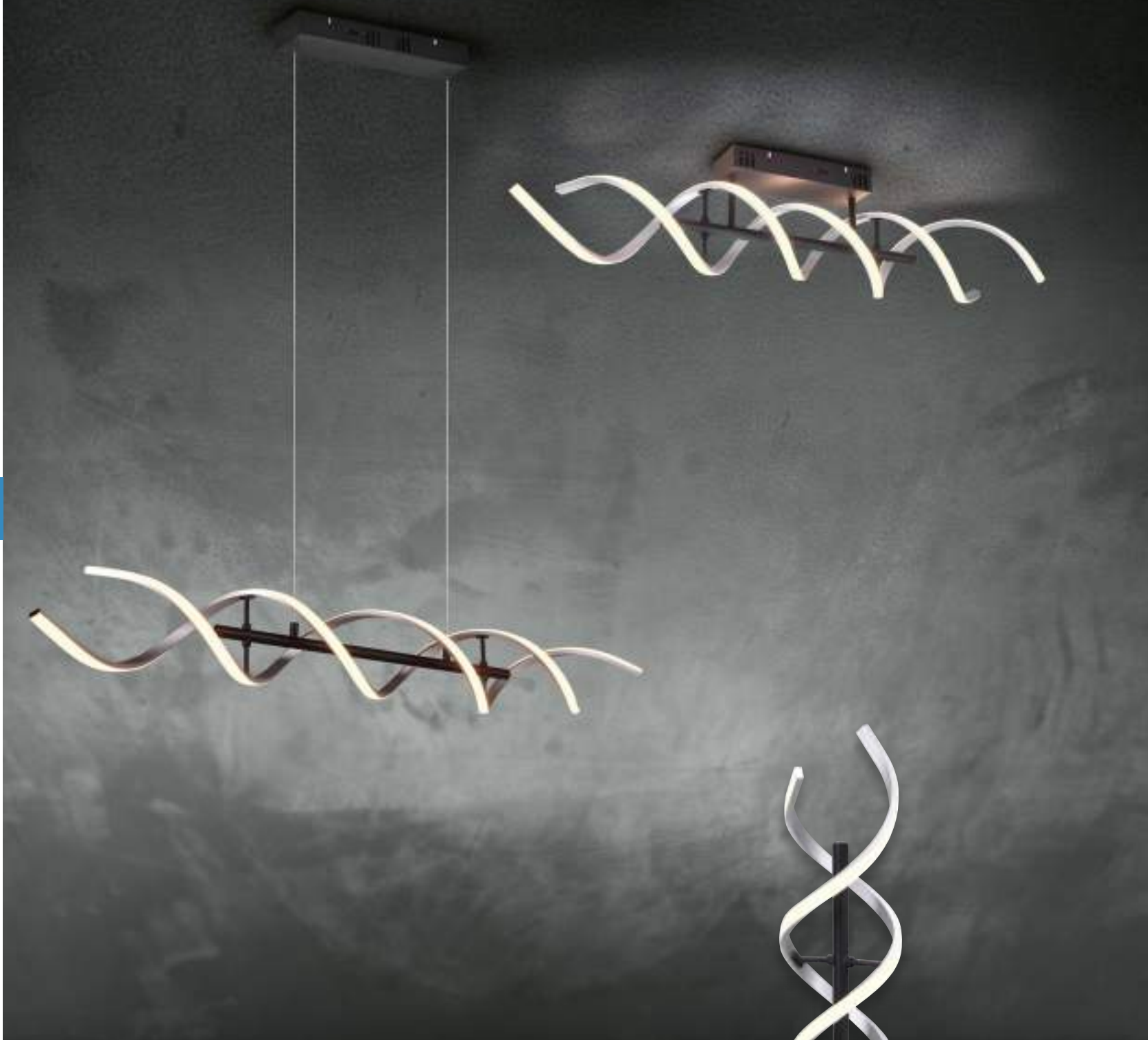

SEQUENCE

Metall, Aluminium gebürstet, Schwarz matt · metal, brushed aluminium, black mat ·
 métal, aluminium balayé, noir mat · metaal, geborsteld aluminium, mat zwart ·
 metal, aluminio pulido, estera negra · metallo, alluminio spazzolato, nero opaco ·
 metal, aluminiu lucios, negru mat · metalli, harjattu alumiini, mattamusta ·
 metal, aluminium szczotkowane, czarny mat



Lichtfarbe einstellbar ·
 Adjustable light color



2.300 K



3.000 K



4.000 K

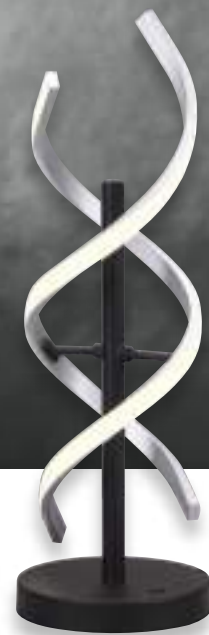

Wandleuchte · Wall lamp
 ↓ 47 cm, ↔ 13,5 cm, ↗ 20,5 cm
 incl. SMD-LED, 22 W
 2.800 lm, 2.300 + 3.000 + 4.000 K



241810205

Deckenleuchte · Ceiling lamp
 ↔ 90 x 14,5 cm, ↓ 20,5 cm
 incl. SMD-LED, 41 W
 5.000 lm, 2.300 + 3.000 + 4.000 K



641810205



Pendelleuchte · Pendant
 ↑ 150 cm, ↔ 105 x 16 cm
 incl. SMD-LED, 45 W
 5.600 lm, 2.300 + 3.000 + 4.000 K



341810205



Tischleuchte · Table lamp
 ↑ 48,5 cm, Ø 16 cm
 incl. SMD-LED, 20,5 W
 2.600 lm, 2.300 + 3.000 + 4.000 K



541810205



Stehleuchte · Floor lamp
 ↑ 150 cm, Ø 23 cm
 incl. SMD-LED, 32 W
 4.000 lm, 2.300 + 3.000 + 4.000 K



441810205

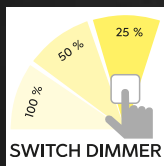

Pendelleuchte · Pendant
 Ø 62 cm, ↑ 150 cm
 incl. SMD-LED, 42 W
 5.600 lm, 3.000 K



321210107
321210108



Deckenleuchte · Ceiling lamp
 Ø 41 cm, ↑ 14 cm
 incl. SMD-LED, 20 W
 2.500 lm, 3.000 K



621210107
621210108



Deckenleuchte · Ceiling lamp
 Ø 62 cm, ↑ 18 cm
 incl. SMD-LED, 42 W
 5.600 lm, 3.000 K



621290107
621290108



CHARIVARI

Nickel matt oder Messing matt · nickel mat or brass mat ·
 nickel mat ou laiton mat · nikkell mat of messing mat ·
 níquel mate o bronce mate · nichel opaco o ottone satinato ·
 nichel mat sau bronz mat · harjattu teräs tai mattamessinki ·
 nikiel mat lub mosiądz mat

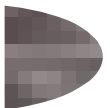

07 | Nickel matt · nickel mat



08 | Messing matt · brass mat



Tischleuchte · Table lamp
 ↓ 50 cm, Ø 41 cm
 incl. SMD-LED, 26 W
 2.500 lm, 3.000 K



521210107
 521210108



Stehleuchte · Floor lamp
 ↓ 175 cm, Ø 52 cm
 incl. SMD-LED, 31 W
 4.100 lm, 3.000 K



421210107
 421210108

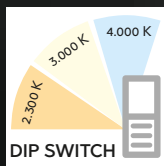

DIP SWITCH

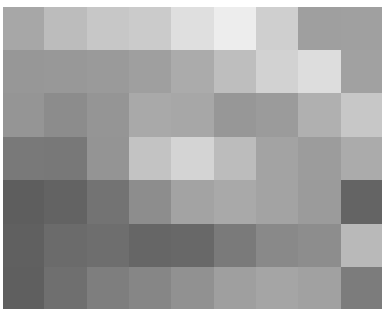

DIP SWITCH

Lichtfarben direkt an der Leuchte einstellbar · Colours directly adjustable at the lamp · Les couleurs de la lumière peuvent être réglées directement sur le luminaire · Lichtkleuren direct instelbaar op de lamp · Tonalidades de luz ajustables directamente en la lámpara · Colori della luce regolabili direttamente sulla lampada · Colori ale luminii reglabile direct de la bec · Valon väri asetettävissa suoraan valaisimesta · Barwy światła można ustawić bezpośrednio na oprawie



Deckenleuchte · Ceiling lamp
 Ø 59 cm, ↓ 14 cm
 incl. SMD-LED, 58 W
 7.000 lm, 2.300 + 3.000 + 4.000 K



626210107
626210131
626210132

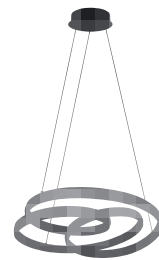

Pendelleuchte · Pendant
 Ø 60 cm, ↓ 150 cm
 incl. SMD-LED, 60 W
 7.200 lm, 2.300 + 3.000 + 4.000 K



326210107
326210131
326210132



NURIA

Metall, Acryl · metal, acryl ·
metale, acryl · metaal, acryl · metal, acrílico ·
metallo, acrilico · metal, acrylic · metalli, akryyli · metal, akryl

 Lichtfarbe einstellbar ·
Adjustable light color



07 | Nickel matt · nickel mat



31 | Weiß matt · white mat



32 | Schwarz matt · black mat



Stehleuchte · Floor lamp
↑ 150 cm, Ø 35 cm
incl. SMD-LED, 34 W
4.000 lm, 2.300 + 3.000 + 4.000 K



426219107
426219131
426219132

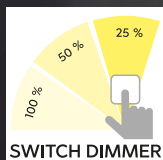

SWITCH DIMMER

FRANCIS

Metall, Aluminium gebürstet, Weiß matt oder Anthrazit · metal, brushed aluminium, white mat or anthracite ·
 metale, aluminium balayé, blanc mat ou antracite · metaal, geborsteld aluminium, wit mat of antraciet ·
 metal, aluminio pulido, estera blanca o antracita · metallo, alluminio spazzolato, bianco opaco o antracite ·
 metal, aluminiu lucios, alb mat sau antracit · metalli, harjattu alumiini, mattavalkoinen tai antrasiitti ·
 metal, aluminium szczotkowane, biały mat lub antracyt



05 | Aluminium gebürstet · brushed aluminium

31 | Weiß matt · white mat

42 | Anthrazit · anthracite



Deckenleuchte · Ceiling lamp

↔ 54 x 52 cm, ↑ 19,5 cm
 incl. SMD-LED, 40 W
 6.000 lm, 3.000 K



671310105
671310131
671310142



Pendelleuchte · Pendant

↔ 72 x 68 cm, ↑ 150 cm
 incl. SMD-LED, 52 W
 6.500 lm, 3.000 K



371310105
371310131
371310142



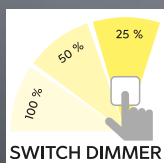

CARRERA

Metall, Acryl · metal, acryl ·
metale, acryl · metaal, acryl · metal, acrílico ·
metallo, acrilico · metal, acrylic · metalli, akryyli · metal, akryl



05 | Aluminium gebürstet · brushed aluminium



32 | Schwarz matt · black mat



Deckenleuchte · Ceiling lamp
Ø 45 cm, ↓ 22 cm
incl. SMD-LED, 38 W
4.400 lm, 3.000 K



625010105
625010132



Pendelleuchte · Pendant
↓ 150 cm, Ø 55 cm
incl. SMD-LED, 38 W
4.400 lm, 3.000 K



325010105
325010132

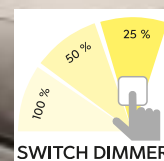

SWITCH DIMMER

OAKLAND

Metall, Nickel matt oder Anthrazit · metal, nickel mat or anthracite ·
 metale, nickel mat ou antracite · metaal, nikkell mat of antraciet ·
 metal, níquel mate o antracita · metallo, nichel opaco o antracite ·
 metal, nichel mat sau antracit · metalli, harjattu teräs tai antrasiitti ·
 metal, nikiel mat lub antracyt



07 | Nickel matt · nickel mat



42 | Anthrazit · anthracite



Deckenleuchte · Ceiling lamp
 Ø 53 cm, ↑ 23,5 cm
 incl. SMD-LED, 40 W
 5.200 lm, 3.000 K



621710107
 621710142



Pendelleuchte · Pendant
 Ø 71 cm, ↑ 150 cm
 incl. SMD-LED, 52 W
 6.200 lm, 3.000 K



321710107
 321710142



SYDNEY

Chrom, Acryl · chrome, acryl ·
 chrome, acryl · chroom, acryl ·
 cromo, acrílico · cromo, acrílico ·
 crom, acrylic · kromi, akryyli ·
 chrom, akryl



Deckenleuchte · Ceiling lamp
 ↔ 103 x 18 cm, ↑ 27 cm
 incl. SMD-LED, 18 W
 2.000 lm, 3.000 K



672910106



Tischleuchte · Table lamp
 ↓ 63 cm, Ø 20 cm
 incl. SMD-LED, 14,5 W
 1.300 lm, 3.000 K



572910106



Stehleuchte · Floor lamp
 ↓ 162 cm, Ø 25 cm
 incl. SMD-LED, 22 W
 2.500 lm, 3.000 K



472910106





SALERNO

Metall, weiß matt, schwarz matt oder goldfarbig/rost · metal, white mat, black mat or gold/rusty ·
 metale, blanc mat, noir mat ou or/rouill · metaal, wit mat, mat zwart of goud/roestkleur ·
 metal, estera blanca, estera negra o oro/óxido · metallo, bianco opaco, nero opaco o oro/ruggine ·
 metal, alb mat, negru mat sau aur/ruginiu · metalli, mattavalkoinen, mattamusta tai kultaa/rustiikki ·
 metal, biały mat, czarny mat lub złota/miedz

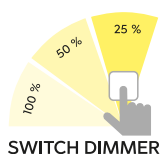

SWITCH DIMMER



31 | Weiß matt · white mat



4.000 Kelvin

32 | Schwarz matt · black mat

79 | goldfarbig/rost · gold/rusty



Pendelleuchte · Pendant

↔ 115 x 12 cm, ↑ 150 cm
 incl. SMD-LED, 35 W
 4.100 lm, 3.000 K
 (**31** = 4.100 lm, 4.000 K)



324610131
324610132
324610179



Stehleuchte · Floor lamp

↓ 140 cm, ↔ 22 x 22 cm
 incl. SMD-LED, 31 W
 2.900 lm, 3.000 K



424610132
424610179

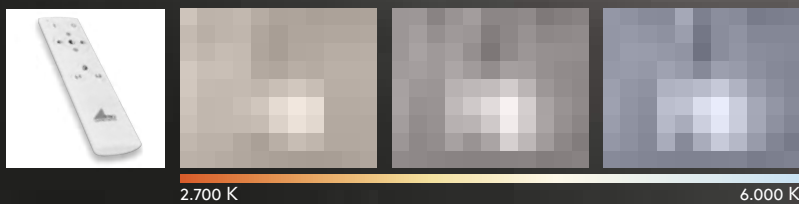

JIVE

Metall, Acryl · metal, acryl ·
metale, acryl · metaal, acryl · metal, acrílico ·
metallo, acrilico · metal, acrylic · metalli, akryyli ·
metal, akryl



07 | Nickel matt · nickel mat



31 | Weiß matt · white mat



32 | Schwarz matt · black mat



Deckenleuchte · Ceiling lamp
↔ 50 x 45,5 cm, ↓ 7,6 cm
incl. SMD-LED, 36 W
4.300 lm, 2.700 - 6.000 K



623410207
623410231
623410232



Deckenleuchte · Ceiling lamp
↔ 80 x 73 cm, ↓ 7,6 cm
incl. SMD-LED, 48 W
5.600 lm, 2.700 - 6.000 K



623419207
623419231
623419232



Stehleuchte · Floor lamp
↓ 118 cm, ↔ 32 x 24 cm
incl. SMD-LED, 23 W
2.700 lm, 2.700 + 4.000 + 6.000 K



423410107
423410131
423410132



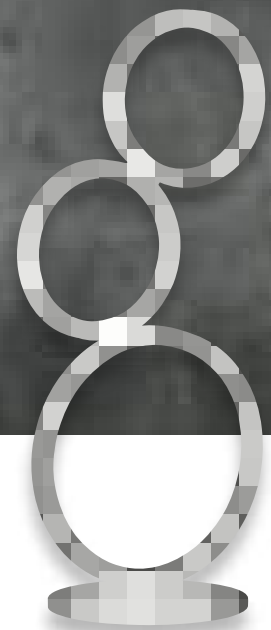
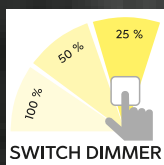
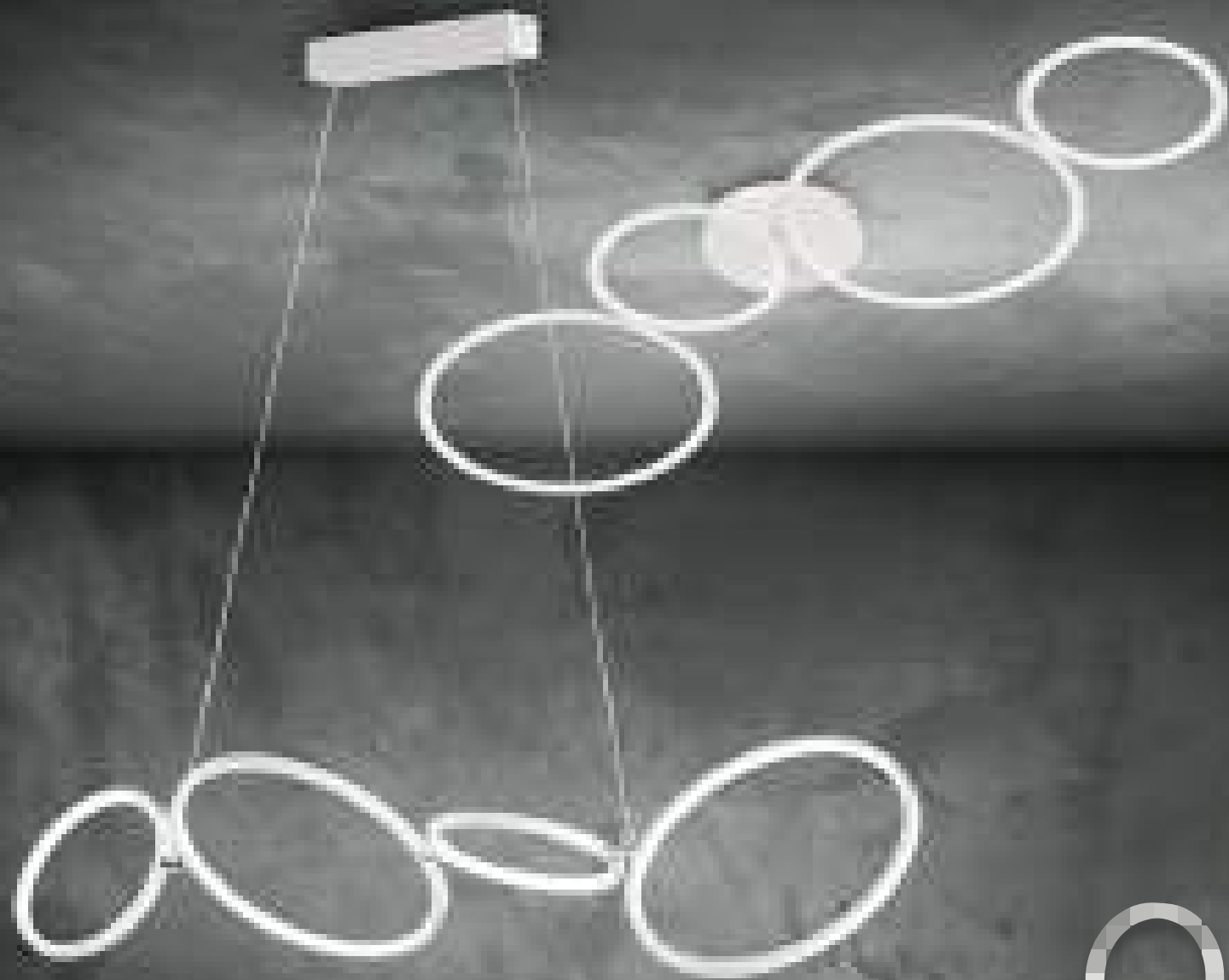

Deckenleuchte · Ceiling lamp
 ↔ 53 x 59 cm, ↑ 5,5 cm
 incl. SMD-LED, 49 W
 5.800 lm, 3.000 K



622610531
 622610532

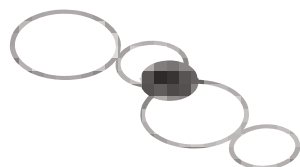

Deckenleuchte · Ceiling lamp
 ↔ 97 x 34,3 cm, ↑ 5,5 cm
 incl. SMD-LED, 37 W
 4.800 lm, 3.000 K



622610431
 622610432

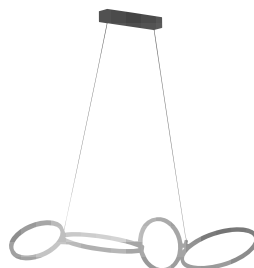

Pendelleuchte · Pendant
 ↔ 110 x 30 cm, ↑ 150 cm
 incl. SMD-LED, 37 W
 4.600 lm, 3.000 K



322610431
 322610432



Tischleuchte · Table lamp
 ↑ 45 cm, ↔ 20,7 cm
 incl. SMD-LED, 17 W
 1.900 lm, 3.000 K



522610331
 522610332



RONDO

Metall, Weiß matt oder Schwarz matt · metal, white mat or black mat ·
 metale, blanc mat ou noir mat · metaal, wit mat of mat zwart ·
 metal, estera blanca o estera negra · metallo, bianco opaco o nero opaco ·
 metal, alb mat sau negru mat · metalli, mattavalkoinen tai mattamusta ·
 metal, biały mat lub czarny mat



31 | Weiß matt · white mat



32 | Schwarz matt · black mat



Stehleuchte · Floor lamp
 ↓ 115 cm, ↔ 47 cm
 incl. SMD-LED, 36 W
 4.700 lm, 3.000 K



422610531
 422610532



Pendelleuchte · Pendant
 ↓ 150 cm, ↔ 30 cm
 incl. SMD-LED, 22 W
 1.950 lm, 3.000 K



322610232

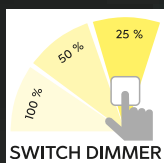

SWITCH DIMMER

RONDO

Metall, silberfarbig · metal, silver ·
metale, argent · metaal, zilver · metal, plata · metallo, argento ·
metal, argint · metalli, hopea · metal, srebrny



Deckenleuchte · Ceiling lamp
↔ 59 x 53 cm, ↓ 5,5 cm
incl. SMD-LED, 49 W
5.800 lm, 3.000 K



622610589



Deckenleuchte · Ceiling lamp
↔ 97 x 34,3 cm, ↓ 5,5 cm
incl. SMD-LED, 37 W
4.800 lm, 3.000 K



622610489

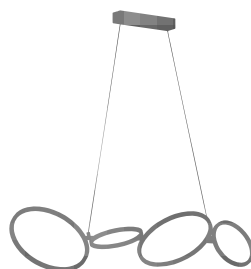

Pendelleuchte · Pendant
↔ 110 x 30 cm, ↓ 150 cm
incl. SMD-LED, 37 W
4.600 lm, 3.000 K



322610489



Tischleuchte · Table lamp
↓ 45 cm, ↔ 20,7 cm
incl. SMD-LED, 17 W
1.900 lm, 3.000 K



522610389



Stehleuchte · Floor lamp
↓ 115 cm, ↔ 47 cm
incl. SMD-LED, 36 W
4.700 lm, 3.000 K



422610589



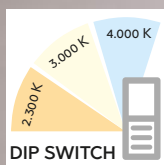

Deckenleuchte · Ceiling lamp

↔ 107,5 x 18 cm, ↑ 7 cm
incl. SMD-LED, 35 W
4.300 lm, 2.300 + 3.000 + 4.000 K



641210305
641210308



Pendelleuchte · Pendant

↑ 150 cm, ↔ 107,5 x 15,5 cm
incl. SMD-LED, 35 W
4.300 lm, 2.300 + 3.000 + 4.000 K



341210305
341210308



Tischleuchte · Table lamp

↑ 48 cm, ↔ 13,5 cm
incl. SMD-LED, 8 W
750 lm, 2.300 + 3.000 + 4.000 K



541210205
541210208



Stehleuchte · Floor lamp

↑ 138 cm, ↔ 20,5 cm
incl. SMD-LED, 28 W
3.250 lm, 2.300 + 3.000 + 4.000 K





441210305
441210308



BLAZE

Metall, Aluminium gebürstet oder Messing matt, Schwarz matt · metal, brushed aluminium or brass mat, black mat ·
 métal, aluminium balayé ou laiton mat, noir mat · metaal, geborsteld aluminium of messing mat, mat zwart ·
 metal, aluminio pulido o bronce mate, estera negra · metallo, alluminio spazzolato o ottone satinato, nero opaco ·
 metal, aluminiumu liciosau bronz mat, negru mat · metalli, harjattu alumiini tai mattamessinki, mattamusta ·
 metal, aluminiumu szczotkowane lub mosiądz mat, czarny mat

 Lichtfarbe einstellbar ·
 Adjustable light color

 **05** | Aluminium gebürstet ·
 brushed aluminium

 **08** | Messing matt · brass mat



2.300 K



3.000 K



4.000 K



Pendelleuchte · Pendant
 ↔ 118,5 x 19,3 cm, ↓ 150 cm
 incl. SMD-LED, 35 W
 4.100 lm, 2.300 + 3.000 + 4.000 K



326810131
326810132



Tischleuchte · Table lamp
 ↓ 44 cm, ↔ 21 x 17,5 cm
 incl. SMD-LED, 9 W
 950 lm, 2.300 + 3.000 + 4.000 K



526810131
526810132



Stehleuchte · Floor lamp
 ↓ 124 cm, ↔ 21 x 17,5 cm
 incl. SMD-LED, 26 W
 2.950 lm, 2.300 + 3.000 + 4.000 K



426810131
426810132

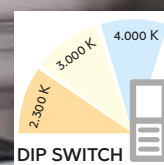

EDGE

Metall, Weiß matt oder Schwarz matt / Messing matt · metal, white mat or black mat / brass mat ·
 metale, blanc mat ou noir mat / laiton mat · metaal, wit mat of mat zwart / messing mat ·
 metal, estera blanca o estera negra / bronce mate · metallo, bianco opaco o nero opaco / ottone satinato ·
 metal, alb mat sau negru mat / bronz mat · metalli, mattavalkoinen tai mattamusta / mattamessinki ·
 metal, biały mat lub czarny mat / mosiądz mat

 Lichtfarbe einstellbar ·
 Adjustable light color

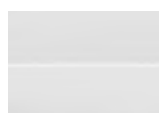

31 | Weiß matt · white mat



32 | Schwarz matt · black mat



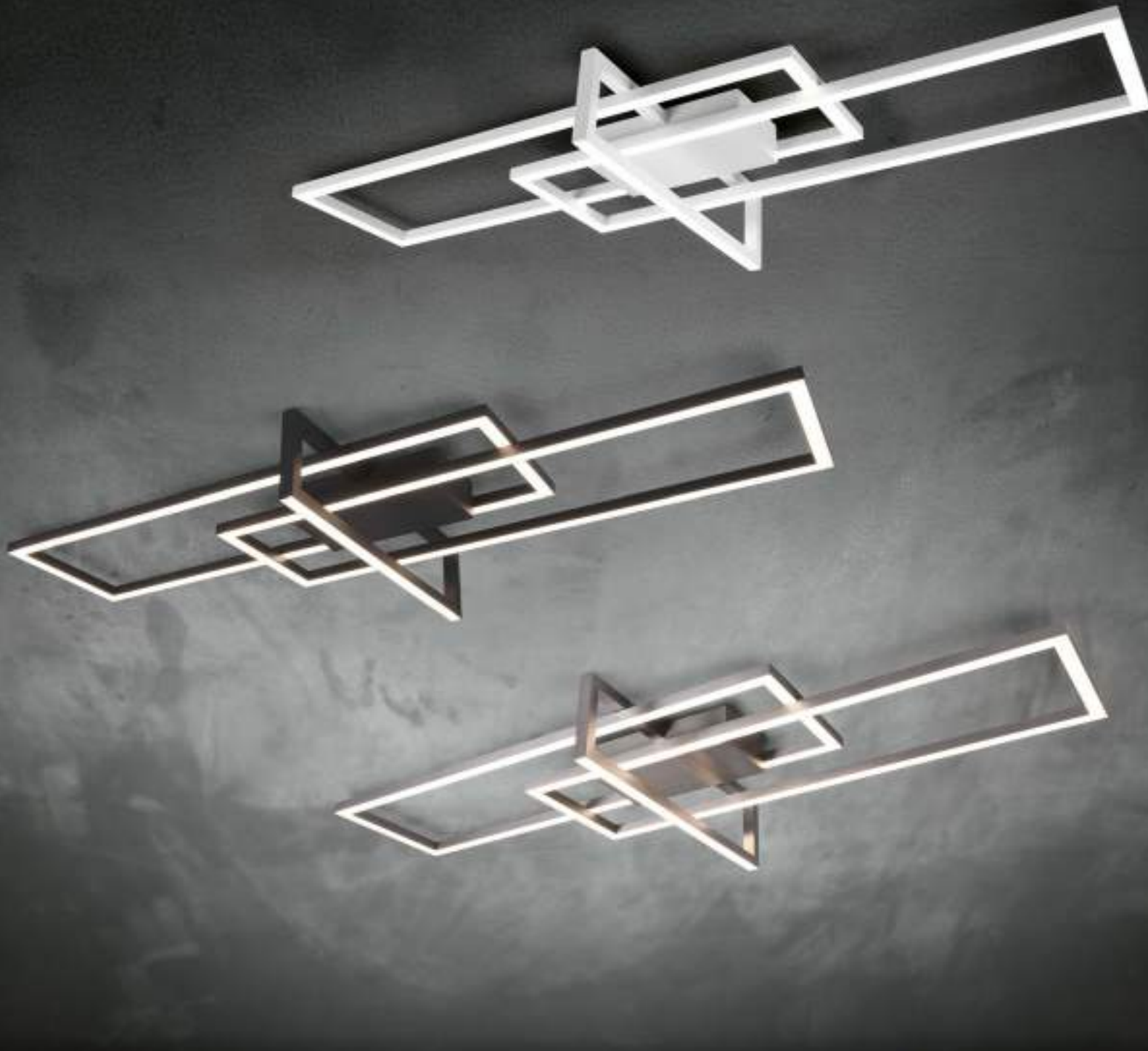

Deckenleuchte · Ceiling lamp
 ↔ 100 x 40 cm, ↑ 11,5 cm
 incl. SMD-LED, 34 W
 3.900 lm, 3.000 K
 (31 = 4.100 lm, 4.000 K)



- 620310307
- 620310308
- 620310331
- 620310332



Pendelleuchte · Pendant
 ↓ max. 150 cm, ↔ 110 x 40 cm
 incl. SMD-LED, 34 W
 4.200 lm, 3.000 K
 (31 = 4.400 lm, 4.000 K)



- 320310307
- 320310308
- 320310331
- 320310332



- 07** | Nickel matt · nickel mat
- 08** | Messing matt / Schwarz matt
brass matt / black mat
- 31** | Weiß matt · white mat
- 32** | Schwarz matt · black mat

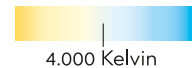



SALINAS

Metall · metal ·
 metale · metaal · metal ·
 metallo · metal · metalli · metal

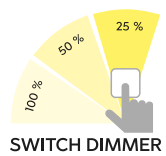

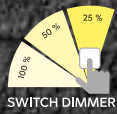

SWITCH DIMMER

BELFAST

Metall, Nickel matt oder Schwarz matt · metal, nickel mat or black mat ·
 metale, nickel mat ou noir mat · metaal, nikkel mat of mat zwart ·
 metal, níquel mate o estera negra · metallo, nichel opaco o nero opaco ·
 metal, nichel mat sau negru mat · metalli, harjattu teräs tai mattamusta ·
 metal, nikiel mat lub czarny mat

 indirekte Beleuchtung ·
 indirect lighting

 **07** | Nickel matt · nickel mat

 **32** | Schwarz matt · black mat



Wandleuchte · Wall lamp
 ↔ 60 x 30 cm, ∇ 7
 incl. 2 x SMD-LED, 10,5 W
 2 x 1.050 lm, 3.000 K



275510207
275510232

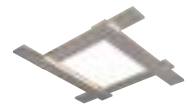

Deckenleuchte · Ceiling lamp
 ↔ 59 x 59 cm, ↓ 6,5 cm
 incl. SMD-LED, 18 W
 1.700 lm, 3.000 K
 incl. 4 x SMD-LED, 3,5 W
 4 x 350 lm, 3.000 K



675510507
675510532

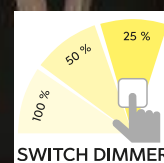

SWITCH DIMMER



Pendelleuchte · Pendant
 ↔ 115,5 x 14,2 cm, ↓ 150 cm
 incl. SMD-LED, 44 W
 4.400 lm, 3.000 K



375510407
375510432

Gibt Licht nach oben und unten · up and down lighting ·
 point lumineux en haut et en bas · lichtpunt boven en onder · luz de arriba y abajo ·
 luce su e giù · sus și în jos lumina · ylös ja alas valoa · w górę iw dół światło



Deckenleuchte · Ceiling lamp

↔ 52,5 x 52,5 cm, ↑ 16 cm

incl. SMD-LED, 24 W

2.800 lm, 3.000 K



627710405

627710432

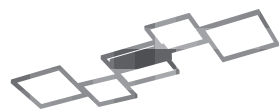

Deckenleuchte · Ceiling lamp

↔ 120,5 x 48,5 cm, ↑ 6 cm

incl. SMD-LED, 34 W

4.500 lm, 3.000 K



627710505

627710532

SORRENTO

Metall · metal ·

metale · metaal · metal · metallo · metal · metalli · metal

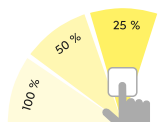

SWITCH DIMMER



05 | Aluminium gebürstet ·
brushed aluminium



32 | Schwarz matt ·
black mat

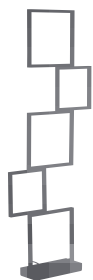

Stehleuchte · Floor lamp

↑ 125 x 12,5 cm, ↔ 48 cm

incl. SMD-LED, 34 W

4.500 lm, 3.000 K



427710505

427710532



Tischleuchte · Table lamp

↑ 50 x 13 cm, ↔ 24 cm

incl. SMD-LED, 15 W

1.500 lm, 3.000 K



527710305

527710332

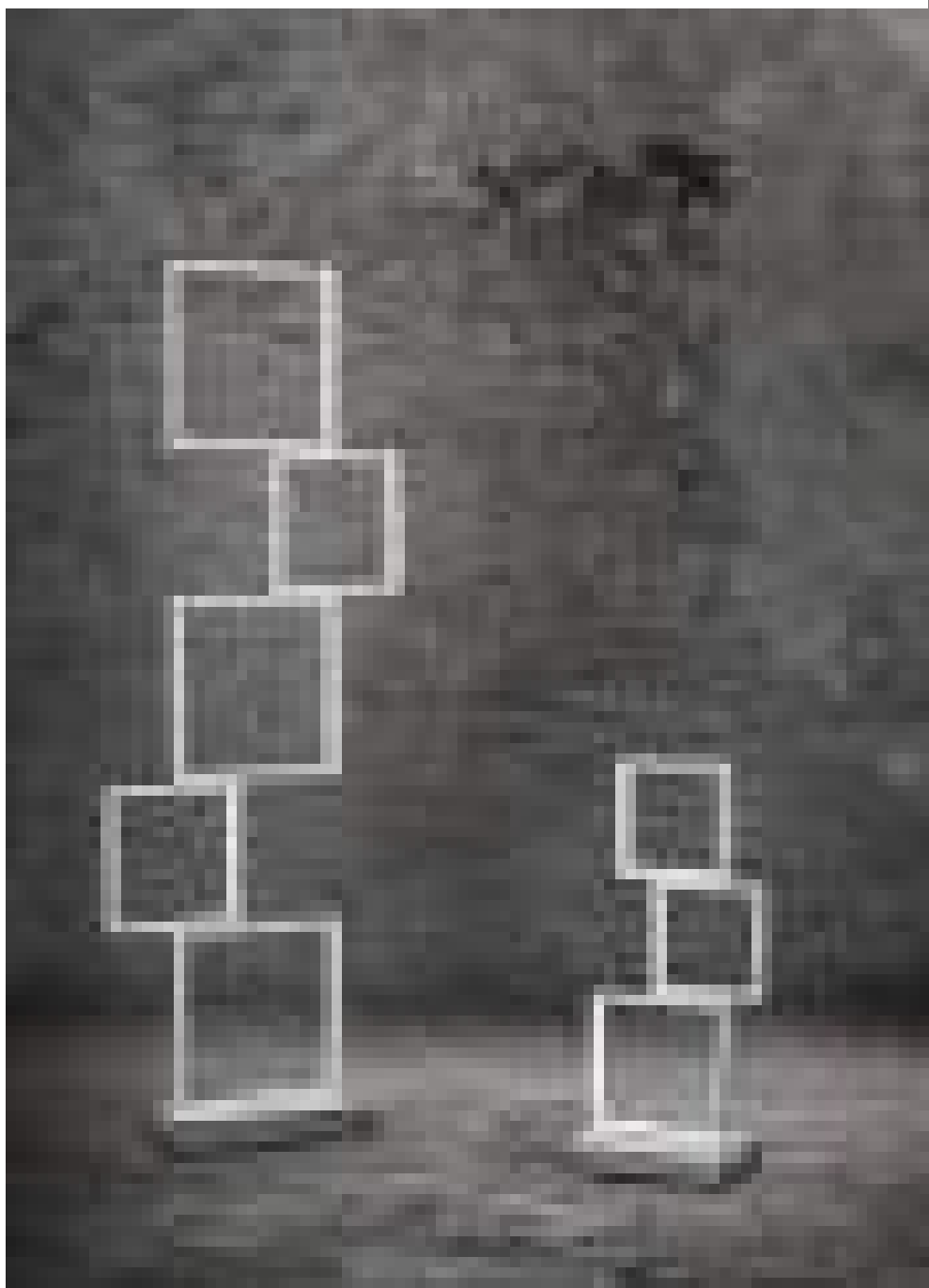





HARPER

Metall, Schwarz matt, Holz naturbelassen · metal, black mat, wood natural finish ·
 métal, noir mat, bois finition naturelle · metaal, mat zwart, hout natuurlijke afwerking ·
 metal, estera negra, madera acabado natural · metallo, nero opaco, di legno finitura naturale ·
 metal, negru mat, lemn finisaj natural · metalli, mattamusta, puu luonnollinen viimeistely ·
 metal, czarny mat, drewno naturalne wykończenie

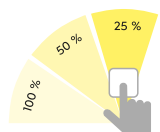

SWITCH DIMMER



Deckenleuchte · Ceiling lamp
 ↔ 65 x 34,5 cm, ↑ 7,5 cm
 incl. SMD-LED, 30 W
 4.000 lm, 3.000 K



622910332



Deckenleuchte · Ceiling lamp
 ↔ 115 x 44,5 cm, ↑ 7,5 cm
 incl. SMD-LED, 42 W
 5.700 lm, 3.000 K



622910532



Pendelleuchte · Pendant
 ↑ 150 cm, ↔ 115 x 44,5 cm
 incl. SMD-LED, 42 W
 5.700 lm, 3.000 K



322910532



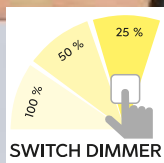

Pendelleuchte · Pendant
 ↔ 115 x 6,5 cm, ↓ 150 cm
 incl. SMD-LED, 27,5 W
 3.150 lm, 3.000 K



326410130



Stehleuchte · Floor lamp
 ↓ 115 cm, ↔ 22 x 22 cm
 incl. SMD-LED, 20 W
 2.300 lm, 3.000 K



426410130



4 fach TOUCH ·
 4 level Touch function





BELLARI

Holz, Metall Schwarz matt · wood, metal black mat ·
 bois, metale noir mat · hout, metaal mat zwart · madera, metal estera negra ·
 di legno, metallo nero opaco · lemn, metal negru mat · puu, metalli mattamusta ·
 drewno, metal czarny mat



Lichtfarbe stufenlos einstellbar ·
 Light color infinitely variable



Integrierter Dimmer ·
 Integrated dimmer



2.700 K

6.000 K



Deckenleuchte · Ceiling lamp

↔ 180 x 10 cm, ↑ 13,5 cm
 incl. SMD-LED, 36 W
 4.200 lm, 2.700 - 6.000 K



626410530



KERALA

Metall, Schwarz matt, Holz naturbelassen · metal, black mat, wood natural finish ·
 métal, noir mat, bois finition naturelle · metaal, mat zwart, hout natuurlijke afwerking ·
 metal, estera negra, madera acabado natural · metallo, nero opaco, di legno finitura naturale ·
 metal, negru mat, lemn finisaj natural · metalli, mattamusta, puu luonnollinen viimeistely ·
 metal, czarny mat, drewno naturalne wykończenie

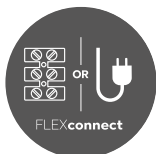

Seite/page 632



Wandleuchte · Wall lamp
 ↑ 7 cm, ↔ 30 cm, ↗ 13 cm
 incl. SMD-LED, 9 W
 1.100 lm, 3.000 K



241670132

Deckenleuchte · Ceiling lamp
 ↔ 83 x 14,5 cm, ↓ 11,5 cm
 incl. 2 x SMD-LED, 12,5 W
 2 x 1.500 lm, 3.000 K



641610232



Pendelleuchte · Pendant
 ↓ 150 cm, ↔ 90 x 8,5 cm
 incl. SMD-LED, 25 W
 3.000 lm, 3.000 K



341610132



Tischleuchte · Table lamp
 ↓ 50 cm, ↔ 11 x 14 cm
 incl. SMD-LED, 8 W
 950 lm, 3.000 K



541610132



Stehleuchte · Floor lamp
 ↓ 120 cm, ↔ 19 x 13 cm
 incl. SMD-LED, 16 W
 1.950 lm, 3.000 K



441610132



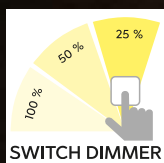

DEACON

Metall, Nickel matt oder Schwarz matt, Holz · metal, nickel mat or black mat, wood ·
 metale, nickel mat ou noir mat, bois · metaal, nikkell mat of mat zwart, hout · metal, níquel mate o estera negra, madera ·
 metallo, nichel opaco o nero opaco, di legno · metal, nichel mat sau negru mat, lemn · metalli, harjattu teräs tai mattamusta, puu ·
 metal, nikiel mat lub czarny mat, drewno



07 | Nickel matt, Holz ·
 nickel mat, wood



32 | Schwarz matt, Holz ·
 black mat, wood



Deckenleuchte · Ceiling lamp
 Ø 50 cm, ↓ 7 cm
 incl. SMD-LED, 37 W
 4.400 lm, 3.000 K



626610207
 626610232



Lichtfarbe stufenlos einstellbar ·
Light color infinitely variable



Sensordimmer ·
Sensor dimmer



Pendelleuchte · Pendant
↔ 110 x 6,5 cm, ↑ 150 cm
incl. SMD-LED, 42 W
3.200 lm, 2.700 - 6.000 K



326610207
326610232



CAMDEN

Nickel matt, Stoffschirm · nickel mat, fabric shade ·
 nickel mat, abat-jour tissu · nikkel mat, Stoffen kap · níquel mate, Pantalla de tela ·
 nichel opaco, paralume in tessuto · nichel mat, abajur textil · harjattu teräs, kangas varjostin ·
 nikiel mat, Klosz z materiału



Deckenleuchte · Ceiling lamp
 Ø 50 cm, ↑ 35 cm
 excl. 3 x E27, max. 40 W



608300307

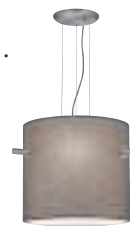

Pendelleuchte · Pendant
 Ø 50 cm, ↑ 150 cm
 excl. 3 x E27, max. 40 W



308300307





Stehleuchte · Floor lamp
 ↑ 145 - 180 cm, Ø 50 cm
 excl. 3 x E27, max. 40 W



408300307



 Höhenverstellbar ·
Adjustable height

 Getrennt schaltbar ·
Separately switchable





CAMDEN

Messing matt, Stoffschirm · brass mat, fabric shade ·
 laiton mat, abat-jour tissu · messing mat, Stoffen kap ·
 bronze mate, Pantalla de tela · ottone satinato, paralume
 in tessuto · bronz mat, abajur textil · mattamessinki,
 kangas varjostin · mosiądz mat, Klosz z materiału



Pendelleuchte · Pendant
 Ø 50 cm, ↓ 150 cm
 excl. 3 x E27, max. 40 W



308300308



Deckenleuchte · Ceiling lamp
 Ø 50 cm, ↓ 35 cm
 excl. 3 x E27, max. 40 W



608300308



Stehleuchte · Floor lamp
 ↓ 145 - 180 cm, Ø 50 cm
 excl. 3 x E27, max. 40 W



408300308



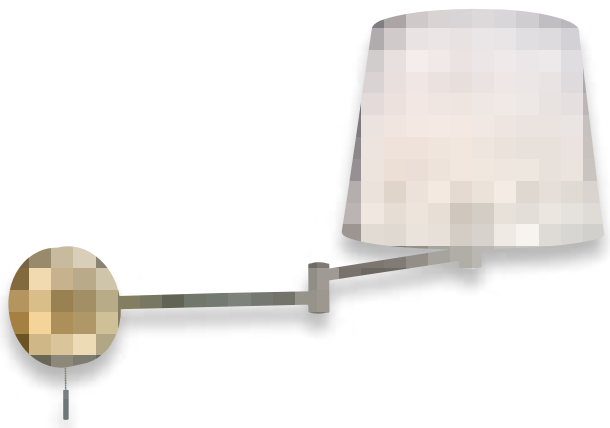

Wandleuchte · Wall lamp

↑ 32,5 x 25,5 cm, ↗ 69 cm
excl. 1 x E27, max. 60 W



209100107
209100108

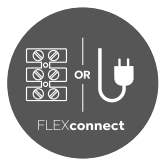

Seite/page 632

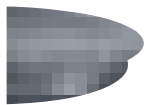

07 | Nickel matt · nickel mat

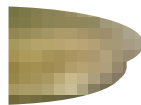

08 | Messing matt · brass mat



Tischleuchte · Table lamp

↑ 45 - 56 cm, Ø 25,5 cm
excl. 1 x E27, max. 60 W



509100107
509100108





LYON

Nickel matt oder Messing matt, Stoffschirm · nickel mat or brass mat, fabric shade ·
 nickel mat ou laiton mat, abat-jour tissu · nikkel mat of messing mat, Stoffen kap ·
 níquel mate o bronce mate, Pantalla de tela · nichel opaco o ottone satinato, paralume in tessuto ·
 nichel mat sau bronz mat, abajur textil · harjattu teräs tai mattamessinki, kangas varjostin ·
 nikiel mat lub mosiądz mat, Klosz z materiału



Getrennt schaltbar · Separately switchable ·
 Interrupteurs séparés · Gescheiden schakelbaar ·
 Interruptores separados · Interruttori separati ·
 Intrerupatoare separate · Erikseen kytkettävissä ·
 Oddzielny przełącznik



Stehleuchte · Floor lamp
 ↑ 138 - 180 cm, Ø 46,3 cm
 excl. 3 x E27, max. 60 W



409100307
 409100308



BURTON

Metall, Schwarz matt, Stoffschirm · metal, black mat, fabric shade ·
 métal, noir mat, abat-jour tissu · metaal, mat zwart, stoffen kap · metal, estera negra, pantalla de tela ·
 metallo, nero opaco, paralume in tessuto · metal, negro mat, abajur textil · metalli, mattamusta, kangas varjostin ·
 metal, czarny mat, klosz z materiału



Pendelleuchte · Pendant
 ↓ 150 cm, Ø 45 cm
 excl. 1 x E27, max. 40 W



311400132



Pendelleuchte · Pendant
 ↓ 95 - 150 cm, ↔ 82,5 x 12,5 cm
 excl. 4 x E14, max. 40 W



311400432



Tischleuchte · Table lamp
 ↓ 28,5 cm, Ø 12,5 cm
 excl. 1 x E14, max. 40 W



511400132

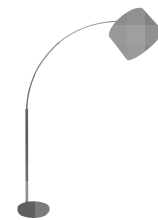

Stehleuchte · Floor lamp
 ↓ 171 cm, √ 114 cm
 excl. 1 x E27, max. 40 W



411490132







BURTON

Metall, Schwarz matt, Stoffschirm · metal, black mat, fabric shade ·
 métal, noir mat, abat-jour tissu · metaal, mat zwart, stoffen kap · metal, estera negra, pantalla de tela ·
 metallo, nero opaco, paralume in tessuto · metal, negru mat, abajur textil · metalli, mattamusta, kangas varjostin ·
 metal, czarny mat, klosz z materiału



Deckenleuchte · Ceiling lamp
 ↔ 65 x 55 cm, ↑ 21,5 cm
 excl. 3 x E27, max. 40 W



611490332

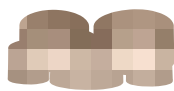

Deckenleuchte · Ceiling lamp
 ↔ 90 x 70 cm, ↑ 21,5 cm
 excl. 5 x E27, max. 40 W



611400532



Stehleuchte · Floor lamp
 ↑ 150 cm, Ø 35 cm
 excl. 1 x E27, max. 40 W



411400132



Stehleuchte · Floor lamp
 ↑ 174 cm, Ø 45 cm
 excl. 1 x E27, max. 60 W
 excl. 1 x E14, max. 40 W



411400232



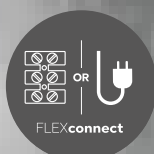

Seite/page 632

BURTON

Metall, Schwarz matt, Stoffschirm · metal, black mat, fabric shade ·
 métal, noir mat, abat-jour tissu · metaal, mat zwart, stoffen kap · metal, estera negra, pantalla de tela ·
 metallo, nero opaco, paralume in tessuto · metal, negru mat, abajur textil · metalli, mattamusta, kangas varjostin ·
 metal, czarny mat, klosz z materiału



Strahler · Spot
 ↓ 19,5 cm, ↔ 10 cm, ↗ 18,5 cm
 excl. 1 x E14, max. 28 W



811400132



Strahler · Spot
 ↔ 32,5 x 18 cm, ↓ 19,5 cm
 excl. 2 x E14, max. 28 W



811400232



Strahler · Spot
 ↔ 71,5 x 18 cm, ↓ 19,5 cm
 excl. 4 x E14, max. 28 W



811400432



Strahler · Spot
 Ø 49 cm, ↓ 22 cm
 excl. 3 x E14, max. 28 W



811430332

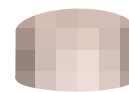

Deckenleuchte · Ceiling lamp
 Ø 50 cm, ↓ 25 cm
 excl. 3 x E27, max. 40 W



611400332





Deckenleuchte · Ceiling lamp

↔ 75 x 44,2 cm, ↓ 22 cm
excl. 5 x E14, max. 25 W



605400501
605400511
605400541
605400579
605400589



Tischleuchte · Table lamp

↑ 18 cm, Ø 9,5 cm
excl. 1 x E14, max. 25 W



595400101
595400111
595400141
595400179
595400189





GARDA

Nickel matt, Stoffschirm · nickel mat, fabric shade ·
 nickel mat, abat-jour tissu · nikkel mat, Stoffen kap · níquel mate, Pantalla de tela ·
 nichel opaco, paralume in tessuto · nichel mat, abajur textil · harjattu teräs, kangas varjostin ·
 nikiel mat, Klosz z materiału



01 | Weiß · white



79 | goldfarbig · gold

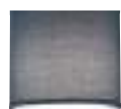

11 | Grau · grey



89 | silberfarbig · silver



41 | Taupe · taupe



Pendelleuchte · Pendant
 ↔ 77 x 13,5 cm, ↓ 95 - 150 cm
 excl. 4 x E14, max. 28 W



305400401
 305400411
 305400441
 305400479
 305400489



Deckenleuchte · Ceiling lamp
 Ø 30 cm, ↓ 22 cm
 excl. 2 x E14, max. 40 W



608200279



Tischleuchte · Table lamp
 ↓ 33 cm, Ø 20 cm
 excl. 1 x E27, max. 40 W



508200179



Stehleuchte · Floor lamp
 ↓ 160,5 cm, Ø 35 cm
 excl. 1 x E27, max. 60 W



408200179



HOSTEL

Metall, Stoffschirm innen goldfarbig · metal, fabric shade gold colored inside ·
 metale, abat-jour tissu Or · metaal, Stoffen kap Binnenkant goudkleur ·
 metal, Pantalla de tela Interior en color dorado · metallo, paralume in tessuto
 interno colore oro · metal, abajur textil interior culoare aurie · metalli, kangas
 varjostin sisäosa kullanvärinen · metal, Klosz z materiału wewnątrz złoty



Pendelleuchte · Pendant
 Ø 40 cm, ↓ 150 cm
 excl. 1 x E27, max. 60 W



308200179



Stehleuchte · Floor lamp
 ↓ max. 156 cm, Ø 35 cm, ↗ max. 63 cm
 excl. 1 x E27, max. 60 W



408290179



IBIS

Stoffschirm, Nickel matt · fabric shade, nickel mat ·
 abat-jour tissu, nickel mat · Stoffen kap, nikkell mat ·
 Pantalla de tela, níquel mate · paralume in tessuto, nichel opaco ·
 abajur textil, nichel mat · kangas varjostin, harjattu teräs ·
 Klosz z materiału, nikiel mat



Deckenleuchte · Ceiling lamp
 Ø 45 cm, ↓ 39,6 cm
 excl. 3 x E27, max. 40 W



609400317



Pendelleuchte · Pendant
 ↓ 150 cm, Ø 45 cm
 excl. 3 x E27, max. 40 W



309400317





HOTEL

Stoffschirm, mehrfarbig · fabric shade, multicolor ·
abat-jour tissu, multicolore · Stoffen kap, multicolor · Pantalla de tela, multicolor ·
paralume in tessuto, multicolore · abajur textil, multicolor · kangas varjostin, monivärinen · Klosz z materiału, multi-kolor

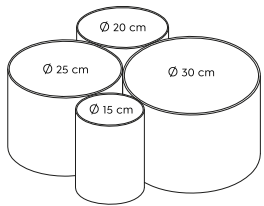

Deckenleuchte · Ceiling lamp
↔ 50,5 x 47 cm, ↑ 21,5 cm
excl. 4 x E27, max. 42 W



693900417

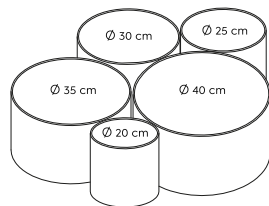

Deckenleuchte · Ceiling lamp
↔ 90 x 70 cm, ↑ 21,5 cm
excl. 5 x E27, max. 42 W



693900517

Empfohlen:
recommended: LED E27, 5 W
400 lm, 3.000 K



986-60

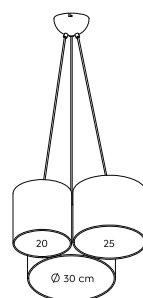

Pendelleuchte · Pendant
 ↔ 45,4 x 52,5 cm, ↓ 150 cm
 excl. 3 x E27, max. 42 W



393900317

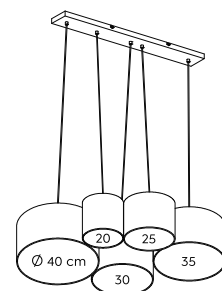

Pendelleuchte · Pendant
 ↔ 96,5 x 68,5 cm, ↓ 150 cm
 excl. 5 x E27, max. 42 W



393900517



01 | Weiß · white



02 | Schwarz · black



11 | Grau · grey



Deckenleuchte · Ceiling lamp
 Ø 30 cm, ↓ 16 cm
 excl. 2 x E14, max. 40 W



603900201
 603900202
 603900211



Deckenleuchte · Ceiling lamp
 Ø 50 cm, ↓ 17 cm
 excl. 3 x E27, max. 60 W



603900301
 603900302
 603900311



Deckenleuchte · Ceiling lamp
 Ø 65 cm, ↓ 17 cm
 excl. 5 x E27, max. 60 W



603900501
 603900502
 603900511

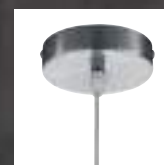

HOTEL

Nickel matt, Stoff · nickel mat, fabric ·
 nickel mat, tissu · nikkel mat, textiel · níquel mate, tela ·
 nichel opaco, tessuto · nichel mat, textil · harjattu teräs, tekstiili · nikiel mat, tkanina



01 | Weiß · white

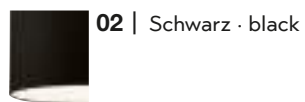

02 | Schwarz · black



11 | Grau · grey

Empfohlen:
 recommended: LED E27, 10 W
 806 lm, 3.000 K



988-10



Pendelleuchte · Pendant
 Ø 40 cm, ↓ 150 cm
 excl. 1 x E27, max. 60 W



303300101
 303300102
 303300111



Stehleuchte · Floor lamp

↑ 160 cm, Ø 35 cm
excl. 1 x E27, max. 60 W



401100101
401100102
401100111

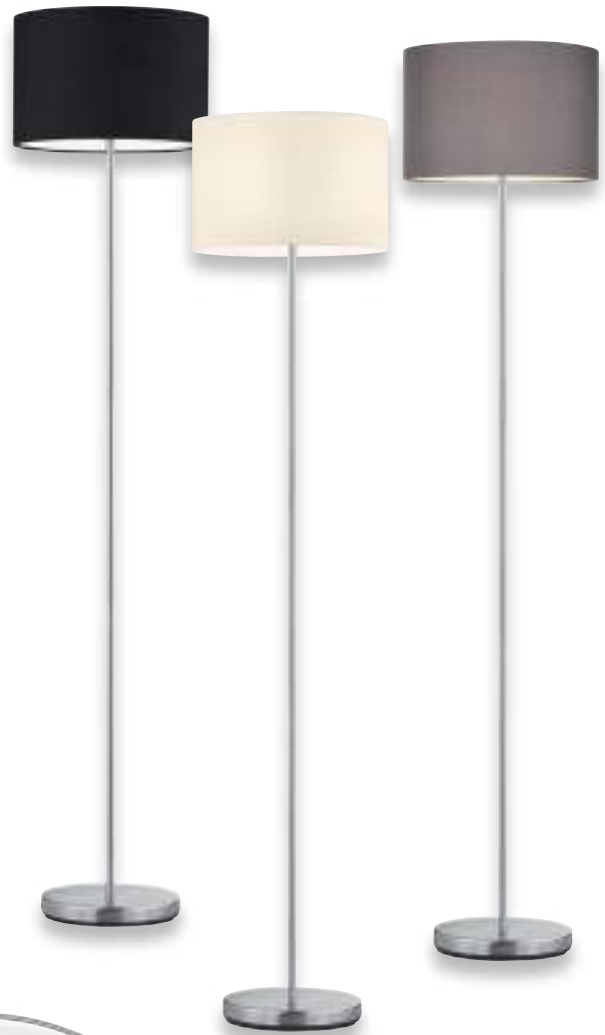

HOTEL

Metall, Stoffschirm · metal, fabric shade ·
metale, abat-jour tissu · metaal, Stoffen kap ·
metal, Pantalla de tela · metallo, paralume in tessuto ·
metal, abajur textil · metalli, kangas varjostin ·
metal, Klosz z materiału



01 | Weiß · white



02 | Schwarz · black



11 | Grau · grey



Stehleuchte · Floor lamp

↑ 150 - 215 cm, Ø 30 cm, √ 107 cm
excl. 1 x E27, max. 60 W



461100101
461100102
461100111



01 | Nickel matt, Schirm Weiß · nickel mat, shade white



08 | Messing matt, Schirm Creme-Weiß · brass mat, shade cream white



11 | Nickel matt, Schirm Grau · nickel mat, shade grey



Stehleuchte · Floor lamp
 ↑ 170 cm, Ø 40 cm, ↗ 35 cm
 excl. 1 x E27, max. 60 W
 excl. 1 x E14, max. 18 W



403900201
 403900208
 403900211

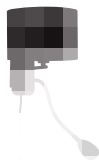

Wandleuchte · Wall lamp
 † 23,5 x 20 cm, ∅ max. 34,5 cm
 incl. 1 x COB-LED, 3,1 W
 310 lm, 3.000 K
 excl. 1 x E14, max. 40 W



271170201
 271170202
 271170211

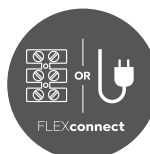
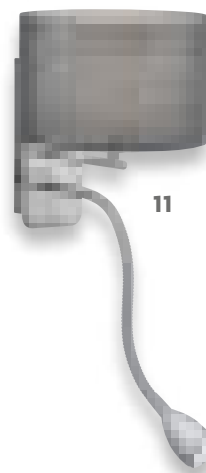
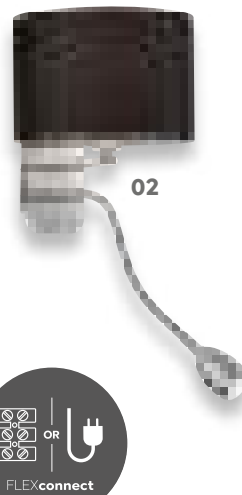
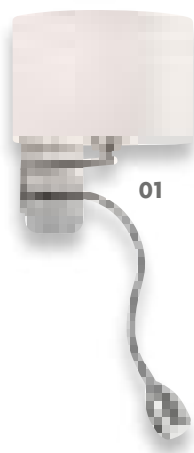

Seite/page 632



HOTEL

Nickel matt, Stoff · nickel mat, fabric ·
 nickel mat, tissu · nikkel mat, textiel · níquel mate, tela ·
 nichel opaco, tessuto · nichel mat, textil · harjattu teräs, tekstiili ·
 nikiel mat, tkanina

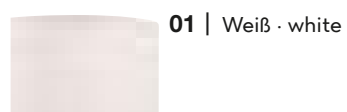

01 | Weiß · white

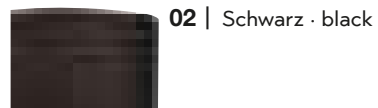

02 | Schwarz · black



11 | Grau · grey



Tischleuchte · Table lamp
 ↓ 32 cm, Ø 20 cm
 excl. 1 x E14, max. 40 W



501100101
 501100102
 501100111



Tischleuchte · Table lamp
 ↓ 55 cm, Ø 30 cm
 excl. 1 x E27, max. 60 W



511100101
 511100102
 511100111



BARONESS

Metall, Weiß matt oder Anthrazit, Acryl weiß · metal, white mat or anthracite, acryl white ·
 metale, blanc mat ou antracite, acryl blanc · metaal, wit mat of antraciet, acryl wit ·
 metal, estera blanca o antracita, acrílico blanco · metallo,
 bianco opaco o antracite, acrilico bianco · metal, alb mat
 sau antracit, acrilic alb · metalli, mattavalkoinen tai
 antrasiitti, akryyli valkoinen · metal, biały mat lub antracyt,
 akryl biały



31 | Weiß matt · white mat



42 | Anthrazit · anthracite



Pendelleuchte · Pendant
 ↓ 150 cm, Ø 45 cm
 excl. 3 x E27, max. 15 W



308900331
 308900342



Pendelleuchte · Pendant
 ↔ 105 cm, ↓ 150 cm, Ø 25 cm
 excl. 6 x E14, max. 15 W



308900631
 308900642



Deckenleuchte · Ceiling lamp
 Ø 45 cm, ↓ 23 cm
 excl. 3 x E27, max. 15 W



608900331
 608900342





BARON

Metall, Weiß matt oder Schwarz matt, Acryl · metal, white mat or black mat, acryl ·
 metale, blanc mat ou noir mat, acryl · metaal, wit mat of mat zwart, acryl ·
 metal, estera blanca o estera negra, acrílico · metallo, bianco opaco o nero opaco, acrilico ·
 metal, alb mat sau negru mat, acrilic · metalli, mattavalkoinen tai mattamusta, akryyli ·
 metal, biały mat lub czarny mat, akryl



Deckenleuchte · Ceiling lamp
 Ø 52 cm, ↑ 24 cm
 excl. 4 x E27, max. 40 W



609800431
 609800432



Pendelleuchte · Pendant
 Ø 52 cm, ↑ 150 cm
 excl. 4 x E27, max. 40 W



309800431
 309800432



31 | Weiß matt · white mat



32 | Schwarz matt · black mat





Deckenleuchte · Ceiling lamp
 Ø 40 cm, ↑ 15 cm
 excl. 3 x E27, max. 25 W



603500331
 603500332

Empfohlen:
 recommended: LED E27, 7 W
 560 lm, 3.000 K



988-700



31 | Weiß matt · white mat



32 | Schwarz matt · black mat



Wandleuchte · Wall lamp
 ↔ 40 x 13 cm, ↗ 6,5
 incl. 2 x SMD-LED, 6,5 W
 2 x 700 lm, 3.000 K

223510231
 223510232



Wandleuchte · Wall lamp
 ↔ 18 x 13 cm, ↗ 6 cm
 incl. 1 x SMD-LED, 6,5 W
 700 lm, 3.000 K

223510131
 223510132



ZANDOR

Metall, Weiß matt oder Schwarz matt, Acryl · metal, white mat or black mat, acryl ·
 metale, blanc mat ou noir mat, acryl · metaal, wit mat of mat zwart, acryl ·
 metal, estera blanca o estera negra, acrílico · metallo, bianco opaco o nero opaco, acrilico ·
 metal, alb mat sau negru mat, acrilic · metalli, mattavalkoinen tai mattamusta, akryyli ·
 metal, biały mat lub czarny mat, akryl

Pendelleuchte · Pendant
 Ø 50 cm, ↑ 150 cm
 excl. 3 x E27, max. 25 W



303500331
 303500332

Empfohlen:
 recommended: LED E27, 7 W
 560 lm, 3.000 K



988-700





Dimmbar · Dimmable

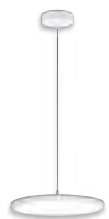

Pendelleuchte · Pendant
 ↑ 150 cm, Ø 40 cm
 incl. SMD-LED, 29 W
 3.750 lm, 4.000 K



340910131



Pendelleuchte · Pendant
 ↑ 150 cm, ↔ 90 x 17 cm
 incl. 3 x SMD-LED, 10 W
 3 x 1.250 lm, 4.000 K



340910331



Deckenleuchte · Ceiling lamp
 Ø 40 cm, ↑ 12 cm
 incl. SMD-LED, 29 W
 3.750 lm, 4.000 K



640910131



Kippbar · Tilttable



TRAY

Metall, weiß matt oder schwarz matt · metal, white mat or black mat ·
 metale, blanc mat ou noir mat · metaal, wit mat of mat zwart ·
 metal, estera blanca o estera negra · metallo, bianco
 opaco o nero opaco · metal, alb mat sau negru mat ·
 metalli, valkoinen matto tai musta matto · metal, biały
 mat lub czarny mat · metal, beyaz mat veya siyah mat



31 | Weiß matt · white mat



32 | Schwarz matt · black mat



Pendelleuchte · Pendant
 ↓ 150 cm, Ø 40 cm
 incl. SMD-LED, 29 W
 3.550 lm, 3.000 K



340910132



Pendelleuchte · Pendant
 ↓ 150 cm, ↔ 90 x 17 cm
 incl. 3 x SMD-LED, 10 W
 3 x 1.200 lm, 3.000 K



340910332



Deckenleuchte · Ceiling lamp
 Ø 40 cm, ↓ 12 cm
 incl. SMD-LED, 29 W
 3.750 lm, 3.000 K



640910132



FILO

Metall Schwarz matt, Glas Weiß · metal black mat, glass white ·
 metale noir mat, verre blanc · metaal mat zwart, glas wit · metal estera negra, vidrio blanco ·
 metallo nero opaco, vetro bianco · metal negru mat, sticla alb · metalli mattamusta, lasi valkoinen ·
 metal czarny mat, szkło biały



Pendelleuchte · Pendant
 ↓ 150 cm, Ø 40 cm
 excl. 1 x E27, max. 60 W



313900132



Pendelleuchte · Pendant
 ↔ 100 x 40 cm, ↓ 150 cm
 excl. 2 x E27, max. 60 W



313900232



Stehleuchte · Floor lamp
 ↓ 150 cm, ↔ 57,5 cm, Ø 40 cm
 excl. 1 x E27, max. 60 W



413900132







TAMIL

Metall oder Metall / Holz naturbelassen · metal or metal / wood natural finish ·
 métal ou métal / bois finition naturelle · metaal of metaal / hout natuurlijke afwerking ·
 metal o metal / madera acabado natural · metallo o metallo / di legno finitura naturale ·
 metal sau metal / lemn finisaj natural · metalli tai metalli / puu luonnollinen viimeistely ·
 metal lub metal / drewno naturalne wykończenie



08 | Messing matt · brass mat



67 | Nickel antik · nickel antique

Empfohlen:
 recommended: Filament LED E27, 4,5 W
 470 lm, 2.700 K



987-400



Deckenleuchte · Ceiling lamp
 Ø 50 cm, ↓ 22,5 cm
 excl. 3 x E27, max. 40 W



611100308
 611100367



Pendelleuchte · Pendant
 ↓ 150 cm, Ø 50 cm
 excl. 3 x E27, max. 40 W



311100308
 311100367





DISCALGO

Metall, Kunststoff · metal, plastic ·
 metale, plastique · metaal, kunststof · metal, plástico ·
 metallo, plastica · metal, plastic · metalli, muovi · metal, plastik



31 | Weiß matt · white mat



32 | Schwarz matt · black mat



Deckenleuchte · Ceiling lamp
 Ø 54 cm, ↓ 30 cm
 excl. 3 x E14, max. 40 W



609900331
 609900332



Pendelleuchte · Pendant
 Ø 54 cm, ↓ 150 cm
 excl. 6 x E14, max. 40 W



309900631
 309900632







ROXIE

Metall, Schwarz matt, goldfarbig · metal, black mat, gold ·
 métal, noir mat, or · metaal, mat zwart, goud · metal, estera negra, oro ·
 metallo, nero opaco, oro · metal, negru mat, aur · metalli, mattamusta, kultaa ·
 metal, czarny mat, złota



Pendelleuchte · Pendant
 ↓ 150 cm, ↔ 115 x 66 cm
 excl. 7 x E14, max. 40 W



311900632



Pendelleuchte · Pendant
 ↓ 150 cm, Ø 60 cm
 excl. 6 x E14, max. 40 W



311900732



Tischleuchte · Table lamp
 ↓ 43 cm, ↔ 17 cm, ∅ 25,5 cm
 excl. 1 x E14, max. 40 W



511900132



Stehleuchte · Floor lamp
 ↓ 155 cm, ↔ 43 cm, ∅ 23 cm
 excl. 2 x E14, max. 40 W



411900232

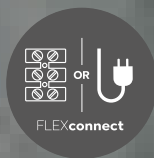

Seite/page 632

ROXIE

Metall, Schwarz matt, goldfarbig · metal, black mat, gold ·
 métal, noir mat, or · metaal, mat zwart, goud · metal, estera negra, oro ·
 metallo, nero opaco, oro · metal, negru mat, aur · metalli, mattamusta, kultaa ·
 metal, czarny mat, złota



Strahler · Spot

↑ 22,7 cm, ↔ 10 cm, ↗ 15,7 cm
 excl. 1 x E14, max. 40 W



811900132



Strahler · Spot

↔ 40 x 13,8 cm, ↓ 22,8 cm
 excl. 2 x E14, max. 40 W



811900232



Strahler · Spot

↔ 60 x 13,8 cm, ↓ 22,8 cm
 excl. 3 x E14, max. 40 W



811900332

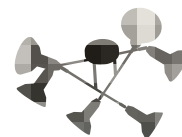

Deckenleuchte · Ceiling lamp

Ø 66 cm, ↓ 33 cm
 excl. 6 x E14, max. 40 W



611900632





Pendelleuchte · Pendant
 Ø 54,5 cm, † 150 cm
 excl. 6 x E27, max. 28 W



306700632
306700602 | Schwarz · black

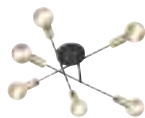

Deckenleuchte · Ceiling lamp
 Ø 56,6 cm, † 19,1 cm
 excl. 6 x E27, max. 40 W



606700632



Stehleuchte · Floor lamp
 † 165 cm, Ø 54,5 cm
 excl. 6 x E27, max. 28 W



406700632





CROSS

Metall, Schwarz matt / goldfarbig · metal, black mat / gold ·
 metale, noir mat / or · metaal, mat zwart / goud ·
 metal, estera negra / oro · metallo, nero opaco / oro ·
 metal, negru mat / aur · metalli, musta matto / kultaa ·
 metal, czarny mat / złota

Empfohlen:
 recommended: Filament LED E27, 6 W
 660 lm, 2.700 K



988-679



Pendelleuchte · Pendant
 ↔ 91 x 45 cm, ↓ 150 cm
 excl. 7 x E27, max. 28 W



306700732



BELA

Metall, Schwarz matt / goldfarbig · metal, black mat / gold ·
 metale, noir mat / or · metaal, mat zwart / goud ·
 metal, estera negra / oro · metallo, nero opaco / oro ·
 metal, negru mat / aur · metalli, musta matto / kultaa ·
 metal, czarny mat / złota

Empfohlen:
 recommended: Filament LED E27, 8 W
 700 lm, 2.700 K



987-6700



Stehleuchte · Floor lamp
 ↓ 140,5 cm, ↔ 23 x 16 cm
 excl. 3 x E27, max. 10 W



407900332

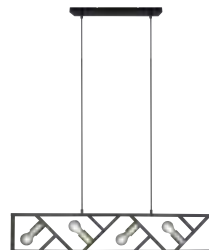

Pendelleuchte · Pendant
 ↔ 105 x 8,5 cm, ↓ 150 cm
 excl. 4 x E27, max. 10 W



307900432





RUSTICA

Metall, rostfarbig, Glas matt · metal, rusty, mat glass ·
 metale, rouille, verre mat · metaal, roestkleur, mat glas ·
 metal, óxido, vidrio mate · metallo, ruggine, vetro sabbaiato ·
 metal, ruginiu, sticla mata · metalli, rustiikki, mattalasi ·
 metal, miedź, szkło matowane



Deckenleuchte · Ceiling lamp
 Ø 55 cm, ↓ 42,5 cm
 excl. 3 x E27, max. 40 W



601000324



Pendelleuchte · Pendant
 ↓ 150 cm, Ø 55 cm
 excl. 3 x E27, max. 40 W



101000324



Pendelleuchte · Pendant
 ↓ 150 cm, Ø 60 cm
 excl. 5 x E27, max. 40 W



101000524





RUSTICA

Metall, rostfarbig, Glas matt · metal, rusty, mat glass ·
 metale, rouille, verre mat · metaal, roestkleur, mat glas ·
 metal, óxido, vidrio mate · metallo, ruggine, vetro sabbiato ·
 metal, ruginiu, sticla mata · metalli, rustiikki, mattalasi ·
 metal, miedź, szkło matowane



Deckenleuchte · Ceiling lamp
 Ø 38 cm, ↑ 16,5 cm
 excl. 2 x E27, max. 60 W



6102021-24



Tischleuchte · Table lamp
 ↑ 50 cm, Ø 31 cm
 excl. 2 x E14, max. 40 W



501000224



Stehleuchte · Floor lamp
 ↑ 180 cm, Ø 33,5 cm
 excl. 2 x E27, max. 60 W



401000224



Stehleuchte · Floor lamp
 ↑ 180 cm, Ø 32,5 cm
 excl. 1 x E27, max. 100 W
 excl. 1 x E14, max. 40 W



4602021-24

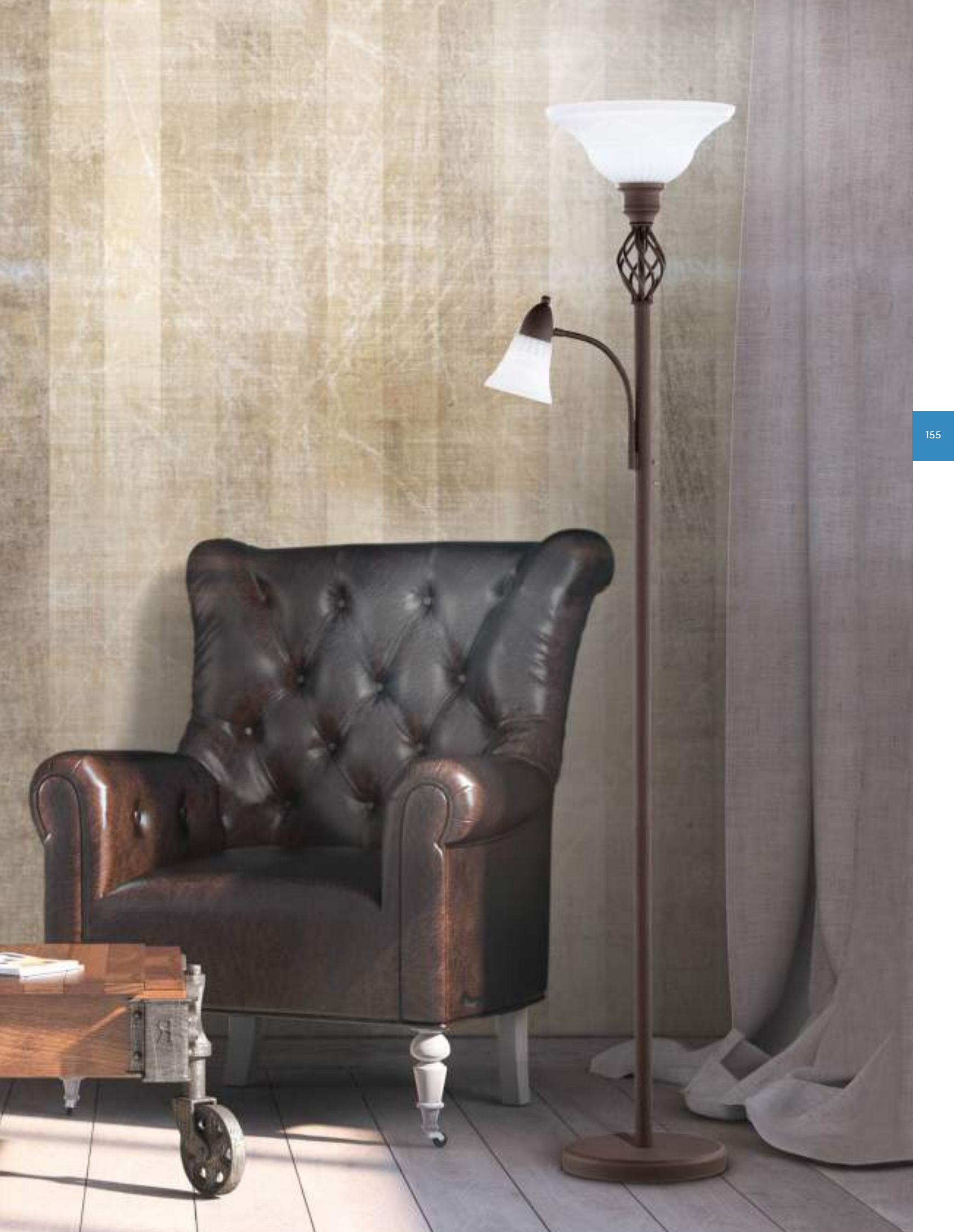



NAPOLI

Metall, rostfarbig antik mit Acrylapplikationen ·
 metal, antique rust with acrylic decoration ·
 métal, rouille antique avec décoration acrylique ·
 Metaal, roestkleur antiek met acryl decoraties ·
 Metal, oxido con decoración en acrílico ·
 metallo, ruggine anticato con decorazione in acrilico ·
 metal, ruginiu antic cu decoratie acrilica ·
 metaalia, rustiikki jossa akryyli koristeet ·
 Metal, antyczny rdzawy z aplikacjami akrylowym

Empfohlen:
 recommended: Filament LED E14, 4 W
 470 lm, 2.700 K



989-400



Deckenleuchte · Ceiling lamp
 Ø 50 cm, ↓ 50 cm
 excl. 4 x E14, max. 28 W



610300428



Pendelleuchte · Pendant
 Ø 52 cm, ↓ 150 cm
 excl. 4 x E14, max. 28 W



110300428





Pendelleuchte · Pendant
 Ø 70 cm, † 150 cm
 excl. 3 x E14, max. 40 W



110700328



Pendelleuchte · Pendant
 Ø 70 cm, † 150 cm
 excl. 5 x E14, max. 40 W



110700528



Deckenleuchte · Ceiling lamp
 Ø 61 cm, † 26 cm
 excl. 3 x E14, max. 40 W



600700328





TRADITIO

Metall, Glas alabasterfarbig · metal, alabaster-coloured glass ·
 metale, verre couleur albâtre · metaal, albastkleurig glas ·
 metal, vidrio de color alabastro · metallo, vetro colore alabastro ·
 metal, sticla culoare alabastru · metalli, lasi alabasteri väri ·
 metal, szkło alabaster kolor

Empfohlen:
 recommended: LED E14, 3,5 W
 320 lm, 3.000 K



983-40



Wandleuchte · Wall lamp
 ↔ 12 x 21,5 cm, ∅ 29 cm
 excl. 1 x E14, max. 40 W



200700128



Tischleuchte · Table lamp
 ↓ 32 x 16 cm, ∅ 27 cm
 excl. 1 x E14, max. 40 W



500700128



Seite/page 632



Wandleuchte · Wall lamp
 ↑ 15 x 10 cm, ↗ 20 cm
 excl. 1 x E27, max. 42 W



208070131
208070132



Deckenleuchte · Ceiling lamp
 Ø 47 cm, ↑ 16,5 cm
 excl. 3 x E27, max. 42 W



608000331
608000332

Empfohlen:
 recommended: Filament LED E27, 7 W
 806 lm, 3.000 K



988-600

Filament LED E27, 6 W
 660 lm, 2.700 K



988-679





DIALLO

Metall, Weiß matt oder Schwarz matt · metal, white mat or black mat ·
 metale, blanc mat ou noir mat · metaal, wit mat of mat zwart ·
 metal, estera blanca o estera negra · metallo, bianco opaco o nero opaco ·
 metal, alb mat sau negru mat · metalli, valkoinen matto tai musta matto ·
 metal, biały mat lub czarny mat

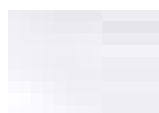

31 | Weiß matt · white mat

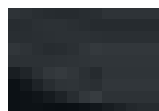

32 | Schwarz matt · black mat



Tischleuchte · Table lamp
 ↑ 51 cm, ↔ 15 cm, ↗ 23,5 cm
 excl. 1 x E27, max. 42 W



508000131
 508000132



Stehleuchte · Floor lamp
 ↑ 149 cm, ↔ 23 cm, ↗ 39,3 cm
 excl. 1 x E27, max. 42 W



408000131
 408000132



FLETCHER

Metall · metal ·
metale · metaal · metal ·
metallo · metal · metalli · metal

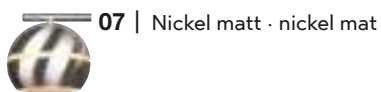

07 | Nickel matt · nickel mat



08 | Messing matt / Schwarz matt ·
brass mat / black mat



32 | Schwarz matt · black mat



Tischleuchte · Table lamp
↓ 42,5 cm, ↔ 15 cm, ↗ 31 cm
excl. 1 x E14, max. 10 W



593400107
593400108
593400132



Stehleuchte · Floor lamp
↓ 143 cm, ↔ 23 cm, ↗ 42 cm
excl. 1 x E14, max. 10 W



413300107
413300108
413300132



Pendelleuchte · Pendant
↔ 75 x 15 cm, ↓ 150 cm
excl. 3 x E14, max. 40 W



313300307
313300308
313300332

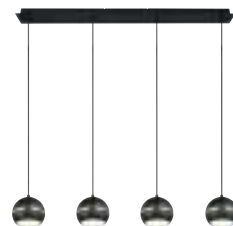

Pendelleuchte · Pendant
↔ 105 x 15 cm, ↓ 150 cm
excl. 4 x E14, max. 40 W



313300407
313300408
313300432







JASPER

Metall, Altmessing · metal, old brass ·
 métal, laiton fumé · metaal, oud brons · metal, bronce viejo ·
 metallo, ottone invecchiato · metal, bronz antic · metalli, antiikkimessinki ·
 metal, patyna

Empfohlen:
 recommended: LED E27, 4,9 W
 470 lm, 3.000 K



987-60

LED E14, 5 W
 400 lm, 3.000 K



989-60



Pendelleuchte · Pendant
 Ø 31 cm, ↓ 150 cm
 excl. 1 x E27, max. 60 W



300500104



Tischleuchte · Table lamp
 ↓ 45 cm, ↔ 15 cm, ↗ 23 cm
 excl. 1 x E14, max. 18 W



500500104



Stehleuchte · Floor lamp
 ↓ 140 cm, ↔ 23 cm, ↗ 52 cm
 excl. 1 x E14, max. 18 W



400500104

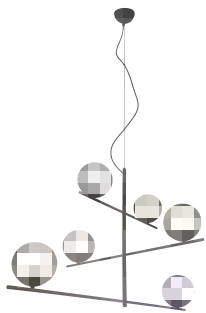

Pendelleuchte · Pendant
↑ 150 cm, Ø 115 cm
excl. 6 x E14, max. 28 W



302000632
302000642



Empfohlen:
recommended: LED E14, 3,5 W
320 lm, 3.000 K



983-40

LED E14, 4 W
470 lm, 2.700 K



983-400

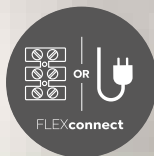

Seite/page 632

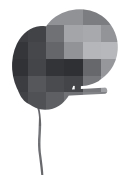

Wandleuchte · Wall lamp
↑ 20,6 cm, ↗ 21,3 cm
excl. 1 x E14, max. 28 W



202000132
202000142



Tischleuchte · Table lamp
↑ 52 cm, ↔ 18 cm, ↗ 24,2 cm
excl. 1 x E14, max. 28 W



502000132
502000142



PURE

Metall, Glas · metal, glass ·
 metale, verre · metaal, glas · metal, vidrio ·
 metallo, vetro · metal, sticla · metalli, lasi · metal, szkło



32 | Schwarz matt, Glas Weiß ·
 black mat, glass white



42 | Anthazit, Rauchglas ·
 anthracite, smoked glass



Pendelleuchte · Pendant
 ↓ 150 cm, Ø 40 cm
 excl. 3 x E14, max. 28 W



302000332
 302000342



Stehleuchte · Floor lamp
 ↓ 150 cm, ↔ 25 cm, ↗ 31,7 cm
 excl. 1 x E14, max. 28 W



402000132
 402000142

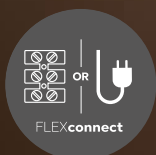

Seite/page 632

PURE

Messing matt, Glas Weiß · brass mat, glass white ·
 laiton mat, verre blanc · messing mat, glas wit · bronze mate, vidrio blanco ·
 ottone satinato, vetro bianco · bronz mat,
 sticla alb · mattamessinki, lasi valkoinen ·
 mosiądz mat, szkło biały



Wandleuchte · Wall lamp
 ↑ 20,6 cm, ↗ 21,3 cm
 excl. 1 x E14, max. 28 W



202000108



Pendelleuchte · Pendant
 ↑ 150 cm, Ø 40 cm
 excl. 3 x E14, max. 28 W



302000308

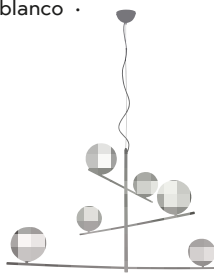

Pendelleuchte · Pendant
 ↑ 150 cm, Ø 115 cm
 excl. 6 x E14, max. 28 W



302000608



Tischleuchte · Table lamp
 ↑ 52 cm, ↔ 18 cm, ↗ 24,2 cm
 excl. 1 x E14, max. 28 W



502000108



Stehleuchte · Floor lamp
 ↑ 150 cm, ↔ 25 cm, ↗ 31,7 cm
 excl. 1 x E14, max. 28 W



402000108





BALINI

Metall, Anthrazit, Rauchglas · metal, anthracite, smoked glass ·
 métal, anthracite, verre fumé · metaal, antraciet, rookglas ·
 metal, antracita, vidrio ahumado · metallo, antracite,
 vetro fume' · metal, antracit, sticla fumurie · metalli,
 antrasiitti, savulasi · metal, antracyt, szkło przydymione



Pendelleuchte · Pendant
 Ø 30 cm, ↓ 150 cm
 excl. 3 x E14, max. 28 W



308590342



Pendelleuchte · Pendant
 ↔ 100 x 16 cm, ↓ 150 cm
 excl. 5 x E14, max. 28 W



308500542



Stehleuchte · Floor lamp
 ↓ 180 cm, ↔ 30 cm, ↗ 85 cm
 excl. 5 x E14, max. 28 W



408500542

Empfohlen:
 recommended: Filament LED E14, 4 W
 470 lm, 3.000 K



983-400





Deckenleuchte · Ceiling lamp
 Ø 45 cm, ↓ 46,5 cm
 excl. 12 x G9, max. 10 W



607601206



Pendelleuchte · Pendant
 ↓ 150 cm, Ø 45 cm
 excl. 12 x G9, max. 10 W



307601206



ALICIA

Chrom, Glas rauchfarbig · chrome, glass smoke ·
 chrome, verre fumé · chroom, glas rookkleur ·
 cromo, vidrio humo · cromo, vetro fume' ·
 crom, sticla fumuriu · kromi, lasi savu ·
 chrom, szkło przydymiony

Empfohlen:

recommended: LED G9, 3 W
 300 lm, 3.000 K



929-2300



Tischleuchte · Table lamp
 ↓ 52 cm, Ø 23 cm
 excl. 6 x G9, max. 5 W



507690606



Stehleuchte · Floor lamp
 ↓ 155 cm, Ø 25 cm
 excl. 9 x G9, max. 5 W



407690906





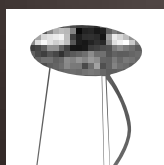

Deckenleuchte · Ceiling lamp
 Ø 40 cm, ↑ 22 cm
 excl. 5 x G9, max. 42 W



611210506

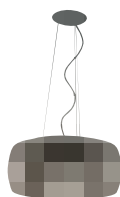

Pendelleuchte · Pendant
 Ø 50 cm, ↑ 150 cm
 excl. 6 x G9, max. 42 W



311210606



Tischleuchte · Table lamp
 Ø 28 cm, ↑ 43 cm
 excl. 3 x G9, max. 42 W



511210306





VAPORE

Chrom, Glas chrom bedampft · chrome, chroom plated glass ·
 chrome, verre plaqué chrome · chroom, chroom opgedampt glas ·
 cromo, vidrio cromado · cromo, vetro verniciato cromo ·
 crom, sticla cromata · kromi, kromipäällystetty lasi ·
 chrom, szkło chromowane

Empfohlen:
 recommended: LED G9, 3 W
 300 lm, 3.000 K



929-2300



Pendelleuchte · Pendant
 Ø 40 cm, ↓ 150 cm
 excl. 5 x G9, max. 42 W



311210506



Stehleuchte · Floor lamp
 Ø 40 cm, ↓ 158 cm
 excl. 4 x G9, max. 42 W



411210406

LORENA

Metall, Schwarz matt, Glas chrom bedampft · metal, black mat, chrome plated glass ·
 métal, noir mat, verre plaqué chrome · metaal, mat zwart, chroom opgedampt glas ·
 metal, estera negra, vidrio cromado · metallo, nero opaco, vetro verniciato cromo ·
 metal, negru mat, sticla cromata · metalli, mattamusta, kromipäällystetty lasi ·
 metal, czarny mat, szkło chromowane



Deckenleuchte · Ceiling lamp
 Ø 28,5 cm, ↓ 32 cm
 excl. 1 x E27, max. 40 W



615190132



Pendelleuchte · Pendant
 ↓ 150 cm, Ø 41 cm
 excl. 1 x E27, max. 40 W



315190132



Tischleuchte · Table lamp
 ↓ 30 cm, Ø 28,5 cm
 excl. 1 x E27, max. 40 W



515190132

Empfohlen:

recommended: Filament LED E27, 4 W
 470 lm, 2.700 K



987-400





VALENTE

Metall, Glas · metal, glass ·
metale, verre · metaal, glas · metal, vidrio ·
metallo, vetro · metal, sticla · metalli, lasi · metal, szkło

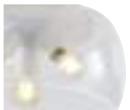

31 | Weiß matt, Glas klar · white mat, clear glass



42 | Anthrazit, Rauchglas · anthracite smoked glass



Deckenleuchte · Ceiling lamp
Ø 40 cm, ↓ 25 cm
excl. 3 x E27, max. 60 W



600600331
600600342



Pendelleuchte · Pendant
Ø 40 cm, ↓ 150 cm
excl. 3 x E27, max. 60 W



300600331
300600342





Pendelleuchte · Pendant
 ↓ 150 cm, Ø 10 cm
 excl. 1 x E27, max. 28 W



- 310600101
- 310600132
- 310600154



Pendelleuchte · Pendant
 ↓ 150 cm, Ø 37 cm
 excl. 3 x E27, max. 28 W



- 310630301
- 310630332
- 310630354

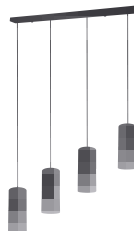

Pendelleuchte · Pendant
 ↓ 150 cm, ↔ 80,5 cm
 excl. 4 x E27, max. 28 W



- 310600401
- 310600432
- 310600454



Tischleuchte · Table lamp
 ↓ 25,5 cm, Ø 11 cm
 excl. 1 x E27, max. 28 W



- 510600101
- 510600132
- 510600154



ROBIN

Metall, Glas · metal, glass ·
 metale, verre · metaal, glas · metal, vidrio ·
 metallo, vetro · metal, sticla · metalli, lasi · metal, szkło

01 | Schwarz matt, Glas weiß · black mat, glass white

32 | Schwarz matt, Glas rauchfarbig · black mat, glass smoke

54 | Messing matt, Glas rauchfarbig · brass mat, glass smoke



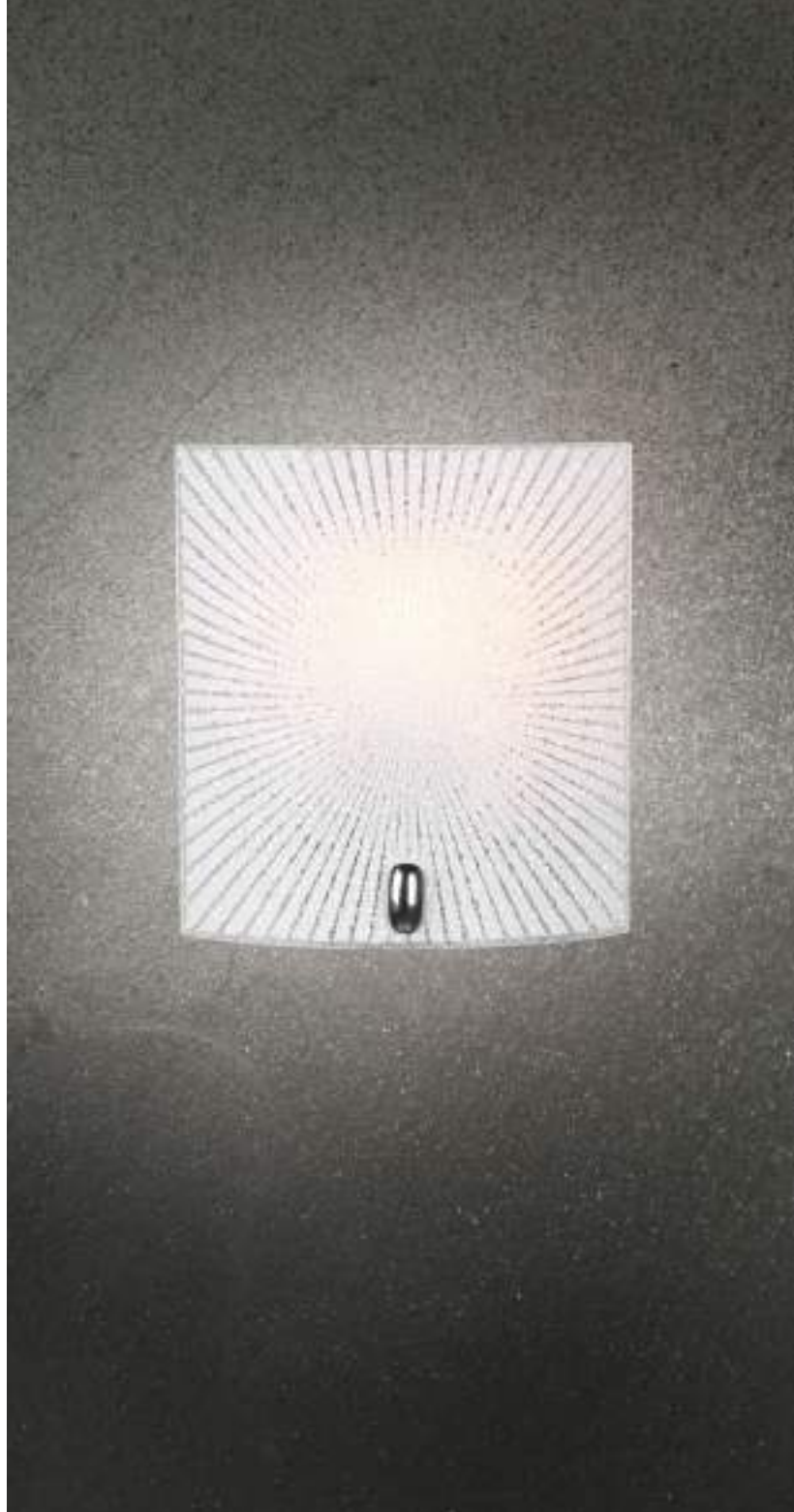
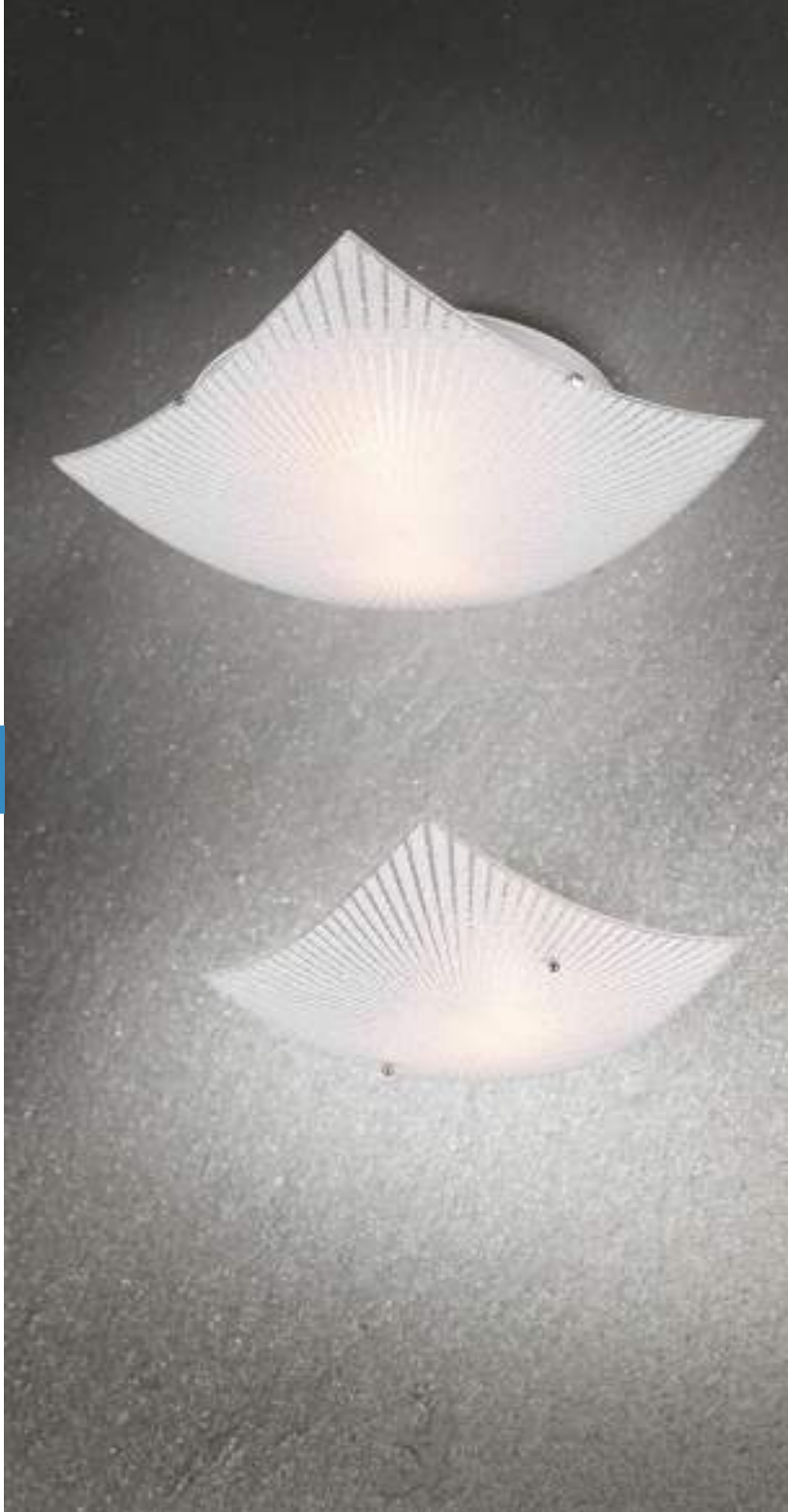

Deckenleuchte · Ceiling lamp
↔ 40 x 40 cm, ↓ 9,5 cm
excl. 2 x E27, max. 40 W



612200200



Deckenleuchte · Ceiling lamp
↔ 30 x 30 cm, ↓ 9 cm
excl. 1 x E27, max. 40 W



612200100



Wandleuchte · Wall lamp
↓ 22 cm, ↔ 20 cm, ↗ 8,5 cm
excl. 1 x E27, max. 40 W



212200100



Pendelleuchte · Pendant
↓ 150 cm, ↔ 40 x 20 cm
excl. 2 x E27, max. 40 W



312200200



ELISA

Metall, Glas · metal, glass ·
 métal, verre · metaal, glas · metal, vidrio ·
 metallo, vetro · metal, sticla · metalli, lasi · metal, szkło

Empfohlen:
 recommended: Filament LED E27, 4 W
 470 lm, 2.700 K



987-400





Deckenleuchte · Ceiling lamp
↔ 30 x 30 cm, ↓ 9 cm
excl. 1 x E27, max. 40 W



604400101



Deckenleuchte · Ceiling lamp
↔ 40 x 40 cm, ↓ 9,5 cm
excl. 2 x E27, max. 40 W



604400201



Deckenleuchte · Ceiling lamp
↔ 50 x 50 cm, ↓ 11 cm
excl. 3 x E27, max. 40 W



604400301

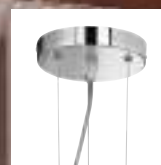

SPIRELLI

Chrom, Dekorglas Weiß · chrome, glas decorated white ·
 chrome, verre décoré blanc · chrom, decoratief glas wit · cromo, vidrio decorado blanco ·
 cromo, vetro decorato bianco · crom, sticla decorativa alb · kromi, ornamenttilasi valkoinen ·
 chrom, szkło dekoracyjne biały



Wandleuchte · Wall lamp
 ↔ 30 x 22 cm, ↕ 7,5 cm
 excl. 1 x E27, max. 40 W



204400101



Pendelleuchte · Pendant
 ↔ 40 x 20 cm, ↓ 150 cm
 excl. 2 x E27, max. 40 W



304400201



Wandleuchte · Wall lamp

↔ 30 x 22 cm, ↗ 7,5 cm
excl. 1 x E27, max. 40 W



208700179 | goldfarbig · gold

208700189 | silberfarbig · silver



Deckenleuchte · Ceiling lamp

↔ 30 x 30 cm, ↓ 9 cm
excl. 1 x E27, max. 40 W



608700189



Deckenleuchte · Ceiling lamp

↔ 40 x 40 cm, ↓ 9,5 cm
excl. 2 x E27, max. 40 W



608700289

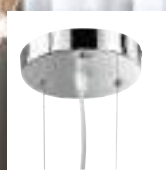

NIKOSIA

Dekorglas · glas decorated · verre décoré · decoratief glas · vidrio decorado · vetro decorato · sticla decorativa · ornamenttilasi · szkło dekoracyjne



Pendelleuchte · Pendant
 Ø 14 cm, ↓ 150 cm
 excl. 1 x E27, max. 40 W



308700189



Pendelleuchte · Pendant
 ↔ 50 x 20 cm, ↓ 150 cm
 excl. 2 x E27, max. 40 W



308700289



SANDRINA

Dekorglas · glas decorated ·
verre décoré · decoratief glas · vidrio decorado ·
vetro decorato · sticla decorativa · ornamentilasi · szkło dekoracyjne



Wandleuchte · Wall lamp
↔ 30 x 15 cm, ↯ 8 cm
excl. 1 x E27, max. 40 W



201200100



Deckenleuchte · Ceiling lamp
Ø 30 cm, ↯ 9 cm
excl. 1 x E27, max. 40 W



601200100



Deckenleuchte · Ceiling lamp
Ø 40 cm, ↯ 10 cm
excl. 2 x E27, max. 40 W



601200200



Pendelleuchte · Pendant
Ø 50 cm, ↯ 150 cm
excl. 3 x E27, max. 40 W



301200300



SIGNA

Chrom, Dekorglas Weiß · chrome, glas decorated white ·
 chrome, verre décoré blanc · chroom, decoratief glas wit ·
 cromo, vidrio decorado blanco · cromo, vetro decorato bianco ·
 crom, sticla decorativa alb · kromi, ornamenttilasi valkoinen ·
 chrom, szkło dekoracyjne biały



Wandleuchte · Wall lamp
 ↔ 20 x 30 cm, ↕ 9 cm
 excl. 1 x E27, max. 40 W



202500101



Deckenleuchte · Ceiling lamp
 ↔ 30 x 30 cm, ↕ 9 cm
 excl. 1 x E27, max. 40 W



602500101



Deckenleuchte · Ceiling lamp
 ↔ 40 x 40 cm, ↕ 9,5 cm
 excl. 2 x E27, max. 40 W



602500201



Pendelleuchte · Pendant
 Ø 50 cm, ↕ 150 cm
 excl. 3 x E27, max. 40 W



302500301



SWEETY

Acryl · acryl ·
acryl · acryl · acrílico · acrílico ·
acrilic · akryyli · akryl



Wandleuchte · Wall lamp
↔ 20 x 20 cm, ↗ 9 cm
excl. 1 x E14, max. 40 W



207800100



Deckenleuchte · Ceiling lamp
Ø 30 cm, ↓ 10,5 cm
excl. 1 x E27, max. 60 W



607800100



Pendelleuchte · Pendant
Ø 30 cm, ↓ 150 cm
excl. 1 x E27, max. 60 W



307800100



Pendelleuchte · Pendant
Ø 40 cm, ↓ 150 cm
excl. 1 x E27, max. 60 W



307804100





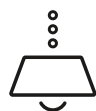

Pendelleuchten & Kronen

Pendants & chandeliers

Lustres & suspensions

Hanglampen & kroonluchters

Colgantes y Lámparas

Lampadari e sospensioni

Lustre si pendule

Riippu- & kruunu

Wiszące i żyrandole

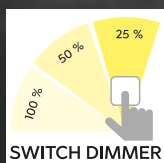

MADISON

Metall, Schwarz matt, Rauchglas · metal, black mat, smoked glass · métal, noir mat, verre fumé · metaal, mat zwart, rookglas · metal, estera negra, vidrio ahumado · metallo, nero opaco, vetro fumé · metal, negru mat, sticla fumurie · metalli, mattamusta, savulasi · metal, czarny mat, szkło przydymione

 Höhenverstellbar · Adjustable height

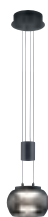

Pendelleuchte · Pendant
 ↑ 95 - 150 cm, Ø 18 cm
 incl. 1 x SMD-LED, 8 W
 900 lm, 3.000 K



342010132



Pendelleuchte · Pendant
 ↑ 95 - 150 cm, ↔ 52 cm, Ø 18 cm
 incl. 2 x SMD-LED, 8 W
 2 x 900 lm, 3.000 K



342010232



Pendelleuchte · Pendant
 ↑ 95 - 150 cm, ↔ 82 cm, Ø 18 cm
 incl. 3 x SMD-LED, 8 W
 3 x 900 lm, 3.000 K



342010332



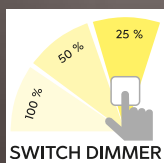

MADISON

Metall, Glas · metal, glass ·
metale, verre · metaal, glas · metal, vidrio ·
metallo, vetro · metal, sticla · metalli, lasi ·
metal, szkło

 Höhenverstellbar ·
Adjustable height

 **07** | Nickel matt · nickel mat

 **08** | Messing matt · brass mat



Pendelleuchte · Pendant
↑ 95 - 150 cm, Ø 18 cm
incl. 1 x SMD-LED, 8 W
900 lm, 3.000 K



342010107
342010108



Pendelleuchte · Pendant
↑ 95 - 150 cm, ↔ 52 cm, Ø 18 cm
incl. 2 x SMD-LED, 8 W
2 x 900 lm, 3.000 K



342010207
342010208



Pendelleuchte · Pendant
↑ 95 - 150 cm, ↔ 82 cm, Ø 18 cm
incl. 3 x SMD-LED, 8 W
3 x 900 lm, 3.000 K



342010307
342010308



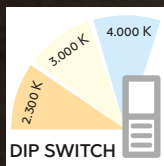

DIP SWITCH

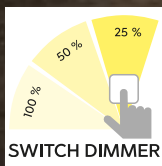

SWITCH DIMMER



DIP SWITCH

Lichtfarben direkt an der Leuchte einstellbar · Colours directly adjustable at the lamp ·
 Les couleurs de la lumière peuvent être réglées directement sur le luminaire ·
 Lichtkleuren direct instelbaar op de lamp · Tonalidades de luz ajustables directamente en la lámpara ·
 Colori della luce regolabili direttamente sulla lampada · Colori ale luminii reglabile direct de la bec ·
 Valon väri asetettävissa suoraan valaisimesta · Barwy światła można ustawić bezpośrednio na oprawie

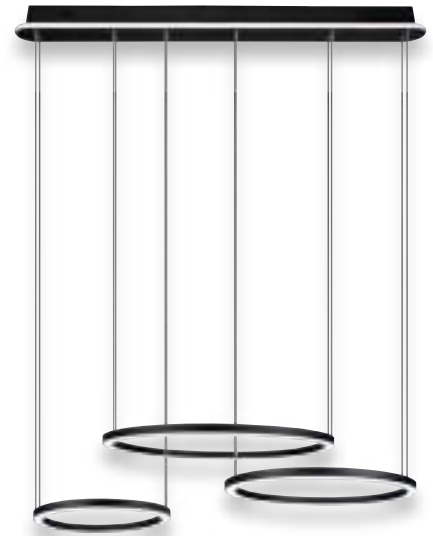



MORRISON

Metall, Acryl · metal, acryl ·
metale, acryl · metaal, acryl · metal, acrílico ·
metallo, acrilico · metal, acrilic · metalli, akryyli · metal, akryl



DIP SWITCH



SWITCH DIMMER



07 | Nickel matt · nickel mat



31 | Weiß matt · white mat



32 | Schwarz matt · black mat

Pendelleuchte · Pendant

↔ 90 x 50 cm, ↑ 150 cm

incl. SMD-LED, 56 W

6.800 lm, 2.300 + 3.000 + 4.000 K



323610307

323610331

323610332

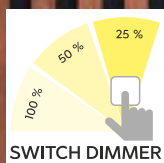

DURBAN

Metall, Nickel matt oder Anthrazit · metal, nickel mat or anthracite ·
 metale, nickel mat ou antracite · metaal, nikkell mat of antraciet ·
 metal, níquel mate o antracita · metallo, nichel opaco o antracite ·
 metal, nichel mat sau antracit · metalli, harjattu teräs tai antrasiitti ·
 metal, nikiel mat lub antracyt



07 | Nickel matt · nickel mat



42 | Anthrazit · anthracite



Pendelleuchte · Pendant
 Ø 60,3 cm, ↑ 200 cm
 incl. SMD-LED, 40 W
 5.000 lm, 3.000 K



321910207
 321910242



Pendelleuchte · Pendant
 Ø 80,3 cm, ↑ 200 cm
 incl. SMD-LED, 75 W
 8.000 lm, 3.000 K



321910307
 321910342



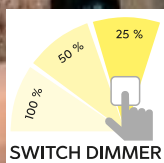

CURL

Metall, Weiß matt, Schwarz matt oder goldfarbig · metal, white mat, black mat or gold ·
 metale, blanc mat, noir mat ou or · metaal, wit mat, mat zwart of goud · metal, estera blanca, estera negra o oro · metallo, bianco opaco, nero opaco o oro ·
 metal, alb mat, negru mat sau aur · metalli, mattavalkoinen, mattamusta tai kultaa · metal, biały mat, czarny mat lub złota



31 | Weiß matt · white mat



32 | Schwarz matt · black mat



79 | goldfarbig · gold

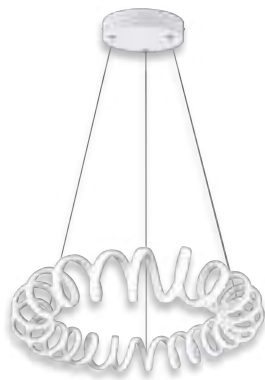

Pendelleuchte · Pendant
 Ø 55 cm, ↑ 150 cm
 incl. SMD-LED, 33 W
 5.000 lm, 3.000 K
 (31 = 5.000 lm, 4.000 K)



325110131
 325110132
 325110179

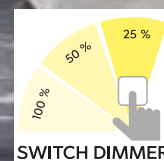

MACAU

Aluminium gebürstet · brushed aluminium ·
aluminium balayé · geborsteld aluminium · aluminio pulido ·
alluminio spazzolato · aluminiu lucios · harjattu alumiini ·
aluminium szczotkowane

Pendelleuchte · Pendant
Ø 75 cm, ↓ max. 200 cm
incl. SMD-LED, 64 W
6.000 lm, 3.000 K



325610305



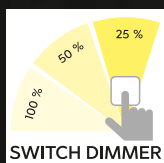

TUBULAR

Metall, Weiß matt oder Schwarz matt · metal, white mat or black mat ·
 metale, blanc mat ou noir mat · metaal, wit mat of mat zwart ·
 metal, estera blanca o estera negra · metallo, bianco opaco o nero opaco ·
 metal, alb mat sau negru mat · metalli, valkoinen matto tai musta matto ·
 metal, biały mat lub czarny mat



31 | Weiß matt · white mat

32 | Schwarz matt · black mat



Pendelleuchte · Pendant
 Ø 40 cm, ↓ 150 cm
 incl. 11 x SMD-LED, 2,8 W
 11 x 350 lm, 3.000 K



321691131
321691132

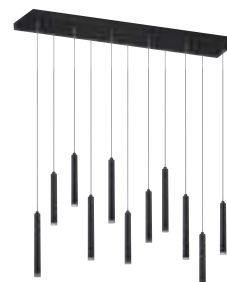

Pendelleuchte · Pendant
 ↔ 115 x 15 cm, ↓ 150 cm
 incl. 11 x SMD-LED, 2,8 W
 11 x 350 lm, 3.000 K



321611131
321611132





Pendelleuchte · Pendant
 ↔ 95 - 150 cm, ↓ 95 - 150 cm
 incl. SMD-LED, 45 W, 5.300 lm
 incl. 2 x SMD-LED, 6 W, 2 x 500 lm
 2.700 - 5.000 K



- 375310502
- 375310505
- 375310507
- 375310508
- 375310532

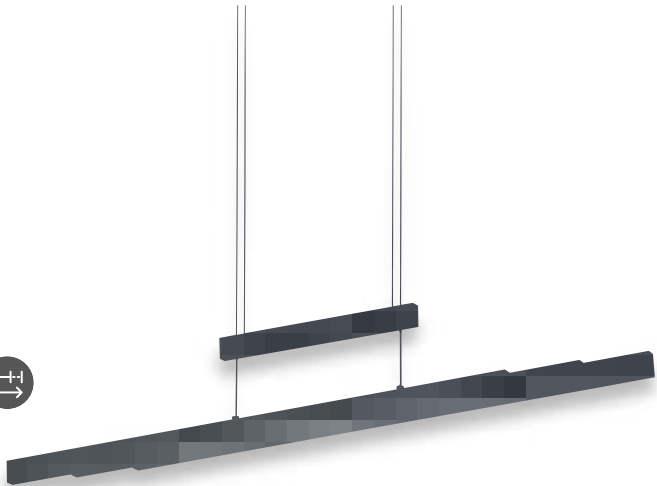

- 02** | Schwarz / Messing matt · black / brass mat
- 05** | Aluminium gebürstet · brushed aluminium
- 07** | Nickel matt · nickel mat
- 08** | Messing matt · brass mat
- 32** | Schwarz matt · black mat



TRAJAN

Metall · metal ·
metale · metaal · metal · metallo · metal · metalli · metal

 Lichtfarbe stufenlos einstellbar ·
Light color infinitely variable

 4 fach TOUCH ·
4 level Touch function

Ausziehbar · Extendible · extensible · Verlengbaar ·
Extensible · Estensibile · extensibil · Jatkettava · Rozsuwalny

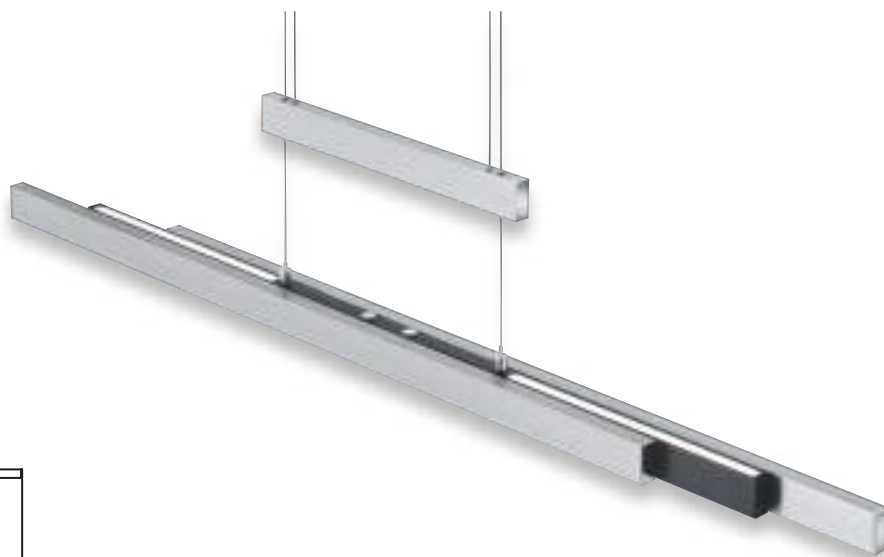
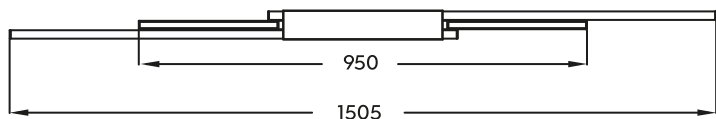

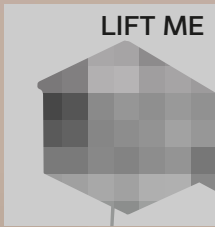

LIFT ME

Innovative Höhenverstellung ohne Gegengewicht ·
 Innovative height adjustment without counterweight ·
 Nouveau! Réglage de la hauteur sans contrepoids ·
 Innovatieve hoogterstelling zonder contragewicht ·
 Innovador sistema de ajuste de altura sin necesidad de contrapeso ·
 Regolazione innovativa dell'altezza senza contrappeso ·
 Ajustare inovativa a inaltimii fara contragreutate ·
 Innovatiivinen korkeuden säätö ilman vastapainoa ·
 Innowacyjna regulacja wysokości bez przeciwwagi

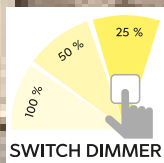

SWITCH DIMMER

ALEGRO

Nickel matt, Glas weiß · nickel mat, glass white ·
 nickel mat, verre blanc · nikkel mat, glas wit · níquel mate, vidrio blanco ·
 nichel opaco, vetro bianco · nichel mat, sticla alb · harjattu teräs, lasi valkoinen ·
 nikiel mat, szkło biały

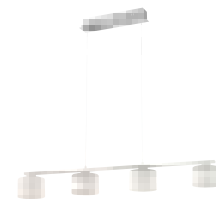

Pendelleuchte · Pendant
 ↔ 100 x 12 cm, ↑ 95 - 160 cm
 incl. 4 x SMD-LED, 6,5 W
 4 x 700 lm, 3.000 K



325510407

Pendelleuchte · Pendant
 ↔ 130 x 12 cm, ↑ 95 - 160 cm
 incl. 5 x SMD-LED, 6,5 W
 5 x 700 lm, 3.000 K



325510507



LACAL

Nickel matt oder goldfarbig · nickel mat or gold ·
 nickel mat ou or · nikkel mat of goud · níquel mate o oro ·
 nichel opaco o oro · nichel mat sau aur · harjattu teräs tai kultaa · nikiel mat lub złota

Gibt Licht nach oben und unten · up and down lighting ·
 point lumineux en haut et en bas · lichtpunt boven en onder · luz de arriba y abajo ·
 luce su e giù · sus și în jos lumina · ylös ja alas valoa · w górę iw dół światło

 Lichtfarbe einstellbar ·
 Adjustable light color

 4 fach TOUCH ·
 4 level Touch function



Pendelleuchte · Pendant

↔ 100 cm, ↓ 95 - 160 cm
 incl. 7 x SMD-LED, 4 W
 7 x 380 lm, 3.000 + 5.000 K



379190707 | Nickel matt · nickel mat

379190732 | Schwarz matt · black mat

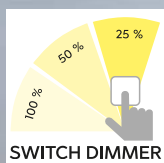

AICK

Metall, Aluminium gebürstet oder Schwarz matt · metal, brushed aluminium or black mat · metale, aluminium balayé ou noir mat · metaal, geborsteld aluminium of mat zwart · metal, aluminio pulido o estera negra · metallo, alluminio spazzolato o nero opaco · metal, aluminiu lucios sau negru mat · metalli, harjattu alumiini tai mattamusta · metal, aluminium szczotkowane lub czarny mat

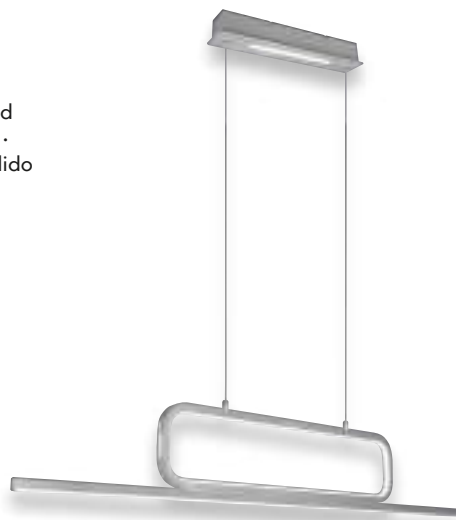

Pendelleuchte · Pendant

↔ 110 x 7,5 cm, ↑ 150 cm
incl. SMD-LED, 38 W
4.500 lm, 3.000 K



327210305 | Aluminium gebürstet ·
brushed aluminium

327210332 | Schwarz matt · black mat

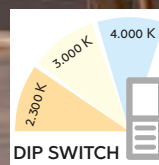

DIP SWITCH

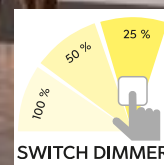

SWITCH DIMMER

GRANT

Aluminium gebürstet oder Messing matt, Schwarz matt ·
 brushed aluminium or brass mat, black mat · aluminium balayé
 ou laiton mat, noir mat · geborsteld aluminium of messing mat,
 mat zwart · aluminio pulido o bronce mate, estera negra ·
 lluminio spazzolato o ottone satinato, nero opaco · aluminu lucios
 sau bronz mat, negru mat · harjattu alumiini tai mattamessinki,
 mattamusta · aluminium szczotkowane lub mosiądz mat, czarny mat



05 | Aluminium gebürstet · brushed aluminium

08 | Messing matt · brass mat



Pendelleuchte · Pendant

↔ 138 x 12 cm, ↑ 150 cm
 incl. SMD-LED, 54 W
 6.500 lm, 2.300 + 3.000 + 4.000 K



342710205
 342710208



LUMINA

Metall, Schwarz matt, Glas chrom bedampft · Metal, black mat, chrome plated glass ·
 métal, noir mat, verre plaqué chrome · metaal, mat zwart, chroom opgedampt glas ·
 metal, estera negra, vidrio cromado · metallo, nero opaco, vetro verniciato cromo ·
 metal, negru mat, sticla cromata · metalli, mattamusta, kromipäällystetty lasi ·
 metal, czarny mat, szkło chromowane



Pendelleuchte · Pendant
 ↔ 60 x 6,5 cm, ↑ 150 cm
 excl. 3 x E14, max. 40 W



317000332



Pendelleuchte · Pendant
 ↔ 85 x 20 cm, ↑ 150 cm
 excl. 6 x E14, max. 40 W



317000632



Pendelleuchte · Pendant
 ↔ 115 x 20 cm, ↑ 150 cm
 excl. 8 x E14, max. 40 W



317000832

Empfohlen:

recommended: Filament LED E14, 4 W
 470 lm, 2.700 K



983-400





CLAYTON

Metall schwarz matt, Glas chrom bedampft · metal black mat, chrome plated glass ·
 métal noir mat, verre plaqué chrome · metaal mat zwart, chroom opgedampt glas ·
 metal estera negra, vidrio cromado · metallo nero opaco, vetro verniciato cromo ·
 metal negru mat, sticla cromata · metalli mattamusta, kromipäällystetty lasi ·
 metal czarny mat, szkło chromowane

Empfohlen:
 recommended: Filament LED E27, 4 W
 470 lm, 2.700 K



987-400



Pendelleuchte · Pendant
 Ø 20 cm, ↓ 150 cm
 excl. 1 x E27, max. 28 W



310300132

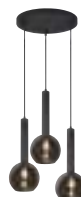

Pendelleuchte · Pendant
 Ø 45 cm, ↓ 150 cm
 excl. 3 x E27, max. 28 W



310390332



Pendelleuchte · Pendant
 ↔ 115 cm, ↓ 150 cm
 excl. 5 x E27, max. 28 W



310300532





MELA

Metall, Weiß matt oder Schwarz matt, Glas · metal, white mat or black mat, glass ·
 métal, blanc mat ou noir mat, verre · metaal, wit mat of mat zwart, glas ·
 metal, estera blanca o estera negra, vidrio · metallo, bianco opaco o nero opaco, vetro ·
 metal, alb mat sau negru mat, sticla · metalli, mattavalkoinen tai mattamusta, lasi ·
 metal, biały mat lub czarny mat, szkło

Empfohlen:
 recommended: Filament LED E14, 4 W
 470 lm, 2.700 K



983-400



31 | Weiß matt · white mat

32 | Schwarz matt · black mat



Pendelleuchte · Pendant
 Ø 33 cm, ↓ 150 cm
 excl. 5 x E14, max. 40 W



313100531
313100532

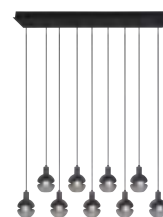

Pendelleuchte · Pendant
 ↔ 102 x 22 cm, ↓ 150 cm
 excl. 9 x E14, max. 40 W



313100931
313100932





Empfohlen:
recommended: Filament LED E27, 7 W
806 lm, 3.000 K



988-600

Filament LED E27, 6 W
660 lm, 2.700 K



988-679

CLERMONT

Metall · metal ·
metale · metaal · metal · metallo · metal · metalli · metal



07 | Nickel matt · nickel mat



31 | Weiß matt · white mat



32 | Schwarz matt · black mat



Pendelleuchte · Pendant
↓ 150 cm, Ø 10 cm
excl. 1 x E27, max. 10 W



313400107
313400131
313400132



Pendelleuchte · Pendant
↔ 70 x 9 cm, ↓ 150 cm
excl. 4 x E27, max. 10 W



313400407
313400431
313400432

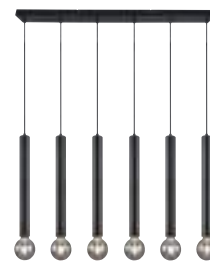

Pendelleuchte · Pendant
↔ 110 x 9 cm, ↓ 150 cm
excl. 6 x E27, max. 10 W



313400607
313400631
313400632





MARLEY

Metall · metal ·
metale · metaal · metal · metallo ·
metal · metalli · metal · metal

Empfohlen:
recommended: LED GU10, 4,5 W
345 lm, 3.000 K



956-55



01 | Weiß ·
white



07 | Nickel matt ·
nickel mat



31 | Weiß matt ·
white mat



32 | Schwarz matt ·
black mat



Pendelleuchte · Pendant
↓ 150 cm, ↔ 12 x 12 cm, Ø 6 cm
excl. 1 x GU10, max. 35 W



312400101
312400107
312400132

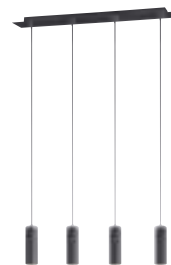

Pendelleuchte · Pendant
↔ 75 x 9 cm, ↓ 150 cm
excl. 4 x GU10, max. 35 W



312400401
312400407
312400432

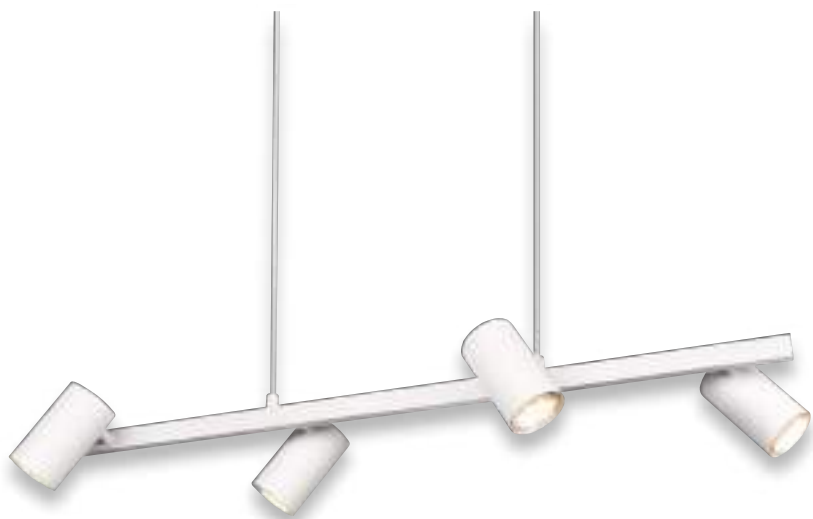

Pendelleuchte · Pendant
 ↔ 80 x 18 cm, ↓ 150 cm
 excl. 4 x GU10, max. 35 W



302400407
302400431
302400432



Pendelleuchte · Pendant
 ↔ 115 x 20 cm, ↓ 150 cm
 excl. 6 x GU10, max. 35 W



302400607
302400631
302400632



MARLEY

Metall, Altmessing oder Schwarz-Gold · metal, old brass or black-gold ·
 métal, laiton fumé ou noir et or · metaal, oud brons of zwart-goud ·
 metal, bronce viejo o negro-oro · metallo, ottone invecchiato o oro nero ·
 metal, bronz antic sau negru-auriu · metalli, antiikkimessinki tai musta-kulta ·
 metal, patyna lub czarno złoty

Empfohlen:
 recommended: LED GU10, 4,5 W
 345 lm, 3.000 K



956-55



04 | Altmessing ·
 old brass

80 | Schwarz-Gold ·
 black-gold

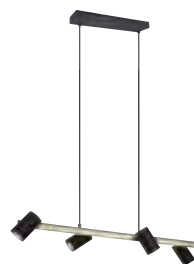

Pendelleuchte · Pendant
 ↔ 80 x 18 cm, ↑ 150 cm
 excl. 4 x GU10, max. 35 W



302400404
 302400480



Pendelleuchte · Pendant
 ↔ 115 x 20 cm, ↑ 150 cm
 excl. 6 x GU10, max. 35 W



302400604
 302400680



MARLEY

Metall, Holz · metal, wood ·
 Métal, bois · Metaal, hout · Metal, madera ·
 Metallo, di legno · Metal, lemn · Metalli, puu ·
 Metal, drewno

07 | Nickel matt / Holz ·
 nickel mat / wood

31 | Weiß matt / Holz ·
 white mat / wood

32 | Schwarz matt / Holz ·
 black mat / wood

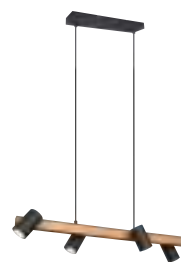
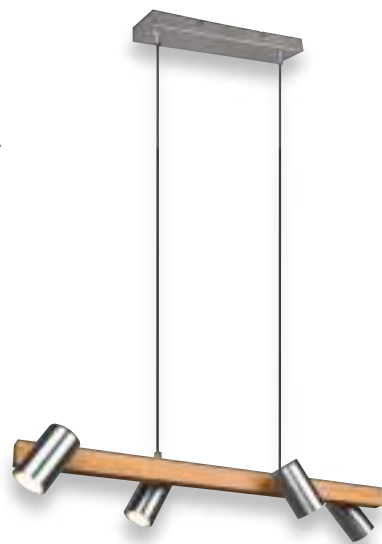

Pendelleuchte · Pendant
 ↔ 80 x 18 cm, ↓ 150 cm
 excl. 4 x GU10, max. 35 W



312490407
 312490431
 312490432



Pendelleuchte · Pendant
 ↔ 115 x 20 cm, ↓ 150 cm
 excl. 6 x GU10, max. 35 W



312490607
 312490631
 312490632



ONYX

Metall, Anthrazit, innen goldfarbig · metal, anthracite, gold colored inside ·
 metale, antracite, Or · metaal, antraciet, Binnenkant goudkleur ·
 metal, antracita, Interior en color dorado ·
 metallo, antracite, interno colore oro ·
 metal, antracit, interior culoare aurie ·
 metalli, antrasiitti, sisäosa kullanvärinen ·
 metal, antracyt, wewnątrz złoty



Pendelleuchte · Pendant
 Ø 15 cm, ↓ 150 cm
 excl. 1 x E27, max. 42 W



301300142



Pendelleuchte · Pendant
 Ø 35 cm, ↓ 150 cm
 excl. 3 x E27, max. 42 W



301300342



Pendelleuchte · Pendant
 ↔ 90 x 15 cm, ↓ 150 cm
 excl. 4 x E27, max. 42 W



301300442





CHIRON

Aluminium, Messing matt, Schwarz matt · aluminium, brass mat, black mat ·
 aluminium, laiton mat, noir mat · aluminium, messing mat, mat zwart ·
 aluminio, bronce mate, estera negra · alluminio, ottone satinato, nero opaco ·
 aluminiu, bronz mat, negru mat · alumiini, mattamessinki, mattamusta ·
 aluminium, mosiądz mat, czarny mat



Pendelleuchte · Pendant
 Ø 20 cm, ↓ 150 cm
 excl. 1 x E27, max. 40 W



310800108



Pendelleuchte · Pendant
 Ø 45 cm, ↓ 150 cm
 excl. 1 x E27, max. 40 W



310890108



Pendelleuchte · Pendant
 ↔ 90 x 20 cm, ↓ 150 cm
 excl. 3 x E27, max. 40 W



310800308



LIVIA

Metall Schwarz matt, goldfarbig · metal black mat, gold ·
 metale noir mat, or · metaal mat zwart, goud · metal estera negra, oro ·
 metallo nero opaco, oro · metal negro mat, aur · metalli musta matto, kultaa ·
 metal czarny mat, złota

Empfohlen:
 recommended: Filament LED E14, 4 W
 470 lm, 3.000 K



990-400



Pendelleuchte · Pendant
 Ø 46,8 cm, ↓ 150 cm
 excl. 3 x E14, max. 40 W



101700332



Pendelleuchte · Pendant
 Ø 57,5 cm, ↓ 150 cm
 excl. 5 x E14, max. 40 W



101700532



CORTEZ

Metall, Stoffschirm · metal, fabric shade ·
 metale, abat-jour tissu · metaal, Stoffen kap · metal, Pantalla de tela ·
 metallo, paralume in tessuto · metal, abajur textil · metalli, kangas varjostin ·
 metal, Klosz z materiału



31 | Weiß matt · white mat



78 | betonfarbig · concrete look



Pendelleuchte · Pendant
 Ø 52 cm, ↑ 150 cm
 excl. 3 x E14, max. 28 W



110600331
 110600378



Pendelleuchte · Pendant
 Ø 70 cm, ↑ 150 cm
 excl. 5 x E14, max. 28 W



110600531
 110600578



ELSA

Metall, Acryl · metal, acryl ·
metale, acryl · metaal, acryl · metal, acrílico ·
metallo, acrilico · metal, acrilic · metalli, akryyli · metal, akryl

Empfohlen:
recommended: Filament LED E14, 4 W
470 lm, 3.000 K



990-400



31 | Weiß matt · white mat

42 | Anthrazit · anthracite



Krone · Chandelier
Ø 56 cm, ↑ 150 cm
excl. 5 x E14, max. 40 W



112900531
112900542



Krone · Chandelier
Ø 72 cm, ↑ 150 cm
excl. 9 x E14, max. 40 W



112900931
112900942



ONTARIO

Glas goldfarbig oder kupferfarbig · glass gold or copper · Verre Or ou Cuivre · Glas Goud of Koperkleurig · Vidrio Oro o Color cobre · Vetro Oro o Colore rame · Sticla Aur sau Cupru · Lasi Kultaa tai Kuperinvärinen · Szkło Złota lub Kolorze miedzi



09 | kupferfarbig · copper

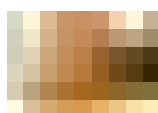

79 | goldfarbig · gold

Pendelleuchte · Pendant

↓ 155 cm, Ø 51 cm
excl. 1 x E27, max. 60 W



315200109
315200179



CONNOR

Metall, schwarz matt · metal, black mat ·
 Métal, Noir mat · Metaal, Mat zwart · Metal, Estera negra ·
 Metallo, Nero opaco · Metal, Negru mat · Metalli, mattamusta · Metal, Czarny mat

Empfohlen:
 recommended: Filament LED E27, 7 W
 806 lm, 3.000 K



988-600

Pendelleuchte · Pendant
 ↔ 126 x 40 cm, ↓ 150 cm
 excl. 8 x E27, max. 10 W



306200832



LUCERNA

Chrom, Acryl · chrome, acryl ·
 chrome, acryl · chroom, acryl · cromo, acrílico · cromo, acrilico ·
 crom, acrilic · kromi, akryyli · chrom, akryl



Wandleuchte · Wall lamp
 ↔ 33 x 22 cm, ↗ 19 cm
 excl. 2 x E14, max. 40 W



201600206



Lüster · Chandelier
 Ø 52 cm, ↑ 150 cm
 excl. 5 x E14, max. 40 W



101600506



Lüster · Chandelier
 Ø 68,5 cm, ↑ 150 cm
 excl. 8 x E14, max. 40 W



101600806

Empfohlen:
 recommended: Filament LED E14, 4 W
 470 lm, 3.000 K



990-400





CANDELA

Aluminium gebürstet/Chrom oder Messing matt/Messing poliert · brushed aluminium/chrome or brass mat/polished brass ·
 aluminium balayé/chrome ou laiton mat/laiton polis · geborsteld aluminium/chroom of messing mat/gepolijst messing ·
 aluminio pulido/cromo o bronce mate/bronce · alluminio spazzolato/cromo o ottone satinato/ottone lucido ·
 aluminiu lucios/crom sau bronz mat/bronz · harjattu alumiini/kromi tai mattamessinki/messinki ·
 aluminium szczotkowane/chrom lub miedz mat/mosiądz polerowany

Empfohlen:
 recommended: Filament LED E14, 4 W
 400 lm, 2.700 K



989-479



03 | Messing poliert · polished brass



05 | Aluminium gebürstet · brushed aluminium



Pendelleuchte · Pendant
 Ø 56 cm, ↑ 150 cm
 excl. 4 x E14, max. 40 W



102000403
 102000405



MINSK

Metall, Acryl · metal, acryl ·
metale, acryl · metaal, acryl · metal, acrílico ·
metallo, acrílico · metal, acrílic · metalli, akryyli · metal, akryl

Empfohlen:
recommended: Filament LED E14, 4 W
470 lm, 2.700 K



989-400

Pendelleuchte · Pendant
Ø 50 cm, ↑ max. 150 cm
excl. 7 x E14, max. 28 W



308600706



CALAIS

Holz Schwarz, Rauchglas · wood black, smoked glass ·
 bois noir, verre fumé · hout zwart, rookglas · madera negro, vidrio ahumado ·
 di legno nero, vetro fume' · lemn negru, sticla fumurie · puu musta, savulasi ·
 drewno czarny, szkło przydymione

Empfohlen:
 recommended: Filament LED E27, 4 W
 470 lm, 2.700 K



987-400



Pendelleuchte · Pendant
 ↓ 130 cm, Ø 20 cm
 excl. 1 x E27, max. 60 W



304800142



BOOLAN

Holz · wood ·
bois · hout · madera · di legno ·
lemn · puu · drewno

Pendelleuchte · Pendant
Ø 50 cm, †150 cm
excl. 1 x E27, max. 60 W



305900126
305900130

Empfohlen:
recommended: Filament LED E27, 7 W
806 lm, 3.000 K



988-600



26 | Braun · brown



30 | holzfarbig hell · light colored wood

HOLLY

Metall, Weiß matt · metal, white mat ·
metale, blanc mat · metaal, wit mat · metal, estera blanca ·
metallo, bianco opaco · metal, alb mat · metalli, mattavalkoinen ·
metal, biały mat



Pendelleuchte · Pendant
Ø 48 cm, ↑ 150 cm
excl. 3 x E27, max. 42 W



307400331

Empfohlen:
recommended: LED E27, 4,9 W
470 lm, 3.000 K



987-60



ROMINO II

Schwarz matt, Metall · black mat, metal ·
noir mat, metals · mat zwart, metaal ·
estera negra, metal · nero opaco, metallo ·
negru mat, metal · musta matto, metalli ·
czarny mat, metal



Pendelleuchte · Pendant
Ø 50 cm, ↑ 150 cm
excl. 1 x E27, max. 60 W



308000132





LORELEY

Chrom, Acryl, Stoffschirm · chrome, acryl, fabric shade ·
 chrome, acryl, abat-jour tissu · chroom, acryl, Stoffen kap ·
 cromo, acrílico, Pantalla de tela · cromo, acrílico, paralume in tessuto ·
 crom, acrílic, abajur textil · kromi, akryyli, kangas varjostin ·
 chrom, akryl, Klosz z materiału

Empfohlen:
 recommended: Filament LED E14, 4 W
 470 lm, 2.700 K



989-400



Pendelleuchte · Pendant
 Ø 50 cm, ↓ 150 cm
 excl. 3 x E14, max. 40 W



309300302

LEVISTO

Nickel matt oder Messing matt, Glas alabasterfarbig ·
nickel mat or brass mat, alabaster-coloured glass ·
nickel mat ou laiton mat, verre couleur albâtre · nikkell mat of
messing mat, albastkleurig glas · níquel mate o bronze mate, vidrio
de color alabastro · nichel opaco o ottone satinato, vetro colore
alabastro · nichel mat sau bronz mat, sticla culoare alabastru ·
harjattu teräs tai mattamessinki, lasi alabasteri väri · nikiel mat lub
mosiądz mat, szkło alabaster kolor

incl.
LED E14, 5 W
400 lm, 3.000 K



983-60

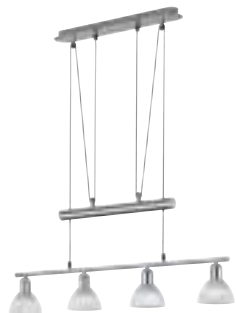

Pendelleuchte · Pendant
↔ 60,5 cm, ↓ 95 - 160 cm
incl. 3 x LED E14, 5 W
3 x 400 lm, 3.000 K



371010307
371010308

Pendelleuchte · Pendant
↔ 80 cm, ↓ 95 - 160 cm
incl. 4 x LED E14, 5 W
4 x 400 lm, 3.000 K



371010407
371010408



FREDDY

Nickel matt, Glas matt · nickel mat, mat glass ·
nickel mat, verre mat · nikkell mat, mat glas ·
níquel mate, vidrio mate · nichel opaco, vetro sabbiato ·
nichel mat, sticla mata · harjattu teräs, mattalasi ·
nikiel mat, szkło matowane

incl.
LED E14, 4 W
320 lm, 3.000 K



983-40

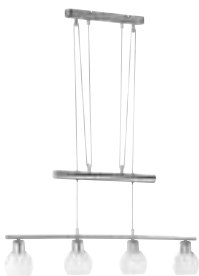

Pendelleuchte · Pendant
↔ 78 cm, ↓ 85 - 180 cm
incl. 4 x LED E14, 4 W
4 x 320 lm, 3.000 K



324810407



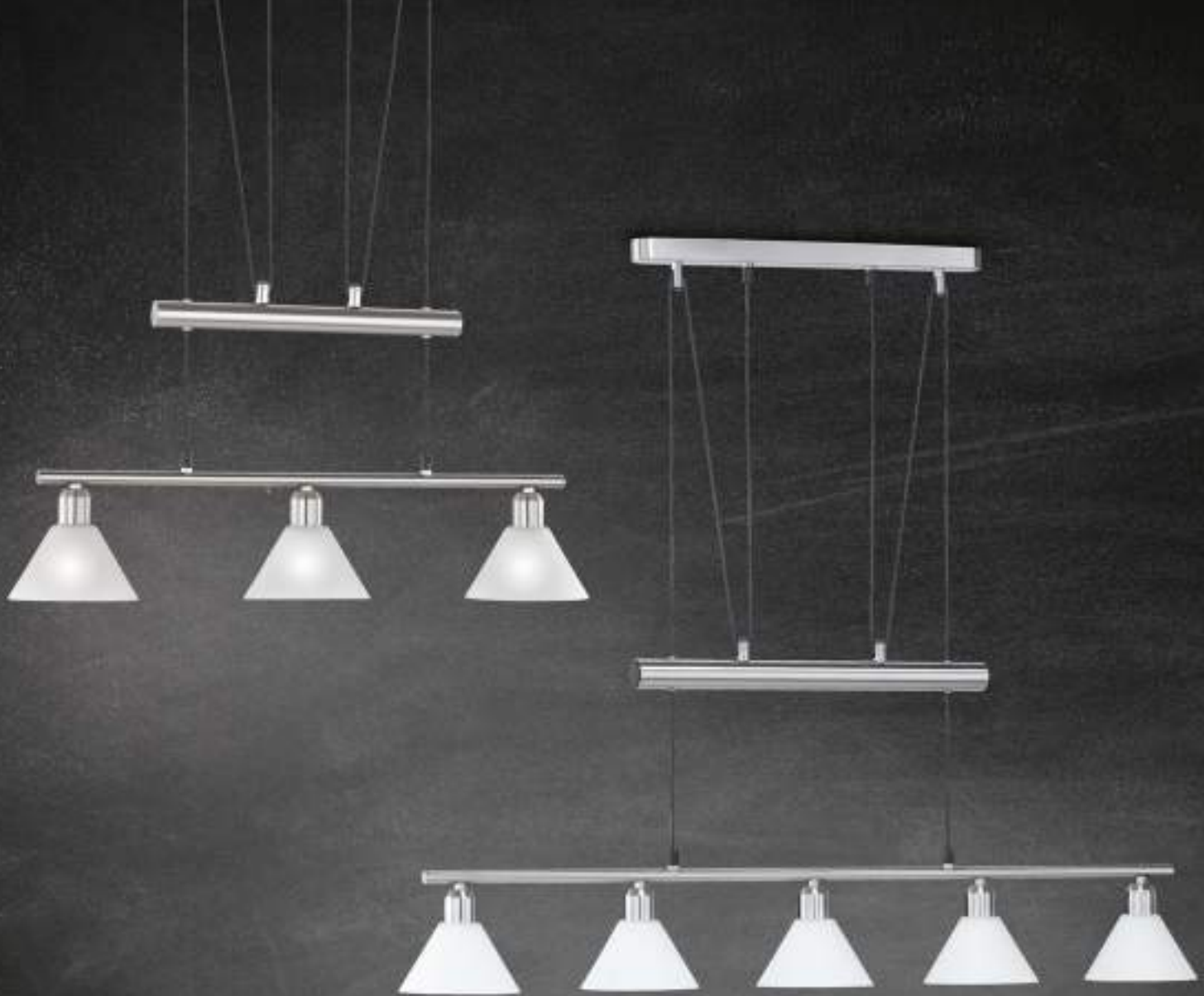

STAMINA

Nickel matt, Glas matt · nickel mat, mat glass ·
 nickel mat, verre mat · nikkel mat, mat glas ·
 níquel mate, vidrio mate · nichel opaco, vetro sabbiato ·
 nichel mat, sticla mata · harjattu teräs, mattalasi ·
 nikiel mat, szkło matowane

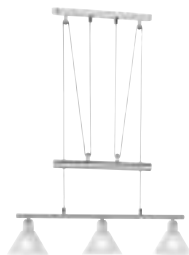

Pendelleuchte · Pendant
 ↔ 66 x 14 cm, ↑ 80 - 180 cm
 excl. 3 x E14, max. 40 W



3751031-07

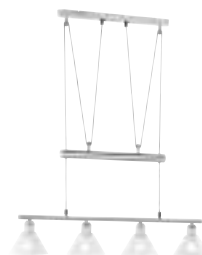

Pendelleuchte · Pendant
 ↔ 80 x 14 cm, ↑ 80 - 180 cm
 excl. 4 x E14, max. 40 W



3751041-07



Pendelleuchte · Pendant
 ↔ 102 x 14 cm, ↑ 80 - 180 cm
 excl. 5 x E14, max. 40 W



3751051-07

COLIN

Nickel matt, Glas matt · nickel mat, mat glass ·
nickel mat, verre mat · nikkell mat, mat glas ·
níquel mate, vidrio mate · nichel opaco, vetro sabbiato ·
nichel mat, sticla mata · harjattu teräs, mattalasi ·
nikiel mat, szkło matowane



242

Pendelleuchte · Pendant

Ø 38,5 cm, ↑ 130 cm
excl. 1 x E27, max. 60 W



3407011-07



DIEGO

Kunststoff, Weiß, Glas · plastic, white, glass ·
Plastique, Blanc, Verre · Kunststof, Wit, Glas ·
Plástico, Blanco, Vidrio · Plastica, Bianco, Vetro ·
Plastic, Alb, Sticla · Muovi, Valkoinen, Lasi ·
Plastik, Biały, Szkło



Pendelleuchte · Pendant

Ø 30 cm, ↑ 125 cm
excl. 1 x E27, max. 60 W



301400101





VIOLA

Glas alabasterfarbig · alabaster-coloured glass ·
 verre couleur albâtre · albastkleurig glas · vidrio de color alabastro ·
 vetro colore alabastro · sticla culoare alabastru · lasi alabasteri väri ·
 szkło alabaster kolor



Pendelleuchte · Pendant

Ø 38,5 cm, ↑ 70 - 130 cm
 excl. 1 x E27, max. 60 W



301700107 | Nickel matt · nickel mat

301700108 | Messing matt · brass mat

BAJO

Metall weiß · metal white ·
metale blanc · metaal wit · metal blanco · metallo bianco ·
metal alb · metalli valkoinen · metal biały

Pendelleuchte · Pendant
Ø 32,5 cm, ↓ 150 cm
excl. 1 x E27, max. 40 W



307290101



244

ZUCCA

Chrom, Acryl · chrome, acryl ·
chrome, acryl · chroom, acryl · cromo, acrílico ·
cromo, acrilico · crom, acrylic · kromi, akryyli · chrom, akryl



00 | Transparent · transparent



06 | Chrom · chrome

Pendelleuchte · Pendant
Ø 40 cm, ↓ 150 cm
excl. 1 x E27, max. 60 W



304100100
304100106





PAPER

Papier, Weiß · paper, white ·
papier, blanc · papier, wit · papel, blanco ·
carta, bianco · hartie, alb · paperi, valkoinen · papier, biały



↑ 73,5 cm
excl. 1 x E27, max. 60 W
VE / moq: 25



3590010-01



Pendelleuchte · Pendant
Ø 40 cm
excl. 1 x E27, max. 60 W
VE / moq: 25



3490400-00



Pendelleuchte · Pendant
Ø 40 cm, ↓ 47 cm
excl. 1 x E27, max. 60 W
VE / moq: 25



3491400-00





Leuchten im Vintage Stil

Vintage style luminaires

Luminaire style Vintage

Armaturen in Vintage stijl

Lámparas vintage

Apparecchi stile vintage

Corpuri de iluminat vintage

Vintage valaisimet

Lampy w stylu vintage



TAILOR

Metall, Nickel antik, Holz · metal, nickel antique, wood ·
 metale, nickel antique, bois · metaal, antiek nikkell, hout · metal, níquel antiguo, madera ·
 metallo, nickel anticato, di legno · metal, nichel antic, lemn · metalli, antiikkiteräs, puu ·
 metal, aikiel antyczny, drewno



Deckenleuchte · Ceiling lamp
 ↔ 115 x 20 cm, ↓ 15,7 cm
 excl. 4 x E27, max. 40 W



614300430



Pendelleuchte · Pendant
 ↔ 115 x 20 cm, ↓ 150 cm
 excl. 4 x E27, max. 40 W



314300430



Tischleuchte · Table lamp
 ↓ 52,5 cm, ↔ 22 x 15 cm
 excl. 2 x E27, max. 40 W



514300230



Stehleuchte · Floor lamp
 ↓ 142,5 cm, ↔ 30 x 22 cm
 excl. 5 x E27, max. 40 W



414300530





BRADLEY

Holz · wood ·
bois · hout · madera · di legno · lemn · puu · drewno



Wandleuchte · Wall lamp
 † 16 x 10,5 cm, † 10,5 cm
 excl. 2 x E27, max. 10 W



203000230

Empfohlen:
recommended: Filament LED E27, 6 W
600 lm, 2.700 K



987-679



BRAD

Nickel antik, Holz · nickel antique, wood ·
nickel antique, bois · antiek nikkel, hout · níquel antiguo, madera ·
nickel anticato, di legno · nichel antic , lemn · antiikkiteräs, puu ·
aikiel antyczny, drewno · antik nikel, tahta

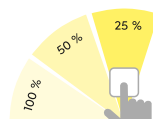

SWITCH DIMMER



Wandleuchte · Wall lamp
 ↓ 11 x 11 cm, ↗ 11 cm
 incl. OSRAM-LED, 4,3 W
 430 lm, 3.000 K



223710130



Wandleuchte · Wall lamp
 ↓ 11 x 37 cm, ↗ 11 cm
 incl. SMD-LED, 13,5 W
 1.500 lm, 3.000 K



223790130



Deckenleuchte · Ceiling lamp
 ↔ 100 x 20 cm, ↑ 16,7 cm
 incl. SMD-LED, 27 W
 3.400 lm, 3.000 K



623710130



Pendelleuchte · Pendant
 ↔ 100 x 20 cm, ↑ 150 cm
 incl. SMD-LED, 27 W
 3.400 lm, 3.000 K



323710130

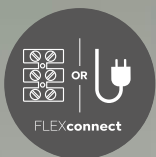

Seite/page 632

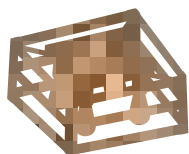
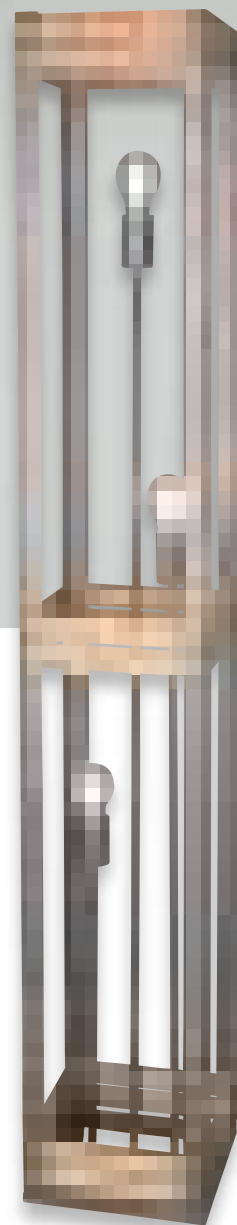
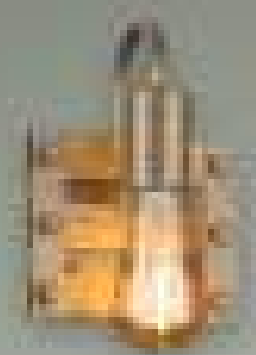

Deckenleuchte · Ceiling lamp
↔ 40 x 40 cm, ↓ 20 cm
excl. 4 x E27, max. 28 W



605500467



Wandleuchte · Wall lamp
↓ 20 cm, ↔ 15 cm, ↗ 11 cm
excl. 1 x E27, max. 28 W



205570167



Wandleuchte · Wall lamp
↓ 20 cm, ↔ 35 cm, ↗ 11 cm
excl. 2 x E27, max. 28 W



205570267



KHAN

Nickel antik, Holz · nickel antique, wood ·
 nickel antique, bois · antiek nikkel, hout · níquel antiguo, madera ·
 nickel anticato, di legno · nichel antic , lemn · antiikkiteräs, puu ·
 aikiel antyczny, drewno · antik nikel, tahta

Empfohlen:
 recommended: Filament LED E27, 6 W
 600 lm, 2.700 K



987-679



Stehleuchte · Floor lamp
 ↓ 153 cm, ↔ 25 x 25 cm
 excl. 3 x E27, max. 10 W



405500367



Pendelleuchte · Pendant
 ↔ 100 x 15 cm, ↓ 150 cm
 excl. 4 x E27, max. 28 W



305500467



Pendelleuchte · Pendant
 ↔ 107,5 cm, ↓ max. 215 cm, Ø 25,5 cm
 excl. 3 x E27, max. 42 W



303400367



Stehleuchte · Floor lamp
 ↓ 150 cm, Ø 25,5 cm, ∠ 21,5 cm
 excl. 1 x E27, max. 42 W



403490167





DELHI

Metall, Nickel antik, Holz · metal, nickel antique, wood ·
 metale, nickel antique, bois · metaal, antiek nikkel, hout · metal, níquel antiguo, madera ·
 metallo, nickel anticato, di legno · metal, nichel antic, lemn · metalli, antiikkiteräs, puu ·
 metal, aikiel antyczny, drewno

Empfohlen:
 recommended: Filament LED E27, 4 W
 470 lm, 2.700 K



987-400



Pendelleuchte · Pendant
 Ø 45 cm, ↑ 150 cm
 excl. 1 x E27, max. 60 W



303400167



DELHI

Metall, Nickel antik, Holz · metal, nickel antique, wood ·
 metale, nickel antique, bois · metaal, antiek nikkell, hout · metal, níquel antiguo, madera ·
 metallo, nickel anticato, di legno · metal, nichel antic, lemn · metalli, antiikkiteräs, puu ·
 metal, aikiel antyczny, drewno



Deckenleuchte · Ceiling lamp
 Ø 11,6 cm, ↗ 20,5 cm
 excl. 1 x E14, max. 40 W



803400167



Deckenleuchte · Ceiling lamp
 ↔ 33 x 11,6 cm, ↓ 20,5 cm
 excl. 2 x E14, max. 40 W



803400267



Deckenleuchte · Ceiling lamp
 ↔ 58 x 11,6 cm, ↓ 20,5 cm
 excl. 3 x E14, max. 40 W



803400367



Stehleuchte · Floor lamp
 ↑ 158 cm, ↔ 66 cm, Ø 40 cm
 excl. 1 x E27, max. 60 W



403400167





Wandleuchte · Wall lamp
 ↑ 32 cm, ↔ 15 cm, ↗ 25,6 cm
 excl. 1 x E14, max. 10 W



209500167



Pendelleuchte · Pendant
 Ø 35 cm, ↑ 150 cm
 excl. 1 x E27, max. 28 W



309500167

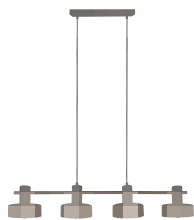

Pendelleuchte · Pendant
 ↔ 90 x 15 cm, ↑ 150 cm
 excl. 4 x E14, max. 28 W



309500467



Stehleuchte · Floor lamp
 ↑ 152 cm, ↗ 77 cm, Ø 35/25 cm
 excl. 1 x E27, max. 10 W



409500167



GAYA

Metall, Nickel antik, Holz · metal, nickel antique, wood ·
 metale, nickel antique, bois · metaal, antiek nikkell, hout · metal, níquel antiguo, madera ·
 metallo, nickel anticato, di legno · metal, nichel antic, lemn · metalli, antiikkiteräs, puu ·
 metal, aikiel antyczyn, drewno · metal, antik nikel, tahta

Empfohlen:
 recommended: Filament LED E27, 4 W
 470 lm, 2.700 K



987-400



Filament LED E14, 4 W
 470 lm, 3.000 K

983-400

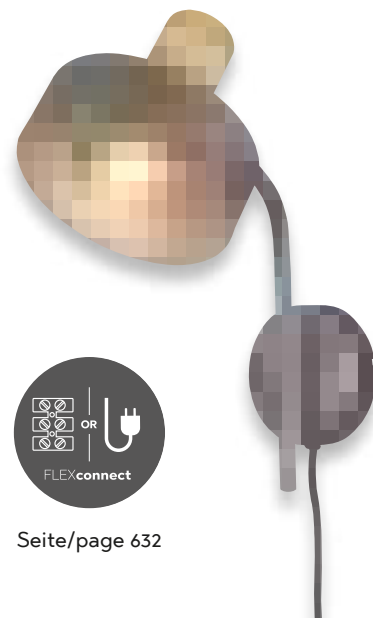

Seite/page 632

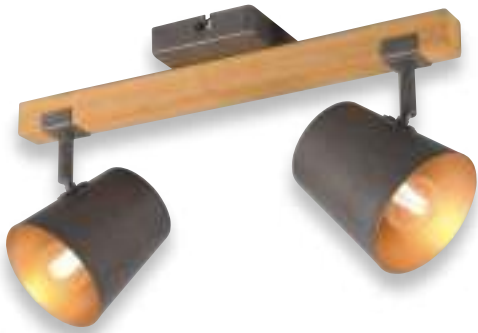

Deckenleuchte · Ceiling lamp
 ↔ 42,5 x 14,5 cm, ↓ 23,2 cm
 excl. 2 x E14, max. 25 W



801900267



Deckenleuchte · Ceiling lamp
 ↔ 58 x 10 cm, ↓ 23 cm
 excl. 3 x E14, max. 25 W



801900367



Wandleuchte · Wall lamp
 ↔ 11 x 11 cm, ↓ 23,2 cm
 excl. 1 x E14, max. 25 W



801900167



Deckenleuchte · Ceiling lamp
 ↔ 39 x 39 cm, ↓ 19,8 cm
 excl. 4 x E14, max. 25 W



601900467



Stehleuchte · Floor lamp
 ↓ 150 cm, ↔ 25 x 25 cm
 excl. 3 x E14, max. 25 W



401900367





BELL

Metall, Nickel antik, innen goldfarbig, Holz · metal, nickel antique, gold colored inside, wood ·
 metale, nickel antique, Or, bois · metaal, antiek nikkel, Binnenkant goudkleur, hout ·
 metal, níquel antiguo, Interior en color dorado, madera · metallo, nickel anticato,
 interno colore oro, di legno · metal, nichel antic, interior culoare aurie, lemn ·
 metalli, antiikkiteräs, sisäosa kullanvärinen, puu · metal, aikiel antyczny, wewnątrz złoty, drewno

Empfohlen:
 recommended: Filament LED E14, 4 W
 470 lm, 3.000 K



983-400



Pendelleuchte · Pendant
 ↔ 100 x 21 cm, ↓ 150 cm
 excl. 4 x E14, max. 25 W



301900467



HARRIS

Metall, Schwarz matt, innen goldfarbig, Holz · metal, black mat, gold colored inside, wood ·
 metale, noir mat, Or, bois · metaal, mat zwart, Binnenkant goudkleur, hout ·
 metal, estera negra, Interior en color dorado, madera · metallo, nero opaco, interno colore oro, di legno ·
 metal, negru mat, interior culoare aurie, lemn · metalli, mattamusta, sisäosa kullanvärinen, puu ·
 metal, czarny mat, wewnątrz złoty, drewno



Pendelleuchte · Pendant
 ↓ 150 cm, Ø 26 cm
 excl. 1 x E27, max. 60 W



312700132



Pendelleuchte · Pendant
 ↓ 150 cm, ↔ 87 cm, Ø 18 cm
 excl. 4 x E27, max. 40 W



312700432



Stehleuchte · Floor lamp
 ↓ 156 cm, ↗ 75 cm, Ø 26 cm
 excl. 1 x E27, max. 60 W



412700132





RODRIGO

Metall, Nickel antik, innen goldfarbig, Holz · metal, nickel antique, gold colored inside, wood ·
 metale, nickel antique, Or, bois · metaal, antiek nikkel, Binnenkant goudkleur, hout ·
 metal, níquel antiguo, Interior en color dorado, madera · metallo, nickel anticato, interno colore oro, di legno ·
 metal, nichel antic, interior culoare aurie, lemn · metalli, antiikkiteräs, sisäosa kullanvärinen, puu ·
 metal, aikiel antyczny, wewnątrz złoty, drewno



Stehleuchte · Floor lamp
 ↓ 165 cm, ↔ 26 cm, ↗ 41 cm
 excl. 1 x E27, max. 60 W



402690167



HENLEY

Metall, Schwarz matt, Holz · metal, black mat, wood ·
 metale, noir mat, bois · metaal, mat zwart, hout · metal, estera negra, madera ·
 metallo, nero opaco, di legno · metal, negru mat, lemn · metalli, mattamusta, puu ·
 metal, czarny mat, drewno



Pendelleuchte · Pendant
 Ø 40 cm, ↓ 150 cm
 excl. 3 x E14, max. 40 W



310730332



Pendelleuchte · Pendant
 ↔ 115 x 18 cm, ↓ 150 cm
 excl. 4 x E14, max. 40 W



310700432



IVAR

Metall, Nickel antik, Holz · metal, nickel antique, wood ·
 metale, nickel antique, bois · metaal, antiek nikkel, hout ·
 metal, níquel antiguo, madera · metallo, nickel anticato, di legno · metal, nichel antic, lemn ·
 metalli, antiikkiteräs, puu · metal, aikiel antyczny, drewno

Empfohlen:
 recommended: Filament LED E27, 6 W
 660 lm, 2.700 K



988-679



Pendelleuchte · Pendant
 Ø 25 cm, ↑ 150 cm
 excl. 1 x E27, max. 40 W



309000167



Pendelleuchte · Pendant
 Ø 40 cm, ↑ 150 cm
 excl. 1 x E27, max. 40 W



309090167



Stehleuchte · Floor lamp
 ↑ 150 - 186 cm, Ø 69 cm
 excl. 1 x E27, max. 40 W



409000167





Empfohlen:
recommended: Filament LED E27, 8 W
806 lm, 2.700 K



987-6810

MADRAS

silberfarbig antik, Holz · antique silver, wood ·
argent antique, bois · antiek zilver, hout · plateado antiguo, madera · argento anticato, di legno ·
argint antic, lemn · antiikkihopea, puu · antyczne srebro, drewno · gümüş antika, tahta



Wandleuchte · Wall lamp
↓ 23 x 14 cm, ↗ 14 x 17 cm
excl. 1 x E27, max. 28 W



805300188



Deckenleuchte · Ceiling lamp
↔ 30 x 14 cm, ↓ 28 cm
excl. 2 x E27, max. 28 W



805300288



Deckenleuchte · Ceiling lamp
↔ 60,5 x 14 cm, ↓ 28 cm
excl. 3 x E27, max. 28 W



805300388



Deckenleuchte · Ceiling lamp
↔ 80 x 14 cm, ↓ 28 cm
excl. 4 x E27, max. 28 W



805300488



Pendelleuchte · Pendant
↔ 90 x 14 cm, ↓ 150 cm
excl. 4 x E27, max. 28 W



305300488





FORESTER

Metall, Nickel antik, Holz · metal, nickel antique, wood ·
 metale, nickel antique, bois · metaal, antiek nikkell, hout · metal, níquel antiguo, madera ·
 metallo, nickel anticato, di legno · metal, nichel antic, lemn · metalli, antiikkiteräs, puu ·
 metal, aikiel antyczny, drewno

Empfohlen:
 recommended: Filament LED E27, 4 W
 470 lm, 2.700 K



987-400



Pendelleuchte · Pendant
 ↔ 100 x 10 cm, ↓ 200 cm
 excl. 5 x E27, max. 42 W



308100567



PLANT

Nickel antik, Sisal · nickel antique, Sisal ·
 nickel antique, Sisal · antiek nikkel, Sisal ·
 níquel antiguo, Sisal · nickel anticato, Sisal ·
 nichel antic, Sisal · antiikkiteräs, Sisal ·
 aikiel antyczny, Sisal

Deko-Pflanze nicht enthalten! · Decoration not included! ·
 Décoration non incluse! · Decoratie niet inbegrepen! ·
 Decoración no incluida. · Decorazione non inclusa! ·
 Decorația nu este inclusă! · Koristus ei sisälly! ·
 Nie zawiera dekoracji!

Empfohlen:
 recommended: Filament LED E27, 4 W
 470 lm, 2.700 K



987-400



92945



Pendelleuchte · Pendant
 ↔ 115 x 22 cm, ↑ 150 cm
 excl. 3 x E27, max. 40 W



301000367



AGRA

Metall, Schwarz matt, Holz · metal, black mat, wood ·
 metale, noir mat, bois · metaal, mat zwart, hout · metal, estera negra, madera ·
 metallo, nero opaco, di legno · metal, negru mat, lemn · metalli, mattamusta, puu ·
 metal, czarny mat, drewno

Empfohlen:
 recommended: Filament LED E27, 4 W
 470 lm, 2.700 K



987-400

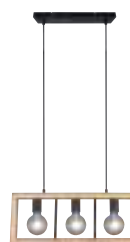

Pendelleuchte · Pendant
 ↔ 60 x 8,5 cm, ↓ 150 cm
 excl. 3 x E27, max. 10 W



313800332



Pendelleuchte · Pendant
 ↔ 100 x 8,5 cm, ↓ 150 cm
 excl. 5 x E27, max. 10 W



313800532



Empfohlen:
recommended: Filament LED E27, 6 W
600 lm, 2.700 K



987-679

TENALI

Metall, Schwarz matt, Holz · metal, black mat, wood ·
metale, noir mat, bois · metaal, mat zwart, hout · metal, estera negra, madera ·
metallo, nero opaco, di legno · metal, negru mat, lemn · metalli, mattamusta, puu ·
metal, czarny mat, drewno

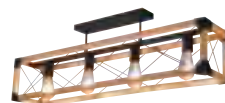

Deckenleuchte · Ceiling lamp
↔ 100 x 20 cm, ↓ 32,6 cm
excl. 4 x E27, max. 40 W



616500432



Pendelleuchte · Pendant
↓ 150 cm, ↔ 100 x 20 cm
excl. 4 x E27, max. 40 W



316500432



Wandleuchte · Wall lamp
 ↔ 9 x 13,7 cm, ↕ 19,5 cm
 excl. 1 x E14, max. 15 W



804370132



Deckenleuchte · Ceiling lamp
 ↔ 26 x 9 cm, ↓ 19,5 cm
 excl. 2 x E14, max. 15 W



804370232



Deckenleuchte · Ceiling lamp
 ↔ 44 x 9 cm, ↓ 19,5 cm
 excl. 3 x E14, max. 40 W



804300332



Deckenleuchte · Ceiling lamp
 ↔ 22 x 22 cm, ↓ 19,5 cm
 excl. 4 x E14, max. 40 W



804300432



Pendelleuchte · Pendant
 ↔ 65 x 9 cm, ↓ 150 cm
 excl. 4 x E27, max. 40 W



304300432



TOSH

Metall, Schwarz matt, Holz · metal, black mat, wood ·
 metale, noir mat, bois · metaal, mat zwart, hout · metal, estera negra, madera ·
 metallo, nero opaco, di legno · metal, negru mat, lemn · metalli, mattamusta, puu ·
 metal, czarny mat, drewno

Empfohlen:
 recommended: Filament LED E14,
 4 W,
 470 lm, 3.000 K



983-400



Pendelleuchte · Pendant
 Ø 10 cm, ↑ 150 cm
 excl. 1 x E27, max. 40 W



304300132



Pendelleuchte · Pendant
 Ø 28 cm, ↑ 150 cm
 excl. 3 x E27, max. 40 W



304330332



Stehleuchte · Floor lamp
 ↑ 150 cm, Ø 23 cm
 excl. 3 x E14, max. 15 W



404300332



Tischleuchte · Table lamp
 ↑ 40 cm, ↔ 15 x 18 cm
 excl. 1 x E14, max. 15 W



504300132



Deckenleuchte · Ceiling lamp
Ø 40 cm, ↓ 37 cm
excl. 1 x E27, max. 60 W



601200101



Pendelleuchte · Pendant
↓ 150 cm, Ø 40 cm
excl. 1 x E27, max. 60 W



301200101



Tischleuchte · Table lamp
↓ 34 cm, Ø 20 cm
excl. 1 x E27, max. 60 W



501200101





KORBA

Holz, Stoffschirm · wood, fabric shade ·
 bois, abat-jour tissu · hout, Stoffen kap ·
 madera, Pantalla de tela · di legno, paralume in tessuto ·
 lemn, abajur textil · puu, kangas varjostin ·
 drewno, Klosz z materiału · tahta, Kumaş şapka



Pendelleuchte · Pendant
 ↓ 150 x 40 cm, ↔ 105 cm
 excl. 2 x E27, max. 60 W



301200201



Stehleuchte · Floor lamp
 ↓ 162 cm, Ø 40 cm
 excl. 1 x E27, max. 60 W



401200101



ELMAU

Holz, Stoffschirm · wood, fabric shade ·
 bois, abat-jour tissu · hout, Stoffen kap · mader, Pantalla de tela ·
 di legno, paralume in tessuto · lemn, abajur textil · puu, kangas varjostin · drewno, Klosz z materiału



Deckenleuchte · Ceiling lamp
 Ø 35 cm, ↑ 36,5 cm
 excl. 1 x E27, max. 60 W



602100130



Pendelleuchte · Pendant
 Ø 35 cm, ↑ 150 cm
 excl. 1 x E27, max. 60 W



302100130



Pendelleuchte · Pendant
 ↔ 100 x 20 cm, ↑ 150 cm
 excl. 4 x E27, max. 60 W



302100430



Tischleuchte · Table lamp
 ↑ 40 cm, Ø 18 cm
 excl. 1 x E14, max. 40 W



502100130







INGA

Rattangeflecht, Metall, Schwarz matt · rattan meshwork, metal, black mat ·
 maillage rotin, métal, noir mat · rotan vlechtwerk, metaal, mat zwart · malla de Rattan, metal, estera negra ·
 reticolo rattan, metallo, nero opaco · impletitura ratan, metal, negru mat · rottinki, metalli, mattamusta · rattan, metal, czarny mat



Deckenleuchte · Ceiling lamp
 Ø 50 cm, ↓ 30 cm
 excl. 3 x E27, max. 40 W



612200336



Pendelleuchte · Pendant
 Ø 29 cm, ↓ 150 cm
 excl. 1 x E27, max. 40 W



312200136



Pendelleuchte · Pendant
 Ø 50 cm, ↓ 150 cm
 excl. 3 x E27, max. 40 W



312200336



Tischleuchte · Table lamp
 ↓ 30 cm, Ø 16,5 cm
 excl. 1 x E27, max. 40 W



512200136

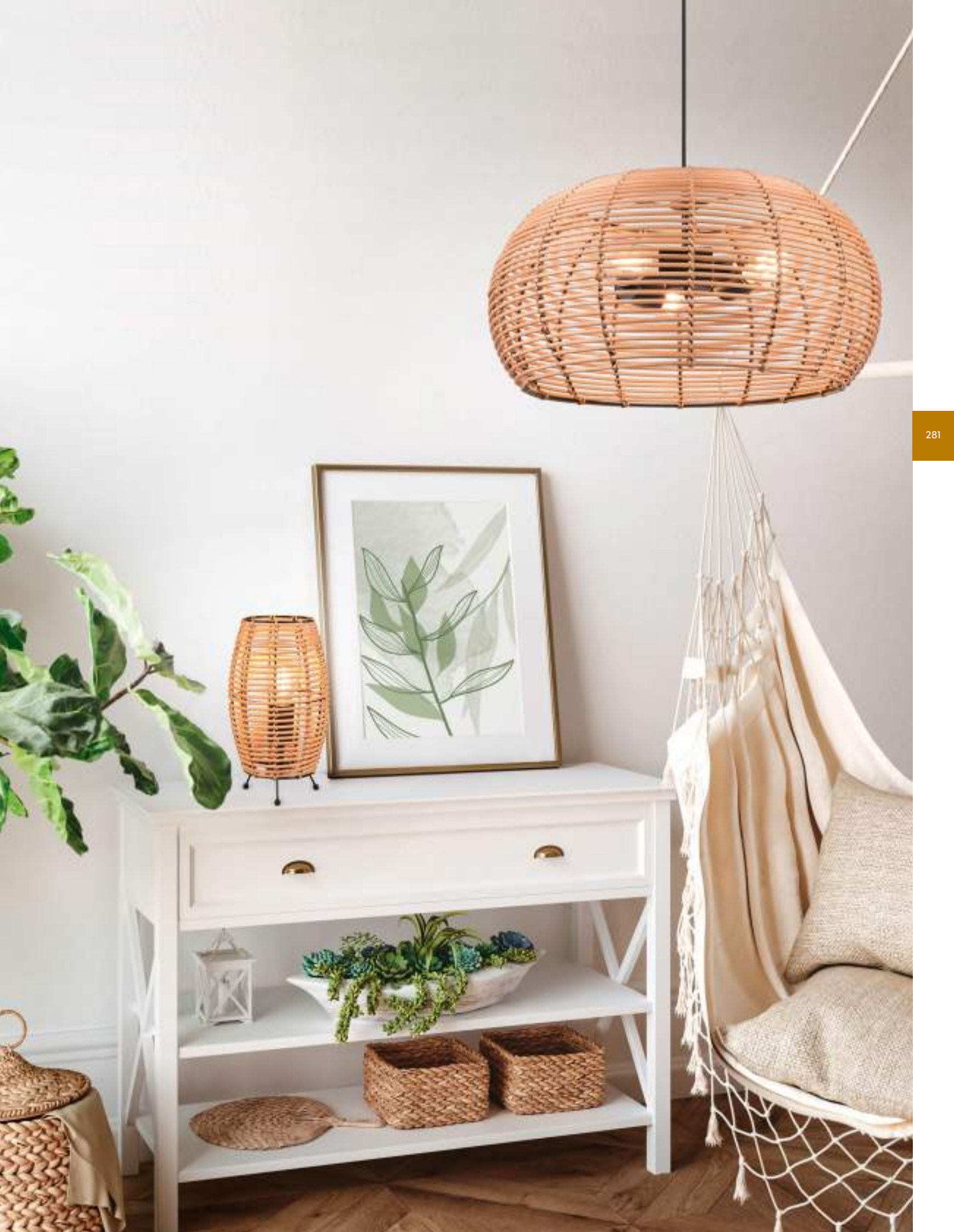



COLINO

Metall, Holz · metal, wood ·
metale, bois · metaal, hout · metal, madera · metallo, di legno ·
metal, lemn · metalli, puu · metal, drewno · metal, tahta

Empfohlen:
recommended: Filament LED E27, 4 W
470 lm, 2.700 K



987-400



32 | Schwarz matt · black mat



42 | naturbelassen · natural finish



Deckenleuchte · Ceiling lamp
Ø 40 cm, ↑ 26 cm
excl. 2 x E27, max. 40 W



615900232
615900242

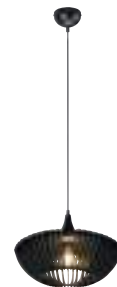

Pendelleuchte · Pendant
Ø 40 cm, ↑ 150 cm,
excl. 1 x E27, max. 40 W



315900132
315900142





HEDDA

Metall, Schwarz matt, Sisal · metal, black mat, Sisal ·
 metale, noir mat, Sisal · metaal, mat zwart, Sisal · metal, estera negra, Sisal ·
 metallo, nero opaco, Sisal · metal, negru mat, Sisal · metalli, mattamusta, Sisal ·
 metal, czarny mat, Sizat

Empfohlen:
 recommended: Filament LED E27, 4 W
 470 lm, 2.700 K



987-400



Deckenleuchte · Ceiling lamp
 Ø 52 cm, ↓ 28 cm
 excl. 2 x E27, max. 40 W



612300236



Pendelleuchte · Pendant
 Ø 52 cm, ↓ 150 cm
 excl. 1 x E27, max. 40 W



312300136



RUNA

Metall, Schwarz matt, Sisal · metal, black mat, Sisal ·
 metale, noir mat, Sisal · metaal, mat zwart, Sisal · metal, estera negra, Sisal · metallo, nero opaco, Sisal ·
 metal, negru mat, Sisal · metalli, mattamusta, Sisal · metal, czarny mat, SIZal



Deckenleuchte · Ceiling lamp
 ↑ 27,5 cm, ↔ 23 cm, ↗ 15 cm
 excl. 1 x E27, max. 40 W



203000132



Pendelleuchte · Pendant
 Ø 25 cm, ↓ 150 cm
 excl. 1 x E27, max. 40 W



303000132



Pendelleuchte · Pendant
 Ø 35 cm, ↓ 150 cm
 excl. 1 x E27, max. 40 W



303090132



Stehleuchte · Floor lamp
 ↓ 150 cm, Ø 35 cm
 excl. 1 x E27, max. 40 W



403000132

JUDITH

Glas klar · clear glass ·
verre claire · helder glas ·
vidrio claro · vetro chiaro ·
sticlă transparentă · kirkas lasi ·
przezroczyste szkło



Pendelleuchte · Pendant

Ø 24,5 cm, † 150 cm
excl. 1 x E27, max. 60 W



302900102

Empfohlen:

recommended: Filament LED E27, 6 W
420 lm, 2.700 K



987-679



ROTIN

Rattangeflecht, Grau antik · rattan meshwork, antique grey ·
maillage rotin, gris ancien · rotan vlechtwerk, antiek grijs ·
malla de rattan, gris antiguo · reticolo rattan, grigio antico ·
impletitura ratan, antic gri · rottinki, antiikki harmaa ·
rattan, starodawny szary



Pendelleuchte · Pendant

Ø 39 cm, † 150 cm
excl. 1 x E27, max. 42 W



310900111

Empfohlen:

recommended: Filament LED E27, 7 W
806 lm, 3.000 K



988-600





ROPE

Metall, Altmessing · metal, old brass ·
 metale, laiton fumé · metaal, oud brons · metal, bronze viejo ·
 metallo, ottone invecchiato · metal, bronz antic ·
 metalli, antiikkimessinki · metal, patyna

Empfohlen:

recommended: Filament LED E27, 7 W
 806 lm, 3.000 K



988-600

Filament LED E27, 6 W
 660 lm, 2.700 K



988-679



Pendelleuchte · Pendant
 Ø 12 cm, ↓ 150 cm
 excl. 1 x E27, max. 60 W



310100104



Pendelleuchte · Pendant
 Ø 12 cm, ↓ 150 cm
 excl. 2 x E27, max. 60 W



310100204



GOTHAM

Metall, Silber antik · metal, antique silver ·
 metale, argente antique · metaal, antiek zilver · metal, plateado antiguo ·
 metallo, argento anticato · metal, argint antic · metalli, antiikkihopea ·
 metal, antyczne srebro

Empfohlen:
 recommended: Filament LED E27, 6 W
 600 lm, 2.700 K



987-679



Wandleuchte · Wall lamp
 ↓ 46,5 x 14,6 cm, ↗ 17,3 cm
 excl. 1x E27, max. 60 W



207000188



Pendelleuchte · Pendant
 ↓ 150 cm, Ø 14,6 cm
 excl. 1x E27, max. 60 W



307000188



Pendelleuchte · Pendant
 ↔ 102 x 46 cm, ↓ 150 cm
 excl. 6 x E27, max. 60 W



307000688





TANJA

Metall, Schwarz · metal, black ·
metale, noir · metaal, zwart · metal, negro ·
metallo, nero · metal, negru · metalli, musta · metal, czarny



Pendelleuchte · Pendant
Ø 39 cm, ↑ 150 cm
excl. 1 x E27, max. 60 W



300700102

Empfohlen:
recommended: Filament LED E27, 7 W
806 lm, 3.000 K



988-600

SANNA

Metall · metal ·
metale · metaal · metal · metallo · metal · metalli · metal



Pendelleuchte · Pendant
Ø 25 cm, ↑ 150 cm
excl. 1 x E27, max. 60 W



300900101
300900102



01 | Weiß · white



02 | Schwarz · black



Empfohlen:
recommended: Filament-LED E27, 4 W
470 lm, 2.700 K



987-400

JOHANN

Metall, Grau antik oder Kupfer antik · metal, antique grey or antique copper ·
metale, gris ancien ou cuivre ancien · metaal, antiek grijs of antiek koper · metal, gris antiguo o cobre antiguo ·
metallo, grigio antico o rame antico · metal, antic gri sau cupru antic ·
metalli, antiikki harmaa tai antiikki kupari · metal, starodawny szary lub antyczne miedzi



32 | Schwarz matt · black mat



61 | Grau antik · antique grey



62 | Kupfer antik · antique copper



Deckenleuchte · Ceiling lamp
Ø 30 cm, ↓ 18 cm
excl. 1 x E27, max. 60 W



606903032
606903062



Deckenleuchte · Ceiling lamp
Ø 40 cm, ↓ 17 cm
excl. 1 x E27, max. 60 W



606900132
606900161
606900162



Deckenleuchte · Ceiling lamp
Ø 50 cm, ↓ 18 cm
excl. 1 x E27, max. 60 W



606905032
606905062



LARA

Metall, Glas matt · metal, mat glass ·
 metale, verre mat · metaal, mat glas · metal, vidrio mate ·
 metallo, vetro sabbato · metal, sticla mata · metalli, matalasi ·
 metal, szkło matowane

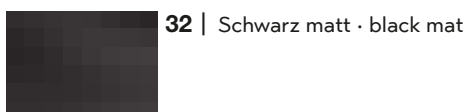

32 | Schwarz matt · black mat



61 | Grau antik · antique grey



62 | Kupfer antik · antique copper

Empfohlen:
 recommended: LED E14, 4 W
 320 lm, 3.000 K



983-40

Tischleuchte · Table lamp
 ↔ 29 x 15 cm, ↓ 21 cm
 excl. 1 x E14, max. 40 W



508400132
508400161
508400162



CORD

Kupfer antik, Stoffkabel · antique copper, fabric sheathed cable ·
 cuivre ancien, câble gainé de tissu · antiek koper, kabel met
 stofmantel · cobre antiguo, cable forrado de tela · rame antico,
 cavo rivestito in tessuto · cupru antic, țesătură din fibră de sticlă ·
 antiikki kupari, kangaspäällysteinen kaapeli · antyczne miedzi,
 kabel z osłoną z tkaniny

Empfohlen:
 recommended: Filament LED E27, 6 W
 660 lm, 2.700 K



988-679



Pendelleuchte · Pendant
 Ø 12 cm, ↓ 150 cm
 excl. 1 x E27, max. 60 W



310100162



Pendelleuchte · Pendant
 ↓ 150 cm, ↔ max. 180 cm
 excl. 5 x E27, max. 60 W



310100562



JASMIN

Metall · metal ·
metale · metaal · metal · metallo ·
metal · metalli · metal

Pendelleuchte · Pendant
Ø 19 cm, ↑ 150 cm
excl. 1 x E14, max. 40 W



303700104
303700161
303700162

Empfohlen:
recommended: Filament LED E14, 4 W
470 lm, 2.700 K



989-400



04 | Altmessing · old brass



61 | Grau antik · gray antique



62 | kupferfarbig antik · copper-coloured antique



FISHERMAN

Metall, Glas klar · metal, clear glass ·
 metale, verre claire · metaal, helder glas · metal, vidrio claro ·
 metallo, vetro chiaro · metal, sticlă transparentă · metalli, kirkas lasi · metal, przezroczyste szkło



04 | Altmessing · old brass



61 | Grau antik · gray antique



62 | kupferfarbig antik · copper-coloured antik

Empfohlen:
 recommended: Filament LED E27, 4 W
 470 lm, 2.700 K



987-400

Pendelleuchte · Pendant
 Ø 32 cm, ↑ 150 cm
 excl. 1 x E27, max. 28 W



304500104
304500161
304500162





Wand- & Deckenleuchten

Wall- & Ceiling lamps

Plafonniers & appliques

Wandlampen & plafonnières

Apliques y plafones

Applique e plafoniere

Plafoniere si aplice

Seinä- & katto

Sufitowe i ścienne

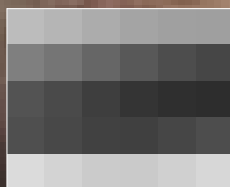

DIP SWITCH

Lichtfarben direkt an der Leuchte einstellbar · Colours directly adjustable at the lamp ·
 Les couleurs de la lumière peuvent être réglées directement sur le luminaire ·
 Lichtkleuren direct instelbaar op de lamp · Tonalidades de luz ajustables directamente en la lámpara ·
 Colori della luce regolabili direttamente sulla lampada · Culori ale luminii reglabile direct de la bec ·
 Valon väri asetettävissa suoraan valaisimesta · Barwy światła można ustawić bezpośrednio na oprawie

CAYA

Aluminium gebürstet oder Messing matt, Schwarz matt · brushed aluminium or brass mat, black mat ·
 Aluminium balayé ou Laiton mat, Noir mat · Geborsteld aluminium of Messing mat, Mat zwart ·
 Aluminio pulido o Bronce mate, Estera negra · Alluminio spazzolato o Ottone satinato, Nero opaco ·
 Aluminiu lucios sau Bronz mat, Negru mat · Harjattu alumiini tai Mattamessinki, mattamusta ·
 Aluminium szczotkowane lub Mosiądz mat, Czarny mat

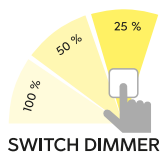

SWITCH DIMMER

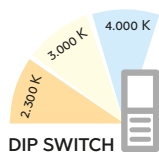

DIP SWITCH



05 | Aluminium gebürstet / Schwarz matt ·
 brushed aluminium / black mat

08 | Messing matt / Schwarz matt ·
 brass mat / black mat

Deckenleuchte · Ceiling lamp
 Ø 50 cm, ↓ 9 cm
 incl. SMD-LED, 58 W
 6.800 lm, 2.300 + 3.000 + 4.000 K



641910205
 641910208



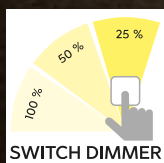

LUGO

Metall, Schwarz matt, goldfarbig · metal, black mat, gold ·
 Métal, Noir mat, Or · Metaal, Mat zwart, Goud · Metal, Estera negra, Oro · Metallo, Nero opaco, Oro ·
 Metal, Negru mat, Aur · Metalli, mattamusta, Kultaa · Metal, Czarny mat, Złota



Wandleuchte · Wall lamp
 ↔ 29 x 29 cm, ↗ 6,5 cm
 incl. SMD-LED, 12 W
 1.450 lm, 3.000 K



242910180



Deckenleuchte · Ceiling lamp
 ↔ 52,5 x 54 cm, ↓ 10 cm
 incl. SMD-LED, 28 W
 3.400 lm, 3.000 K



642910280



Deckenleuchte · Ceiling lamp
 ↔ 74 x 74 cm, ↓ 13 cm
 incl. SMD-LED, 50 W
 6.150 lm, 3.000 K



642910380





Deckenleuchte · Ceiling lamp
↔ 59 x 43 cm, ↑ 8,5 cm
incl. SMD-LED, 29 W
2.650 lm, 3.000 K

Deckenleuchte · Ceiling lamp
↔ 85 x 60 cm, ↑ 8,5 cm
incl. SMD-LED, 36 W
3.250 lm, 3.000 K



673810206
673810232

673890206
673890232

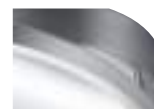

06 | Chrom · chrome



32 | Schwarz matt · black mat



GRANADA

Chrom, Weiß matt oder Schwarz matt, goldfarbig · chrome white mat, or black mat, gold ·
 chrome blanc mat, ou noir mat, or · chrom wit mat, of mat zwart, goud ·
 cromo estera blanca, o estera negra, oro · cromo bianco opaco,
 o nero opaco, oro · crom alb mat, sau negru mat, aur ·
 kromi mattavalkoinen, tai mattamusta, kultaa ·
 chrom biały mat, lub czarny mat, złota

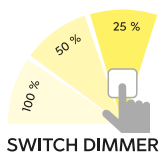

SWITCH DIMMER



Deckenleuchte · Ceiling lamp
 ↔ 71,5 x 63,5 cm, ↓ 10,5 cm
 incl. SMD-LED, 36 W
 4.300 lm, 3.000 K



673810306
 673810332

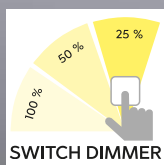

SWITCH DIMMER



Deckenleuchte · Ceiling lamp
 Ø 62,5 cm, ↑ 6 cm
 incl. SMD-LED, 30 W
 3.800 lm, 4.000 K



642110331



Deckenleuchte · Ceiling lamp
 ↔ 95,5 x 40 cm, ↑ 6,5 cm
 incl. SMD-LED, 37 W
 4.800 lm, 4.000 K



642110431



Deckenleuchte · Ceiling lamp
 Ø 62,5 cm, ↑ 6 cm
 incl. SMD-LED, 30 W
 3.600 lm, 3.000 K



642110332



Deckenleuchte · Ceiling lamp
 ↔ 95,5 x 40 cm, ↑ 6,5 cm
 incl. SMD-LED, 37 W
 4.600 lm, 3.000 K



642110432

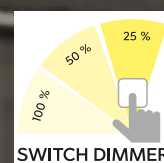

GROOVY

Metall, Kristallglas · metal, crystalglass ·
 métal, cristalverre · metaal, kristalglas · metal, cristalvidrio ·
 metallo, cristallovetro · metal, cristalsticla · metalli, kristallilasi · metal, kryształszkło



31 | Weiß matt · white mat

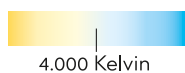

4.000 Kelvin



32 | Schwarz matt · black mat





GALE

Metall, Nickel matt, Weiß matt oder Schwarz matt · metal, nickel mat, white mat or black mat ·
 metale, nickel mat, blanc mat ou noir mat · metaal, nikkell mat, wit mat of mat zwart ·
 metal, níquel mate, estera blanca o estera negra · metallo, nichel opaco, bianco opaco o nero
 opaco · metal, nichel mat, alb mat sau negru mat · metalli, harjattu teräs, mattavalkoinen tai
 mattamusta · metal, nikiel mat, biały mat lub czarny mat

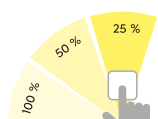

SWITCH DIMMER



07 | Nickel matt ·
nickel mat



31 | Weiß matt ·
white mat



32 | Schwarz matt ·
black mat



Deckenleuchte · Ceiling lamp
 ↔ 60 x 43 cm, ↑ 13,5 cm
 incl. SMD-LED, 38,5 W
 5.000 lm, 3.000 K



673916007
673916031
673916032



Deckenleuchte · Ceiling lamp
 ↔ 80 x 65 cm, ↑ 14,5 cm
 incl. SMD-LED, 50 W
 7.000 lm, 3.000 K



673918007
673918031
673918032



AVUS

Metall, Nickel matt · metal, nickel mat ·
metale, nickel mat · metaal, nikkel mat · metal, níquel mate ·
metallo, nichel opaco · metal, nichel mat · metalli, harjattu teräs ·
metal, nikiel mat

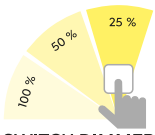

SWITCH DIMMER



308

Deckenleuchte · Ceiling lamp

↔ 90 x 25 cm, ↓ 9 cm
incl. SMD-LED, 35 W
3.700 lm, 3.000 K



629010107



TIRIAC

Metall · metal ·
metale · metaal · metal · metallo · metal · metalli · metal

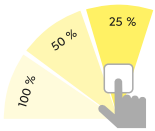

SWITCH DIMMER



07 | Nickel matt · nickel mat



31 | Weiß matt · white mat

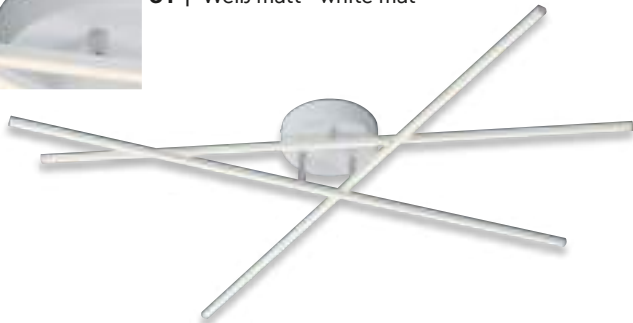

Deckenleuchte · Ceiling lamp

↔ 100 cm, ↓ 12 cm
incl. 3 x SMD, 8,5 W
3 x 950 lm, 3.000 K



671610307

671610331





YAVA

Metall, Acryl · metal, acryl ·
metale, acryl · metaal, acryl · metal, acrílico ·
metallo, acrilico · metal, acrylic · metalli, akryyli · metal, akryl



Lichtfarbe stufenlos einstellbar ·
Light color infinitely variable



Integrierter Dimmer ·
Integrated dimmer

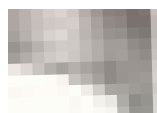

07 | Nickel matt · nickel mat

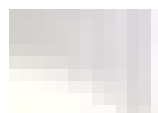

31 | Weiß matt · white mat

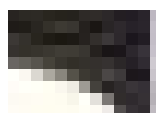

32 | Schwarz matt · black mat

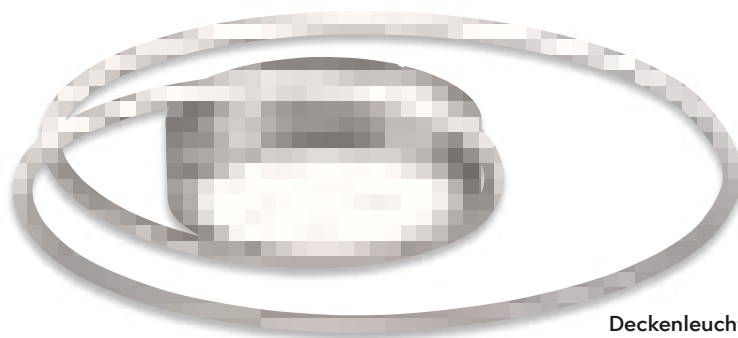

Deckenleuchte · Ceiling lamp
Ø 60 cm, ↓ 7 cm
incl. SMD-LED, 56 W
6.800 lm, 2.700 - 6.000 K



672310207
672310231
672310232



DIP SWITCH

Lichtfarben direkt an der Leuchte einstellbar · Colours directly adjustable at the lamp ·
 Les couleurs de la lumière peuvent être réglées directement sur le luminaire ·
 Lichtkleuren direct instelbaar op de lamp · Tonalidades de luz ajustables directamente en la lámpara ·
 Colori della luce regolabili direttamente sulla lampada · Culori ale luminii reglabile direct de la bec ·
 Valon väri asetettävissa suoraan valaisimesta · Barwy światła można ustawić bezpośrednio na oprawie

SALSA

Metall, Acryl · metal, acryl ·
 metale, acryl · metaal, acryl · metal, acrílico ·
 metallo, acrilico · metal, acrilic · metalli, akryyli · metal, akryl

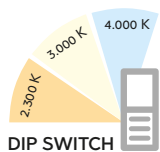

DIP SWITCH

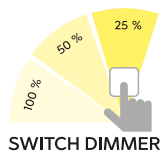

SWITCH DIMMER



31 | Weiß matt · white mat



32 | Schwarz matt · black mat



87 | titanfarbig · titan

Deckenleuchte · Ceiling lamp
 ↔ 115 x 40,5 cm, ↑ 6,6 cm
 incl. SMD-LED, 46 W
 5.350 lm, 2.300 + 3.000 + 4.000 K



626710531
 626710532
 626710587



CHARLESTON

Metall, Aluminium gebürstet oder Anthrazit · metal, brushed aluminium or anthracite ·
 metale, aluminium balayé ou antracite · metaal, geborsteld aluminium of antraciet ·
 metal, aluminio pulido o antracita · metallo, alluminio spazzolato o antracite ·
 metal, aluminiu lucios sau antracit · metalli, harjattu alumiini tai antrasiitti ·
 metal, aluminium szczotkowane lub antracyt



Getrennt schaltbar ·
 Separately switchable



Memory Funktion ·
 Memory function



1x



2x



3x



Deckenleuchte · Ceiling lamp

↔ 101 x 38 cm, ↓ 12,5 cm

incl. SMD-LED, 22 W

2.600 lm, 3.000 K

incl. SMD-LED, 12 W

1.600 lm, 3.000 K



672110505 | Aluminium gebürstet · brushed aluminium

672110542 | Anthrazit · anthracite



SEDONA

Metall, Holznachbildung · metal, wood imitation ·
 metale, imitacion bois · metaal, houtimitatie ·
 metal, imitacion de madera · metallo, effetto legno ·
 metal, imitatie de lemn · metalli, puujäljitelmä ·
 metal, imitacja drewna

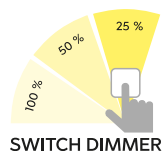

SWITCH DIMMER

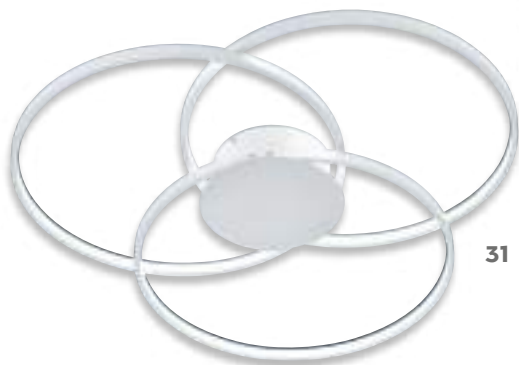

06

Deckenleuchte · Ceiling lamp
 Ø 80 cm, ↑ 8 cm
 incl. SMD-LED, 40 W
 3.600 lm, 3.000 K



673210306 | Chrom · chrome
 673210331 | Weiß matt · white mat
 673210332 | Schwarz matt, Holznachbildung ·
 black matt, wood imitation



TUCSON

Metall, Schwarz matt / Holznachbildung · metal, black mat / wood imitation ·
 Métal, Noir mat / imitation bois · Metaal, Mat zwart / houtimitatie · Metal, Estera negra / imitación de madera ·
 Metallo, Nero opaco / effetto legno · Metal, Negru mat / imitație de lemn · Metalli, mattamusta / puujäljitelmä ·
 Metal, Czarny mat / imitacja drewna

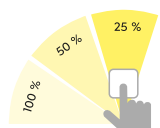

SWITCH DIMMER

Deckenleuchte · Ceiling lamp

↔ 104 x 42 cm, ↑ 8,5 cm
 incl. SMD-LED, 35 W
 4.400 lm, 3.000 K



672610332

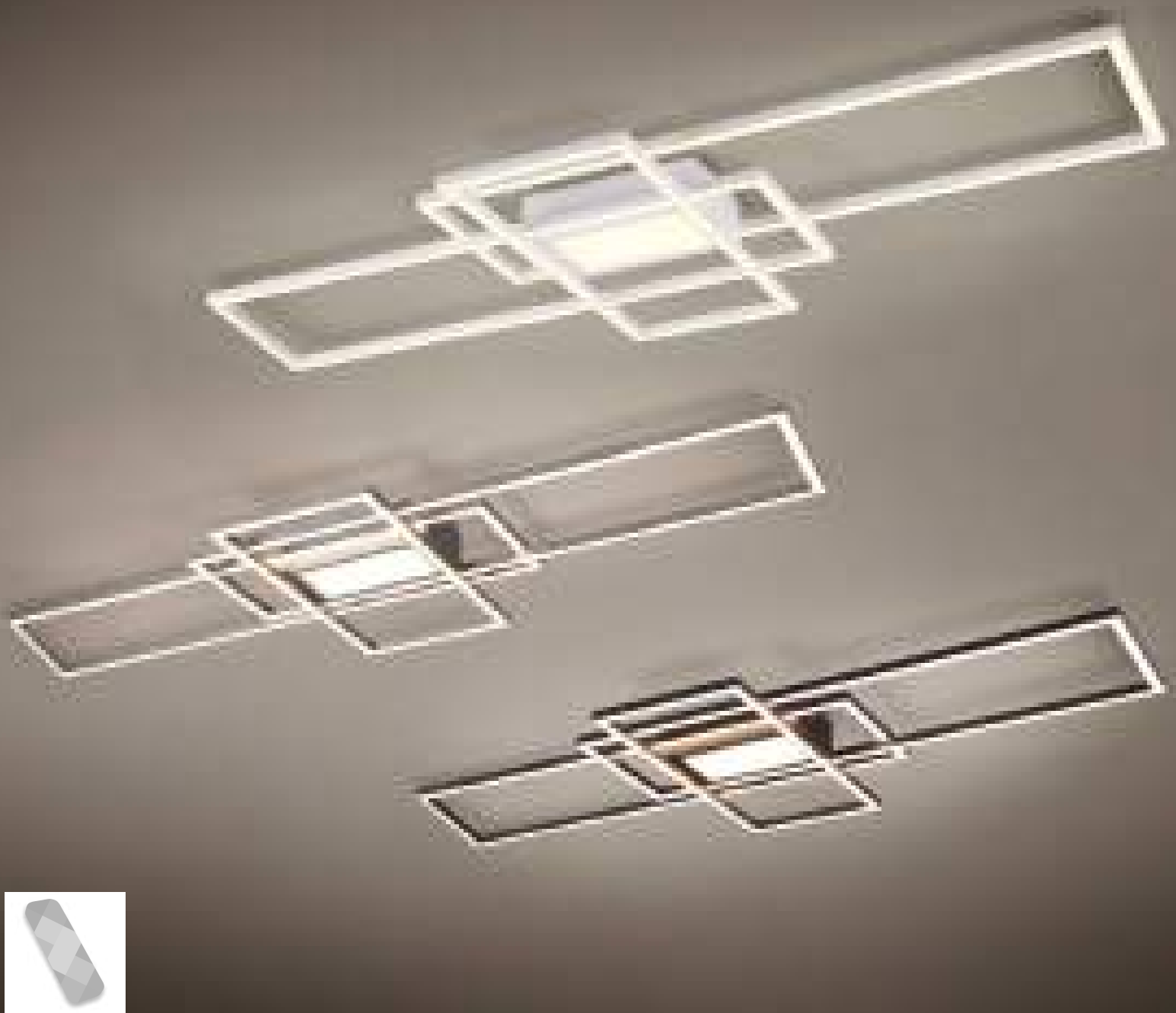

IRVINE

Metall · metal ·
metale · metaal · metal · metallo · metal · metalli · metal



Lichtfarbe stufenlos einstellbar ·
Light color infinitely variable



Integrierter Dimmer ·
Integrated dimmer



Memory Funktion ·
Memory function

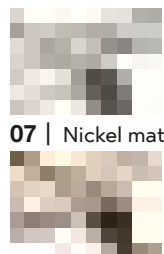

07 | Nickel matt · nickel mat

08 | Messing matt · brass mat

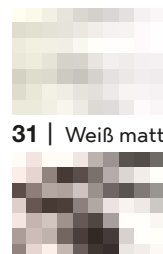

31 | Weiß matt · white mat

42 | Anthrazit · anthracite

Deckenleuchte · Ceiling lamp

↔ 105 x 42 cm, ↓ 6,5 cm
incl. SMD-LED, 60 W
7.100 lm, 3.000 - 6.500 K



620010407
620010408
620010431
620010442





GANADO

Metall, Nickel matt oder Schwarz matt · metal, nickel mat or black mat ·
 metale, nickel mat ou noir mat · metaal, nikkel mat of mat zwart · metal, níquel mate o estera negra ·
 metallo, nichel opaco o nero opaco · metal, nichel mat sau negru mat · metalli, harjattu teräs tai mattamusta ·
 metal, nikiel mat lub czarny mat



RGBW Farbwechsler ·
 RGBW Colorchanging



Lichtfarbe stufenlos einstellbar ·
 Light color infinitely variable



Getrennt schaltbar ·
 Separately switchable



indirekte Beleuchtung ·
 indirect lighting

Deckenleuchte · Ceiling lamp

↔ 110 x 21,2 cm, ↓ 7 cm
 incl. SMD-LED, 37 W
 4.300 lm, 2.700 - 6.500 K
 incl. RGB-LED, 8 W



670710507 | Nickel matt · nickel mat
 670710532 | Schwarz matt · black mat



WINONA

Metall, Nickel matt oder Schwarz matt · metal, nickel mat or black mat ·
 metale, nickel mat ou noir mat · metaal, nikkel mat of mat zwart ·
 metal, níquel mate o estera negra · metallo, nichel opaco o nero opaco ·
 metal, nichel mat sau negru mat · metalli, harjattu teräs tai mattamusta ·
 metal, nikiel mat lub czarny mat



RGBW Farbwechsler ·
 RGBW Colorchanging



Lichtfarbe stufenlos einstellbar ·
 Light color infinitely variable



Getrennt schaltbar ·
 Separately switchable



indirekte Beleuchtung ·
 indirect lighting



Deckenleuchte · Ceiling lamp

↔ 78 x 62 cm, ↑ 11,5 cm
 incl. SMD-LED, 28 W
 3.200 lm, 2.700 - 6.500 K
 incl. RGB-LED, 10 W



670810607 | Nickel matt · nickel mat

670810632 | Schwarz matt · black mat

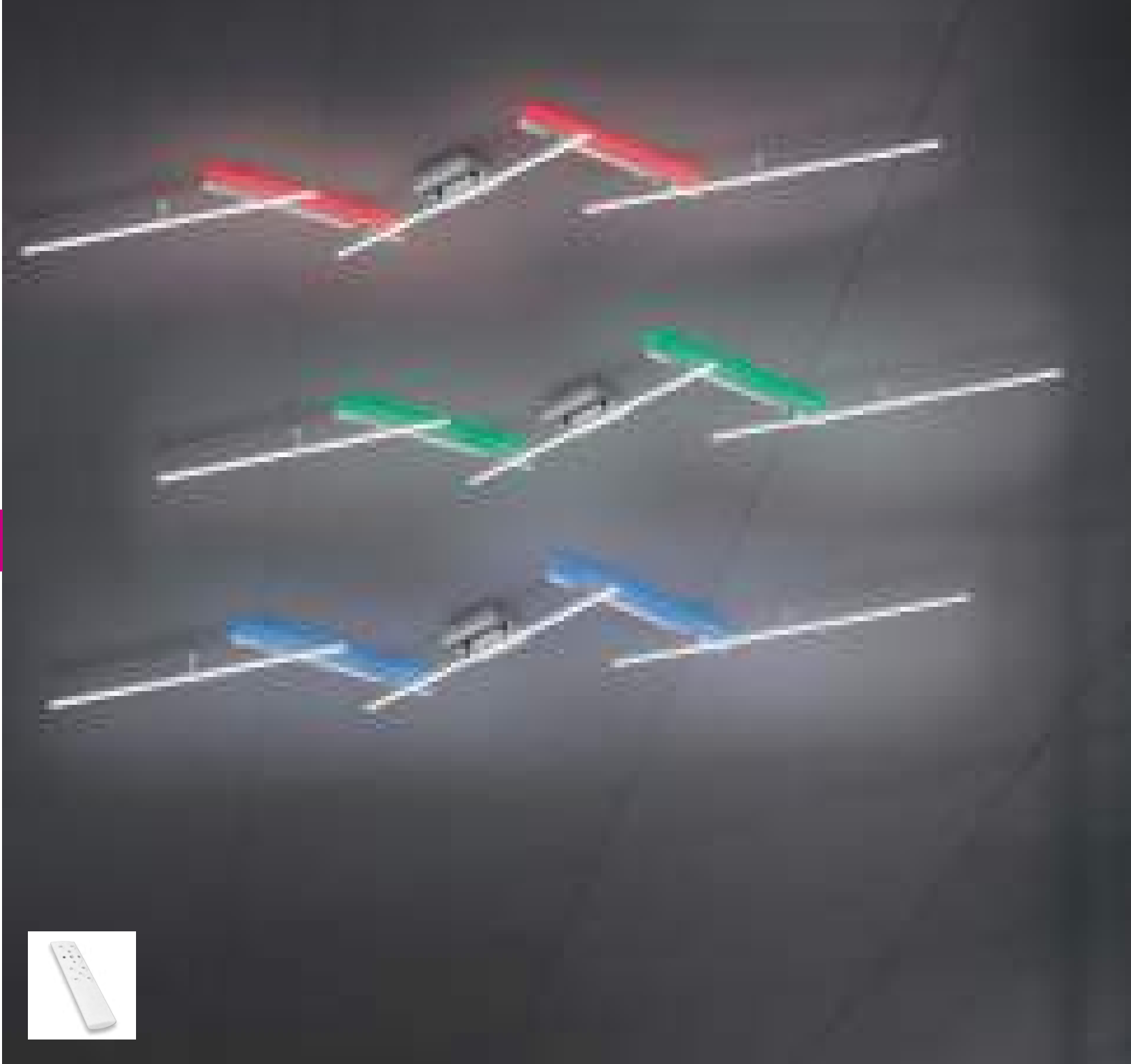

Gibt Licht nach oben und unten, getrennt schaltbar · up and down lighting, separately switchable ·
 point lumineux en haut et en bas, interrupteurs séparés · lichtpunt boven en onder, gescheiden schakelbaar ·
 luz de arriba y abajo, interruptores separados · luce su e giù, interruttori separati · sus și în jos lumina, intreruptoare separate ·
 ylös ja alas valoa, erikseen kytkettävissä · w górę iw dół światło, oddzielny przełącznik







ARVIN

Metall, Nickel matt oder Schwarz matt · metal, nickel mat or black mat ·
 metale, nickel mat ou noir mat · metaal, nikkel mat of mat zwart · metal, níquel mate o estera negra ·
 metallo, nichel opaco o nero opaco · metal, nichel mat sau negru mat · metalli, harjattu teräs tai mattamusta ·
 metal, nikiel mat lub czarny mat

 RGBW Farbwechsler ·
 RGBW Colorchanging

 Lichtfarbe stufenlos einstellbar ·
 Light color infinitely variable

 Getrennt schaltbar ·
 Separately switchable

 **07** | Nickel matt · nickel mat

 **32** | Schwarz matt · black mat

Deckenleuchte · Ceiling lamp

↔ max. 245 x 50 cm, ↑ 8,5 cm

incl. SMD-LED, 22 W

2.600 lm, 2.700 - 6.500 K

incl. RGB-LED, 8 W



628410507

628410532

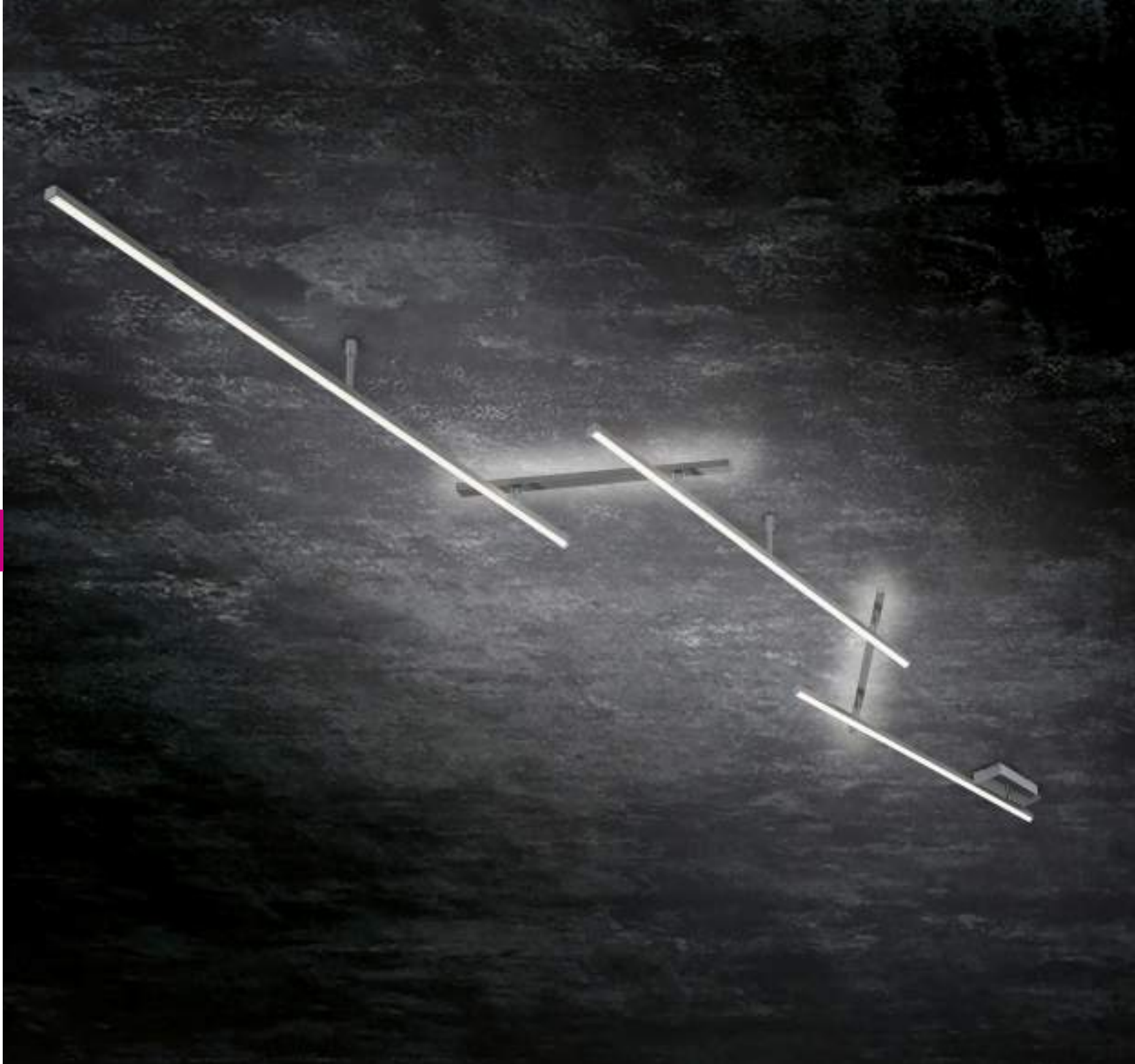

INDIRA

Metall, Nickel matt, Acryl · metal, nickel mat, acryl ·
 metale, nickel mat, acryl · metaal, nikkell mat, acryl · metal, níquel mate, acrílico ·
 metallo, nichel opaco, acrílico · metal, nichel mat, acrílico · metalli, harjattu teräs, akryyli ·
 metal, nikiel mat, akryl

Gibt Licht nach oben und unten · up and down lighting ·
 point lumineux en haut et en bas · lichtpunt boven en onder · luz de arriba y abajo ·
 luce su e giù · sus și în jos lumina · ylös ja alas valoa · w górę iw dół światło

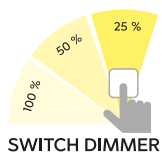

Deckenleuchte · Ceiling lamp

↔ max. 245 cm, ↑ 6,5 cm
 incl. SMD-LED, 25 W
 3.000 lm, 3.000 K



674610507

Deckenleuchte · Ceiling lamp

↔ max. 345 cm, ↑ 6,5 cm
 incl. SMD-LED, 28 W
 3.500 lm, 3.000 K



674610707



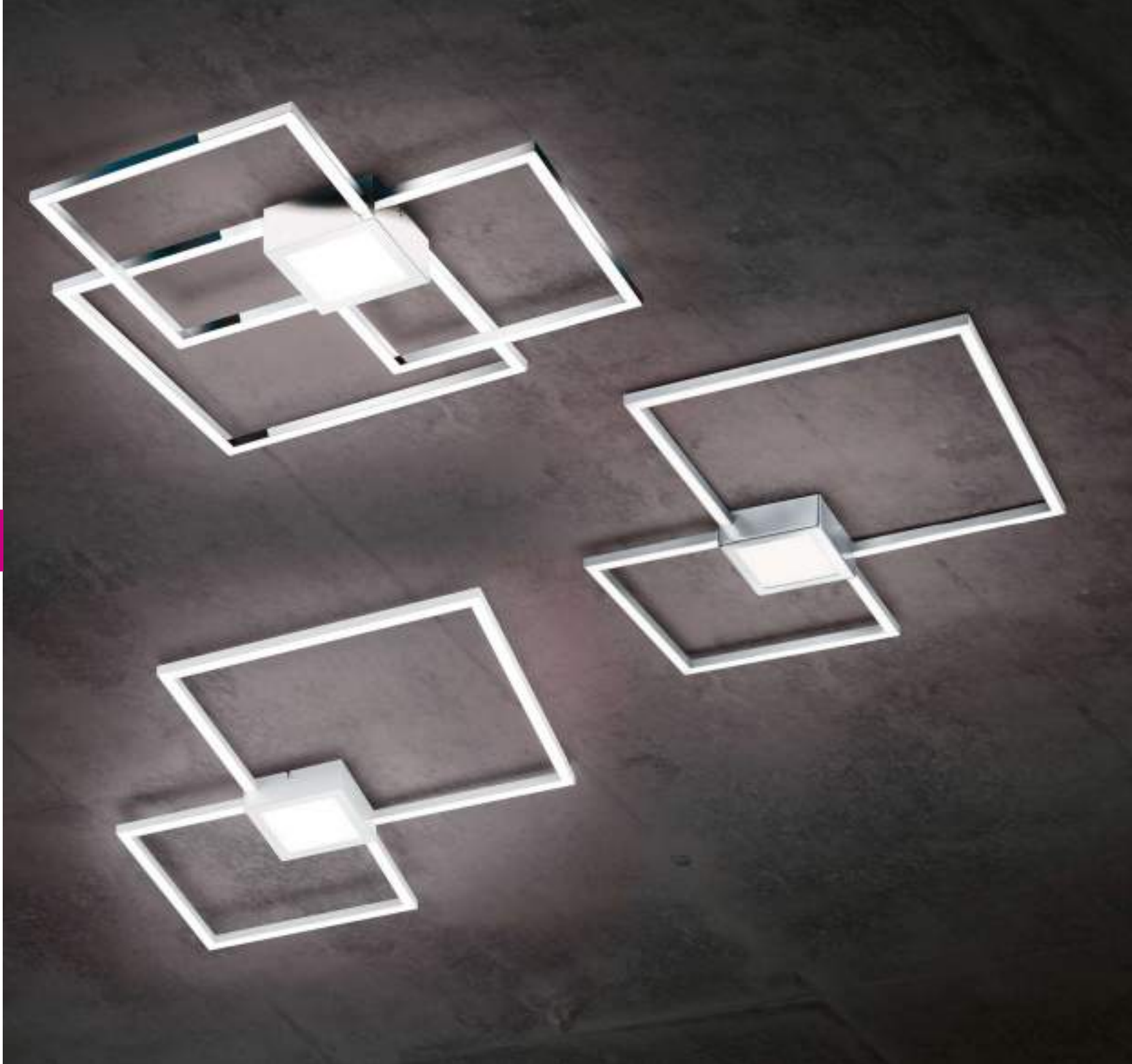

06 | Chrom · chrome



07 | Nickel matt · nickel mat



31 | Weiß matt · white mat

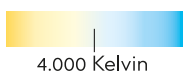

42 | Anthrazit · anthracite

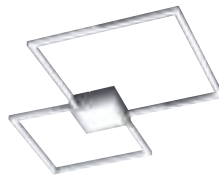

Deckenleuchte · Ceiling lamp
 ↔ 65 x 65 cm, ↑ 5 cm
 incl. SMD-LED, 28 W
 3.200 lm, 4.000 K



676240306
676240331

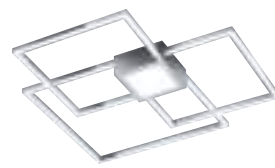

Deckenleuchte · Ceiling lamp
 ↔ 65,5 x 66,5 cm, ↑ 6,5 cm
 incl. SMD-LED, 38 W
 4.400 lm, 4.000 K



676240406
676240431



HYDRA

Chrom, Nickel matt, Weiß matt oder Anthrazit · chrome, nickel mat, white mat or anthracite ·
 chrome, nickel mat, blanc mat ou anthracite · chrom, nikkell mat, wit mat of antraciet ·
 cromo, níquel mate, estera blanca o antracita · cromo, nichel opaco, bianco opaco o antracite ·
 crom, nichel mat, alb mat sau antracit · kromi, harjattu teräs, mattavalkoinen tai antrasiitti ·
 chrom, nikiel mat, biały mat lub antracyt

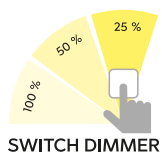

Deckenleuchte · Ceiling lamp
 ↔ 65 x 65 cm, ↑ 5 cm
 incl. SMD-LED, 28 W
 2.600 lm, 3.000 K



676210307
676210342

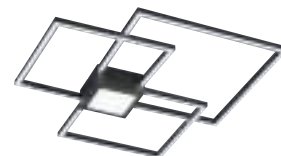

Deckenleuchte · Ceiling lamp
 ↔ 65,5 x 66,5 cm, ↑ 6,5 cm
 incl. SMD-LED, 38 W
 4.000 lm, 3.000 K



676210407
676210442

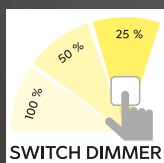

OXFORD

Metall, Nickel matt, Weiß matt oder Anthrazit · metal, nickel mat, white mat or anthracite ·
 metale, nickel mat, blanc mat ou antracite · metaal, nikkel mat, wit mat of antraciet · metal, níquel mate, estera blanca o antracita ·
 metallo, nichel opaco, bianco opaco o antracite · metal, nichel mat, alb mat sau antracit · metalli, harjattu teräs, mattavalkoinen tai antrasiitti ·
 metal, nikiel mat, biały mat lub antracyt



07 | Nickel matt · nickel mat



31 | Weiß matt · white mat

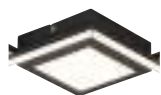

42 | Anthrazit · anthracite

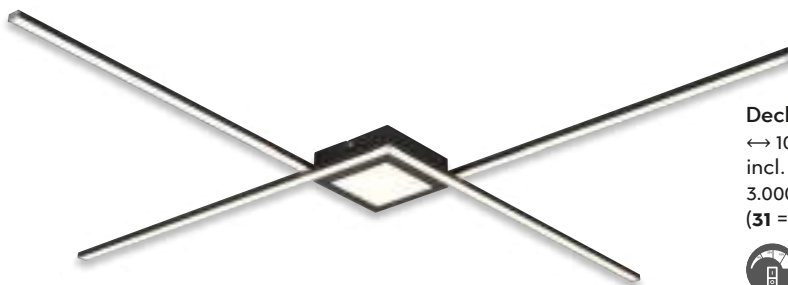

Deckenleuchte · Ceiling lamp

↔ 102 x 78 cm, ↓ 5 cm
 incl. SMD-LED, 27 W
 3.000 lm, 3.000 K
 (31 = 3.300 lm, 4.000 K)



674410307

674410331

674410342



DOWNEY

Metall, Acryl · metal, acryl ·
 metale, acryl · metaal, acryl · metal, acrílico ·
 metallo, acrilico · metal, acrylic · metalli, akryyli · metal, akryl

 Lichtfarbe stufenlos einstellbar ·
 Light color infinitely variable

 Integrierter Dimmer ·
 Integrated dimmer

 Memory Funktion ·
 Memory function

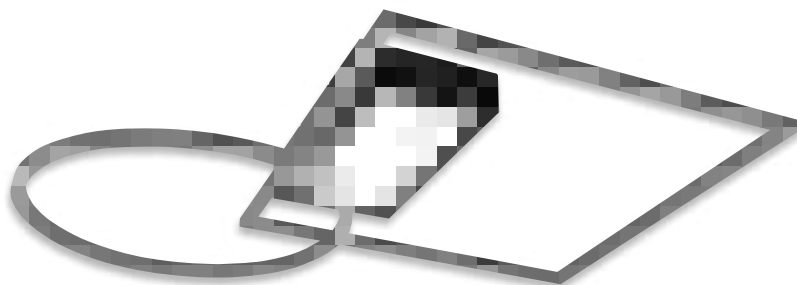

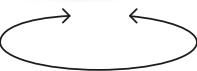
 Schwenkbar · tiltable

Deckenleuchte · Ceiling lamp

↔ 64,5 x 86,5 cm, ↑ 89 cm
 incl. SMD-LED, 33 W
 4.600 lm, 2.700 - 6.500 K



620510307 | Nickel matt · nickel mat

620510331 | Weiß matt · white mat

620510332 | Schwarz matt · black mat



Getrennt schaltbar · Separately switchable

1x



2x



3x



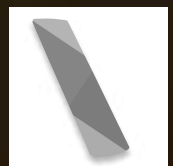

VERUS

Metall, Acryl · metal, acryl ·
metale, acryl · metaal, acryl · metal, acrílico ·
metallo, acrilico · metal, acrilic · metalli, akryyli · metal, akryl



Lichtfarbe stufenlos einstellbar ·
Light color infinitely variable



Integrierter Dimmer ·
Integrated dimmer



07 | Nickel matt · nickel mat



32 | Schwarz matt · black mat



Deckenleuchte · Ceiling lamp

Ø 50 cm, ↓ 7,2 cm
incl. SMD-LED, 44 W
5.300 lm, 3.000 K
incl. SMD-LED, 20 W
2.000 lm, 3.000 K



626910307
626910332



Deckenleuchte · Ceiling lamp

Ø 70 cm, ↓ 7,2 cm
incl. SMD-LED, 70 W
8.400 lm, 3.000 K
incl. SMD-LED, 25 W
2.500 lm, 3.000 K



626919307
626919332



TITUS

Metall, Weiß matt · metal, white mat ·
 metale, blanc mat · metaal, wit mat · metal, estera blanca ·
 metallo, bianco opaco · metal, alb mat · metalli, valkoinen matto ·
 metal, biały mat



Lichtfarbe stufenlos einstellbar ·
 Light color infinitely variable



Integrierter Dimmer ·
 Integrated dimmer

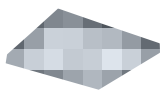

Deckenleuchte · Ceiling lamp
 ↔ 50 x 50 cm, ↓ 4,5 cm
 incl. SMD-LED, 22 W
 2.100 lm, 3.000 - 6.000 K



676615031

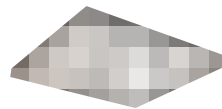

Deckenleuchte · Ceiling lamp
 ↔ 75 x 75 cm, ↓ 4,5 cm
 incl. SMD-LED, 36 W
 3.300 lm, 3.000 - 6.000 K



676617531

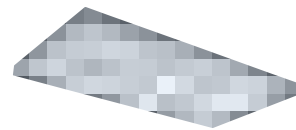

Deckenleuchte · Ceiling lamp
 ↔ 110 x 60 cm, ↓ 4,5 cm
 incl. SMD-LED, 48 W
 4.300 lm, 3.000 - 6.000 K



676611031



RUBY

Metall Weiß matt · metal white mat ·
 metale blanc mat · metaal wit mat ·
 metal estera blanca · metallo bianco opaco ·
 metal alb mat · metalli valkoinen matto ·
 metal biały mat



Dimmbar ·
 Dimmable



Deckenleuchte · Ceiling lamp

↔ 35 x 35 cm, ↓ 11 cm
 incl. SMD-LED, 18 W
 1.800 lm, 3.000 K



623810431

RAVEN

Schiefer, Schwarz · Shale, black ·
Ardoise, noir · Leisteen, zwart · Pizarra, negro ·
Ardesia, nero · Ardezie, negru · Savi, musta · łupek, czarny

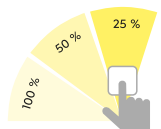

SWITCH DIMMER



indirekte Beleuchtung ·
indirect lighting



Wandleuchte · Wall lamp
Ø 20 cm, ⌈ 3,6 cm
incl. SMD-LED, 9 W
1.000 lm, 3.000 K



224290102



Wandleuchte · Wall lamp
↔ 25 x 12 cm, ⌈ 3,6 cm
incl. SMD-LED, 9 W
1.000 lm, 3.000 K



224210102

CORBIE

Schiefer, Schwarz · Shale, black ·
Ardoise, noir · Leisteen, zwart · Pizarra, negro · Ardesia, nero ·
Ardezie, negru · Savi, musta · łupek, czarny

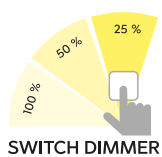

Wandleuchte · Wall lamp
Ø 40 cm, ↗ 6,4 cm
incl. SMD-LED, 27 W
3.100 lm, 3.000 K



672810202

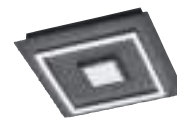

Wandleuchte · Wall lamp
↔ 40 x 40 cm, ↓ 6,4 cm
incl. SMD-LED, 31 W
3.600 lm, 3.000 K



672819202

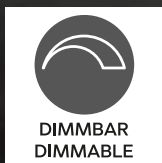
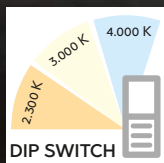

Lichtfarben direkt an der Leuchte einstellbar ·
 Colours directly adjustable at the lamp ·
 Les couleurs de la lumière peuvent être réglées directement sur le luminaire ·
 Lichtkleuren direct instelbaar op de lamp ·
 Tonalidades de luz ajustables directamente en la lámpara ·
 Colori della luce regolabili direttamente sulla lampada ·
 Culori ale luminii reglabile direct de la bec ·
 Valon väri asetettävissa suoraan valaisimesta ·
 Barwy światła można ustawić bezpośrednio na oprawie



2.300 K



3.000 K



4.000 K



WACO

Metall, Acryl · metal, acryl ·
 metale, acryl · metaal, acryl · metal, acrílico ·
 metallo, acrilico · metal, acrylic · metalli, akryyli · metal, akryl



31 | Weiß matt · white mat

32 | Schwarz matt · black mat

87 | titanfarbig · titan



Deckenleuchte · Ceiling lamp
 Ø 31 cm, ↑ 6,5 cm
 incl. SMD-LED, 28 W
 3.200 lm, 2.300 + 3.000 + 4.000 K



627413031
 627413032
 627413087



Deckenleuchte · Ceiling lamp
 Ø 49,5 cm, ↑ 6,5 cm
 incl. SMD-LED, 52,5 W
 6.200 lm, 2.300 + 3.000 + 4.000 K



627415031
 627415032
 627415087



Deckenleuchte · Ceiling lamp
 Ø 75 cm, ↑ 7 cm
 incl. SMD-LED, 100 W
 10.000 lm, 2.300 + 3.000 + 4.000 K



627417531
 627417532
 627417587



Deckenleuchte · Ceiling lamp
 Ø 30 cm, ↑ 4,2 cm
 incl. SMD-LED, 15 W
 1.700 lm, 3.000 K



674093032



Deckenleuchte · Ceiling lamp
 Ø 45 cm, ↑ 4,2 cm
 incl. SMD-LED, 26 W
 3.000 lm, 3.000 K



674094532



Deckenleuchte · Ceiling lamp
 Ø 62 cm, ↑ 4,2 cm
 incl. SMD-LED, 31 W
 3.600 lm, 3.000 K



674096232



Deckenleuchte · Ceiling lamp
 ↔ 30 x 30 cm, ↑ 4,2 cm
 incl. SMD-LED, 15 W
 1.700 lm, 3.000 K



674013032



PHOENIX

Metall, Schwarz matt, Acryl · metal, black mat, acryl ·
 métal, noir mat, acryl · metaal, mat zwart, acryl · metal, estera negra, acrílico ·
 metallo, nero opaco, acrilico · metal, negru mat, acrilic · metalli, mattamusta, akryyli ·
 metal, czarny mat, akryl



Dimmbar ·
Dimmable



Deckenleuchte · Ceiling lamp
 ↔ 45 x 45 cm, ↓ 4,2 cm
 incl. SMD-LED, 26 W
 3.000 lm, 3.000 K



674014532



Deckenleuchte · Ceiling lamp
 ↔ 62 x 62 cm, ↓ 4,2 cm
 incl. SMD-LED, 31 W
 3.600 lm, 3.000 K



674016232



Deckenleuchte · Ceiling lamp
 ↔ 120 x 30 cm, ↓ 4,2 cm
 incl. SMD-LED, 31 W
 3.600 lm, 3.000 K



674011232



Deckenleuchte · Ceiling lamp
 Ø 30 cm, ↑ 4,2 cm
 incl. SMD-LED, 15 W
 1.700 lm, 3.000 K



674093007



Deckenleuchte · Ceiling lamp
 Ø 45 cm, ↑ 4,2 cm
 incl. SMD-LED, 26 W
 3.000 lm, 3.000 K



674094507



Deckenleuchte · Ceiling lamp
 Ø 62 cm, ↑ 4,2 cm
 incl. SMD-LED, 31 W
 3.600 lm, 3.000 K



674096207



Deckenleuchte · Ceiling lamp
 ↔ 30 x 30 cm, ↑ 4,2 cm
 incl. SMD-LED, 15 W
 1.700 lm, 3.000 K



674013007



PHOENIX

Metall, Nickel matt, Acryl · metal, nickel mat, acryl ·
 métal, nickel mat, acryl · metaal, nikkel mat, acryl · metal, níquel mate, acrílico ·
 metallo, nichel opaco, acrílico · metal, nichel mat, acrilic · metalli, harjattu teräs, akryyli ·
 metal, nikiel mat, akryl



Dimmbar ·
Dimmable



Deckenleuchte · Ceiling lamp
 ↔ 45 x 45 cm, ↓ 4,2 cm
 incl. SMD-LED, 26 W
 3.000 lm, 3.000 K



674014507



Deckenleuchte · Ceiling lamp
 ↔ 62 x 62 cm, ↓ 4,2 cm
 incl. SMD-LED, 31 W
 3.600 lm, 3.000 K



674016207



Deckenleuchte · Ceiling lamp
 ↔ 120 x 30 cm, ↓ 4,2 cm
 incl. SMD-LED, 31 W
 3.600 lm, 3.000 K



674011207

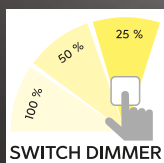

31 | Weiß matt · white mat



4.000 Kelvin



32 | Schwarz matt · black mat



Deckenleuchte · Ceiling lamp

Ø 45 cm, ↑ 11 cm

incl. SMD-LED, 27 W

3.200 lm, 3.000 K

(**31** = 3.200 lm, 4.000 K)



671210131

671210132



GIRONA

Metall, Acryl · metal, acryl ·
metale, acryl · metaal, acryl · metal, acrílico ·
metalho, acrílico · metal, acrílico · metalli, akryyli · metal, akryl

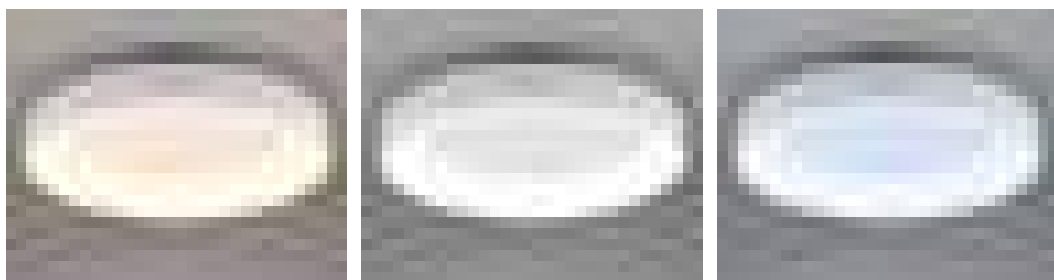

2.700 K

6.500 K



Deckenleuchte · Ceiling lamp

Ø 60 cm, ↓ 12 cm

incl. SMD-LED, 48 W

5.600 lm, 2.700 - 6.000 K



671290131

671290132



ZEUS

Metall, Nickel matt oder Weiß matt · metal, nickel mat or white mat ·
 metale, nickel mat ou blanc mat · metaal, nikkel mat of wit mat · metal, níquel mate o estera blanca ·
 metallo, nichel opaco o bianco opaco · metal, nichel mat sau alb mat · metalli, harjattu teräs tai mattavalkoinen ·
 metal, nikiel mat lub biały mat



01 | Weiß · white



07 | Nickel matt · nickel mat

Deckenleuchte · Ceiling lamp
 ↔ 12 x 12 cm, ↑ 3,5 cm
 incl. SMD-LED, 5,5 W
 500 lm, 3.000 K

657110601
 657110607

Deckenleuchte · Ceiling lamp
 ↔ 18 x 18 cm, ↑ 3,5 cm
 incl. SMD-LED, 15 W
 1.500 lm, 3.000 K

657111201
 657111207

Deckenleuchte · Ceiling lamp
 ↔ 22,5 x 22,5 cm, ↑ 3,5 cm
 incl. SMD-LED, 18 W
 1.900 lm, 3.000 K

657111801
 657111807



CENTO

Metall, Nickel matt oder Weiß matt · metal, nickel mat or white mat ·
 metale, nickel mat ou blanc mat · metaal, nikkel mat of wit mat · metal, níquel mate o estera blanca ·
 metallo, nichel opaco o bianco opaco · metal, nichel mat sau alb mat · metalli, harjattu teräs tai mattavalkoinen ·
 metal, nikiel mat lub biały mat



01 | Weiß · white



07 | Nickel matt · nickel mat

Deckenleuchte · Ceiling lamp
 Ø 12 cm, ↑ 3,5 cm
 incl. SMD-LED, 5,5 W
 500 lm, 3.000 K

657010601
 657010607

Deckenleuchte · Ceiling lamp
 Ø 18 cm, ↑ 3,5 cm
 incl. SMD-LED, 11,5 W
 1.100 lm, 3.000 K

657011201
 657011207

Deckenleuchte · Ceiling lamp
 Ø 22,5 cm, ↑ 3,5 cm
 incl. SMD-LED, 18 W
 1.900 lm, 3.000 K

657011801
 657011807



FERNANDO

Metall, Weiß matt oder Schwarz matt · metal, white mat or black mat ·
 metale, blanc mat ou noir mat · metaal, wit mat of mat zwart ·
 metal, estera blanca o estera negra · metallo, bianco opaco o nero opaco ·
 metal, alb mat sau negru mat · metalli, valkoinen matto tai musta matto ·
 metal, biały mat lub czarny mat

Empfohlen:

recommended: LED GU10, 5 W
 400 lm, 3.000 K



956-5936



31 | Weiß matt · white mat



32 | Schwarz matt · black mat



Deckenleuchte · Ceiling lamp

↔ 23 x 20 cm, ↓ 15 cm
 excl. 3 x GU10, max. 35 W



604900331
 604900332



Deckenleuchte · Ceiling lamp

↔ 37 x 30 cm, ↓ 15 cm
 excl. 6 x GU10, max. 35 W



604900631
 604900632

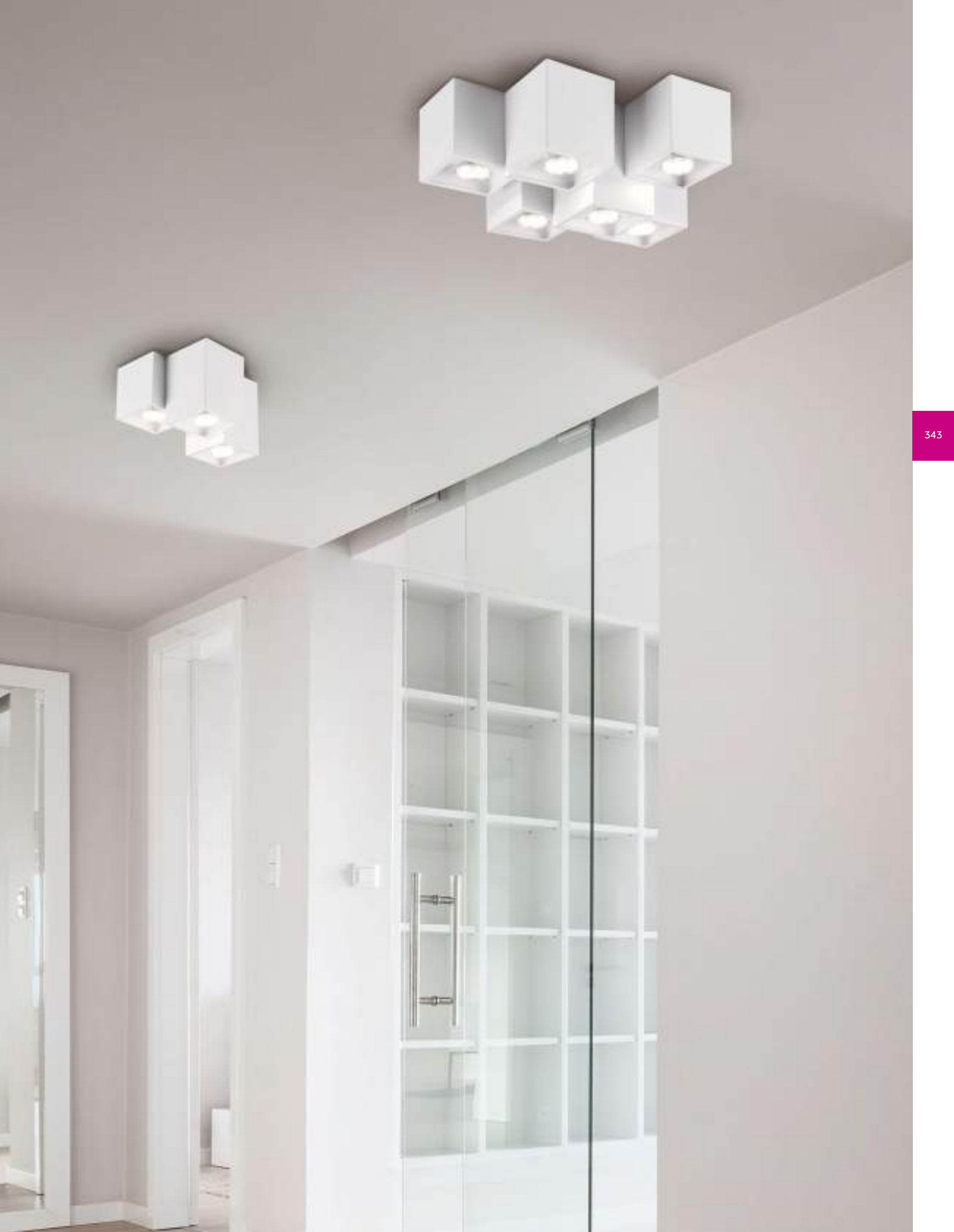



COOKIE

Metall, Weiß matt oder Schwarz matt · metal, white mat or black mat ·
 metale, blanc mat ou noir mat · metaal, wit mat of mat zwart · metal, estera blanca o estera negra · metallo, bianco opaco o nero opaco ·
 metal, alb mat sau negru mat · metalli, valkoinen matto tai musta matto · metal, biały mat lub czarny mat



Deckenleuchte · Ceiling lamp
 Ø 9,6 cm, ↓ 12,5 cm
 excl. 1 x GU10, max. 35 W



612900131
 612900132



Deckenleuchte · Ceiling lamp
 ↔ 17,8 x 9,6 cm, ↓ 12,5 cm
 excl. 2 x GU10, max. 35 W



612900231
 612900232



Deckenleuchte · Ceiling lamp
 ↔ 17,8 x 17,8 cm, ↓ 12,5 cm
 excl. 4 x GU10, max. 35 W



612900431
 612900432

Empfohlen:

recommended: LED GU10, 5 W
 400 lm, 3.000 K



956-5936



BISCUIT

Metall, Weiß matt oder Schwarz matt · metal, white mat or black mat ·
 metale, blanc mat ou noir mat · metaal, wit mat of mat zwart · metal, estera blanca o estera negra · metallo, bianco opaco o nero opaco ·
 metal, alb mat sau negru mat · metalli, valkoinen matto tai musta matto · metal, biały mat lub czarny mat



31 | Weiß matt · white mat

Deckenleuchte · Ceiling lamp
 ↔ 9,6 x 9,6 cm, ↓ 12,5 cm
 excl. 1 x GU10, max. 35 W



613000131
 613000132



32 | Schwarz matt · black mat

Deckenleuchte · Ceiling lamp
 ↔ 17,8 x 9,6 cm, ↓ 12,5 cm
 excl. 2 x GU10, max. 35 W



613000231
 613000232

Deckenleuchte · Ceiling lamp
 ↔ 17,8 x 17,8 cm, ↓ 12,5 cm
 excl. 4 x GU10, max. 35 W



613000431
 613000432

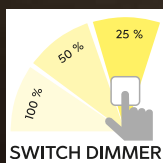

LUGANO

Stoffschild, Acryl · fabric shade, acryl ·
abat-jour tissu, acryl · Stoffen kap, acryl · Pantalla de tela, acrílico ·
paralume in tessuto, acrilico · abajur textil, acrilic · kangas varjostin, akryyli ·
Klosz z materiału, akryl



01 | Weiß · white



11 | Grau · grey



Deckenleuchte · Ceiling lamp
Ø 30 cm, ↑ 9 cm
incl. SMD-LED, 11 W
1.200 lm, 3.000 K

621911201
621911211



Deckenleuchte · Ceiling lamp
Ø 40 cm, ↑ 10,5 cm
incl. SMD-LED, 22 W
2.200 lm, 3.000 K



621912401
621912411



Lichtfarbe stufenlos einstellbar ·
Light color infinitely variable



Integrierter Dimmer ·
Integrated dimmer



Memory Funktion ·
Memory function



Deckenleuchte · Ceiling lamp
Ø 60 cm, ↑ 10 cm
incl. SMD-LED, 42 W
4.900 lm, 3.000 - 5.000 K



621914001
621914011



Deckenleuchte · Ceiling lamp
Ø 75 cm, ↑ 10 cm
incl. SMD-LED, 60 W
5.000 lm, 3.000 - 5.000 K



621915501
621915511

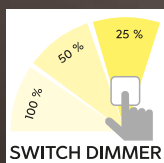

LUGANO

Stoffschild, Acryl · fabric shade, acryl ·
abat-jour tissu, acryl · Stoffen kap, acryl ·
Pantalla de tela, acrílico · paralume in tessuto, acrílico ·
abajur textil, acrílic · kangas varjostin, akryyli ·
Klosz z materiału, akryl



01 | Weiß · white



02 | Schwarz · black



17 | mehrfarbig · multicolor

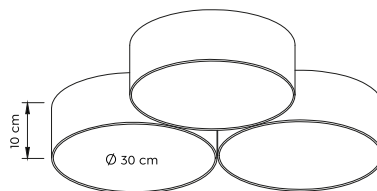

Deckenleuchte · Ceiling lamp

↔ 64,5 x 64,5 cm, ↑ 14 cm
incl. SMD-LED, 38 W
4.200 lm, 3.000 K



621910301
621910302
621910317

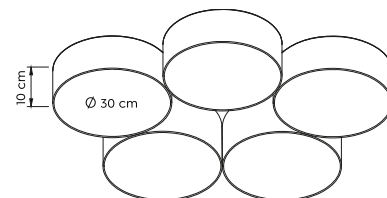

Deckenleuchte · Ceiling lamp

↔ 86,5 x 69 cm, ↑ 14 cm
incl. SMD-LED, 58 W
6.300 lm, 3.000 K



621910501
621910502
621910517







CRYSTEL

Chrom, Glas chrom bedampft, Acryl · chrome, chrome plated glass, acryl ·
 Chrome, Verre plaqué chrome, Acryl · Chroom, Chroom opgedampt glas, Acryl · Cromo, Vidrio cromado, Acrílico ·
 Cromo, Vetro verniciato cromo, Acrilico · Crom, Sticla cromata, Acrilic · Kromi, Kromipäällystetty lasi, Akryyli ·
 Chrom, Szkło chromowane, Akryl

Empfohlen:
 recommended: Filament LED E14, 4 W
 470 lm, 2.700 K



983-400



Deckenleuchte · Ceiling lamp
 Ø 34 cm, ↓ 17,5 cm
 excl. 3 x E14, max. 28 W



616700306



Deckenleuchte · Ceiling lamp
 Ø 50 cm, ↓ 23,5 cm
 excl. 5 x E14, max. 28 W



616700506

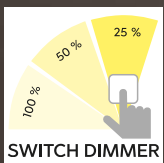

BULLET

Metall, Glas · metal, glass ·
 metale, verre · metaal, glas · metal, vidrio ·
 metallo, vetro · metal, sticla · metalli, lasi · metal, szkło



06 | Chrom, Glas chrom bedampft ·
 chrome, chrome plated glass



07 | Nickel matt, Glas weiß matt ·
 nickel mat, white mat glass



32 | Schwarz matt, Glas weiß matt ·
 black mat, white mat glass

Deckenleuchte · Ceiling lamp
 Ø 100 cm, ↑ 15,8 cm
 incl. 21 x SMD-LED, 1,5 W
 21 x 170 lm, 3.000 K



641412106
 641412107
 641412132





PEACOCK

Metall, schwarz matt · metal, black mat ·
 metale, noir mat · metaal, mat zwart · metal, estera negra · metallo, nero opaco ·
 metal, negru mat · metalli, mattamusta · metal, czarny mat

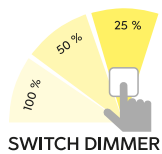

SWITCH DIMMER

Deckenleuchte · Ceiling lamp

↔ 115 x 97,5 cm, ↓ 10,5 cm
 incl. 15 x SMD-LED, 2,6 W
 15 x 270 lm, 3.000 K



679511532



BODRUM

Chrom · chrome ·
chrome · chroom · cromo · cromo · crom · kromi · chrom · krom



Lichtfarbe stufenlos einstellbar ·
Light color infinitely variable



Memory Funktion ·
Memory function



3.000 K

6.500 K

Deckenleuchte · Ceiling lamp

Ø 100 cm, ↑ 8,5 cm

incl. 12 x SMD-LED, 2,2 W

12 x 250 lm, 3.000 - 6.500 K

incl. 1 x SMD-LED, 5 W

550 lm, 3.000 - 6.500 K



673311306



MITA

Metall Weiß matt, Acryl · metal white mat, acryl ·
 metale blanc mat, acryl · metaal wit mat, acryl ·
 metal estera blanca, acrílico · metallo bianco opaco, acrilico ·
 metal alb mat, acrilic · metalli valkoinen matto, akryyli · metal biały mat, akryl



Lichtfarbe stufenlos einstellbar ·
 Light color infinitely variable



Integrierter Dimmer ·
 Integrated dimmer



2.700 K

6.000 K



Deckenleuchte · Ceiling lamp
 Ø 51 cm, ↑ 7 cm
 incl. SMD-LED, 74 W
 9.000 lm, 2.700 - 6.000 K



629210331



Deckenleuchte · Ceiling lamp
 ↔ 51,5 x 51,5 cm, ↑ 7 cm
 incl. SMD-LED, 76 W
 9.250 lm, 2.700 - 6.000 K



629219331





KAGAWA

Metall Weiß matt, Acryl · metal white mat, acryl ·
 metale blanc mat, acryl · metaal wit mat, acryl ·
 metal estera blanca, acrílico · metallo bianco opaco, acrilico ·
 metal alb mat, acrilic · metalli valkoinen matto, akryyli · metal biały mat, akryl



Lichtfarbe stufenlos einstellbar ·
 Light color infinitely variable



Memory Funktion ·
 Memory function



Nachtlicht ·
 Night light



Deckenleuchte · Ceiling lamp
 Ø 50 cm, ↓ 6 cm
 incl. SMD-LED, 40 W
 5.000 lm, 2.700 - 6.000 K



625815031



SUBARA

Metall Weiß matt, Acryl · metal white mat, acryl ·
 metale blanc mat, acryl · metaal wit mat, acryl ·
 metal estera blanca, acrílico · metallo bianco opaco, acrilico ·
 metal alb mat, acrilic · metalli valkoinen matto, akryyli · metal biały mat, akryl

 Lichtfarbe stufenlos einstellbar ·
 Light color infinitely variable

 Memory Funktion ·
 Memory function



Deckenleuchte · Ceiling lamp
 ↔ 40 x 26 cm, ↑ 5,6 cm
 incl. SMD-LED, 20 W
 2.100 lm, 3.000 + 4.000 K



274510107



Deckenleuchte · Ceiling lamp
 ↔ 88 x 58 cm, ↑ 6,4 cm
 incl. SMD-LED, 58 W
 5.400 lm, 3.000 - 5.500 K



674510107

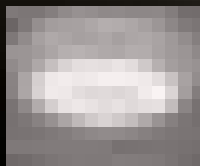

3.000 K

5.500 K

OSAKA

Chrom, Acryl, Starlight-Effekt · chrome, acryl, starlight effect ·
 chrome, acryl, effet étoile · chrom, acryl, sterlicht effect · cromo, acrílico, efecto de la luz · cromo, acrilico, effetto di stelle ·
 crom, acrilic, efect lumina stelelor · kromi, akryyli, starlight vaikutus · chrom, akryl, efekt starlight



Deckenleuchte · Ceiling lamp
 Ø 21 cm, ↓ 5 cm
 incl. SMD-LED, max. 12 W
 max. 1.160 lm, 3.000 K



678711206



Deckenleuchte · Ceiling lamp
 Ø 42 cm, ↓ 7 cm
 incl. SMD-LED, max. 27 W
 max. 3.100 lm, 3.000 - 5.500 K



678713006

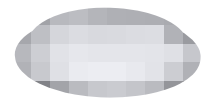

Deckenleuchte · Ceiling lamp
 Ø 67 cm, ↓ 10 cm
 incl. SMD-LED, max. 91,5 W
 max. 11.000 lm, 3.000 - 5.500 K



678710006

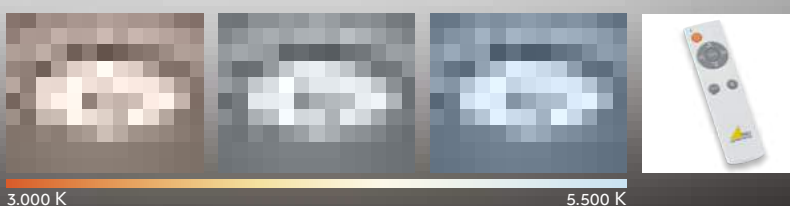
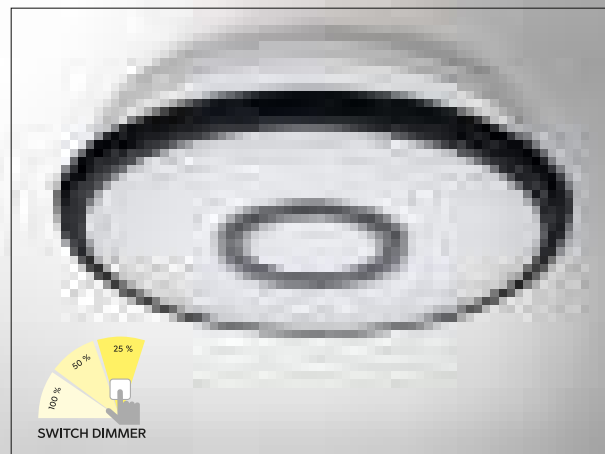

OKINAWA

Metall, Acryl, Schwarz matt · metal, acryl, black mat ·
 metale, acryl, noir mat · metaal, acryl, mat zwart · metal, acrílico, estera negra ·
 metallo, acrilico, nero opaco · metal, acrilic, negru mat · metalli, akryyli, mattamusta · metal, akryl, czarny mat



Deckenleuchte · Ceiling lamp
 Ø 21 cm, ↓ 5 cm
 incl. SMD-LED, 12 W
 1.160 lm, 3.000 K



679112132



Deckenleuchte · Ceiling lamp
 Ø 42 cm, ↓ 7,5 cm
 incl. SMD-LED, 18 W
 1.800 lm, 3.000 - 5.500 K



679114232



Deckenleuchte · Ceiling lamp
 Ø 65 cm, ↑ 10 cm
 incl. SMD-LED, 45 W
 5.300 lm, 3.000 - 5.500 K



679110032

SEIKO

Acryl, Starlight-Effekt · acryl, starlight effect ·
acryl, effet étoile · acryl, sterlicht effect ·
acrílico, efecto de la luz · acrilico, effetto di stelle ·
acrilic, efect lumina stelelor · akryyli, starlight vaikutus ·
akryl, efekt starlight



Lichtfarbe stufenlos einstellbar ·
Light color infinitely variable



Memory Funktion ·
Memory function

362

Deckenleuchte · Ceiling lamp

Ø 42,5 cm, ↑ 6 cm
incl. SMD-LED, 21,5 W
2.400 lm, 3.000-5.500 K



678513001

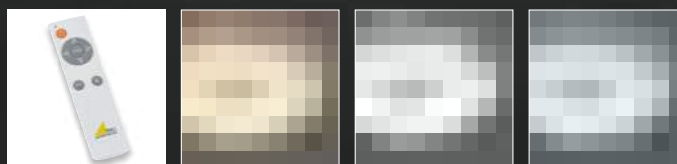

TOKYO

Acryl · acryl ·
acryl · acryl · acrílico · acrilico · acrilic · akryyli · akryl



Lichtfarbe stufenlos einstellbar ·
Light color infinitely variable



Memory Funktion ·
Memory function

Deckenleuchte · Ceiling lamp

Ø 60 cm, ↑ 6,5 cm
incl. SMD-LED, 45 W
4.000 lm, 3.000 - 5.500 K



628915001





MIKO

Chrom, Acryl, Starlight-Effekt · chrome, acryl, starlight effect ·
 chrome, acryl, effet étoile · chrom, acryl, sterlicht effect · cromo, acrílico, efecto de la luz ·
 cromo, acrilico, effetto di stelle · crom, acrilic, efect lumina stelelor · kromi, akryyli, starlight vaikutus ·
 chrom, akryl, efekt starlight · krom, akrilik, starlight etkisi



Lichtfarbe stufenlos einstellbar ·
 Light color infinitely variable



Integrierter Dimmer ·
 Integrated dimmer



Memory Funktion ·
 Memory function

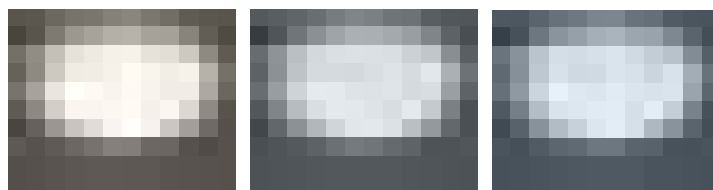

3.000 K

5.500 K

Deckenleuchte · Ceiling lamp

Ø 85 cm, ↑ 12,5 cm
 incl. SMD-LED, 90 W
 10.800 lm, 3.000 - 5.500 K



675610106

SHOGUN

Acryl, Starlight-Effekt · acryl, starlight effect ·
acryl, effet étoile · acryl, sterlicht effect ·
acrílico, efecto de la luz · acrilico, effetto di stelle ·
acrilic, efect lumina stelelor · akryyli, starlight vaikutus ·
akryl, efekt starlight



Lichtfarbe stufenlos einstellbar ·
Light color infinitely variable



Memory Funktion ·
Memory function

Deckenleuchte · Ceiling lamp

Ø 42,5 cm, ↑ 6 cm
incl. SMD-LED, 21,5 W
2.400 lm, 3.000-5.500 K



628513001

364



SAMURAI

Acryl, Starlight-Effekt · acryl, starlight effect ·
acryl, effet étoile · acryl, sterlicht effect ·
acrílico, efecto de la luz · acrilico, effetto di stelle ·
acrilic, efect lumina stelelor · akryyli, starlight vaikutus ·
akryl, efekt starlight



Lichtfarbe stufenlos einstellbar ·
Light color infinitely variable



Memory Funktion ·
Memory function

Deckenleuchte · Ceiling lamp

↔ 42,5 x 42,5 cm, ↑ 6 cm
incl. SMD-LED, 21,5 W
2.400 lm, 3.000-5.500 K



628613001

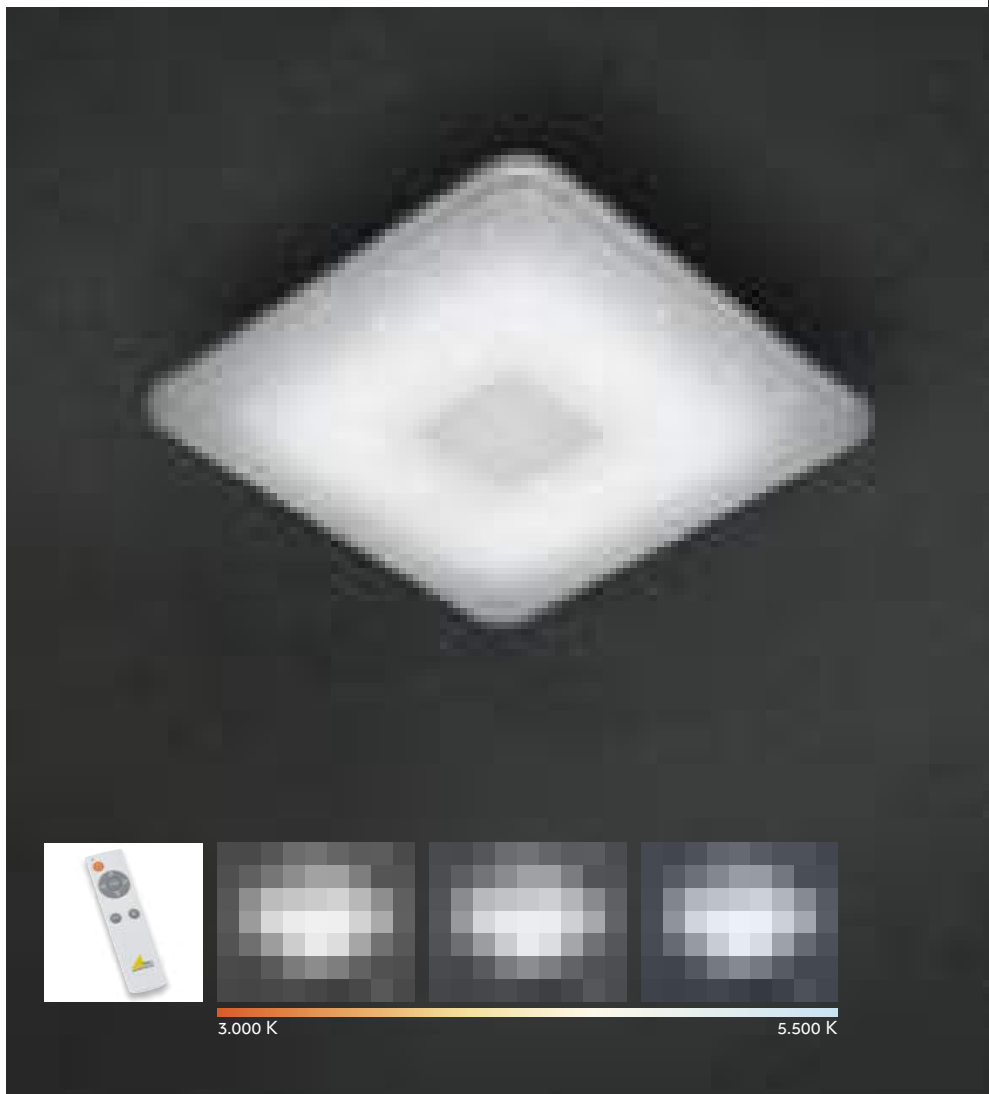

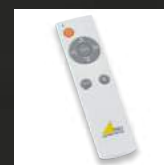



NORIAKI

Chrom, Acryl, Starlight-Effekt · chrome, acryl, starlight effect ·
 chrome, acryl, effet étoile · chroom, acryl, sterlicht effect ·
 cromo, acrílico, efecto de la luz · cromo, acrílico, effetto di stelle ·
 crom, acrílic, efect lumina stelelor · kromi, akryyli, starlight vaikutus ·
 chrom, akryl, efekt starlight

 Lichtfarbe stufenlos einstellbar ·
 Light color infinitely variable

 Integrierter Dimmer ·
 Integrated dimmer

 Memory Funktion ·
 Memory function

 Getrennt schaltbar ·
 Separately switchable



3.000 K

5.500 K

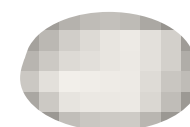

Deckenleuchte · Ceiling lamp

Ø 59,5 cm, ↓ 10 cm
 incl. SMD-LED, 40 W
 4.750 lm, 3.000-5.500 K



679210106

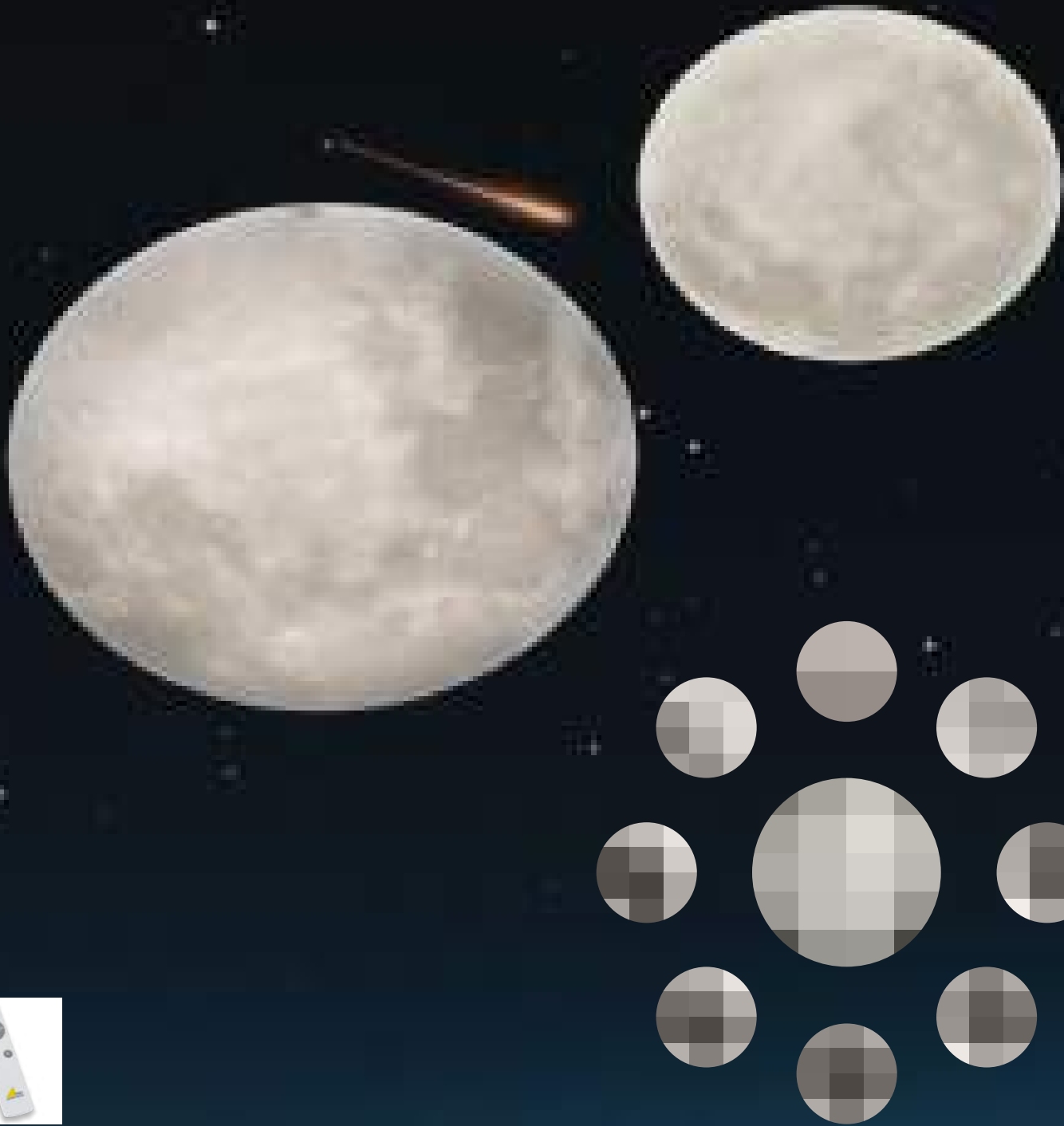

LUNAR

Kunststoff · plastic ·
plastique · kunststof · plástico · plastica · plastic · muovi · plastik · plastik

Mondphasen individuell einstellbar · Phases of the moon individually adjustable ·
Phases de lune réglables · Maanstanden apart instelbaar ·
Fases lunares ajustables individualmente · Fasi lunari regolabili individualmente ·
Fazele lunii reglabile individual · Kuun vaiheet erikseen säädettävissä ·
Cykl księżyca indywidualnie regulowany



Musterschutz ·
Registered model



Integrierter Dimmer ·
Integrated dimmer

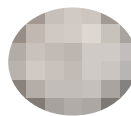

Deckenleuchte · Ceiling lamp
Ø 40 cm, ↑ 10 cm
incl. SMD-LED, 22 W
2.460 lm, 3.000 K



627514000

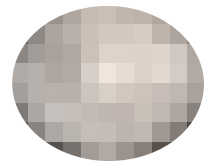

Deckenleuchte · Ceiling lamp
Ø 60 cm, ↑ 12 cm
incl. SMD-LED, 40 W
3.500 lm, 3.000 K



627516000



NAGANO

Acryl, Starlight-Effekt · acryl, starlight effect ·
 acryl, effet étoile · acryl, sterlicht effect · acrílico, efecto de la luz ·
 acrilico, effetto di stelle · acrilic, efect lumina stelelor · akryyli, starlight vaikutus · akryl, efekt starlight



Lichtfarbe stufenlos einstellbar ·
 Light color infinitely variable



Memory Funktion ·
 Memory function

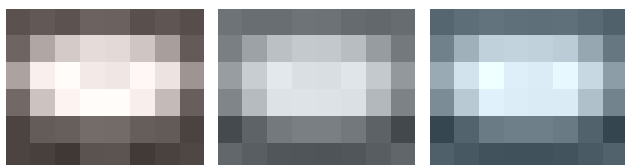

3.000 K

5.500 K

Deckenleuchte · Ceiling lamp

Ø 80 cm, ↑ 10,8 cm
 incl. SMD-LED, max. 72 W
 max. 8.500 lm, 3.000 - 5.500 K



677718000



GONZALO

Kunststoff, Weiß oder titanfarbig · plastic, white or titan ·
 plastique, blanc ou titane · kunststof, wit of titaan · plástico, blanco o titán ·
 plastica, bianco o titano · plastic, alb sau titaniu · muovi, valkoinen tai titaani ·
 plastik, biały lub tytanowy



Dimmbar ·
Dimmable



Deckenleuchte · Ceiling lamp
 Ø 29 cm, ↑ 8 cm
 incl. SMD-LED, 9 W
 900 lm, 3.000 K



626510987



Deckenleuchte · Ceiling lamp
 Ø 34 cm, ↑ 9 cm
 incl. SMD-LED, 12 W
 1.050 lm, 3.000 K



626511287



Deckenleuchte · Ceiling lamp
 Ø 42 cm, ↑ 10 cm
 incl. SMD-LED, 25 W
 2.300 lm, 3.000 K



626512587



CESAR

Chrom, Acryl mit Kristalleffekt · chrome, broken glass optic ·
 chrome, optique verre pilé · chroom, Gebroken glas optiek · cromo, Efecto cristal roto ·
 cromo, effetto ottico vetro rotto · crom, aspect de sticla sparta · kromi, lasi efekti optiikka · chrom, Optyczne rozbite szkło

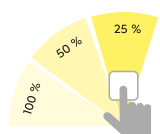

SWITCH DIMMER



Deckenleuchte · Ceiling lamp
 Ø 26 cm, ↑ 3 cm
 incl. SMD-LED, 13 W
 1.500 lm, 3.000 K



656411506



Deckenleuchte · Ceiling lamp
 Ø 40 cm, ↑ 3 cm
 incl. SMD-LED, 22 W
 2.700 lm, 3.000 K



656412406



Deckenleuchte · Ceiling lamp
 ↔ 30 x 30 cm, ↑ 3 cm
 incl. SMD-LED, 16 W
 1.900 lm, 3.000 K



656511806



Deckenleuchte · Ceiling lamp
 ↔ 40 x 40 cm, ↑ 3 cm
 incl. SMD-LED, 22 W
 2.700 lm, 3.000 K



656512006



MOONY

Stoffschirm · fabric shade ·
abat-jour tissu · Stoffen kap · Pantalla de tela ·
paralume in tessuto · abajur textil · kangas varjostin · Klosz z materiału



01 | Weiß · white



45 | Pastellblau · pastel blue



94 | Pastellrosa · pastel pink

Empfohlen:
recommended: LED E27, 6 W
470 lm, 3.000 K



987-60

Deckenleuchte · Ceiling lamp
Ø 40 cm, ↑ 20,5 cm
excl. 3 x E27, max. 10 W



602300301
602300345
602300394



CURVA

Nickel matt, Glas matt · nickel mat, mat glass ·
 nickel mat, verre mat · nikkel mat, mat glas · níquel mate, vidrio mate ·
 nichel opaco, vetro sabbiato · nichel mat, sticla mata · harjattu teräs, mattalasi ·
 nikiel mat, szkło matowane

Empfohlen:
 recommended: LED E14, 4,9 W
 470 lm, 3.000 K



983-60



Deckenleuchte · Ceiling lamp
 ↔ 50 x 20 cm, ↓ 27 cm
 excl. 3 x E14, max. 40 W



605600307



Deckenleuchte · Ceiling lamp
 ↔ 72 x 28 cm, ↓ 27 cm
 excl. 5 x E14, max. 40 W



605600507



QUINTA

rostfarbig, Glas alabasterfarbig · rusty, alabaster-coloured glass ·
 rouille, verre couleur albâtre · roestkleur, albastkleurig glas · óxido, vidrio de color alabastro ·
 ruggine, vetro colore alabastro · ruginiu, sticla culoare alabastru · rustiikki, lasi alabasteri väri · miedź, szkło alabaster kolor



Deckenleuchte · Ceiling lamp
 Ø 33 cm, ↓ 20 cm
 excl. 2 x E27, max. 42 W



608100224



Deckenleuchte · Ceiling lamp
 Ø 42 cm, ↓ 32 cm
 excl. 3 x E27, max. 60 W



608100324



REPOSA

rostfarbig antik, Glas matt · antique rust, mat glass ·
 rouille antique, verre mat · roestkleur antiek, mat glas · oxido, vidrio mate ·
 ruggine anticato, vetro sabbiato · ruginiu antic, sticla mata · rustiikki, mattalasi · antyczny rdzawy, szkło matowane



Deckenleuchte · Ceiling lamp
 Ø 80 cm, ↓ 10,5 cm
 incl. 15 x SMD-LED, 1,1 W
 15 x 115 lm, 3.000 K



622811528



SAESONS

Holz naturbelassen, Stoff · wood natural finish, fabric ·
 bois finition naturelle, tissu · hout natuurlijke afwerking, textiel ·
 madera acabado natural, tela · di legno finitura naturale, tessuto ·
 lemn finisaj natural, textil · puu luonnollinen viimeistely, tekstiili ·
 drewno naturalne wykończenie, tkanina

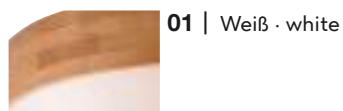

01 | Weiß · white



02 | Schwarz · black



Deckenleuchte · Ceiling lamp
 Ø 30 cm, ↓ 22 cm
 excl. 2 x E14, max. 40 W



611500201
 611500202



Deckenleuchte · Ceiling lamp
 Ø 50 cm, ↓ 22 cm
 excl. 3 x E27, max. 40 W



611500301
 611500302





PALI

Holz, Glas satiniert · wood, satinated glass ·
 bois, Verre satiné · hout, Gesatineerd glas · mader, Vidrio satinado ·
 di legno, Vetro satinato · lemn, Sticla satinata · puu, Satinoitu lasi ·
 drewno, Szkło satynowe



30 | Holz naturbelassen · wood natural finish

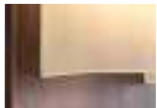

56 | Holz dunkel · old wood



Wandleuchte · Wall lamp
 ↑ 25 x 25 cm, ↗ 9 cm
 excl. 1 x E27, max. 40 W



212600130
212600156



Wandleuchte · Wall lamp
 ↑ 45 x 14 cm, ↗ 10,5 cm
 excl. 2 x E27, max. 40 W



212600230
212600256



Deckenleuchte · Ceiling lamp
 Ø 32 cm, ↓ 9 cm
 excl. 2 x E27, max. 40 W



612600230
612600256

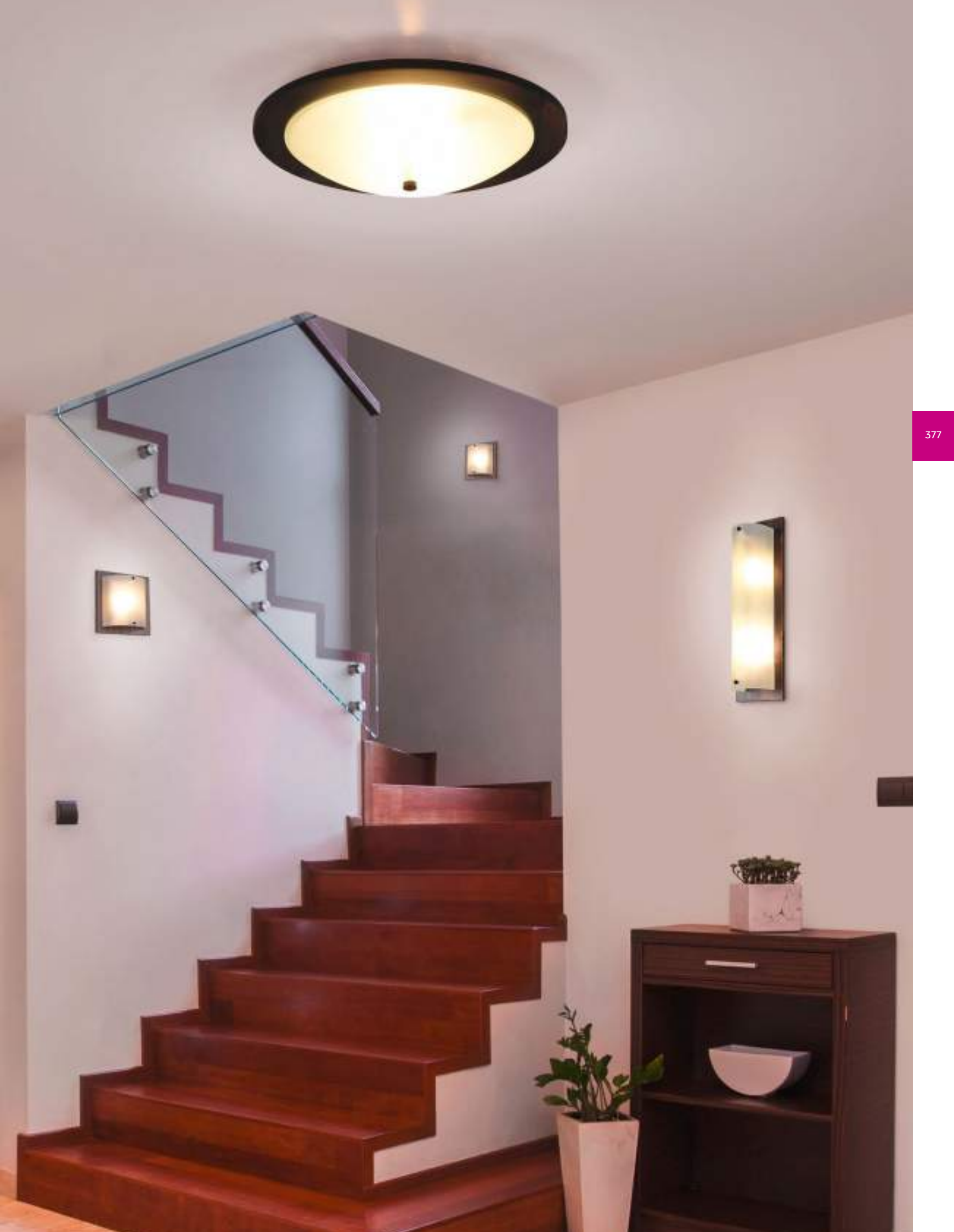

CLEO

Metall, goldfarbig · metal, gold ·
metale, or · metaal, goud · metal, oro · metallo, oro ·
metal, aur · metalli, kultaa · metal, złota

Empfohlen:

recommended: LED GU10, 4,5 W
345 lm, 3.000 K



956-55



Wandleuchte · Wall lamp

↓ 15 x 8 cm, ↗ 8 cm
excl. 2 x GU10, max. 35 W



206500279

Wandleuchte · Wall lamp

↓ 16,5 x 6 cm, ↗ 10 cm
excl. 2 x GU10, max. 35 W



206400279



AURORA

Metall, goldfarbig · metal, gold ·
metale, or · metaal, goud · metal, oro · metallo, oro ·
metal, aur · metalli, kultaa · metal, złota



Wandleuchte · Wall lamp

↗ 12 cm, Ø 20 cm
incl. 1 x SMD-LED, 3,1 W, 310 lm
incl. 1 x SMD-LED, 3 W, 200 lm
3.000 K



223810279





CHIROS

Metall, goldfarbig, Glas satiniert · metal, gold, satinated glass ·
 metale, or, verre satiné · metaal, goud, gesatineerd glas · metal, oro, vidrio satinado ·
 metallo, oro, vetro satinato · metal, aur, sticla satinata · metalli, kultaa, satinoitu lasi ·
 metal, złota, szkło satynowe



Wandleuchte · Wall lamp
 Ø 22 cm, ℓ 6,5 cm
 incl. 1 x SMD-LED, 8 W
 700 lm, 3.000 K



224110179



Deckenleuchte · Ceiling lamp
 Ø 32 cm, ℓ 6 cm
 incl. 1 x SMD-LED, 12 W, 1.280 lm
 incl. 1 x SMD-LED, 3,5 W, 350 lm
 3.000 K

624110279

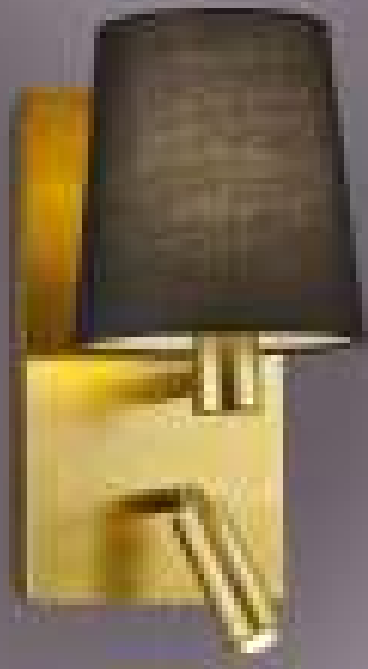

MARRIOT

Nickel matt oder goldfarbig, Stoffschirm · nickel mat or gold, fabric shade ·
 nickel mat ou or, abat-jour tissu · nikkell mat of goud, Stoffen kap · níquel mate o oro, Pantalla de tela ·
 nichel opaco o oro, paralume in tessuto · nichel mat sau aur, abajur textil ·
 harjattu teräs tai kultaa, kangas varjostin · nikiel mat lub złota, Klosz z materiału

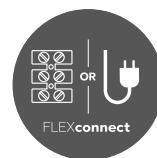

Seite/page 632



07 | Nickel matt · nickel mat



79 | goldfarbig · gold

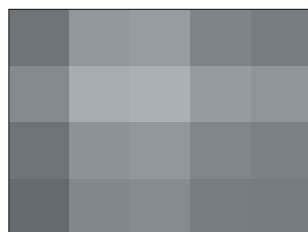

Getrennt schaltbar ·
 Separately switchable

Wandleuchte · Wall lamp
 ↓ 30,8 x 14 cm, ∅ 17,6 cm
 incl. 1 x SMD-LED, 3,1 W
 310 lm, 3.000 K
 excl. 1 x E14, max. 40 W



271470207
 271470279

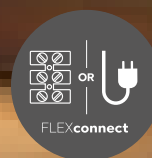
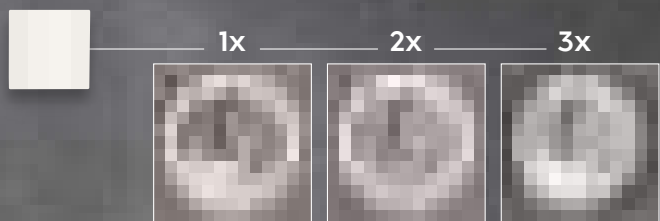

Seite/page 632

JORDAN

Nickel matt, Weiß matt oder Schwarz matt, Acryl · nickel mat, white mat or black mat, acryl ·
 nickel mat, blanc mat ou noir mat, acryl · nikkel mat, wit mat of mat zwart, acryl ·
 níquel mate, estera blanca o estera negra, acrílico · nichel opaco, bianco opaco o nero opaco, acrílico ·
 nichel mat, alb mat sau negru mat, acrilic · harjattu teräs, mattavalkoinen tai mattamusta, akryyli ·
 nikiel mat, biały mat lub czarny mat, akryl



Getrennt schaltbar ·
 Separately switchable



07 | Nickel matt · nickel mat



31 | Weiß matt · white mat



32 | Schwarz matt · black mat

Wandleuchte · Wall lamp

Ø 15 cm, √ 12 cm
 incl. 1 x SMD-LED, 5 W
 550 lm, 3.000 K
 incl. 1 x SMD-LED, 2 W
 200 lm, 3.000 K



229210207
 229210231
 229210232

MARIO

Metall, Weiß matt oder Schwarz matt · metal, white mat or black mat ·
metale, blanc mat ou noir mat · metaal, wit mat of mat zwart ·
metal, estera blanca o estera negra · metallo, bianco opaco o nero
opaco · metal, alb mat sau negru mat · metalli, valkoinen matto
tai musta matto · metal, biały mat lub czarny mat



Getrennt schaltbar ·
Separately switchable

Wandleuchte · Wall lamp

Ø 16 cm, ∅ 10,5 cm
incl. 1 x SMD-LED, 6 W
600 lm, 3.000 K
incl. 1 x SMD-LED, 2,3 W
200 lm, 3.000 K



222370231 | Weiß matt · white mat
222370232 | Schwarz matt · black mat

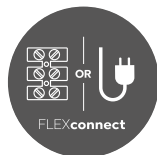

Seite/page 632



LUIGI

Metall, Weiß matt oder Schwarz matt · metal, white mat or black mat ·
metale, blanc mat ou noir mat · metaal, wit mat of mat zwart ·
metal, estera blanca o estera negra · metallo, bianco opaco o nero
opaco · metal, alb mat sau negru mat · metalli, valkoinen matto
tai musta matto · metal, biały mat lub czarny mat



Getrennt schaltbar ·
Separately switchable

Wandleuchte · Wall lamp

↑ 20 x 13,5 cm, ∅ 11 cm
incl. 1 x SMD-LED, 5 W
500 lm, 3.000 K
incl. 1 x SMD-LED, 2,3 W
200 lm, 3.000 K



222270231 | Weiß matt · white mat
222270232 | Schwarz matt · black mat

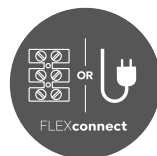

Seite/page 632





ELEMENT

Metall, Weiß matt oder Schwarz matt · metal, white mat or black mat ·
 metale, blanc mat ou noir mat · metaal, wit mat of mat zwart · metal, estera blanca o estera negra ·
 metallo, bianco opaco o nero opaco · metal, alb mat sau negru mat · metalli, valkoinen matto tai musta matto ·
 metal, biały mat lub czarny mat

 USB Anschluss mit Ladefunktion ·
 Recharging USB connection

 Getrennt schaltbar ·
 Separately switchable

 indirekte Beleuchtung ·
 indirect lighting

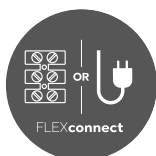

Seite/page 632



Wandleuchte · Wall lamp

↓ 20 x 16 cm, ↗ 14 cm
 incl. 1 x SMD-LED, 3 W
 220 lm, 3.000 K
 incl. 2 x SMD, 1,5 W
 2 x 150 lm, 3.000 K



222570231 | Weiß matt · white mat

222570232 | Schwarz matt · black mat



ANDREUS

Metall, weiß matt oder schwarz matt, Stoffschirm · metal, white mat or black mat, fabric shade ·
 metale, blanc mat ou noir mat, abat-jour tissu · metaal, wit mat of mat zwart, Stoffen kap ·
 metal, estera blanca o estera negra, Pantalla de tela · metallo, bianco opaco o nero opaco,
 paralume in tessuto · metal, alb mat sau negru mat, abajur textil · metalli, valkoinen matto
 tai musta matto, kangas varjostin · metal, biały mat lub czarny mat, Klosz z materiału



Empfohlen:
 recommended: Filament LED E14, 4 W
 400 lm, 2.700 K



989-479

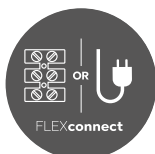

Seite/page 632

Wandleuchte · Wall lamp
 Ø 15 cm, ↑ 26,5 cm, ↗ 19,5 cm
 excl. 1 x E14, max. 40 W



207500179 | goldfarbig, Schwarz matt · gold, black mat
 207500189 | silberfarbig, Weiß mat · silver, white mat



WANDA

Metall, Kunststoff · metal, plastic ·
 metale, plastique · metaal, kunststof · metal, plástico ·
 metallo, plastica · metal, plastic · metalli, muovi · metal, plastik

Empfohlen:
 recommended: LED GU10, 3 W
 250 lm, 3.000 K



956-30

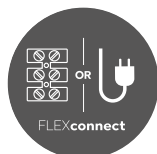

Seite/page 632



Wandleuchte · Wall lamp
 ↑ 23,5 cm, ↔ 8,5 cm, ↗ 22 cm
 excl. 1 x GU10, max. 35 W



202670107 | Nickel matt · nickel mat
 202670108 | Messing matt · brass mat
 202670131 | Weiß matt · white mat
 202670132 | Schwarz matt · black mat

BALDO

Metall, schwarz matt · metal, black mat ·
metale, noir mat · metaal, mat zwart · metal, estera negra ·
metallo, nero opaco · metal, negru mat · metalli, mattamusta ·
metal, czarny mat

Empfohlen:

recommended: Filament LED E27, 7 W
806 lm, 2.700 K



987-6810



386

Wandleuchte · Wall lamp

↔ 28 cm, ↓ 28,3 cm, ↗ max. 150 cm,
excl. 1 x E27, max. 40 W



200600132



LINE

Metall, schwarz matt · metal, black mat ·
metale, noir mat · metaal, mat zwart · metal, estera negra ·
metallo, nero opaco · metal, negru mat · metalli, mattamusta ·
metal, czarny mat

Empfohlen:

recommended: Filament LED E27, 7 W
806 lm, 3.000 K



988-600

Wandleuchte · Wall lamp

↔ 5,5 cm, ↓ 25 cm, ↗ max. 150 cm
excl. 1 x E27, max. 40 W



200200132



BOLDER

Metall, schwarz matt · metal, black mat ·
 metale, noir mat · metaal, mat zwart · metal, estera negra ·
 metallo, nero opaco · metal, negru mat · metalli, mattamusta ·
 metal, czarny mat

Empfohlen:
 recommended: Filament LED E27, 8 W
 806 lm, 2.700 K



985-6810

Wandleuchte · Wall lamp
 ↔ 35 cm, ↓ 29 cm, ↗ max. 150 cm
 excl. 1 x E27, max. 40 W



200300132



CUADRO

Altmessing oder Nickel matt · old brass or nickel mat ·
 laiton fumé ou nickel mat · oud brons of nikkel mat · bronze viejo o níquel mate ·
 ottone invecchiato o nichel opaco · bronz antic sau nichel mat ·
 antiikkimessinki tai harjattu teräs · patyna lub nikiel mat

Wandleuchte · Wall lamp
 ↔ 48 x 10,5 cm, ∇ 10 cm
 incl. 1 x SMD-LED, 8 W
 900 lm, 3.000 K



225210104 | Altmessing · old brass
 225210107 | Nickel matt · nickel mat





CURTIS

Altmessing, Nickel matt, Messing matt oder Schwarz matt · old brass, nickel mat, brass mat or black mat ·
 Laiton fumé, Nickel mat, Laiton mat ou Noir mat · Oud brons, Nikkel mat, Messing mat of Mat zwart ·
 Bronce viejo, Níquel mate, Bronce mate o Estera negra · Ottone invecchiato, Nichel opaco, Ottone satinato o Nero opaco ·
 Bronz antic, Nichel mat, Bronz mat sau Negru mat · Antiikkimessinki, Harjattu teräs, Mattamessinki tai mattamusta ·
 Patyna, Nikiel mat, Mosiądz mat lub Czarny mat

 Integrierter Dimmer ·
 Integrated dimmer



Wandleuchte · Wall lamp
 ↔ 18 cm, ↗ max. 35 cm
 incl. SMD-LED, 4 W
 380 lm, 3.000 K

 
279770104
279770107
279770108
279770132



Wandleuchte · Wall lamp

↔ 12 x 12 cm, 7 10 cm
incl. SMD-LED, 4,3 W
400 lm, 3.000 K



224810131
224810132
224810167

ARINO

Metall, Holz · metal, wood ·
metale, bois · metaal, hout · metal, madera ·
metallo, di legno · metal, lemn · metalli, puu · metal, drewno

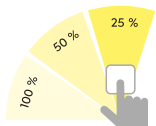

SWITCH DIMMER



31 | Weiß matt · white mat

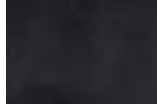

32 | Schwarz matt · black matt



67 | Nickel antik · nickel antique



Wandleuchte · Wall lamp

↔ 35,2 x 12 cm, 7 10 cm
incl. SMD-LED, 13,5 W
1.500 lm, 3.000 K



224819131
224819132
224819167







LACAPO

Metall · metal ·
metale · metaal · metallo · metal · metalli · metal

Wandleuchte · Wall lamp
↔ 10,5 cm, ↑ 6 cm, ↗ 15 cm
incl. SMD-LED, 4,3 W
430 lm, 3.000 K



223410131
223410132



31 | Weiß matt · white mat



32 | Schwarz matt · black mat



LOUIS

Metall · metal ·
metale · metaal · metallo · metal · metalli · metal · metal

Wandleuchte · Wall lamp
 ↑ 10 x 10 cm, ↗ 10 cm
 incl. 1 x OSRAM-LED, 4,3 W
 430 lm, 3.000 K



223310105
 223310131
 223310132



05 | Aluminium gebürstet · brushed aluminium



31 | Weiß matt · white mat

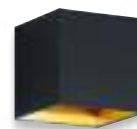

32 | Schwarz matt · black mat



MIGUEL

Metall, Weiß matt oder Schwarz matt · metal, white mat or black mat ·
 metale, blanc mat ou noir mat · metaal, wit mat of mat zwart · metal, estera blanca o estera negra ·
 metallo, bianco opaco o nero opaco · metal, alb mat sau negru mat · metalli, valkoinen matto tai musta matto · metal,
 biały mat lub czarny mat

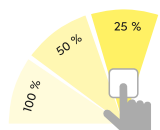

SWITCH DIMMER



31 | Weiß matt · white mat



32 | Schwarz matt · black mat

Wandleuchte · Wall lamp
 ↔ 20,5 x 16,5 cm, √ 8,3 cm
 incl. SMD-LED, 2 x 6 W
 2 x 600 lm, 3.000 K



224910231
224910232



MELVIN

Metall, Schwarz matt oder Nickel antik · metal, black mat or nickel antique ·
 metale, noir mat ou nickel antique · metaal, mat zwart of antiek nikkel ·
 metal, estera negra o níquel antiguo · metallo, nero opaco o nickel anticato ·
 metal, negru mat sau nichel antic · metalli, mattamusta tai antiikkiteräs ·
 metal, czarny mat lub aikiel antyczny

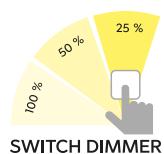

SWITCH DIMMER

32 | Schwarz matt · black mat



67 | Nickel antik · nickel antique



Wandleuchte · Wall lamp
 ↑ 8,5 x 11 cm, ↗ 10 cm
 incl. OSRAM-LED, 4,3 W
 430 lm, 3.000 K



223910132
 223910167

WALES

Nickel matt · nickel mat ·
nickel mat · nikkell mat · níquel mate ·
nichel opaco · nichel mat · harjattu teräs · nikiel mat



396

Wandleuchte · Wall lamp

↔ 9 cm, ↑ 9 cm, √ 5,8 cm
incl. 2 x SMD-LED, 3,1 W
2 x 310 lm, 3.000 K



225510207



CUBE

Beton · concrete ·
béton · beton · hormigón ·
cemento · beton · betoni · beton

Empfohlen:

recommended: LED GU10, 5 W
400 lm, 3.000 K



956-55



Wandleuchte · Wall lamp

↑ 15 x 10 cm, √ 9 cm
excl. 2 x GU10, max. 35 W



206600278





ZORRO

Metall, Weiß matt oder Schwarz matt · metal, white mat or black mat ·
 metale, blanc mat ou noir mat · metaal, wit mat of mat zwart · metal, estera blanca o estera negra ·
 metallo, bianco opaco o nero opaco · metal, alb mat sau negru mat · metalli, valkoinen matto tai musta matto ·
 metal, biały mat lub czarny mat



31 | Weiß matt · white mat

32 | Schwarz matt · black mat

Wandleuchte · Wall lamp
 ↔ 18 x 14,5 cm, ∇ 6,5 cm
 incl. 1 x SMD-LED, 6,5 W
 700 lm, 3.000 K

223210131
 223210132



DIP SWITCH

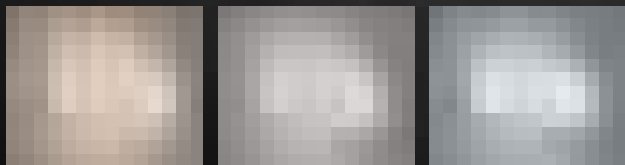

2.700 K

4.000 K

6.000 K

Lichtfarben direkt an der Leuchte einstellbar · Colours directly adjustable at the lamp · Les couleurs de la lumière peuvent être réglées directement sur le luminaire · Lichtkleuren direct instelbaar op de lamp · Tonalidades de luz ajustables directamente en la lámpara · Colori della luce regolabili direttamente sulla lampada · Culori ale luminii reglabile direct de la bec · Valon väri asetettävissa suoraan valaisimesta · Barwy światła można ustawić bezpośrednio na oprawie

CARLO

Metall, Nickel matt oder Weiß matt · metal, nickel mat or white mat ·
 metale, nickel mat ou blanc mat · metaal, nikkel mat of wit mat · metal, níquel mate o estera blanca · metallo, nichel opaco o bianco opaco ·
 metal, nichel mat sau alb mat · metalli, harjattu teräs tai mattavalkoinen · metal, nikiel mat lub biały mat

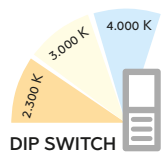

DIP SWITCH

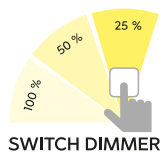

SWITCH DIMMER



Wandleuchte · Wall lamp
 ↔ 20 x 8 cm, ↗ 4,8 cm
 incl. SMD-LED, 8,5 W
 850 lm, 2.700 + 4.000 + 6.000 K



225271007
 225271031

Wandleuchte · Wall lamp
 ↔ 35 x 8 cm, ↗ 4,8 cm
 incl. SMD-LED, 14 W
 1.400 lm, 2.700 + 4.000 + 6.000 K



225271507
 225271531

Wandleuchte · Wall lamp
 ↔ 50 x 8 cm, ↗ 4,8 cm
 incl. SMD-LED, 18 W
 1.800 lm, 2.700 + 4.000 + 6.000 K



225272007
 225272031

07 | Nickel matt · nickel mat

31 | Weiß matt · white mat

CONCHA

rostfarbig, Weiß matt oder Anthrazit · rusty, white mat or anthracite ·
 rouille, blanc mat ou antracite · roestkleur, wit mat of antraciet · óxido, estera blanca o antracita ·
 ruggine, bianco opaco o antracite · ruginiu, alb mat sau antracit · rustiikki, mattavalkoinen tai antrasiitti ·
 miedz, biały mat lub antracyt

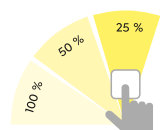

SWITCH DIMMER



24 | rostfarbig · rusty



31 | Weiß matt · white mat



42 | Anthrazit · anthracite



Wandleuchte · Wall lamp
 ↔ 28 x 8 cm, √ 4,5 cm
 incl. 2 x SMD-LED, 6 W
 2 x 600 lm, 3.000 K



225172924
 225172931
 225172942



Wandleuchte · Wall lamp
 ↔ 47 x 8 cm, √ 4,5 cm
 incl. 2 x SMD-LED, 9 W
 2 x 900 lm, 3.000 K



225174724
 225174731
 225174742

PLATON

Aluminium gebürstet, Acryl · brushed aluminium, acryl · aluminium balayé, acryl · geborsteld aluminium, acryl · aluminio pulido, acrílico · alluminio spazzolato, acrilico · aluminiu lucios, acrilic · harjattu alumiini, akryyli · aluminium szczotkowane, akryl



400

Wandleuchte · Wall lamp

↔ 13 x 18 cm, √ 9 cm
incl. 1 x SMD-LED, 4,3 W
430 lm, 3.000 K



274670105

Wandleuchte · Wall lamp

↔ 30 x 18 cm, √ 11 cm
incl. 2 x SMD-LED, 4,3 W
2 x 430 lm, 3.000 K



274670205



TRINITY

Aluminium gebürstet, Acryl · brushed aluminium, acryl · aluminium balayé, acryl · geborsteld aluminium, acryl · aluminio pulido, acrílico · alluminio spazzolato, acrilico · aluminiu lucios, acrilic · harjattu alumiini, akryyli · aluminium szczotkowane, akryl



Lichtfarbe einstellbar ·
Adjustable light color



3.000 K



4.000 K



5.500 K

Wandleuchte · Wall lamp

↑ 30 x 20 cm, √ 7 cm
incl. SMD-LED, 10 W
800 lm, 3.000+4.000+5.500 K



274813005





ADRIANO

Aluminium gebürstet oder Weiß · brushed aluminium or white ·
 aluminium balayé ou blanc · geborsteld aluminium of wit ·
 aluminio pulido o blanco · alluminio spazzolato o bianco ·
 aluminiu lucios sau alb · harjattu alumiini tai valkoinen ·
 aluminium szczotkowane lub biały



01 | Weiß · white



05 | Aluminium gebürstet · brushed aluminium

Wandleuchte · Wall lamp
 ↔ 30 x 6 cm, ∇ 8 cm
 incl. 2 x SMD-LED, 3,1 W
 2 x 310 lm, 3.000 K



220810201
 220810205

MARTA

Chrom, Glas · chrome, glass ·
chrome, verre · chrom, glas · cromo, vidrio ·
cromo, vetro · crom, sticla · kromi, lasi · chrom, szkło

Empfohlen:
recommended: LED E14, 3,5 W
320 lm, 3.000 K



989-40



402

Wandleuchte · Wall lamp
↔ 20 x 20 cm, ∅ 8,5 cm
excl. 1 x E14, max. 40 W



2523011-01



DIVO

Chrom, Glas · chrome, glass ·
chrome, verre · chrom, glas · cromo, vidrio ·
cromo, vetro · crom, sticla · kromi, lasi · chrom, szkło

Empfohlen:
recommended: LED E14, 3,5 W
320 lm, 3.000 K



989-40



Wandleuchte · Wall lamp
↔ 20 x 20 cm, ∅ 7,5 cm
excl. 1 x E14, max. 40 W



2522011-06

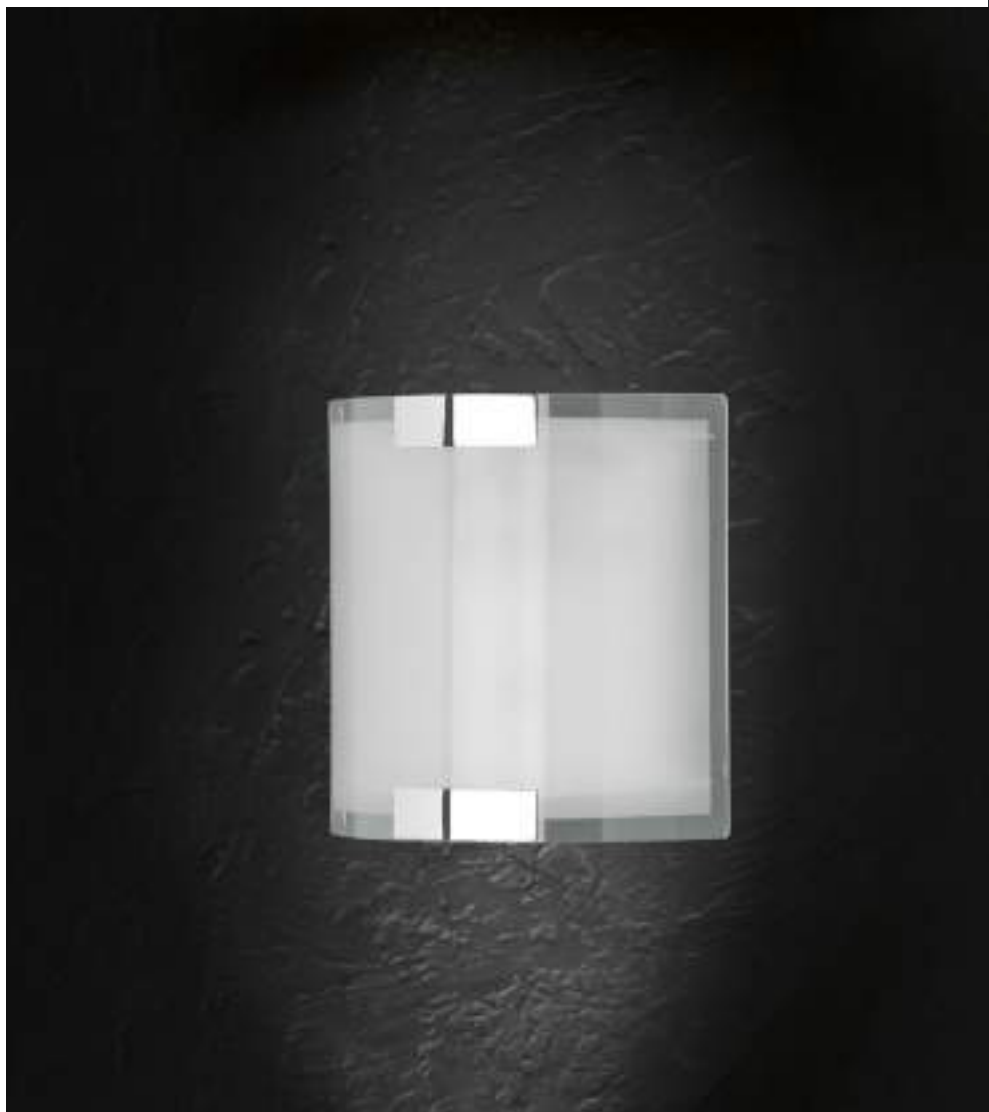



TOULON

Metall, Glas matt · metal, mat glass ·
 metale, verre mat · metaal, mat glas · metal, vidrio mate · metallo, vetro sabbiato ·
 metal, sticla mata · metalli, mattalasi · metal, szkło matowane

Empfohlen:
 recommended: LED E27, 7 W
 560 lm, 3.000 K



988-700



Wandleuchte · Wall lamp
 ↔ 13 cm, ↑ 44 cm, ↗ 13 cm
 excl. 1 x E27, max. 60 W



204700101

CONO

Nickel matt, Glas matt · nickel mat, mat glass ·
nickel mat, verre mat · nikkel mat, mat glas ·
níquel mate, vidrio mate · nichel opaco, vetro sabbiato ·
nichel mat, sticla mata · harjattu teräs, mattalasi ·
nikiel mat, szkło matowane

Empfohlen:
recommended: LED E14, 3,5 W
320 lm, 3.000 K



989-40

404

Wandleuchte · Wall lamp

↑ 35 cm, ↔ 10 cm, ∅ 15 cm
excl. 1 x E14, max. 60 W



2502211-07



CAMPO

rostfarbig, Scavo glas · rusty, scavo glass ·
rouille, verre scavo · roestkleur, scavo glas ·
óxido, vidrio scavo · ruggine, vetro scavo ·
ruginiu, sticla scavo · rustiikki, scavo-lasi ·
miedź, szkło scavo

Empfohlen:
recommended: Filament LED E14, 4 W
470 lm, 2.700 K



989-400

Wandleuchte · Wall lamp

↑ 44 cm, ↔ 12 cm, ∅ 16 cm
excl. 1 x E14, max. 40 W



200970124





PURA

Metall, Glas · metal, glass ·
 metale, verre · metaal, glas · metal, vidrio ·
 metallo, vetro · metal, sticla · metalli, lasi · metal, szkło

Empfohlen:
 recommended: Filament LED E27, 7 W
 806 lm, 2.700 K



987-6810

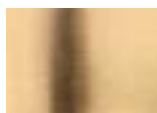

04 | Altmessing · old brass



07 | Nickel matt · nickel mat



Wandleuchte · Wall lamp
 ↓ 20 cm, ↔ 20 cm, ∅ 7,5 cm
 excl. 1 x E27, max. 40 W



212700104
212700107



Wandleuchte · Wall lamp
 ↓ 40 cm, ↔ 20 cm, ∅ 7,5 cm
 excl. 2 x E27, max. 40 W



212700204
212700207



ADRIAN

Glas alabasterfarbig · alabaster-coloured glass ·
verre couleur albâtre · albastkleurig glas ·
vidrio de color alabastro · vetro colore alabastro ·
sticla culoare alabastru · lasi alabasteri väri ·
szkło alabaster kolor



Deckenleuchte · Ceiling lamp
Ø 30 cm, ↑ 9 cm
excl. 1 x E27, max. 40 W



6105011-01



Deckenleuchte · Ceiling lamp
Ø 40 cm, ↑ 10 cm
excl. 2 x E27, max. 40 W



6105021-01



CHICO

Glas · glass ·
verre · glas · vidrio · vetro ·
sticla · lasi · szkło



Deckenleuchte · Ceiling lamp
Ø 30 cm, ↑ 9 cm
excl. 1 x E27, max. 60 W



6160011-00



LANA

Glas Weiß matt oder alabasterfarbig · glass white mat or alabaster coloured · verre blanc mat ou couleur albâtre · glas wit mat of albastkleurig · vidrio estera blanca o Color alabastro · vetro bianco opaco o color alabastro · sticla alb mat sau Colorat în alabastru · lasi mattavalkoinen tai alabasterin värinen · szkło biały mat lub kolor alabastrowy



Deckenleuchte · Ceiling lamp
Ø 25 cm, ↑ 9 cm
excl. 1 x E27, max. 40 W

Deckenleuchte · Ceiling lamp
Ø 25 cm, ↑ 9 cm
excl. 1 x E27, max. 40 W



6196011-01



6196011-07

PRIMO

Metall, Glas · metal, glass ·
metale, verre · metaal, glas · metal, vidrio · metallo, vetro ·
metal, sticla · metalli, lasi · metal, szkło



01 | Weiß · white



07 | Nickel matt · nickel mat

Deckenleuchte · Ceiling lamp
Ø 30 cm, ↑ 7,5 cm
excl. 1 x E27, max. 60 W



6101011-01
6101011-07



CARBONADO

Dekorglas · glas decorated ·
 verre décoré · decoratief glas · vidrio decorado ·
 vetro decorato · sticla decorativa · ornamenttilasi · szkło dekoracyjne



Wandleuchte · Wall lamp
 ↔ 20 x 22 cm, ↗ 10 cm
 excl. 1 x E14, max. 40 W



202400106



Deckenleuchte · Ceiling lamp
 Ø 25 cm, ↓ 9,5 cm
 excl. 1 x E27, max. 40 W



602400106



Deckenleuchte · Ceiling lamp
 Ø 30 cm, ↓ 10,5 cm
 excl. 2 x E27, max. 40 W



602400206

COLINA

Dekorglas · glas decorated ·
 verre décoré · decoratief glas · vidrio decorado ·
 vetro decorato · sticla decorativa · ornamenttilasi · szkło dekoracyjne



Wandleuchte · Wall lamp
 ↔ 17 cm, ↓ 23 cm, ↗ 8,5 cm
 excl. 1 x E27, max. 40 W



200400100



Deckenleuchte · Ceiling lamp
 ↔ 30 x 30 cm, ↓ 9 cm
 excl. 1 x E27, max. 40 W



600400100



Deckenleuchte · Ceiling lamp
 ↔ 40 x 40 cm, ↓ 9,5 cm
 excl. 2 x E27, max. 40 W



600400200

LILLY

Empfohlen:
recommended: Filament LED E27, 7 W
680 lm, 2.700 K



988-710



Deckenleuchte · Ceiling lamp

Ø 30 cm, ↓ 6 cm
excl. 1 x E27, max. 40 W



603300101

Überstreichbare Gipsleuchten ·
Gypsum lights that can be painted · Lampes en gypse à peindre ·
overschilderbare gipslampen · Lámparas de yeso que pueden
pintarse · Le lampade in gesso possono essere verniciate ·
Lámpi de ipsos, ce pot fi vopsite · Maalattava kipsivalaisin ·
Oświetlenie gipsowe, które można pomalować

ZAZOU

Empfohlen:
recommended: LED GU10, 5 W
400 lm, 3.000 K



955-50



Wandleuchte · Wall lamp
↓ 16,5 cm, ↔ 7,5 cm, ↗ 7 cm
excl. 2 x GU10, max. 10 W



201100201





ROMA

Überstreichbare Gipsleuchte · Gypsum lights that can be painted ·
 Lampes en gypse à peindre · overschilderbare gipslampen ·
 Lámparas de yeso que pueden pintarse · Le lampade in gesso possono essere verniciate ·
 Lämpit de ipsos, ce pot fi vopsite · Maalattava kipsivalaisin ·
 Oświetlenie gipsowe, które można pomalować

Empfohlen:
 recommended: LED E14, 4,9 W
 470 lm, 3.000 K



983-60



Wandleuchte · Wall lamp
 ↔ 24,5 x 9,5 cm, ↗ 12 cm
 excl. 1 x E14, max. 28 W



201000101

LAON

Nickel matt · nickel mat ·
nickel mat · nikkell mat · níquel mate ·
nichel opaco · nichel mat · harjattu teräs · nikiel mat

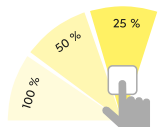

SWITCH DIMMER

Empfohlen:
recommended: LED GU10, 4,5 W
345 lm, 3.000 K



956-55

Steckerleuchte · Plug light

↑ 40 cm, ↔ 4,7 cm, ∠ max. 16 cm
incl. 1 x LED GU10, 5 W
400 lm, 3.000 K



899670107



LIGARA

Kunststoff · plastic ·
plastique · kunststof · plástico ·
plastica · plastic · muovi · plastik

Empfohlen:
recommended: LED E14, 3,5 W
320 lm, 3.000 K



983-40

Steckerleuchte · Plug light

↑ 28 cm, ↔ 6,9 cm, ∠ max. 20 cm
excl. 1 x E14, max. 40 W



8911211-07





LEVISTO

Glas alabasterfarbig · alabaster-coloured glass ·
verre couleur albâtre · albastkleurig glas ·
vidrio de color alabastro · vetro colore alabastro ·
sticla culoare alabastru · lasi alabasteri väri ·
szkło alabaster kolor

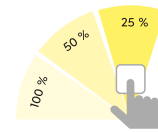

SWITCH DIMMER

Empfohlen:
recommended: LED E14, 4,9 W
470 lm, 3.000 K



983-66

Steckerleuchte · Plug light

↑ 40 cm, ↔ 4,7 cm, ↗ max. 22 cm
incl. 1 x LED E14, 6 W
470 lm, 3.000 K



891010107



FRED

Glas matt · mat glass ·
verre mat · mat glas · vidrio mate ·
vetro sabbaiato · sticla mata · mattalasi · szkło matowane

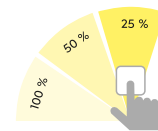

SWITCH DIMMER

Empfohlen:
recommended: LED G9, 2,3 W
200 lm, 3.000 K



929-220 Set 2

Steckerleuchte · Plug light

↑ 40 cm, ↔ 4,7 cm, ↗ max. 20 cm
incl. 1 x LED G9, 3 W
300 lm, 3.000 K



891770107

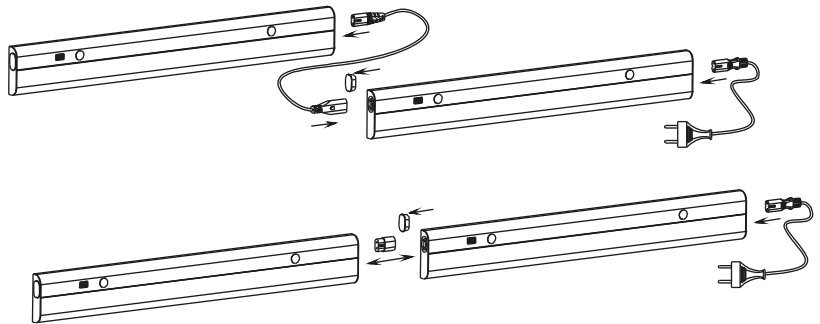
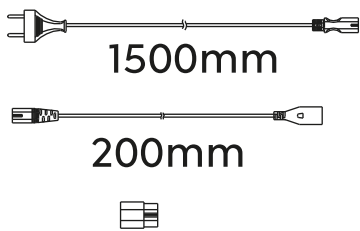



SIMEO

Kunststoff, Weiß · plastic, white ·
 plastique, blanc · kunststof, wit · plástico, blanco ·
 plastica, bianco · plastic, alb · muovi, valkoinen · plastik, biały



Gestensteuerung · Gesture control ·
 Contrôle gestuel · Gebaarbediening · Control gestual ·
 Controllo gestuale · Control prin gesturi/miscarea mainii ·
 Kädellä ohjattava liiketunnistin · Sterowana gestami



Unterbauleuchte · cabinet lighting
 ↔ 52,8 x 6,8 cm, ↓ 1,8 cm
 incl. SMD-LED, 10 W
 850 lm, 3.000 K



273271201



Unterbauleuchte · cabinet lighting
 ↔ 77 x 6,8 cm, ↓ 1,8 cm
 incl. SMD-LED, 15,5 W
 1.300 lm, 3.000 K



273271801



ARAGON

Kunststoff, Weiß oder titanfarbig · plastic, white or titan ·
 plastique, blanc ou titane · kunststof, wit of titaan · plástico, blanco o titán ·
 plastica, bianco o titano · plastic, alb sau titaniu · muovi, valkoinen tai titaani ·
 plastik, biały lub tytanowy



01 | Weiß · white



87 | titanfarbig · titanium-coloured



Unterbauleuchte · cabinet lighting
 ↔ 40 x 4 cm, ↓ 2 cm
 incl. 3 x SMD-LED, 1 W
 3 x 80 lm, 3.000 K



273170301
273170387



Unterbauleuchte · cabinet lighting
 ↔ 55 x 4 cm, ↓ 2 cm
 incl. 4 x SMD-LED, 1 W
 4 x 90 lm, 3.000 K



273170401
273170487



ALINO

Kunststoff, Weiß oder titanfarbig · plastic, white or titan ·
 plastique, blanc ou titane · kunststof, wit of titaan · plástico, blanco o titán ·
 plastica, bianco o titano · plastic, alb sau titaniu · muovi, valkoinen tai titaani ·
 plastik, biały lub tytanowy



01 | Weiß · white



87 | titanfarbig · titanium-coloured



Unterbauleuchte · cabinet lighting
 ↔ 34 x 7 cm, ↓ 2 cm
 incl. SMD-LED, 4 W
 350 lm, 3.000 K



272970401
272970487



Unterbauleuchte · cabinet lighting
 ↔ 55 x 7 cm, ↓ 2 cm
 incl. SMD-LED, 7 W
 600 lm, 3.000 K



272970701
272970787



ECCO

Nickel matt · nickel mat ·
 nickel mat · nikkell mat · níquel mate ·
 nichel opaco · nichel mat · harjattu teräs · nikiel mat

Unterbauleuchte · cabinet lighting

↔ 12,4 x 11,5 cm, ↑ 4,3 cm
 incl. 3 x SMD-LED, 3 W
 3 x 200 lm, 3.000 K



273370307 Set: 3 St./3 pc.





RAMON

Kunststoff · plastic ·
 plastique · kunststof · plástico ·
 plastica · plastic · muovi · plastik



Unterbauleuchte · cabinet lighting
 ↔ 28 x 2,5 cm, ↓ 4 cm
 incl. 1 x SMD-LED, 3,5 W
 400 lm, 3.000 K



273070401



Unterbauleuchte · cabinet lighting
 ↔ 51 x 2,5 cm, ↓ 4 cm
 incl. 1 x SMD-LED, 6,5 W
 700 lm, 3.000 K



273070701



Unterbauleuchte · cabinet lighting
 ↔ 84 x 2,5 cm, ↓ 4 cm
 incl. 1 x SMD-LED, 12 W
 1.400 lm, 3.000 K



273071301



Unterbauleuchte · cabinet lighting
 ↔ 114 x 2,5 cm, ↓ 4 cm
 incl. 1 x SMD-LED, 16,5 W
 1.850 lm, 3.000 K



273071801



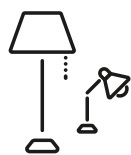

Tisch- & Stehleuchten

Table- & floor lamps

Lampes de table & lampadaires

Tafel- & vloerlampen

Sobremesas y lámparas de pie

Lampade da tavolo e piantane

Veioze si lampadare

Pöytä- & lattia

Stołowe i podłogowe

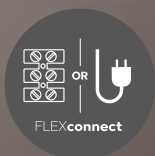

Seite/page 632



CASSIO

Metall, Stoff · metal, fabric ·
metale, tissu · metaal, textiel · metal, tela ·
metallo, tessuto · metal, textil · metalli, tekstiili · metal, tkanina



07 | Nickel matt · nickel mat

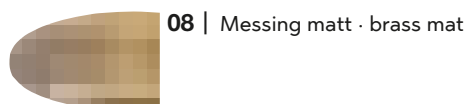

08 | Messing matt · brass mat

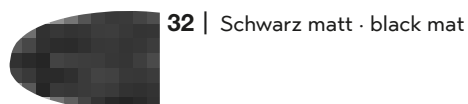

32 | Schwarz matt · black mat



Wandleuchte · Wall lamp
↑ 27,9 cm, Ø 23 cm, ∠ 25,9 cm
excl. 1 x E27, max. 40 W



214470107
214470108
214470132



Tischleuchte · Table lamp
↑ 48 cm, Ø 28 cm
excl. 1 x E27, max. 40 W



514400107
514400108
514400132



Stehleuchte · Floor lamp
↑ 153,3 cm, Ø 50 cm
excl. 1 x E27, max. 40 W



414400107
414400108
414400132



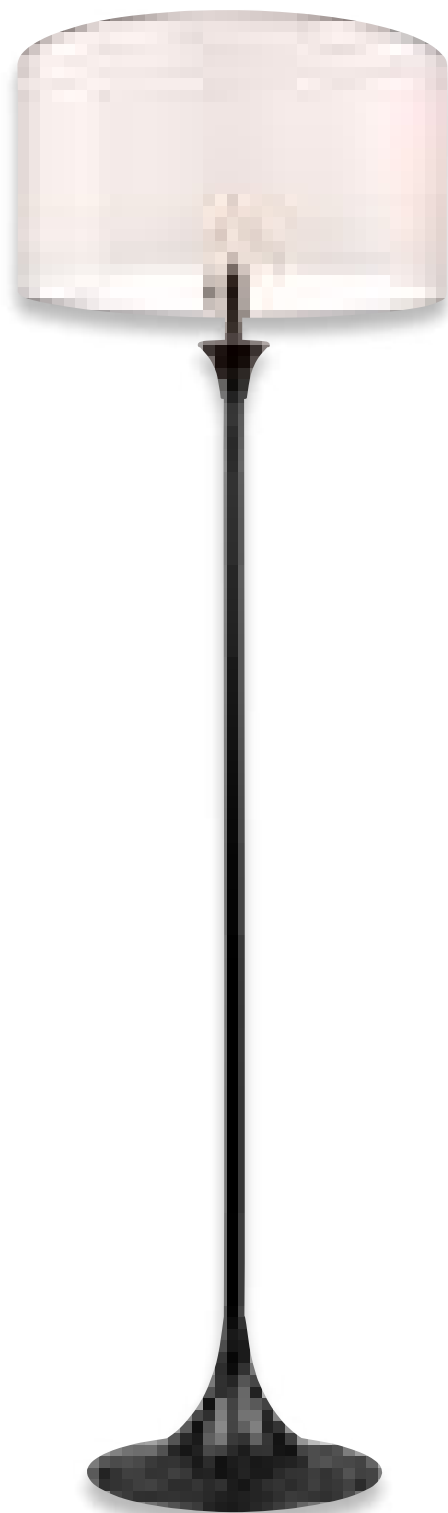
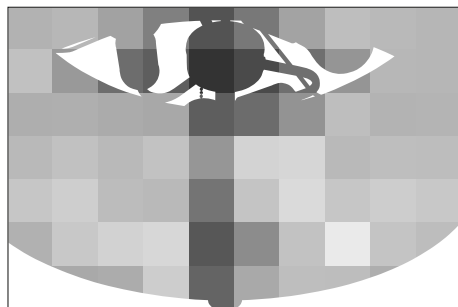

SABIA

Nickel matt oder Schwarz matt, Stoff · nickel mat or black mat, fabric ·
 nickel mat ou noir mat, tissu · nikkell mat of mat zwart, textiel ·
 níquel mate o estera negra, tela · nichel opaco o nero opaco, tessuto ·
 nichel mat sau negru mat, textil · harjattu teräs tai mattamusta, tekstiili ·
 nikiel mat lub czarny mat, tkanina



Tischleuchte · Table lamp
 ↓ 35 cm, Ø 20 cm
 excl. 1 x E27, max. 40 W



515790107
 515790132



Tischleuchte · Table lamp
 ↓ 62,5 cm, Ø 40 cm
 excl. 1 x E27, max. 40 W



515700107
 515700132



Stehleuchte · Floor lamp
 ↓ 155 cm, Ø 45,7 cm
 excl. 3 x E27, max. 40 W



415700307
 415700332





CANNES II

Chrom / Aluminium gebürstet, Acryl, Stoffschirm · chrome / brushed aluminium, acryl, fabric shade ·
 chrome / aluminium balayé, acryl, abat-jour tissu · chroom / geborsteld aluminium, acryl, Stoffen kap ·
 cromo / aluminio pulido, acrílico, Pantalla de tela · cromo / alluminio spazzolato, acrilico, paralume in tessuto ·
 crom / aluminiu lucios, acrilic, abajur textil · kromi / harjattu alumiini, akryyli, kangas varjostin ·
 chrom / aluminium szczotkowane, akryl, Klosz z materiału

Stehleuchte · Floor lamp

↑ 165 cm, Ø 38 cm
 incl. SMD-LED, 15,5 W
 1.370 lm, 3.000 K
 excl. 1 x E27, max. 60 W



422970206

1x ————— 2x ————— 3x



Getrennt schaltbar · Separately switchable · Interrupteurs séparés ·
 Gescheiden schakelbaar · Interruptores separados · Interruttori separati ·
 Intrerupatoare separate · Erikseen kytkettävissä · Oddzileny przełącznik





TANDORI

Nickel matt, Stoff · nickel mat, fabric ·
nickel mat, tissu · nikkel mat, textiel · níquel mate, tela ·
nichel opaco, tessuto · nichel mat, textil · harjattu teräs, tekstiili · nikiel mat, tkanina

1x ————— 2x ————— 3x



Getrennt schaltbar · Separately switchable
Interrupteurs séparés · Gescheiden schakelbaar · Interruptores separados ·
Interruttori separati · Intrerupatoare separate · Erikseen kytkettävissä ·
Oddzileny przełącznik



Tischleuchte · Table lamp
↑ 53 cm, Ø 25 cm
incl. 3 x SMD-LED, 1,8 W
3 x 150 lm, 3.000 K
excl. 1 x E27, max. 40 W



575410207



Stehleuchte · Floor lamp
↑ 156 cm, Ø 40 cm
incl. 3 x SMD-LED, 5 W
3 x 470 lm, 3.000 K
excl. 1 x E27, max. 40 W



475410207

1x

2x

3x



Getrennt schaltbar · Separately switchable
 Interrupteurs séparés · Gescheiden schakelbaar ·
 Interruptores separados · Interruttori separati ·
 Intreruptoare separate · Erikseen kytkettävissä ·
 Oddzielny przełącznik



NANDOR

Metall, Stoff · metal, fabric ·
 metale, tissu · metaal, textiel · metal, tela ·
 metallo, tessuto · metal, textil · metalli, tekstiili · metal, tkanina

07 | Nickel matt · nickel mat

79 | goldfarbig · gold



Tischleuchte · Table lamp
 † 62 cm, Ø 30 cm
 incl. 2 x SMD, 3 W
 2 x 300 lm, 3.000 K
 excl. 1 x E27, max. 40 W



575310307
 575310379



Stehleuchte · Floor lamp
 † 160,5 cm, Ø 40 cm
 incl. 2 x SMD, 7 W
 2 x 600 lm, 3.000 K
 excl. 1 x E27, max. 60 W



475310307
 475310379





CLAAS

Metall, Stoff · metal, fabric ·
metale, tissu · metaal, textiel · metal, tela ·
metallo, tessuto · metal, textil · metalli, tekstiili · metal, tkanina



USB Anschluss mit Ladefunktion ·
Recharging USB connection



07 | Nickel matt · nickel mat



32 | Schwarz matt · black mat



Stehleuchte · Floor lamp
↓ 160 cm, ↔ 40 cm, ↗ 40 cm
excl. 1 x E27, max. 60 W



400400107
400400132



PARIS II

Nickel matt oder Messing matt · nickel mat or brass mat ·
 nickel mat ou laiton mat · nikkell mat of messing mat ·
 níquel mate o bronz mate · nichel opaco o ottone satinato ·
 nichel mat sau bronz mat · harjattu teräs tai mattamessinki ·
 nikiel mat lub mosiądz mat



07 | Nickel matt · nickel mat

08 | Messing matt · brass mat



Tischleuchte · Table lamp
 ↓ 58 cm, Ø 35 cm
 excl. 1 x E27, max. 60 W



500200107
500200108



Stehleuchte · Floor lamp
 ↓ 160 cm, Ø 50 cm
 excl. 1 x E27, max. 60 W



400200107
400200108



HOTEL

Metall, Stoffschirm · metal, fabric shade ·
 metale, abat-jour tissu · metaal, Stoffen kap ·
 metal, Pantalla de tela · metallo, paralume in tessuto ·
 metal, abajur textil · metalli, kangas varjostin ·
 metal, Klosz z materiału

Stehleuchte · Floor lamp

↑ 170 cm, Ø 40 cm, √ 35 cm

excl. 1 x E27, max. 60 W

excl. 1 x E14, max. 18 W



403900201

403900208

403900211



01 | Nickel matt, Schirm Weiß ·
 nickel mat, shade white



08 | Messing matt, Schirm Creme-Weiß ·
 brass mat, shade cream white



11 | Nickel matt, Schirm Grau ·
 nickel mat, shade grey



MOTEL

Metall, Stoffschirm · metal, fabric shade ·
 metale, abat-jour tissu · metaal, Stoffen kap · metal, Pantalla de tela · metallo, paralume in tessuto ·
 metal, abajur textil · metalli, kangas varjostin · metal, Klosz z materiału



07 | Nickel matt, Schirm Schwarz/Weiß ·
 nickel mat, shade black/white



08 | Messing matt, Schirm Schwarz/goldfarbig ·
 brass mat, shade black/gold



Stehleuchte · Floor lamp
 ↓ 164 cm, Ø 40 cm, ∇ 54 cm
 excl. 1 x E27, max. 60 W
 excl. 1 x E14, max. 18 W



416900207
 416900208



CLARK

Metall, Schwarz matt, Stoffschirm mehrfarbig · metal, black mat, fabric shade multicolor ·
 metale, noir mat, abat-jour tissu multicolore · metaal, mat zwart, Stoffen kap multicolor ·
 metal, estera negra, Pantalla de tela multicolor · metallo, nero opaco, paralume in tessuto multicolore ·
 metal, negru mat, abajur textil multicolor · metalli, mattamusta, kangas varjostin monivärinen ·
 metal, czarny mat, Klosz z materiału multi-kolor



Stehleuchte · Floor lamp
 ↓ 198 cm, ↔ 35 cm, ↗ 170 cm
 excl. 3 x E27, max. 60 W



401700317



PONTE

Metall, Stoff · metal, fabric ·
 metale, tissu · metaal, textiel · metal, tela ·
 metallo, tessuto · metal, textil · metalli, tekstiili · metal, tkanina



31 | Weiß matt · white mat



32 | Schwarz matt · black mat



Stehleuchte · Floor lamp

↓ max. 168 cm, ↗ max. 125 cm, Ø 40 cm
 excl. 1 x E27, max. 60 W



401600131
 401600132



PEREZ

Chrom, Marmor, Stoff · chrome, marble, fabric ·
 chrome, marbre, tissu · chroom, marmer, textiel ·
 cromo, mármol, tela · cromo, marmo, tessuto ·
 crom, marmura, textil · kromi, marmori, tekstiili ·
 chrom, marmur, tkanina

Stehleuchte · Floor lamp
 † 170 - 200 cm, † 170 cm, Ø 50 cm
 excl. 3 x E27, max. 60 W



421100301
 421100302



01 | Weiß · white



02 | Schwarz · black





TRACY

Metall, Schwarz matt, Stoffschirm · metal, black mat, fabric shade ·
 metale, noir mat, abat-jour tissu · metaal, mat zwart, Stoffen kap · metal, estera negra, Pantalla de tela ·
 metallo, nero opaco, paralume in tessuto · metal, negru mat, abajur textil · metalli, mattamusta, kangas varjostin ·
 metal, czarny mat, Klosz z materiału

Stehleuchte · Floor lamp
 ↓ 175 cm, Ø 40 cm, ↗ max. 105 cm
 excl. 1 x E27, max. 60 W



462100132



SOLA

Chrom, Marmor, Acryl · chrome, marble, acryl ·
 chrome, marbre, acryl · chroom, marmer, acryl ·
 cromo, mármol, acrílico · cromo, marmo, acrilico ·
 crom, marmura, acrilic · kromi, marmori, akryyli ·
 chrom, marmur, akryl

Stehleuchte · Floor lamp
 ↑ 176 – 200 cm, ↗ 180 cm, Ø 40 cm
 excl. 1 x E27, max. 75 W



4200011-06



ARGENTINA

Messing matt, Marmor · brass mat, marble ·
 laiton mat, marbre · messing mat, marmor · bronze mate, mármol ·
 ottone satinato, marmo · bronz mat, marmura · mattamessinki, marmori ·
 mosiądz mat, marmur

Stehleuchte · Floor lamp
 † 200 cm, Ø 38 cm, ∠ 172,5 cm
 excl. 1 x E27, max. 75 W



411700108





BANGKOK

Metall, Schwarz matt, Marmor · metal, black mat, marble ·
 métal, noir mat, marbre · metaal, mat zwart, marmer · metal, estera negra, mármol ·
 metallo, nero opaco, marmo · metal, negru mat, marmura · metalli, mattamusta, marmori ·
 metal, czarny mat, marmur



Integrierter Dimmer ·
 Integrated dimmer

Stehleuchte · Floor lamp

↑ 180 cm, ↔ 22 x 23 cm, ↗ 127,5 cm
 incl. SMD-LED, 18 W
 2.200 lm, 3.000 K



426511832



SHANGHAI

Metall · metal ·
metale · metaal · metallo ·
metal · metalli · metal

 Integrierter Dimmer ·
Integrated dimmer

 **01** | Weiß · white

 **02** | Schwarz · black

 **87** | titanfarbig · titanium-coloured



Stehleuchte · Floor lamp
↑ 210 cm, ↔ 65 cm, ↗ 200 cm
incl. SMD-LED, 18 W
1.800 lm, 3.000 K



427511801
427511802
427511887



3.000 K

4.500 K

6.500 K

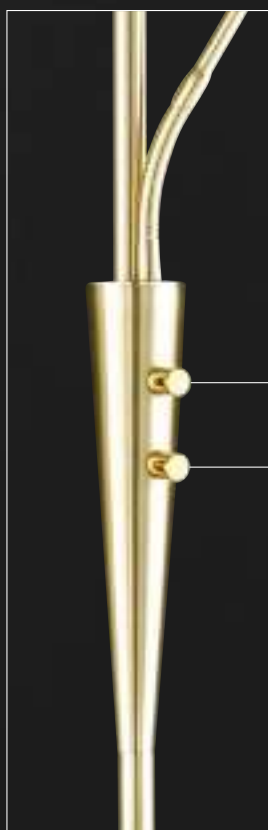

Dimmen und Lichtfarbe einstellen ·
 Dimming and adjusting light color ·
 Varier et choisir la couleur de la lumière ·
 Dimmen en lichtkleur instellen ·
 Atenuación y ajuste del color de la luz ·
 Variare e scegliere il colore della luce ·
 Variati lumina si ajustati culoarea luminii ·
 Himmennys ja värilämpötilan säätö vakiokytkimellä ·
 ściemniać i jasność ustawić



QUEBEC

Nickel matt oder Messing matt · nickel mat or brass mat ·
 nickel mat ou laiton mat · nikkell mat of messing mat ·
 níquel mate o bronze mate · nichel opaco o ottone satinato ·
 nichel mat sau bronz mat · harjattu teräs tai mattamessinki ·
 nikiel mat lub mosiądz mat



Lichtfarbe einstellbar ·
 Adjustable light color



Integrierter Dimmer ·
 Integrated dimmer



Memory Funktion ·
 Memory function



07 | Nickel matt · nickel mat



08 | Messing matt · brass mat

Stehleuchte · Floor lamp

↓ 180 cm, ↗ 50 cm
 incl. SMD-LED, 35 W
 4.200 lm, 3.000 + 4.500 + 6.500 K
 incl. SMD-LED, 5,5 W
 600 lm, 3.000 + 4.500 + 6.500 K



422710307

422710308



GRANBY

Metall · metal ·
metale · metaal · metal · metallo · metal · metalli · metal

 Lichtfarbe einstellbar ·
Adjustable light color

 Sensordimmer ·
Sensor dimmer

 Memory Funktion ·
Memory function

 **04** | Altmessing · old brass

 **07** | Nickel matt · nickel mat

 **08** | Messing matt · brass mat

 **32** | Schwarz matt · black mat

Stehleuchte · Floor lamp
↓ 180 cm, ↔ 29,5 cm, ↗ 46 cm
incl. SMD-LED, 29 W
3.400 lm, 2.700 + 3.200 + 4.000 K
incl. SMD-LED, 6,5 W
650 lm, 2.700 + 3.200 + 4.000 K



424310204
424310207
424310208
424310232





BRANTFORD

Metall · metal ·
metale · metaal · metal · metallo · metal · metalli · metal

 Lichtfarbe einstellbar ·
Adjustable light color

 Sensordimmer ·
Sensor dimmer

 Memory Funktion ·
Memory function



 **04** | Altmessing · old brass

 **07** | Nickel matt · nickel mat

 **08** | Messing matt · brass mat

 **32** | Schwarz matt · black mat

Stehleuchte · Floor lamp
 ↓ 180 cm, ↔ 30 cm, ↗ 41,6 cm
 incl. SMD-LED, 30 W
 3.500 lm, 2.700 + 3.200 + 4.000 K
 incl. SMD-LED, 6,5 W
 650 lm, 2.700 + 3.200 + 4.000 K



425610204
 425610207
 425610208
 425610232



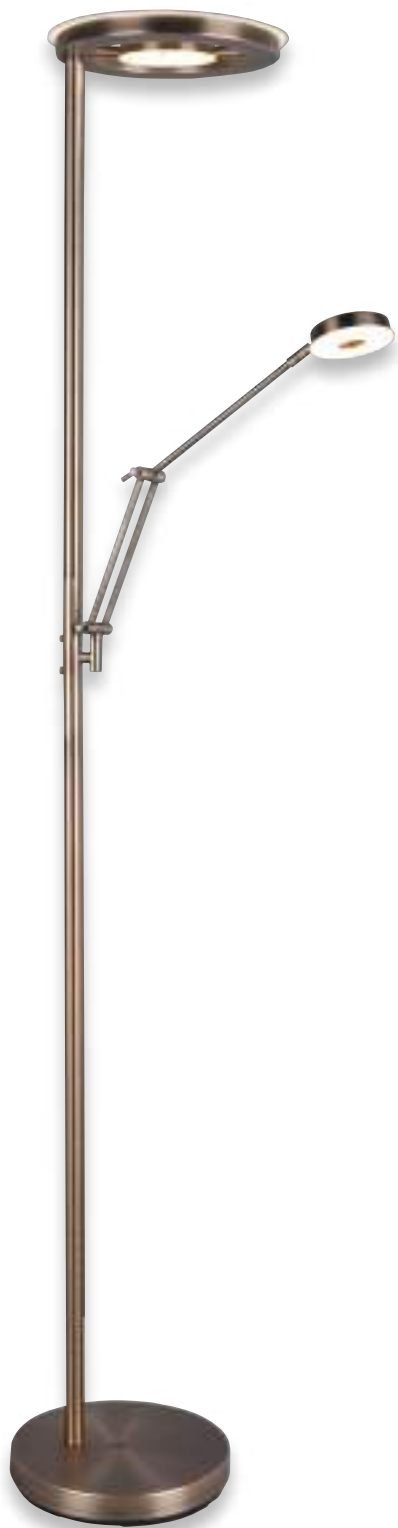

BARRIE

Metall · metal ·
metale · metaal · metal · metallo ·
metal · metalli · metal



Lichtfarbe einstellbar ·
Adjustable light color



Sensordimmer ·
Sensor dimmer



Memory Funktion ·
Memory function



04 | Altmessing · old brass



07 | Nickel matt · nickel mat



32 | Schwarz matt · black mat

Stehleuchte · Floor lamp
 † 181 cm, Ø 30 cm, ʘ 70 cm
 incl. SMD-LED, 32 W, 3.700 lm
 incl. SMD-LED, 6 W, 700 lm
 2.700 + 4.000 K



424210304
 424210307
 424210332





ARANGO

Nickel matt oder Altmessing · nickel mat or old brass ·
nickel mat ou laiton fumé · nikkell mat of oud brons ·
níquel mate o bronce viejo · nichel opaco o ottone invecchiato ·
nichel mat sau bronz antic · harjattu teräs tai antiikkimessinki ·
nikiel mat lub patyna



Integrierter Dimmer ·
Integrated dimmer

Stehleuchte · Floor lamp

↑ 180 cm, Ø 31 cm
incl. 1 x SMD-LED, 18 W
2.000 lm, 3.000 K



429110104 | Altmessing · old brass
429110107 | Nickel matt · nickel mat



ARIZONA

Nickel matt oder Messing matt · nickel mat or brass mat ·
nickel mat ou laiton mat · nikkell mat of messing mat ·
níquel mate o bronce mate · nichel opaco o ottone satinato ·
nichel mat sau bronz mat · harjattu teräs tai mattamessinki ·
nikiel mat lub mosiądz mat



Sensordimmer ·
Sensor dimmer

Stehleuchte · Floor lamp

↑ 180 cm, Ø 25,5 cm, ∠ 40 cm
incl. SMD-LED, 20 W, 2.000 lm, 3.000 K
incl. 1 x SMD-LED, 5 W, 500 lm, 3.000 K



426410207 | Nickel matt · nickel mat
426410208 | Messing matt · brass mat



SANTO II

Metall, Glas alabasterfarbig · metal, alabaster-coloured glass ·
 metale, verre couleur albâtre · metaal, albastkleurig glas · metal, vidrio de color alabastro ·
 metallo, vetro colore alabastro · metal, sticla culoare alabastru · metalli, lasi alabasteri väri ·
 metal, szkło alabaster kolor



Integrierter Dimmer ·
 Integrated dimmer



07 | Nickel matt · nickel mat



28 | rostfarbig antik · antique rust



Stehleuchte · Floor lamp

↑ 180 cm, Ø 25,5 cm, ∇ 40 cm

incl. 4 x SMD-LED, 4,8 W, 4 x 450 lm, 3.000 K

incl. 1 x SMD-LED, 4,8 W, 450 lm, 3.000 K



421910207

421910228



CHRIS

Chrom, Acryl mit Kristalleffekt · chrome, broken glass optic ·
 chrome, optique verre pilé · chroom, gebroken glas optiek ·
 cromo, efecto cristal roto · cromo, effetto ottico vetro rotto ·
 crom, aspect de sticla sparta · kromi, lasi efekti optiikka ·
 chrom, optyczne rozbite szkło

 Integrierter Dimmer ·
 Integrated dimmer



Deckenleuchte · Ceiling lamp

↑ 180 cm, ↗ 52 cm

incl. 1 x SMD-LED, 18 W, 2.000 lm, 3.000 K

incl. 1 x SMD-LED, 3,8 W, 350 lm, 3.000 K



478310206



Stufenlos dimmbar, Lichtfarbe stufenlos einstellbar ·
infinitely dimmable, light color infinitely variable ·
infiniment dimmable, couleur de lumière infiniment
variable · traploos dimbaar, lichtkleur traploos
instelbaar · sin etapas regulable, color de luz
infinitamente variable · infinitamente dimmerabile,
colore della luce infinitamente variabile ·
variator de lumina fara trepte, cu intrerupator
standard de lumina · portaaton himmennys,
valon väri portaattomasti · bezstopniowe
ściemnianie, jasny kolor bezstopniowo

453

SPLIT

Nickel matt · nickel mat ·
nickel mat · nikkel mat · níquel mate ·
nichel opaco · nichel mat · harjattu teräs · nikiel mat



Lichtfarbe stufenlos einstellbar ·
Light color infinitely variable



Integrierter Dimmer ·
Integrated dimmer



Memory Funktion ·
Memory function

Stehleuchte · Floor lamp
↓ 181 cm, ↔ 33 cm, √ 43 cm
incl. SMD-LED, 20 W
2.000 lm, 3.000 - 6.500 K
incl. 1 x SMD-LED, 3,5 W
400 lm, 3.000 - 6.500 K





424910207



PAVIA

Metall, Altmessing, Schwarz matt oder Weiß matt · metal, old brass, black mat or white mat ·
 métal, laiton fumé, noir mat ou blanc mat · metaal, oud brons, mat zwart of wit mat ·
 metal, bronce viejo, estera negra o estera blanca · metallo, ottone invecchiato, nero opaco
 o bianco opaco · metal, bronz antic, negru mat sau alb mat · metalli, antiikkimessinki,
 mattamusta tai mattavalkoinen · metal, patyna, czarny mat lub biały mat

 Lichtfarbe einstellbar ·
 Adjustable light color

 Sensordimmer ·
 Sensor dimmer

 Integrierter Dimmer ·
 Integrated dimmer

 **04** | Altmessing · old brass

 **31** | Weiß matt · white mat

 **32** | Schwarz matt · black mat



Tischleuchte · Table lamp
 ↑ 38,5 cm, ↔ 14 cm, ↗ 43 cm
 incl. SMD-LED, 12 W
 1.400 lm, 2.300 + 3.000 + 4.000 K



570310104
570310131
570310132

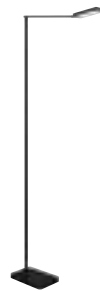

Stehleuchte · Floor lamp
 ↑ 130,5 cm, ↔ 16 cm, ↗ 48 cm
 incl. SMD-LED, 12 W
 1.400 lm, 2.300 + 3.000 + 4.000 K



470310104
470310131
470310132





Tischleuchte · Table lamp
 ↓ 57 cm, ↔ 19 cm, ↗ 46 cm
 incl. SMD-LED, 12 W
 1.400 lm, 2.300 + 3.000 + 4.000 K



523310107
523310108
523310132



Stehleuchte · Floor lamp
 ↓ 145 cm, ↔ 25 cm, ↗ 50 cm
 incl. SMD-LED, 12 W
 1.400 lm, 2.300 + 3.000 + 4.000 K



423310107
423310108
423310132



MONZA

Metall · metal ·
metale · metaal · metal ·
metallo · metal · metalli · metal



Lichtfarbe einstellbar ·
Adjustable light color



Sensordimmer ·
Sensor dimmer



Memory Funktion ·
Memory function



07 | Nickel matt · nickel mat



08 | Messing matt · brass mat



32 | Schwarz matt · black mat

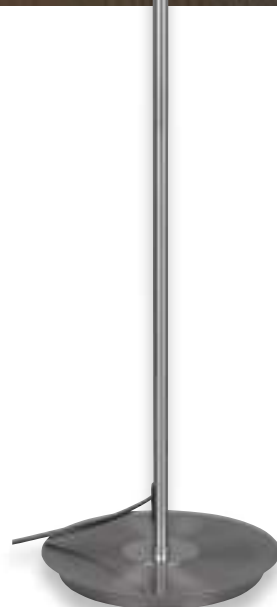



BERGAMO

Nickel matt oder Messing matt · nickel mat or brass mat ·
 nickel mat ou laiton mat · nikkell mat of messing mat ·
 níquel mate o bronce mate · nichel opaco o ottone satinato ·
 nichel mat sau bronz mat · harjattu teräs tai mattamessinki ·
 nikiel mat lub mosiądz mat



07 | Nickel matt · nickel mat



08 | Messing matt · brass mat



Tischleuchte · Table lamp
 ↓ 50 cm, ↗ 40 cm
 incl. 1 x SMD-LED, 12 W
 1.100 lm, 3.000 K



520910107
520910108



Stehleuchte · Floor lamp
 ↓ 135 cm, ↗ 50 cm
 incl. 1 x SMD-LED, 12 W
 1.100 lm, 3.000 K



420910107
420910108



VERONA

Nickel matt · nickel mat ·
nickel mat · nikkell mat · níquel mate · nichel opaco ·
nichel mat · harjattu teräs · nikiel mat



Sensordimmer · Sensor dimmer
Variateur tactile · Touchdimmer ·
Regulador con sensor · Touchdimmer ·
Variator cu senzor · Kosketushimmennin ·
Czujnik ściemniania ·



Stehleuchte · Floor lamp
↑ 126 cm, ↗ 60 cm
incl. 1 x SMD-LED, 12 W
1.100 lm, 3.000 K



420810107

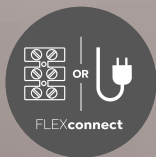

Seite/page 632

KAZAN

Nickel matt oder Schwarz matt · nickel mat or black mat ·
 nickel mat ou noir mat · nikkell mat of mat zwart ·
 níquel mate o estera negra · nichel opaco o nero opaco ·
 nichel mat sau negru mat · harjattu teräs tai musta matto ·
 nikiel mat lub czarny mat



07 | Nickel matt · nickel mat



32 | Schwarz matt · black mat



Wandleuchte · Wall lamp
 Ø 14 cm, ↗ max. 55 cm
 incl. 1 x SMD, 8 W
 800 lm, 3.000 K



274770107
 274770132



Stehleuchte · Floor lamp
 ↑ 121,5 cm, ↔ 24 cm, ↗ max. 61,5 cm
 incl. 1 x SMD, 8 W
 800 lm, 3.000 K



474790107
 474790132





CALCIO

Nickel matt oder Messing matt · nickel mat or brass mat ·
 nickel mat ou laiton mat · nikkell mat of messing mat · níquel mate o bronze mate ·
 nichel opaco o ottone satinato · nichel mat sau bronz mat · harjattu teräs tai mattamessinki ·
 nikiel mat lub mosiądz mat

 Integrierter Dimmer ·
 Integrated dimmer

 **07** | Nickel matt · nickel mat

 **08** | Messing matt · brass mat



Tischleuchte · Table lamp
 ↑ 43 cm, ↗ 50 cm
 incl. 1 x SMD-LED, 6 W
 560 lm, 3.000 K



572410107
 572410108



Stehleuchte · Floor lamp
 ↑ 120 - 140 cm, ↗ max. 71 cm
 incl. 1 x SMD-LED, 10 W
 1.050 lm, 3.000 K



422410107
 422410108





Tischleuchte · Table lamp
↑ 45 cm, ↔ 12 cm, ↗ 25 cm
excl. 1 x GU10, max. 5 W



- 512400107
- 512400108
- 512400131
- 512400132



Stehleuchte · Floor lamp
↑ 151 cm, ↔ 23 cm, ↗ 39 cm
excl. 1 x GU10, max. 5 W



- 412400107
- 412400108
- 412400131
- 412400132





MARLEY

Metall · metal ·
metale · metaal · metal · metallo · metal · metalli · metal

Empfohlen:
recommended: LED GU10, 4,5 W
345 lm, 3.000 K



956-55

07 | Nickel matt · nickel mat

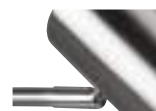

08 | Messing matt / Schwarz matt
brass matt / black mat



31 | Weiß matt · white mat



32 | Schwarz matt · black mat





NARCOS

Nickel matt, Weiß matt oder Schwarz matt · nickel mat, white mat or black mat ·
 nickel mat, blanc mat ou noir mat · nikkell mat, wit mat of mat zwart · níquel mate, estera blanca o estera negra ·
 nichel opaco, bianco opaco o nero opaco · nichel mat, alb mat sau negru mat · harjattu teräs, valkoinen matto tai musta matto ·
 nikiel mat, biały mat lub czarny mat

 4 fach TOUCH ·
4 level Touch function

Stehleuchte · Floor lamp
 ↑ 154 cm, ↔ 28 cm
 incl. 3 x SMD-LED, 4,7 W
 3 x 470 lm, 3.000 K



473190307
 473190331
 473190332

 **07** | Nickel matt · nickel mat

 **31** | Weiß matt · white mat

 **32** | Schwarz matt · black mat





FILIGRAN

Nickel matt oder Schwarz matt · nickel mat or black mat ·
 nickel mat ou noir mat · nikkell mat of mat zwart · níquel mate o estera negra ·
 nichel opaco o nero opaco · nichel mat sau negru mat · harjattu teräs tai mattamusta · nikiel mat lub czarny mat



Sensordimmer ·
 Sensor dimmer

Stehleuchte · Floor lamp
 † 162 cm, † 52 cm
 incl. 1 x SMD-LED, 6 W
 560 lm, 3.000 K



420490107
 420490132



07 | Nickel matt · nickel mat

32 | Schwarz matt · black mat





DAKOTA

Metall, schwarz matt · metal, black mat ·
 metale, noir mat · metaal, mat zwart · metal, estera negra ·
 metallo, nero opaco · metal, negru mat · metalli, mattamusta · metal, czarny mat

Empfohlen:
 recommended: LED G9, 3 W
 300 lm, 3.000 K



929-230

Stehleuchte · Floor lamp
 ↓ 155 cm, ↔ 23 cm
 excl. 3 x G9, max. 28 W



404600332



EDWARD

Metall, Schwarz matt · metal, black mat ·
 metale, noir mat · metaal, mat zwart ·
 metal, estera negra · metallo, nero opaco ·
 metal, negru mat · metalli, mattamusta ·
 metal, czarny mat

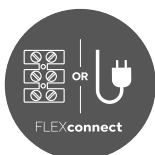

Seite/page 632



Wandleuchte · Wall lamp
 ↓ 25 cm, ↔ 12 cm, ↗ 50 cm
 excl. 1 x E14, max. 40 W



208870132



Stehleuchte · Floor lamp
 ↓ 160 cm, ↔ 38 cm
 excl. 3 x E14, max. 40 W



408800332



FREDDY

Nickel matt, Glas matt · nickel mat, mat glass ·
 nickel mat, verre mat · nikkel mat, mat glas · níquel mate, vidrio mate ·
 nichel opaco, vetro sabbiato · nichel mat, sticla mata ·
 harjattu teräs, mattalasi · nikiel mat, szkło matowane



incl.
 LED E14, 3,5 W
 320 lm, 3.000 K

983-40



Stehleuchte · Floor lamp
 ↑ 125 cm, ↗ 55 cm
 incl. 2 x LED E14, 4 W
 2 x 320 lm, 3.000 K



424810207



Stehleuchte · Floor lamp
 ↑ 150 cm, ↗ 55 cm
 incl. 1 x LED E14, 4 W
 320 lm, 3.000 K



424810107



ICARO

Metall, Glas matt · metal, mat glass ·
 metale, verre mat · metaal, mat glas · metal, vidrio mate ·
 metallo, vetro sabbiato · metal, sticla mata · metalli, mattalasi · metal, szklo matowane

Stehleuchte · Floor lamp
 ↑ 165 cm, ↗ 54 cm
 excl. 1 x E27, max. 60 W



4035011-04
 4035011-07
 4035011-08



04 | Altmessing · old brass



07 | Nickel matt · nickel mat



08 | Messing matt · brass mat



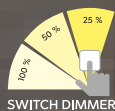

SWITCH DIMMER

TEXEL

Metall Schwarz matt/goldfarbig · metal black mat/gold ·
 metale noir mat/or · metaal mat zwart/goud · metal estera negra/oro ·
 metallo nero opaco/oro · metal negru mat/aur · metalli musta matto/kultaa ·
 metal czarny mat/złota



Tischleuchte · Table lamp
 ↑ 47,5 cm, Ø 16 cm
 incl. 1 x SMD-LED, 6,8 W
 650 lm, 3.000 K



574410179

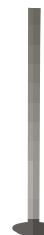

Stehleuchte · Floor lamp
 ↑ 142,5 cm, Ø 25 cm
 incl. 1 x SMD-LED, 15 W
 1.450 lm, 3.000 K



474410179



LIÈGE

Holz, Metall, Schwarz matt/goldfarbig · wood, metal, black mat/gold ·
 bois, metale, noir mat/or · hout, metaal, mat zwart/goud ·
 madera, metal, estera negra/oro · di legno, metallo, nero opaco/oro ·
 lemn, metal, negru mat/aur · puu, metalli, mattamusta/kultaa ·
 drewno, metal, czarny mat/złota

Empfohlen:
 recommended: Filament LED E27, 7 W
 806 lm, 2.700 K



987-6810



Stehleuchte · Floor lamp
 ↓ 120 - 160 cm, ↔ 80 cm
 excl. 1 x E27, max. 60 W



407800132



LANCE

Metall, Chrom oder Schwarz, Glas rauchfarbig oder mehrfarbig ·
 metal, chrome or black, glass smoke or multicolor ·
 metals, chrome ou noir, verre fumé ou multicolore ·
 metaal, chrom of zwart, glas rookkleur of multicolor ·
 metal, cromo o negro, vidrio humo o multicolor ·
 metallo, cromo o nero, vetro fume' o multicolore ·
 metal, crom sau negru, sticla fumuriu sau multicolor ·
 metalli, kromi tai musta, lasi savu tai monivärinen ·
 metal, chrom lub czarny, szkło przydymiony lub multi-kolor

Stehleuchte · Floor lamp

↑ 156 cm, Ø 60 cm

excl. 3 x E14, max. 28 W



403400317 | mehrfarbig · multicolor

403400354 | rauchfarbig · smoke



Chrom, Glas rauchfarbig ·
chrome, glass smoke



Schwarz matt, Glas multicolor ·
black mat, glass multicolor



JOOST II

Nickel matt, Glas matt · nickel mat, mat glass ·
nickel mat, verre mat · nikkel mat, mat glas ·
níquel mate, vidrio mate · nichel opaco, vetro sabbiato ·
nichel mat, sticla mata · harjattu teräs, mattalasi ·
nikiel mat, szkło matowane

 On/Off Touch Funktion ·
On/Off Touch function

Empfohlen:
recommended: LED E27, 4,9 W
470 lm, 3.000 K



987-60

476

Tischleuchte · Table lamp

‡ 39 cm, Ø 19 cm
excl. 1 x E27, max. 60 W



592300107



HENK II

Metall, Glas alabasterfarbig · metal, alabaster-coloured glass ·
metale, verre couleur albâtre · metaal, albastkleurig glas ·
metal, vidrio de color alabastro · metallo, vetro colore alabastro ·
metal, sticla culoare alabastru · metalli, lasi alabasteri väri ·
metal, szkło alabaster kolor

 On/Off Touch Funktion ·
On/Off Touch function

 **07** | Nickel matt · nickel mat

 **08** | Messing matt · brass mat

Tischleuchte · Table lamp

‡ 37 cm, Ø 26 cm
excl. 1 x E14, max. 40 W



592600107
592600108



Empfohlen:
recommended: LED E14, 3,5 W
320 lm, 3.000 K



983-43



32

BERLIN

Metall, Glas matt · metal, mat glass ·
 metale, verre mat · metaal, mat glas ·
 metal, vidrio mate · metallo, vetro sabbiato ·
 metal, sticla mata · metalli, matalasi ·
 metal, szkło matowane · metal, mat cam



4 fach TOUCH ·
 4 level Touch function



07



79

Tischleuchte · Table lamp

↓ 39 cm, Ø 19,5 cm
 incl. 1 x SMD-LED, 4 W
 350 lm, 3.000 K



527590107 | Nickel matt · nickel mat
 527590132 | Schwarz matt · black mat
 527590179 | goldfarbig · gold

CRISTO

Chrom oder Nickel matt, Glas · chrome or nickel mat, glass · chrome ou nickel mat, verre · chrom of nikkell mat, glas · cromo o níquel mate, vidrio · cromo o nichel opaco, vetro · crom sau nichel mat, sticla · kromi tai harjattu teräs, lasi · chrom lub nikiel mat, szkło



4 fach TOUCH ·
4 level Touch function



00 | Chrome, Transparent ·
chrome, transparent



07 | Nickel matt, Glas weiß ·
nickel mat, glass white



478

Tischleuchte · Table lamp

↑ 14,5 cm, Ø 11 cm
incl. 1 x SMD-LED, 4,3 W
430 lm, 3.000 K



529690100
529690107

DONNA

Metall, Glas alabasterfarbig · metal, alabaster-coloured glass · metale, verre couleur albâtre · metaal, albastkleurig glas · metal, vidrio de color alabastro · metallo, vetro colore alabastro · metal, sticla culoare alabastru · metalli, lasi alabasteri väri · metal, szkło alabaster kolor



4 fach TOUCH ·
4 level Touch function



07 | Nickel matt · nickel mat



08 | Messing matt · brass mat

Tischleuchte · Table lamp

↑ 30 cm, Ø 22,5 cm
incl. 1 x SMD-LED, 4,5 W
450 lm, 3.000 K



525790107
525790108





VENTURA

Metall, Glas matt · metal, mat glass ·
 metale, verre mat · metaal, mat glas · metal, vidrio mate ·
 metallo, vetro sabbaiato · metal, sticla mata · metalli, mattalasi ·
 metal, szkło matowane



4 fach TOUCH ·
 4 level Touch function



03 | Messing poliert · polished brass



07 | Nickel matt · nickel mat



Tischleuchte · Table lamp
 ↑ 29 cm, Ø 15,5 cm
 incl. 1 x SMD-LED, 4 W
 350 lm, 3.000 K



529990103
 529990107

LUIS II

Metall, Glas alabasterfarbig · metal, alabaster-coloured glass ·
metale, verre couleur albâtre · metaal, albastkleurig glas ·
metal, vidrio de color alabastro · metallo, vetro colore alabastro ·
metal, sticla culoare alabastru · metalli, lasi alabasteri väri ·
metal, szkło alabaster kolor



On/Off Touch Funktion ·
On/Off Touch function



06 | Chrom · chrome



07 | Nickel matt · nickel mat



08 | Messing matt · brass mat

480

Tischleuchte · Table lamp

↑ 32 cm, Ø 12
excl. 1 x E14, max. 40 W



595700106
595700107
595700108

Empfohlen:
recommended: LED E14, 3,5 W
320 lm, 3.000 K



983-40



EMERALD

Metall, Glas matt · metal, mat glass ·
metale, verre mat · metaal, mat glas · metal, vidrio mate ·
metallo, vetro sabbiato · metal, sticla mata · metalli, mattalasi ·
metal, szkło matowane



4 fach TOUCH ·
4 level Touch function



06 | Chrom · chrome



07 | Nickel matt · nickel mat

Tischleuchte · Table lamp

↑ 29 cm, Ø 15 cm
incl. 1 x SMD-LED, 4,5 W
450 lm, 3.000 K



525490106
525490107





FYNN II

Metall, Glas alabasterfarbig · metal, alabaster-coloured glass ·
 metale, verre couleur albâtre · metaal, albastkleurig glas · metal, vidrio de color alabastro ·
 metallo, vetro colore alabastro · metal, sticla culoare alabastru · metalli, lasi alabasteri väri ·
 metal, szkło alabaster kolor

 On/Off Touch Funktion ·
 On/Off Touch function

Empfohlen:
 recommended: LED E14, 3,5 W
 320 lm, 3.000 K



983-40

Tischleuchte · Table lamp
 ↑ 21 cm, Ø 15 cm
 excl. 1 x E14, max. 40 W



599100106 | Chrom · chrome
 599100107 | Nickel matt · nickel mat
 599100108 | Messing matt · brass mat
 599100118 | Orange · orange
 599100124 | rostfarbig · rusty

ARY II

Metall, Glas matt · metal, mat glass ·
metale, verre mat · metaal, mat glas · metal, vidrio mate ·
metallo, vetro sabbiato · metal, sticla mata · metalli, mattalasi ·
metal, szkło matowane



On/Off Touch Funktion ·
On/Off Touch function



07 | Nickel matt · nickel mat



32 | Schwarz matt · black mat

482

Tischleuchte · Table lamp

↑ 15 cm, Ø 9 cm
excl. 1 x E14, max. 40 W



591000107
591000132



Empfohlen:
recommended: LED E14, 3,5 W
320 lm, 3.000 K



983-40

TILL II

Metall, Glas matt · metal, mat glass ·
metale, verre mat · metaal, mat glas · metal, vidrio mate ·
metallo, vetro sabbiato · metal, sticla mata · metalli, mattalasi ·
metal, szkło matowane



On/Off Touch Funktion ·
On/Off Touch function



07 | Nickel matt · nickel mat



32 | Schwarz matt · black mat

Tischleuchte · Table lamp

↑ 14,5 cm, ↔ 10 x 15 cm
excl. 1 x E14, max. 40 W



590200107
590200132



Empfohlen:
recommended: LED E14, 3,5 W
320 lm, 3.000 K



983-40



DAVI II

Metall, Glas matt · metal, mat glass ·
 metale, verre mat · metaal, mat glas · metal, vidrio mate ·
 metallo, vetro sabbato · metal, sticla mata · metalli, matalasi ·
 metal, szkło matowane

 On/Off Touch Funktion ·
 On/Off Touch function

Empfohlen:
 recommended: LED E14, 3,5 W
 320 lm, 3.000 K



983-40



07 | Nickel matt ·
 nickel mat



32 | Schwarz matt ·
 black mat



Tischleuchte · Table lamp
 ↓ 15 cm, ↔ 10 x 15 cm
 excl. 1 x E14, max. 40 W



590100107
 590100132



MATS II

Nickel matt, Stoff · nickel mat, fabric ·
nickel mat, tissu · nikkel mat, textiel · níquel mate, tela ·
nichel opaco, tessuto · nichel mat, textil · harjattu teräs, tekstiili · nikiel mat, tkanina



On/Off Touch Funktion ·
On/Off Touch function

Empfohlen:
recommended: LED E14, 3,5 W
320 lm, 3.000 K



983-40



01 | Weiß · white



15 | Grün · green



42 | Anthrazit · anthacite

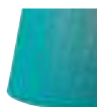

19 | Türkis · turquoise

Tischleuchte · Table lamp

↓ 24 cm, Ø 14 cm
excl. 1 x E14, max. 40 W



599700101
599700115
599700119
599700142



PIET II

Nickel matt, Stoff · nickel mat, fabric ·
nickel mat, tissu · nikkel mat, textiel · níquel mate, tela ·
nichel opaco, tessuto · nichel mat, textil · harjattu teräs, tekstiili · nikiel mat, tkanina



On/Off Touch Funktion ·
On/Off Touch function

Empfohlen:
recommended: LED E14, 3,5 W
320 lm, 3.000 K



983-40



01 | Weiß · white



02 | Schwarz · black



42 | Anthrazit · anthracite

Tischleuchte · Table lamp
↓ 35 cm, ↔ 12 x 12 cm
excl. 1 x E14, max. 40 W



591600101
591600102
591600142



AMSTERDAM

Metall, Weiß oder Schwarz · metal, white or black ·
 metale, blanc ou noir · metaal, wit of zwart · metal, blanco o negro ·
 metallo, bianco o nero · metal, alb sau negru · metalli, valkoinen tai musta ·
 metal, biały lub czarny



Tischleuchte · Table lamp
 ↑ max. 90 cm, ↗ max. 90 cm, Ø 18 cm
 incl. 1 x COB-LED, 5 W
 500 lm, 3.000 K



527920101 | Weiß · white
 527920102 | Schwarz · black



AVA

Kunststoff · plastic ·
 plastique · kunststof · plástico ·
 plastica · plastic · muovi · plastik



Lichtfarbe einstellbar ·
 Adjustable light color



Sensordimmer ·
 Sensor dimmer



USB Anschluss mit Ladefunktion ·
 Recharging USB connection



Memory Funktion ·
 Memory function



Tischleuchte · Table lamp
 ↓ 40,4 cm, ↔ 17,1 cm, ↗ 30,5 cm
 incl. SMD-LED, 5,2 W
 600 lm, 3.000 + 4.000 + 6.300 K



523090131 | Weiß matt · white mat
 523090132 | Schwarz matt · black mat

RODERIC

Metall, Anthrazit, Kunststoff · metal, anthracite, plastic ·
métal, anthracite, plastique · metaal, antraciet, kunststof ·
metal, antracita, plástico · metallo, antracite, plastica ·
metal, antracit, plastic · metalli, antrasiitti, muovi ·
metal, antracyt, plastik



488

Tischleuchte · Table lamp

↑ 50 cm, ↔ 19 cm, ↗ 55 cm
incl. 1 x SMD-LED, 6 W
800 lm, 3.000 K



527410142

VARIO

Metall, Kunststoff · metal, plastic ·
metale, plastique · metaal, kunststof · metal, plástico ·
metallo, plastica · metal, plastic · metalli, muovi · metal, plastik

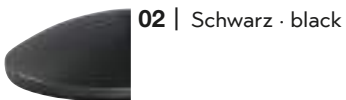

02 | Schwarz · black



87 | titanfarbig · titanium-coloured



Tischleuchte · Table lamp

↑ max. 64,5 cm, ↗ max. 50 cm
incl. SMD-LED, 3,6 W
200 lm, 3.000 K



522520102

522520187





RADO

Metall, Kunststoff · metal, plastic ·
 metale, plastique · metaal, kunststof · metal, plástico ·
 metallo, plastica · metal, plastic · metalli, muovi · metal, plastik



Lichtfarbe einstellbar ·
 Adjustable light color



4 fach TOUCH ·
 4 level Touch function



31 | Weiß matt · white mat



32 | Schwarz matt · black mat



+



Tischleuchte · Table lamp
 ↑ 70 cm, ↗ 38 cm
 incl. 1 x SMD-LED, 5 W
 700 lm, 3.000 + 4.000 + 5.000 K





527690131
 527690132



4 fach TOUCH ·
4 level Touch function

CURTIS

Altmessing, Nickel matt oder Messing matt · old brass, nickel mat or brass mat ·
laiton fumé, nickel mat ou laiton mat · oud brons, nikkel mat of messing mat · bronze viejo,
níquel mate o bronze mate · ottone invecchiato, nichel opaco o ottone satinato ·
bronz antic, nichel mat sau bronz mat · antiikkimessinki, harjattu teräs tai mattamessinki ·
patyna, nikiel mat lubmosiądz mat

-  **04** | Altmessing · old brass
-  **07** | Nickel matt · nickel mat
-  **08** | Messing matt · brass mat
-  **32** | Schwarz matt · black mat



Tischleuchte · Table lamp
↓ 35 cm, ↔ 18 cm, ↗ max. 15 cm
incl. SMD-LED, 4 W
380 lm, 3.000 K



579790104
579790107
579790108
579790108



Wandleuchte · Wall lamp
↓ 35 cm, ↔ 18 cm, ↗ max. 35 cm
incl. SMD-LED, 4 W
380 lm, 3.000 K



279770104
279770107
279770108
279770108



Integrierter Dimmer ·
Integrated dimmer



POLO

Kunststoff · plastic ·
plastique · kunststof · plástico · plastica · plastic · muovi · plastik

 Lichtfarbe einstellbar ·
Adjustable light color

 4 fach TOUCH ·
4 level Touch function



492

Tischleuchte · Table lamp

↓ 41 cm, ↗ 40 cm
incl. 1 x SMD-LED, 5 W
550 lm, 3.000 + 4.000 + 5.000 K



527090111 | Grau · grey

527090131 | Weiß matt · white mat



POLLY

Kunststoff · plastic ·
plastique · kunststof · plástico · plastica · plastic · muovi · plastik

 4 fach TOUCH ·
4 level Touch function



Tischleuchte · Table lamp

↓ 40 cm, ↔ 16 x 16 cm, ↗ 39 cm
incl. 1 x SMD, 4,8 W
700 lm, 3.000 K



573910101 | Weiß · white

573910106 | Chrom · chrome





LUPO

Kunststoff · plastic ·
 plastique · kunststof · plástico · plastica · plastic · muovi · plastik

 4 fach TOUCH ·
 4 level Touch function

 **01** | Weiß · white

 **02** | Schwarz · black



Tischleuchte · Table lamp
 ↑ 35 cm, Ø 13,5 cm, √ 30 cm
 incl. 1 x SMD-LED, 5 W
 550 lm, 3.500 K

527290101
 527290102



KIMI

Metall, Holz · metal, wood ·
 metale, bois · metaal, hout · metal, madera ·
 metallo, di legno · metal, lemn · metalli, puu · metal, drewno

Empfohlen:
 recommended: LED E27, 4 W
 320 lm, 3.000 K



986-40



Tischleuchte · Table lamp

↑ max. 50 cm, Ø 16 cm, √ max. 37,5 cm
 excl. 1 x E27, max. 42 W



508300131 | Weiß matt · white mat

508300132 | Schwarz matt · black mat



PERRY

Metall · metal ·
metale · metaal · metal · metallo · metal · metalli · metal

Empfohlen:
recommended: LED E27, 4,9 W
470 lm, 3.000 K



987-60



Tischleuchte · Table lamp
↑ 46 cm, ↔ 16 cm, ∅ 28 cm
excl. 1 x E27, max. 42 W



504900104 | Altmessing · old brass
504900107 | Nickel matt · nickel mat
504900131 | Weiß matt · white mat
504900132 | Schwarz matt · black mat

PRONTO

Metall, Kunststoff · metal, plastic ·
metale, plastique · metaal, kunststof · metal, plástico ·
metallo, plastica · metal, plastic · metalli, muovi · metal, plastik

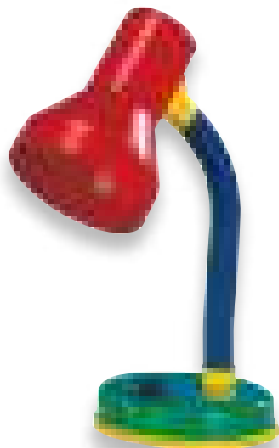
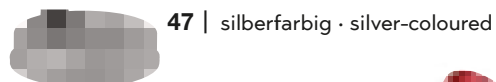
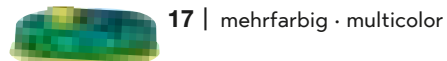

496

Tischleuchte · Table lamp

↑ 30 cm, Ø 13,1 cm, ∠ 22 cm
excl. 1 x E27, max. 18 W



5027011-01

5027011-17

5027011-47

FLEXO

Metall, Kunststoff · metal, plastic ·
metale, plastique · metaal, kunststof · metal, plástico ·
metallo, plastica · metal, plastic · metalli, muovi · metal, plastik

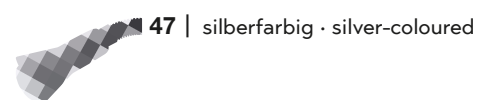
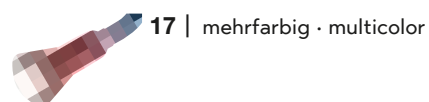

Tischleuchte · Table lamp

↑ 30 cm, ∠ 30 cm
excl. 1x E14, max. 18 W



5028010-01

5028010-02

5028010-17

5028010-47





TAJO

Metall · metal ·
metale · metaal · metal ·
metallo · metal · metalli · metal



 01 | Weiß · white

 47 | silberfarbig · silver-coloured

Tischleuchte · Table lamp
↓ 73,5 cm, Ø 16,8 cm, ↗ 51 cm
excl. 1 x E27, max. 40 W



5029010-01
5029010-47





Spotserien

Spots
Spotterie
Spots
Focos
Faretti
Spoturi
Spotit
Reflektorki



geeignet für Auf- und Einbau · suitable for both mounting and installation · adapté au montage et à l'installation · geschikt voor in en opbouw · apropiadas tanto para montaje como para instalación · ideale sia per montaggio e installazione · adecvate pentru aplicare și încorporare · sopii pinta- ja upposennukseen · odpowiednie zarówno do montażu jak i instalacji

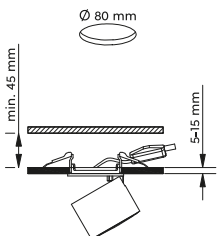

Strahler · Spot
 Ø 8,7 cm, ↑ 10,6 cm
 incl. SMD-LED, 5 W
 450 lm, 3.000 K
 incl. SMD-LED, 1,5 W
 110 lm, 3.000 K



652910131
 652910132

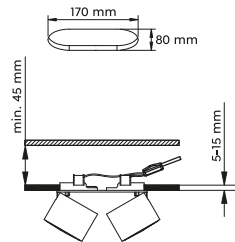

Strahler · Spot
 ↔ 18 x 8,7 cm, ↑ 10,6 cm
 incl. 2 x SMD-LED, 5 W
 2 x 450 lm, 3.000 K
 incl. 2 x SMD-LED, 1,5 W
 2 x 110 lm, 3.000 K



652910231
 652910232

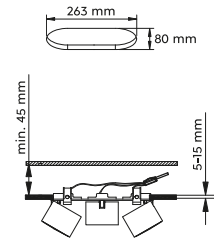

Strahler · Spot
 ↔ 27,3 x 8,7 cm, ↑ 10,6 cm
 incl. 3 x SMD-LED, 5 W
 3 x 450 lm, 3.000 K
 incl. 3 x SMD-LED, 1,5 W
 3 x 110 lm, 3.000 K



652910331
 652910332



31 | Weiß matt · white mat



32 | Schwarz matt · black mat



TAURUS

Metall, Weiß matt oder Schwarz matt · metal, white mat or black mat ·
 metale, blanc mat ou noir mat · metaal, wit mat of mat zwart · metal, estera blanca o estera negra ·
 metallo, bianco opaco o nero opaco · metal, alb mat sau negru mat · metalli, valkoinen matto tai musta matto · metal, biały mat lub czarny mat



Getrennt schaltbar ·
 Separately switchable



1x



2x



3x





Strahler · Spot
 ↔ 36 x 7 cm, ↑ 18,5 cm
 incl. 2 x SMD-LED, 4,3 W
 2 x 430 lm, 3.000 K



821470205



Strahler · Spot
 ↔ 50 x 7 cm, ↑ 18,5 cm
 incl. 3 x SMD-LED, 4,3 W
 3 x 430 lm, 3.000 K



821410305



Strahler · Spot
 ↔ 96,5 x 8 cm, ↑ 18,5 cm
 incl. 4 x SMD-LED, 4,3 W
 4 x 430 lm, 3.000 K



821410405



Strahler · Spot
 ↔ max.150 x 8 cm, ↑ 24 cm
 incl. 6 x SMD-LED, 4,3 W
 6 x 430 lm, 3.000 K



821410605



CLAPTON

Aluminium gebürstet, Chrom, Glas Weiß gewischt · brushed aluminium, chrome, glass white brushed glass · aluminium balayé, chrome, verre blanc balayé · geborsteld aluminium, chroom, wit geborsteld glas · aluminio pulido, cromo, blanco pulido · alluminio spazzolato, cromo, vetro bianco spazzolato · aluminiu lucios, crom, alb lucios · harjattu alumiini, kromi, lasi harjattu valkoinen · aluminium szczotkowane, chrom, szkło białe otarła



Strahler · Spot
 ↓ 20 x 7 cm, ↗ 16 cm
 incl. 1 x SMD-LED, 4,3 W
 430 lm, 3.000 K



821470105



Strahler · Spot
 ↔ 31 x 22 cm, ↓ 18,5 cm
 incl. 4 x SMD-LED, 4,3 W
 4 x 430 lm, 3.000 K



821430405



Strahler · Spot
 ↔ 70 x 50 cm, ↓ 23 cm
 incl. 5 x SMD-LED, 4,3 W
 5 x 430 lm, 3.000 K



621410505





Strahler · Spot
 ↓ 12 x 7,5 cm, ↗ 16 cm
 incl. SMD-LED, 6,5 W
 650 lm, 3.000 K



873170107
 873170131



Strahler · Spotp
 ↔ 28,5 x 9,5 cm, ↗ 16 cm
 incl. 2 x SMD-LED, 6,5 W
 2 x 650 lm, 3.000 K



873170207
 873170231



Strahler · Spot
 ↔ 45 x 9,5 cm, ↓ 16 cm
 incl. 3 x SMD-LED, 6,5 W
 3 x 650 lm, 3.000 K



873110307
 873110331

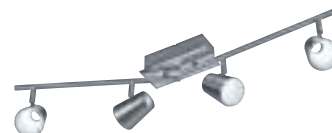

Strahler · Spot
 ↔ 81,5 x 8 cm, ↓ 20 cm
 incl. 4 x SMD-LED, 6,5 W
 4 x 650 lm, 3.000 K



873110407
 873110431



NARCOS

Nickel matt oder weiß · nickel mat or white ·
nickel mat ou blanc · nikkel mat of wit · níquel mate o blanco · nichel opaco o bianco ·
nichel mat sau alb · harjattu teräs tai valkoinen · nikiel mat lub biały



07 | Nickel matt · nickel mat



31 | Weiß matt · white mat



Strahler · Spot

↔ 177 x 10 cm, ↓ 23 cm
incl. 6 x SMD-LED, 6,5 W
6 x 650 lm, 3.000 K



873110607
873110631



Tischleuchte · Table lamp

↓ 38 cm, ↗ 23 cm
incl. SMD-LED, 4,7 W
470 lm, 3.000 K



573190107
573190131



Stehleuchte · Floor lamp

↓ 154 cm, ↔ 28 cm
incl. 3 x SMD-LED, 4,7 W
3 x 470 lm, 3.000 K



473190307
473190331





Strahler · Spot
 Ø 10 cm, ∇ 15 cm
 excl. 1 x GU10, max. 35 W



803500131
803500132



Strahler · Spot
 ↔ 24 x 7 cm, ↓ 15 cm
 excl. 2 x GU10, max. 35 W



803500231
803500232



Strahler · Spot
 ↔ 41 x 7 cm, ↓ 15 cm
 excl. 3 x GU10, max. 35 W



803500331
803500332



Strahler · Spot
 ↔ 24 x 24 cm, ↓ 15 cm
 excl. 4 x GU10, max. 35 W



803590431
803590432



PAGO

Metall, Weiß matt oder Schwarz matt · metal, white mat or black mat ·
 metale, blanc mat ou noir mat · metaal, wit mat of mat zwart ·
 metal, estera blanca o estera negra · metallo, bianco opaco o nero opaco ·
 metal, alb mat sau negru mat · metalli, valkoinen matto tai musta matto ·
 metal, biały mat lub czarny mat



31 | Weiß matt · white mat



32 | Schwarz matt · black mat



Empfohlen:
 recommended: LED GU10, 4,5 W
 345 lm, 3.000 K



956-55



Strahler · Spot
 ↔ 11 x 16 cm, ∅ 19 cm
 excl. 1 x GU10, max. 35 W



- 800700107
- 800700131
- 800700132



Strahler · Spot
 ↔ 28 x 16 cm, ∅ 19 cm
 excl. 2 x GU10, max. 35 W



- 800700207
- 800700231
- 800700232



Strahler · Spot
 ↔ 44 x 16 cm, ∅ 19 cm
 excl. 3 x GU10, max. 35 W



- 800700307
- 800700331
- 800700332



Strahler · Spot
 ↔ 60 x 16 cm, ∅ 19 cm
 excl. 4 x GU10, max. 35 W



- 800700407
- 800700431
- 800700432



LEON

Nickel matt, Weiß matt oder Schwarz matt · nickel mat, white mat or black mat ·
 nickel mat, blanc mat ou noir mat · nikkel mat, wit mat of mat zwart ·
 níquel mate, estera blanca o estera negra · nichel opaco, bianco opaco o nero opaco ·
 nichel mat, alb mat sau negru mat · harjattu teräs, valkoinen matto tai musta matto ·
 nikiel mat, biały mat lub czarny mat

Empfohlen:
 recommended: LED GU10, 4,5 W
 345 lm, 3.000 K



956-55



07 | Nickel matt · nickel mat



31 | Weiß matt · white mat



32 | Schwarz matt · black mat



Empfohlen:
recommended: LED GU10, 4,5 W
345 lm, 3.000 K



956-55

MARLEY

Metall, Schwarz-Gold · metal, black-gold ·
métal, noir et or · metaal, zwart-goud · metal, negro-oro ·
metallo, oro nero · metal, negru-auriu · metalli, musta-kulta · metal, czarno złoty



Strahler · Spot
↑ 12 x 12 cm, ↗ 15 cm
excl. 1 x GU10, max. 25 W



802400180



Strahler · Spot
↔ 30 x 9 cm, ↓ 15 cm
excl. 2 x GU10, max. 35 W



802400280



Strahler · Spot
↔ 48 x 9 cm, ↓ 15 cm
excl. 3 x GU10, max. 35 W



802400380



Strahler · Spot
↔ 24 x 24 cm, ↓ 15 cm
excl. 4 x GU10, max. 35 W



802430480

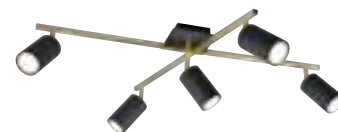

Strahler · Spot
↔ 77,4 x 57,4 cm, ↓ 22,4 cm
excl. 5 x GU10, max. 35 W



612400580





Strahler · Spot
 ↓ 12 x 12 cm, ↗ 15 cm
 excl. 1 x GU10, max. 25 W



802400101
 802400124
 802400132



Strahler · Spot
 ↔ 30 x 9 cm, ↓ 15 cm
 excl. 2 x GU10, max. 35 W



802400201
 802400224
 802400232



Strahler · Spot
 ↔ 48 x 9 cm, ↓ 15 cm
 excl. 3 x GU10, max. 35 W



802400301
 802400324
 802400332



Strahler · Spot
 ↔ 77,4 x 57,4 cm, ↓ 22,4 cm
 excl. 5 x GU10, max. 35 W



612400501
 612400532



MARLEY

Metall · metal ·
metale · metaal · metal · metallo · metal · metalli · metal



01 | Weiß · white



24 | rostfarbig · rusty



32 | Schwarz matt · black mat

Empfohlen:
recommended: LED GU10, 4,5 W
345 lm, 3.000 K



956-55



Wandleuchte · Wall lamp
↓ 18 x 6 cm, ↗ 8 cm
excl. 2 x GU10, max. 35 W



212400201
212400224
212400232



Strahler · Spot
↔ 24 x 24 cm, ↓ 15 cm
excl. 4 x GU10, max. 35 W



802430401
802430424
802430432



Strahler · Spot
 ↔ 12 cm, ↓ 12 cm, ↗ 15 cm
 excl. 1 x GU10, max. 25 W



802400104
 802400107



Strahler · Spot
 ↔ 30 x 9 cm, ↓ 15 cm
 excl. 2 x GU10, max. 35 W



802400204
 802400207



Strahler · Spot
 ↔ 48 x 9 cm, ↓ 15 cm
 excl. 3 x GU10, max. 35 W



802400304
 802400307



Strahler · Spot
 ↔ 24 x 24 cm, ↓ 15 cm
 excl. 4 x GU10, max. 35 W



802430404
 802430407



MARLEY

Metall · metal ·
metale · metaal · metal · metallo · metal · metalli · metal

Empfohlen:
recommended: LED GU10, 4,5 W
345 lm, 3.000 K



956-55



04 | Altmessing · old brass



07 | Nickel matt · nickel mat



Wandleuchte · Wall lamp
↓ 18 cm, ↔ 6 cm, ↗ 8 cm
excl. 2 x GU10, max. 35 W



212400204
212400207



Strahler · Spot
↔ 77,4 x 57,4 cm, ↓ 22,4 cm
excl. 5 x GU10, max. 35 W



612400504
612400507

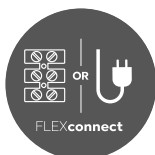
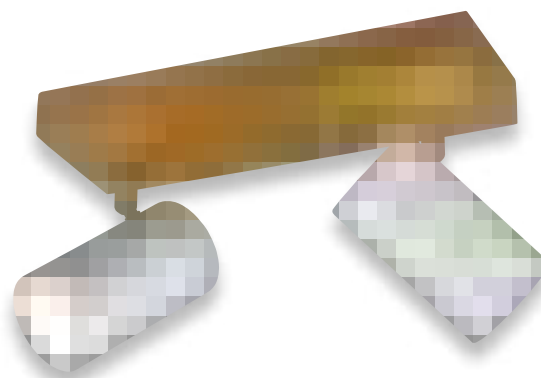
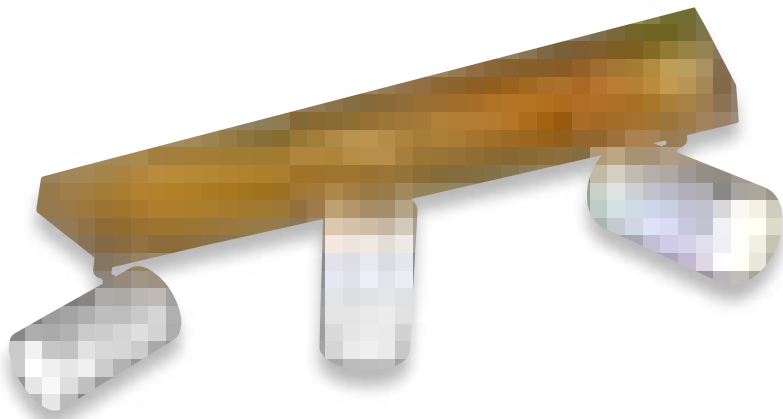

Seite/page 632



Wandleuchte · Wall lamp
 ↔ 12 x 9 cm, ↗ 16 cm
 excl. 1 x GU10, max. 15 W



812400107
 812400131
 812400132

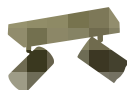

Deckenleuchte · Ceiling lamp
 ↔ 26 x 9 cm, ↓ 16 cm
 excl. 2 x GU10, max. 35 W



812400207
 812400231
 812400232



Deckenleuchte · Ceiling lamp
 ↔ 44 x 9 cm, ↓ 16 cm
 excl. 3 x GU10, max. 35 W



812400307
 812400331
 812400332



Deckenleuchte · Ceiling lamp
 ↔ 22 x 22 cm, ↓ 16 cm
 excl. 4 x GU10, max. 35 W



812400407
 812400431
 812400432



MARLEY

Metall, Holz · metal, wood ·
 metale, bois · metaal, hout · metal, madera ·
 metallo, di legno · metal, lemn · metalli, puu · metal, drewno

Empfohlen:
 recommended: LED GU10, 4,5 W
 345 lm, 3.000 K



956-55



07 | Nickel matt · nickel mat



31 | Weiß matt · white mat



32 | Schwarz matt · black mat



Strahler · Spot
 Ø 9 cm, ↗ 16 cm
 incl. 1 x LED G9, 3 W
 250 lm, 3.000 K



871570107



Strahler · Spot
 ↔ 34 cm, ↑ 18 cm
 incl. 2 x LED G9, 3 W
 2 x 250 lm, 3.000 K



871510207



Strahler · Spot
 Ø 29,5 cm, ↑ 18 cm
 incl. 3 x LED G9, 3 W
 3 x 250 lm, 3.000 K



871590307



Strahler · Spot
 ↔ 90 cm, ↑ 19 cm
 incl. 4 x LED G9, 3 W
 4 x 250 lm, 3.000 K



871510407



CARICO

Nickel matt, Glas Weiß gewischt · nickel mat, glass white brushed glass ·
 nickel mat, verre blanc balayé · nikkel mat, wit geborsteld glas ·
 níquel mate, blanco pulido · nichel opaco, vetro bianco spazzolato ·
 nichel mat, alb lucios · harjattu teräs, lasi harjattu valkoinen ·
 nikiel mat, szkło białe otarla



Dimmbar ·
Dimmable



incl.: LED G9, 3 W
250 lm, 3.000 K



Strahler · Spot
 ↔ 150 cm, ↑ 19 cm
 incl. 6 x LED G9, 3 W
 6 x 250 lm, 3.000 K



871510607



Strahler · Spot
 Ø 10 cm, ↗ 19 cm
 incl. 1 x LED E14, 5 W
 400 lm, 3.000 K

871010107
 871010108



Strahler · Spot
 ↔ 33 cm, ↓ 19 cm
 incl. 2 x LED E14, 5 W
 2 x 400 lm, 3.000 K

871010207
 871010208



Strahler · Spot
 ↔ 55 cm, ↓ 19 cm
 incl. 3 x LED E14, 5 W
 3 x 400 lm, 3.000 K

871010307
 871010308



Strahler · Spot
 ↔ 88 cm, ↓ 19 cm
 incl. 4 x LED E14, 5 W
 4 x 400 lm, 3.000 K

871010407
 871010408



Strahler · Spot
 ↔ 180 cm, ↓ 21 cm
 incl. 6 x LED E14, 5 W
 6 x 400 lm, 3.000 K

871010607
 871010608



LEVISTO

Nickel matt oder Messing matt, Glas alabasterfarbig ·
 nickel mat or brass mat, alabaster-coloured glass · nickel mat ou laiton mat, verre couleur albâtre · nikkell mat of messing mat, albastkleurig glas ·
 níquel mate o bronze mate, vidrio de color alabastro · nichel opaco o ottone satinato, vetro colore alabastro · nichel mat sau bronz mat, sticla
 culoare alabastru · harjattu teräs tai mattamessinki, lasi alabasteri väri · nikiel mat lub mosiądz mat, szkło alabaster kolor



incl.
 LED E14, 4,9 W
 470 lm, 3.000 K

983-60



07 | Nickel matt · nickel mat



08 | Messing matt · brass mat



Strahler · Spot
 Ø 30 cm, ↑ 21 cm
 incl. 3 x LED E14, 5 W
 3 x 400 lm, 3.000 K

871090307
871090308



MICHAEL

Nickel matt · nickel mat ·
nickel mat · nikkell mat · níquel mate · nichel opaco ·
nichel mat · harjattu teräs · nikiel mat · mat nikel



Strahler · Spot
↓ 10,6 x 6 cm, ↗ 13 cm
excl. 1 x GU10, max. 28 W



803000107



Strahler · Spot
↔ 32 x 5 cm, ↓ 13 cm
excl. 2 x GU10, max. 28 W



803000207



Strahler · Spot
↔ 54 x 5 cm, ↓ 13 cm
excl. 3 x GU10, max. 28 W



803000307



Strahler · Spot
Ø 25,5 cm, ↓ 15 cm
excl. 3 x GU10, max. 28 W



803090307

Empfohlen:
recommended: LED GU10, 4,5 W
345 lm, 3.000 K



956-55

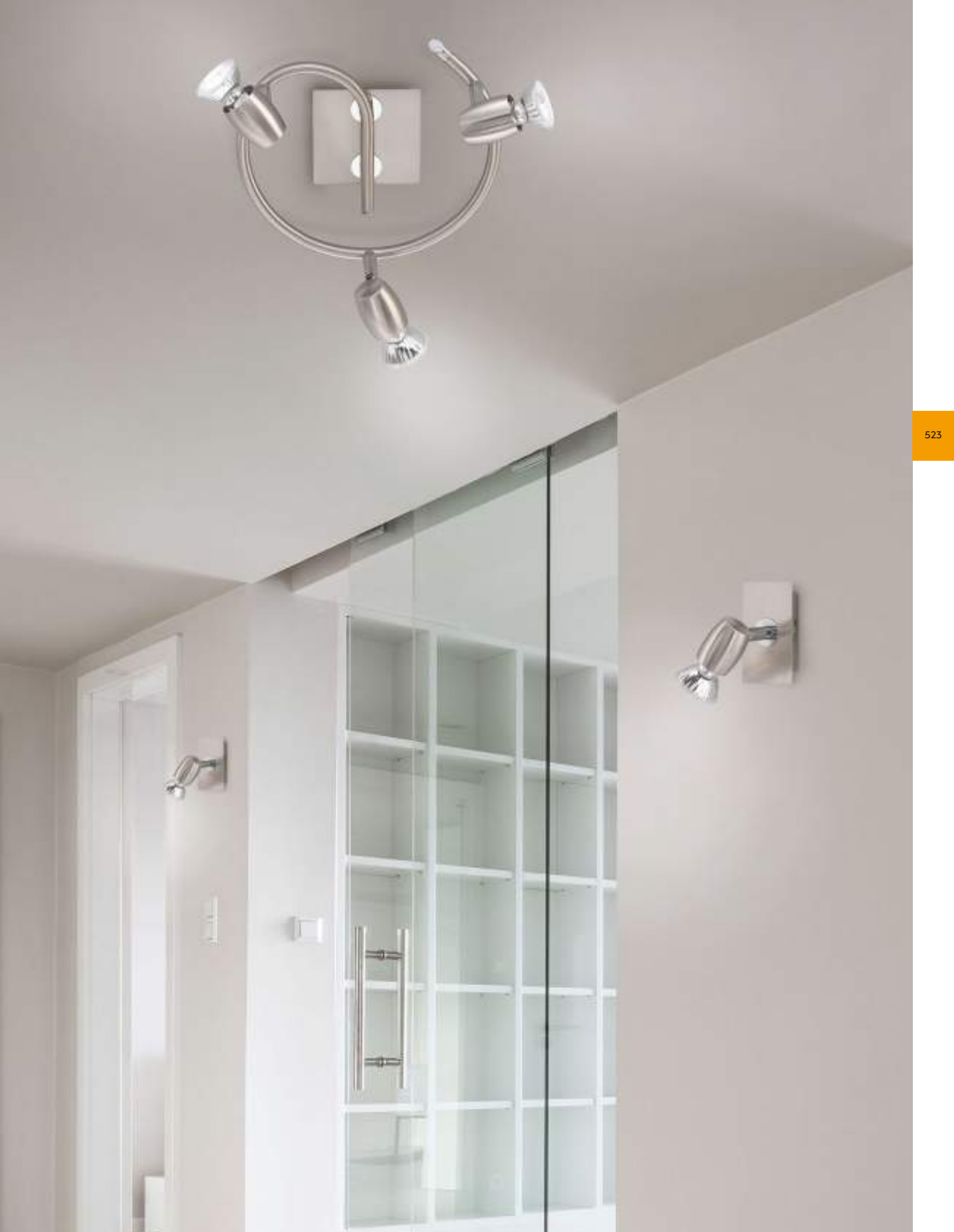



Empfohlen:
recommended: LED GU10, 4,5 W
345 lm, 3.000 K



956-55

CONCRETE

Beton, Grau · concrete, grey ·
béton, gris · beton, grijs · hormigón, gris · cemento, grigio ·
beton, gri · betoni, harmaa · beton, popielaty · beton, gri



Strahler · Spot
↔ 10 x 15 cm, ↗ 18 cm
excl. 1 x GU10, max. 42 W



802500178



Strahler · Spot
↔ 23 x 10 cm, ↑ 18 cm
excl. 2 x GU10, max. 42 W



802500278



Strahler · Spot
↔ 35 x 10 cm, ↑ 18 cm
excl. 3 x GU10, max. 42 W



802500378



Empfohlen:
recommended: Filament LED E14, 4 W
470 lm, 3.000 K



989-400

HOUSTON

Metall, Schwarz/goldfarbig · metal, black/gold ·
metale, noir/ro · metaal, zwart/goud · metal, negro/oro ·
metallo, nero/oro · metal, negru/aur · metalli, musta/kultaa ·
metal, czarny/złota



Strahler · Spot
↔ 9,5 x 12 cm, ∅ 17 cm
excl. 1 x E14, max. 40 W



800300132



Strahler · Spot
↔ 36,5 cm, ↓ 19 cm
excl. 2 x E14, max. 40 W



800300232



Strahler · Spot
↔ 69,5 cm, ↓ 19 cm
excl. 4 x E14, max. 40 W



800300432



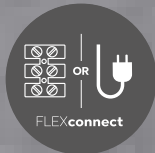

Seite/page 632

Empfohlen:
recommended: Filament LED E14, 4 W
470 lm, 2.700 K



983-400



Strahler · Spot
 ↓ 22,7 cm, ↔ 10 cm, ∠ 15,7 cm
 excl. 1 x E14, max. 40 W



811900131
811900132



Strahler · Spot
 ↔ 40 x 13,8 cm, ↓ 22,8 cm
 excl. 2 x E14, max. 40 W



811900231
811900232



Strahler · Spot
 ↔ 57 x 13,8 cm, ↓ 22,8 cm
 excl. 3 x E14, max. 40 W



811900331
811900332



ROXIE

Metall, weiß matt oder schwarz matt, Chrom · metal, white mat or black mat, chrome ·
 Métal, Blanc mat ou Noir mat, Chrome · Metaal, Wit mat of Mat zwart, Chroom ·
 Metal, Estera blanca o Estera negra, Cromo · Metallo, Bianco opaco o Nero opaco, Cromo ·
 Metal, Alb mat sau Negru mat, Crom · Metalli, mattavalkoinen tai mattamusta, Kromi ·
 Metal, Biały mat lub Czarny mat, Chrom



31 | Weiß matt · white mat



32 | Schwarz matt · black mat



Tischleuchte · Table lamp
 ↓ 43 cm, ↔ 17 cm, ∅ 22,5 cm
 excl. 1 x E14, max. 40 W



511900131
511900132



Stehleuchte · Floor lamp
 ↓ 155 cm, ↔ 43 cm, ∅ 23 cm
 excl. 2 x E14, max. 40 W



411900231
411900232

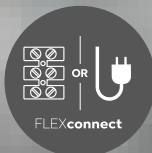

Seite/page 632

Empfohlen:
recommended: Filament LED E14, 4 W
470 lm, 2.700 K



983-400

STEAM

Metall, Weiß antik · metal, antique white ·
Métal, Blanc antique · Metaal, Antiek wit · Metal, Blanco decapé ·
Metallo, Bianco anticato · Metal, Alb antic · Metalli, Antiikkivalkoinen ·
Metal, Antyczny biały



Strahler · Spot
↑ 14 cm, ↔ 10 cm, ↗ 15 cm
excl. 1 x E14, max. 40 W



813400127



Strahler · Spot
↔ 30 x 10 cm, ↑ 17,5 cm
excl. 2 x E14, max. 40 W



813400227



Strahler · Spot
↔ 73 x 10 cm, ↑ 17,5 cm
excl. 4 x E14, max. 40 W



813400427



Strahler · Spot
Ø 30 cm, ↑ 15,5 cm
excl. 3 x E14, max. 40 W



813430327

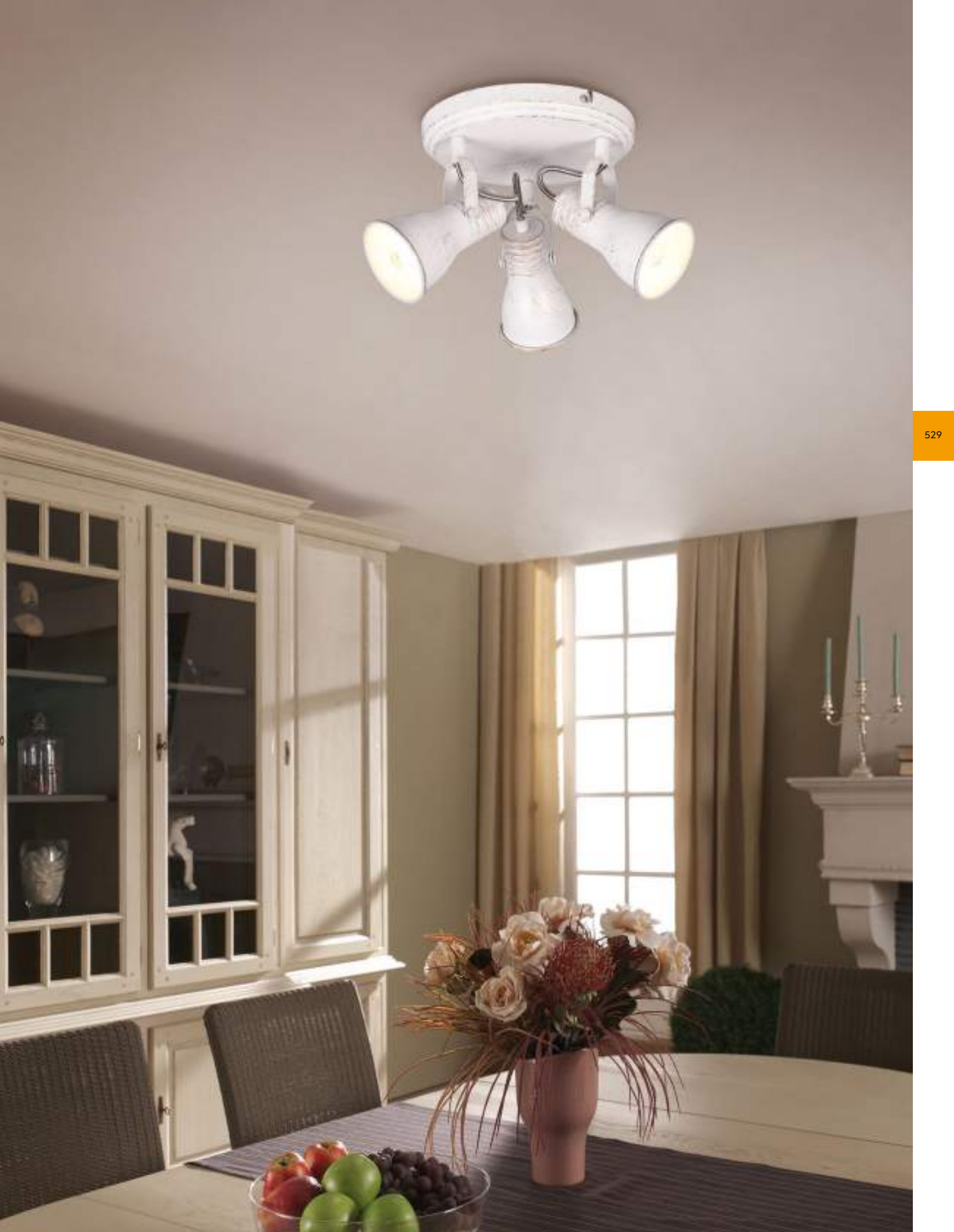





2-Phasen- Schienensystem

2-phase track system

Système de voie à deux phases

2-fase-spoorsysteem

Sistema de rieles en 2 fases

Sistema a binario bifase

Sistem de piste cu 2 faze

2-vaihekiskojärjestelmä

2-fazowy system prowadnic



Für jede Raumsituation die ideale Beleuchtung.

Das DUOline 2-Phasen-Schiensystem ist äußerst flexibel und bietet zahlreiche Möglichkeiten zur individuellen Lichtgestaltung. Die verschiedenen Spots und Pendelleuchten lassen sich frei in der Schiene platzieren und können so gezielt in allen Wohnbereichen eingesetzt werden. Das 2-Phasensystem ermöglicht, dass mit nur einem Stromanschluss zwei Beleuchtungsgruppen getrennt voneinander geschaltet oder gedimmt werden können.

Bitte beachten! Um das 2-Phasensystem nutzen zu können, wird eine vieradrige Stromleitung benötigt.

The ideal lighting for every room situation.

The DUOline 2-phase track system is extremely flexible and offers numerous possibilities for individual lighting arrangements. The various spotlights and pendant lamps can be positioned as desired in the track and can therefore be used in all living areas. The 2-phase system allows two lighting groups to be switched or dimmed independently of each other with just one power connection.

Please note! A four-core power cable is required to be able to use the 2-phase system.

L'éclairage parfait pour chaque type de pièces.

Le système de rails biphasés DUOline est extrêmement flexible et offre de nombreuses possibilités de conception individuelle de l'éclairage. Les différents projecteurs et luminaires suspendus peuvent être positionnés librement dans le rail et peuvent donc être utilisés de manière spécifique dans tous vos espaces d'habitation. Le système biphasé permet de commuter ou de faire varier l'intensité de deux groupes d'éclairage séparément l'un de l'autre avec un seul branchement électrique.

Attention ! Un câble d'alimentation à quatre conducteurs est nécessaire pour utiliser le système biphasé.

Voor elke situatie de ideale verlichting.

Het DUOline-2-fase-spoorsysteem is uiterst flexibel en biedt talrijke mogelijkheden voor een individuele lichtvormgeving. De diverse spots en hanglampen kunnen willekeurig in het spoor geplaatst worden en kunnen zo doelgericht in alle woonruimtes gebruikt worden. Het 2-fase-systeem maakt mogelijk dat met slechts één stroomaansluiting twee verlichtingsgroepen apart van elkaar geschakeld of gedimd kunnen worden.

Opgelet! Om het 2-twee-fasesysteem te kunnen gebruiken is een vierdradige stroomleiding nodig.

La iluminación ideal para cada habitación.

El sistema de rieles en 2 fases DUOline es extraordinariamente flexible y ofrece numerosas posibilidades de diseño lumínico individuales. Los distintos puntos y lámparas de péndulo le permiten colocar los rieles libremente y por eso pueden utilizarse en toda la vivienda. El sistema de rieles en 2 fases permite que se activen o atenúen dos grupos de lámparas separados con un solo cable de corriente.

¡Por favor, recuerde! Para poder utilizar el sistema en 2 fases, será necesario un cable de corriente de cuatro filamentos.

L'illuminazione ideale per qualsiasi esigenza abitativa.

Il sistema a binario bifase DUOline è estremamente flessibile e offre numerose possibilità per la progettazione individuale dell'illuminazione. I vari faretti e lampade a sospensione possono essere posizionati liberamente nel binario e possono quindi essere utilizzati in modo specifico in tutti gli ambienti abitativi. Il sistema bifase consente di commutare o dimmerare due gruppi di illuminazione separatamente l'uno dall'altro con una sola connessione di alimentazione.

Attenzione! Per utilizzare il sistema bifase è necessario un cavo di alimentazione a quattro conduttori.

Iluminatul ideal pentru fiecare încăpere.

Sistemul de piste cu 2 faze DUOline este deosebit de flexibil și oferă numeroase posibilități pentru structurarea individuală a luminii. Diferitele spot-uri și lustre pot fi amplasate liber pe pistă și pot fi astfel utilizate ținând în toate zonele spațiilor de locuit. Sistemul cu 2 faze permite comutarea și reglarea intensității pentru două grupuri de corpuri de iluminat separate, folosind un singur racord electric.

Vă rugăm să aveți în vedere! Pentru a putea utiliza sistemul cu 2 faze, este necesară utilizarea unui cablu electric cu patru fire.

Ihanteellinen valaistus jokaiseen huoneen käyttötilanteeseen.

DUOline 2-vaihekiskojärjestelmä on erittäin joustava ja tarjoaa lukuisia vaihtoehtoja yksilölliseen valaistuksen suunnitteluun. Eri spotti- ja ripustettavat valaisimet voidaan sijoittaa mihin tahansa kiskoon, joten niitä voidaan käyttää kaikissa asuintiloissa. 2-vaihejärjestelmä mahdollistaa kahden valaistusryhmän kytkemisen tai himmentämisen erikseen yhdellä sähköliitännällä.

Huomaa! Kaksivaihejärjestelmän käyttämiseksi tarvitaan nelijohtiminen sähkönsyöttö.

Idealne oświetlenie do każdej sytuacji w pomieszczeniu.

Dwufazowy system prowadnic DUOline jest niezwykle elastyczny i oferuje wiele opcji indywidualnego projektowania oświetlenia. Różne skupienia i lampy wiszące można umieścić w dowolnym miejscu na szynie, dzięki czemu można je stosować we wszystkich pomieszczeniach mieszkalnych. System 2-fazowy umożliwia osobne przełączanie lub przyciemnianie dwóch grup oświetlenia za pomocą tylko jednego podłączenia zasilania.

Proszę pamiętać! Dla korzystania z systemu 2-fazowego, wymagana jest czteroprzewodowa linia zasilania.

ÜBERSICHT KOMPONENTEN

Component overview · Aperçu des composants · Overzicht van componenten ·

Vista general por componentes · Panorâmica dei componentes · Prezentare generală a componentelor ·

Komponentteihin yleiskuvaus · Przegląd komponentów

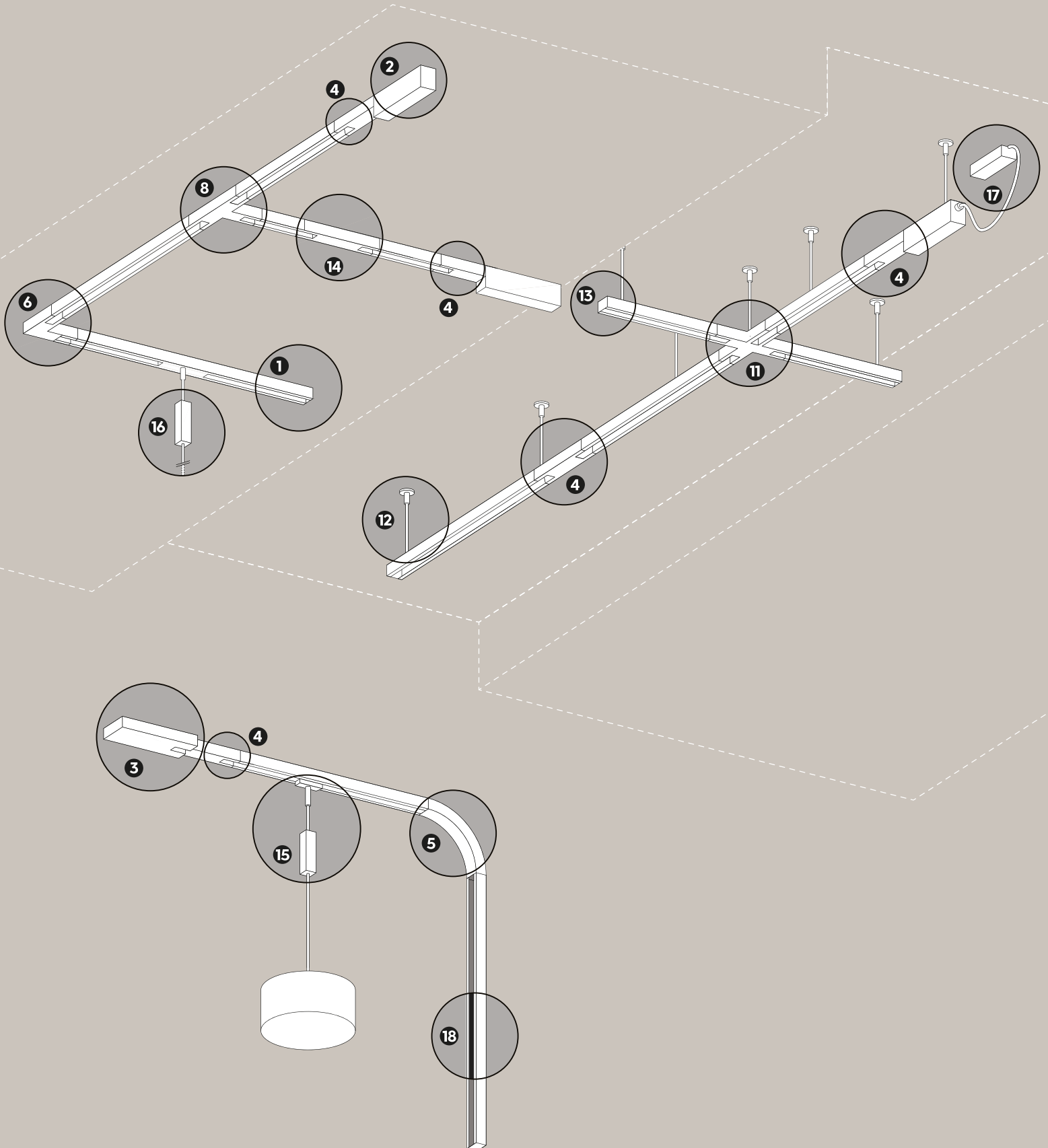

Die Vorteile von DUOline im Überblick:

- Individuelle Lichtgestaltung
- Nur ein Stromanschluss erforderlich
- Kein Trafo notwendig
- Leuchten frei kombinierbar und leicht versetzbar
- Zwei verschiedene Lichtszenarien
- Getrenntes Schalten und Dimmen
- Für Decken- und Wandmontage geeignet

Bei der Planung bitte unbedingt die Position des Schutzleiters beachten, der innerhalb des Systems durchgängig verbunden sein muss.

Advantages of DUOline at a glance:

- individual lighting arrangements
- only one power connection required
- no need for a transformer
- lamps can be freely combined and are easily positioned
- two different lighting scenarios
- separate switching and dimming
- suitable for ceilings and walls

When planning, please pay attention to the position of the protective conductor, which must be connected continuously within the system.

Les avantages de DUOline en un coup d'œil :

- Conception individuelle de l'éclairage
- Une seule connexion électrique requise
- Pas besoin de transformateur
- Les luminaires peuvent être librement combinés et facilement déplacés
- Deux scénarios lumineux différents
- Commutation et variateur de lumière séparés
- Convient pour le montage au plafond et au mur

Lors de la planification, veuillez prêter une attention particulière à la position du conducteur de protection, qui doit être connecté en permanence dans le système.

Overzicht van de voordelen van DUOline:

- Individuele lichtvormgeving
- Slechts één stroomaansluiting nodig
- Geen transformator nodig
- Lampen willekeurig combineerbaar en gemakkelijk verplaatsbaar
- Twee verschillende lichtscenario's
- Apart schakelen en dimmen
- Geschikt voor plafond- en muurmontage

Let bij de planning absoluut op de positie van de beschermende geleider die binnen het systeem ononderbroken verbonden moet zijn.

Las ventajas de DUOline en resumen:

- Diseño lumínico individual
- Solo un cable de corriente necesario
- Ningún transformador necesario
- Lámpara combinables libremente y fácilmente desplazable
- Dos escenarios lumínicos diferentes
- Activación y atenuación separadas
- Adecuado para su montaje en techo y pared

Al planificar, por favor, tenga en cuenta la posición de la toma de tierra, que debe estar conectado a lo largo de todo el sistema.

I vantaggi di DUOline in sintesi:

- Progettazione individuale dell'illuminazione
- È necessario un solo collegamento di alimentazione
- Non è necessario alcun trasformatore
- Le lampade possono essere liberamente combinate e facilmente spostate
- Due differenti scenari di illuminazione
- Commutazione e dimmerazione separate
- Adatto per il montaggio a soffitto e a parete

In fase di progettazione, prestare attenzione alla posizione del conduttore di protezione, che deve essere collegato in modo continuo all'interno dell'impianto.

Avantajele DUOline dintr-o privire:

- Structurarea individualizată a luminii
- Este necesară o singură conexiune electrică
- Nu este necesar un transformator
- Lămpile pot fi combinate liber și pot fi deplasate cu ușurință
- Două scenarii de iluminat diferite
- Comutare și reglare a intensității separate
- Adecvat pentru montajul pe plafon și pe perete

La planificare, luați neapărat în considerare poziția conductorului de protecție, care trebuie să fie conectat continuu în interiorul sistemului.

DUOlinen edut lyhyesti:

- Yksilöllinen valaistussuunnittelu
- Vaaditaan vain yksi sähköliitäntä
- Muuntajaa ei tarvita
- Valaisimia voidaan yhdistellä vapaasti ja siirtää helposti
- Kaksi erilaista valaistusskenaariota
- Erillinen kytkentä ja himmennys
- Sopii katto- ja seinäasennukseen

Huomioi suunnittelussa koko järjestelmään kytkettävän suojamaadoituksen sijainti.

Zalety DUOline w skrócie:

- Indywidualny projekt oświetlenia
- Wymagane jest tylko jedno połączenie zasilania
- Nie wymaga transformatora
- Oprawy można dowolnie łączyć i łatwo przemieszczać
- Dwa różne scenariusze oświetlenia
- Oddzielne włączanie i ściemnianie
- Nadaje się do montażu sufitowego i ściennego

Podczas projektowania należy zwrócić uwagę na położenie przewodu ochronnego, który musi być podłączony w całym systemie.

SCHIENE · TRACK

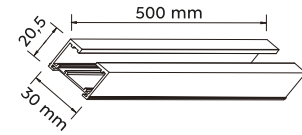

1 SCHIENE 50 CM · TRACKING 50 CM

Metall · metal
max. 2 x 600 W

700131 | Weiß matt · white mat
700132 | Schwarz matt · black mat
700187 | titanfarbig · titan

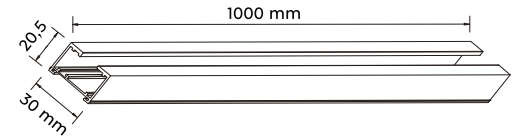

1 SCHIENE 100 CM · TRACKING 100 CM

Metall · metal
max. 2 x 600 W

700231 | Weiß matt · white mat
700232 | Schwarz matt · black mat
700287 | titanfarbig · titan

Die maximale Montagelänge beträgt 30 Meter pro Einspeisung, bei einer Gesamtleistung von max. 600 Watt pro Phase.
The maximum installation length is 30 metres per power feed, with a total capacity of max. 600 watts per phase.

EINSPEISUNG · POWER SUPPLY

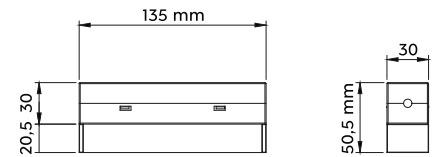

2 MITTEL-/END-EINSPEISUNG · MIDDLE-/ENDPOINT POWER SUPPLY

Kunststoff · plastic
max. 2 x 600 W

701031 | Weiß matt · white mat
701032 | Schwarz matt · black mat
701087 | titanfarbig · titan

Die Mittel-/Endeinspeisung wird direkt über dem Stromauslass angebracht und ermöglicht, Schienen auf einer Seite oder auf beiden Seiten anzuschließen.
Zur Stromversorgung der Schienen wird immer ein Verbinder benötigt (Pos. 4-8).
The middle/end feed is mounted directly over the power outlet and enables tracks to be connected on one or both sides.
A connector is always required to power the rails (Pos. 4-8).

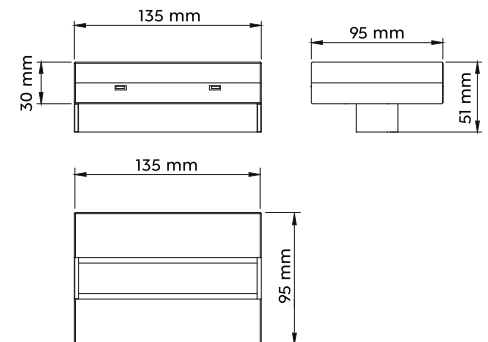

3 MITTEL-/END-EINSPEISUNG MIT ELEKTRONISCHEM PHASENWECHSLER · MIDDLE-/ENDPOINT POWER SUPPLY WITH ELECTRONIC PHASE CHANGER

Kunststoff · plastic
max. 2 x 200 W

701131 | Weiß matt · white mat
701132 | Schwarz matt · black mat
701187 | titanfarbig · titan

Mittels elektronischem Phasenwechsler lassen sich die zwei Phasen auch bei dreidadrigen Stromleitungen getrennt Schalten und Dimmen.
Zur Stromversorgung der Schienen wird immer ein Verbinder benötigt (Pos. 4-8).
Using an electronic phase changer, the two phases can be switched and dimmed separately, even with three-core power cables.
A connector is always required to power the rails (Pos. 4-8).

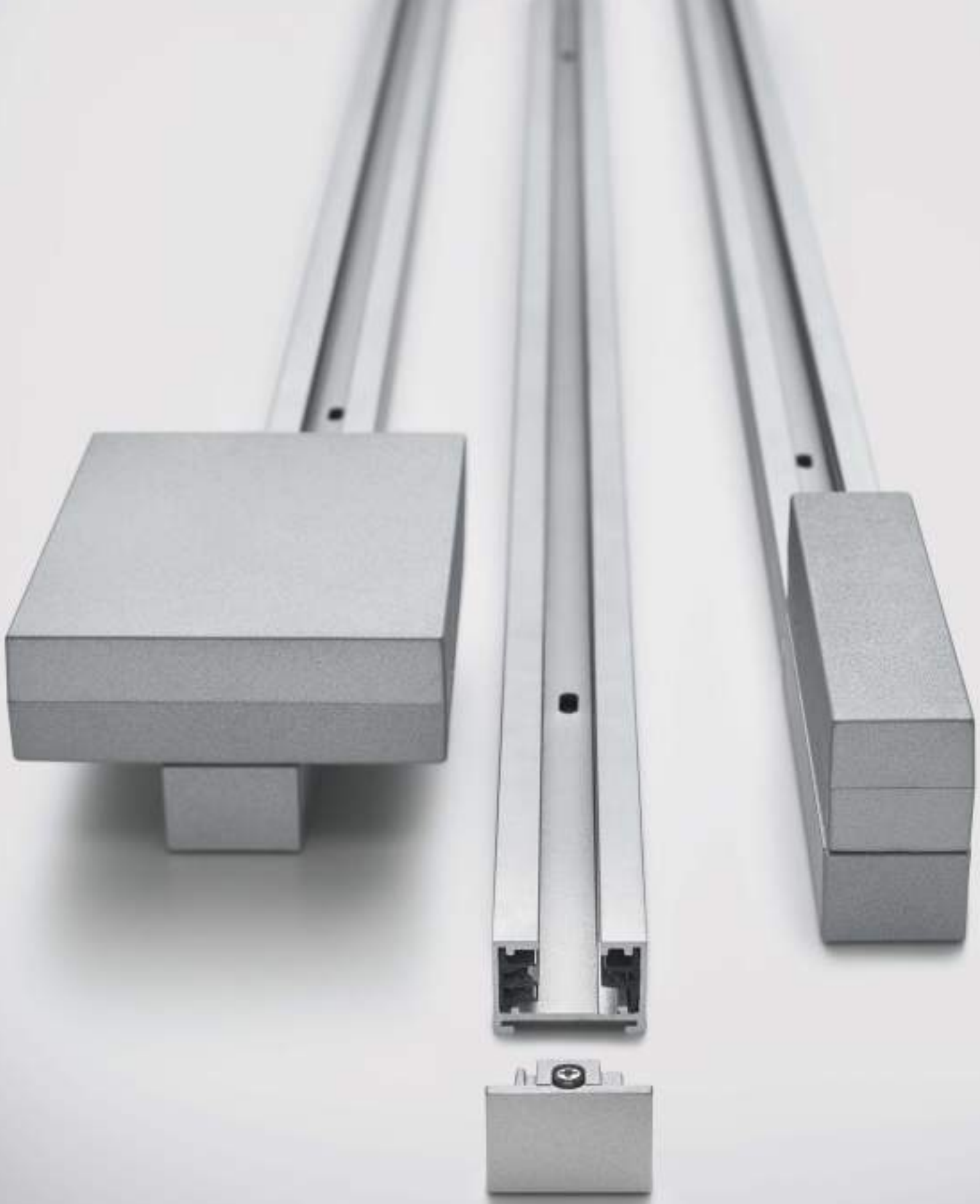



VERBINDER · CONNECTOR



4 LÄNGSVERBINDER · LINE CONNECTOR

Kunststoff · plastic
max. 2 x 600 W

702131 | Weiß matt · white mat
702132 | Schwarz matt · black mat
702187 | titanfarbig · titan

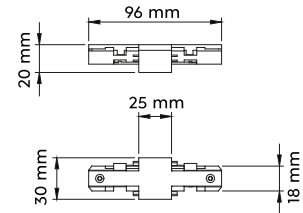

Verbindet zwei Schienen für gerade Strecken miteinander.
Connects two rails together for straight sections.



5 FLEX-VERBINDER · FLEX CONNECTOR

Kunststoff · plastic
max. 2 x 600 W

702031 | Weiß matt · white mat
702032 | Schwarz matt · black mat
702087 | titanfarbig · titan

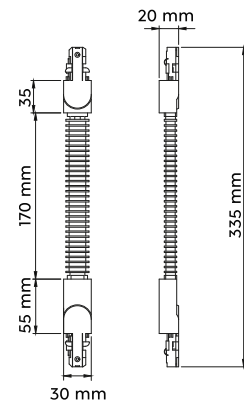

Verbindet zwei Schienen in einem beliebigen Winkel miteinander und ermöglicht die Verbindung zwischen Decken- und Wandmontage.
Connects two rails together at any angle and makes possible a connection between ceiling and wall mounting.



6 L-VERBINDER - SCHUTZLEITER INNEN · L-CONNECTOR - INNER PROTECTIVE CONDUCTOR

Kunststoff · plastic
max. 2 x 600 W

702231 | Weiß matt · white mat
702232 | Schwarz matt · black mat
702287 | titanfarbig · titan

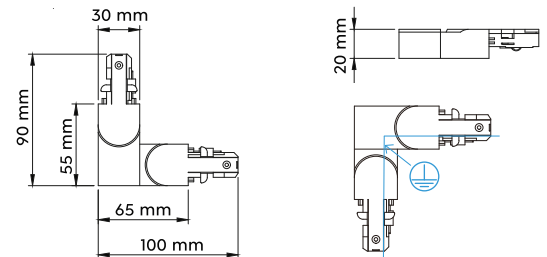

7 L-VERBINDER (TYP A) - SCHUTZLEITER AUSSEN · L-CONNECTOR (TYPE A) - OUTER PROTECTIVE CONDUCTOR

Kunststoff · plastic
max. 2 x 600 W

702231A | Weiß matt · white mat
702232A | Schwarz matt · black mat
702287A | titanfarbig · titan

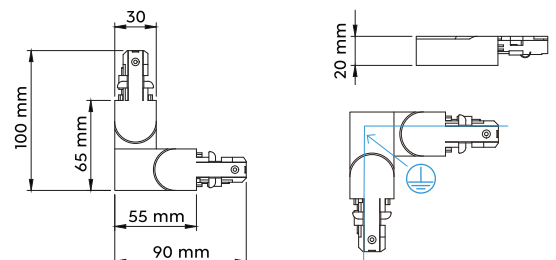

Verbindet zwei Schienen im rechten Winkel miteinander.
Connects two rails together at right angles.

Bei der Planung bitte unbedingt die Position des Schutzleiters beachten, der innerhalb des Systems durchgängig verbunden sein muss.

When planning, please pay attention to the position of the protective conductor, which must be connected continuously within the system.

Lors de la planification, veuillez prêter une attention particulière à la position du conducteur de protection, qui doit être connecté en permanence dans le système.

Let bij de planning absoluut op de positie van de beschermende geleider die binnen het systeem ononderbroken verbonden moet zijn.

Al planificar, por favor, tenga en cuenta la posición de la toma de tierra, que debe estar conectado a lo largo de todo el sistema.

In fase di progettazione, prestare attenzione alla posizione del conduttore di protezione, che deve essere collegato in modo continuo all'interno dell'impianto.

La planificare, luați neapărat în considerare poziția conductorului de protecție, care trebuie să fie conectat continuu în interiorul sistemului.

Huomioi suunnittelussa koko järjestelmään kytkettävän suojausjohtuksen sijainti.

Podczas projektowania należy zwrócić uwagę na położenie przewodu ochronnego, który musi być podłączony w całym systemie.

Beispiel A
Example A.

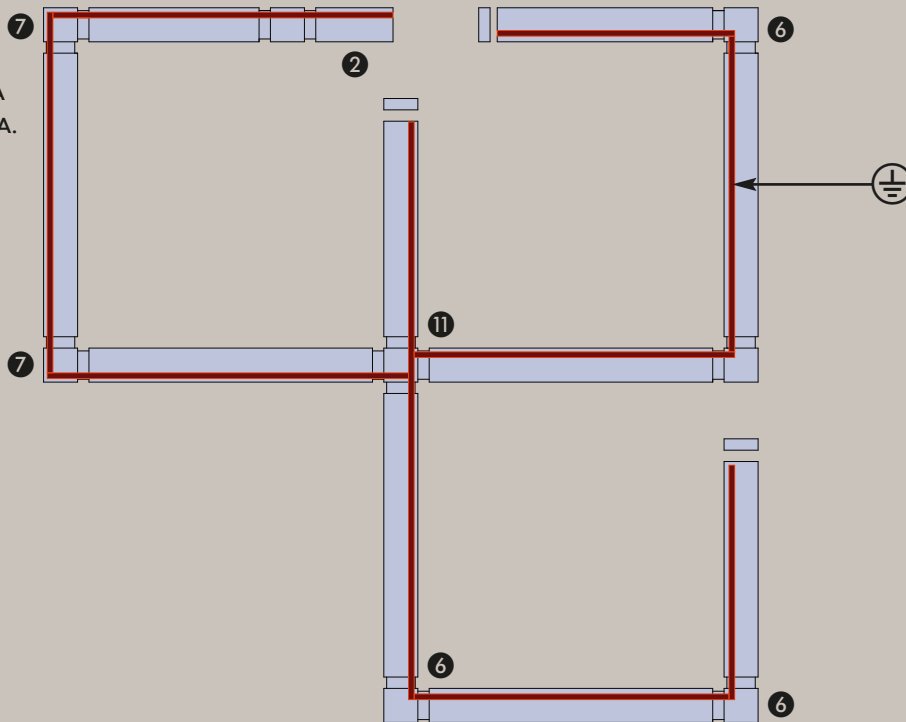

Beispiel B
Example B.

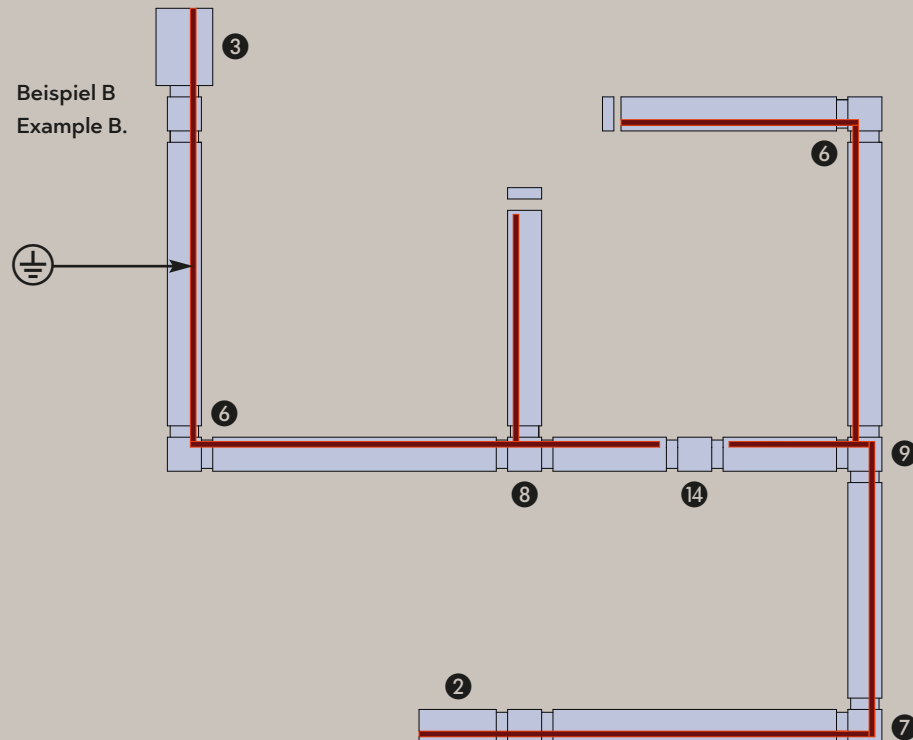

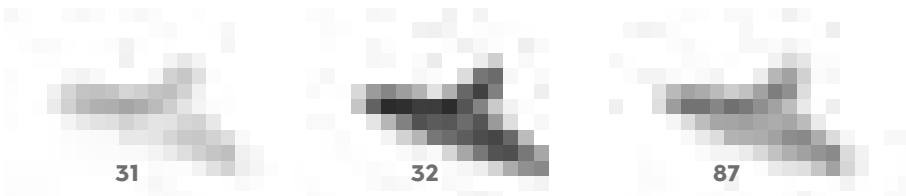

8 T-VERBINDER - SCHUTZLEITER RECHTS · T-CONNECTOR - RIGHT PROTECTIVE CONDUCTOR

Kunststoff · plastic
max. 2 x 600 W

- 702331 | Weiß matt · white mat
- 702332 | Schwarz matt · black mat
- 702387 | titanfarbig · titan

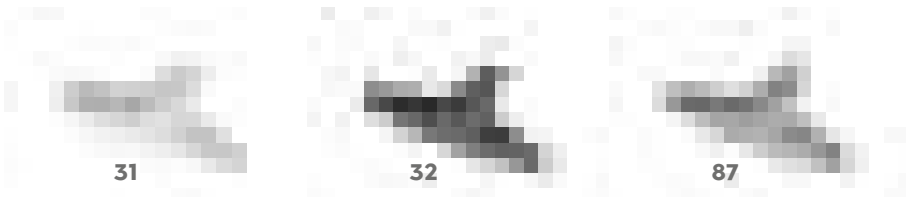
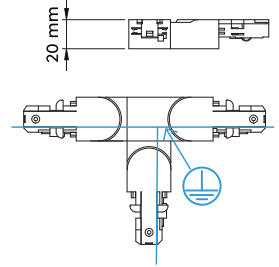
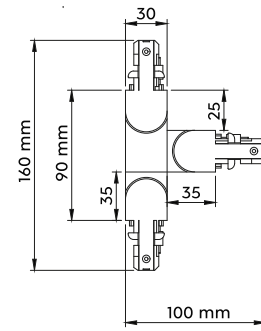

9 T-VERBINDER (TYP A) - SCHUTZLEITER LINKS · T-CONNECTOR (TYPE A) - LEFT PROTECTIVE CONDUCTOR

Kunststoff · plastic
max. 2 x 600 W

- 702331A | Weiß matt · white mat
- 702332A | Schwarz matt · black mat
- 702387A | titanfarbig · titan

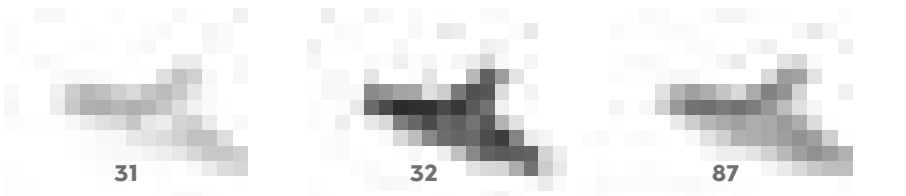
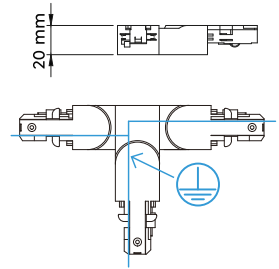
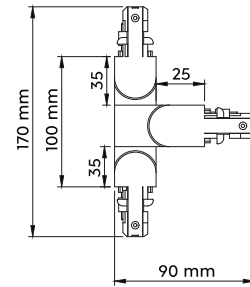

10 T-VERBINDER (TYP B) - SCHUTZLEITER LINKS · T-CONNECTOR (TYPE B) - LEFT PROTECTIVE CONDUCTOR

Kunststoff · plastic
max. 2 x 600 W

- 702331B | Weiß matt · white mat
- 702332B | Schwarz matt · black mat
- 702387B | titanfarbig · titan

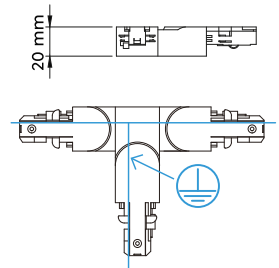
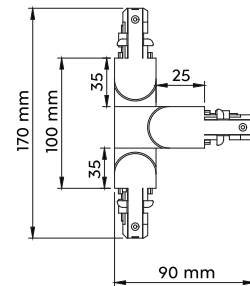

Verbindet drei Schienen im rechten Winkel miteinander.
Connects three rails together at right angles.

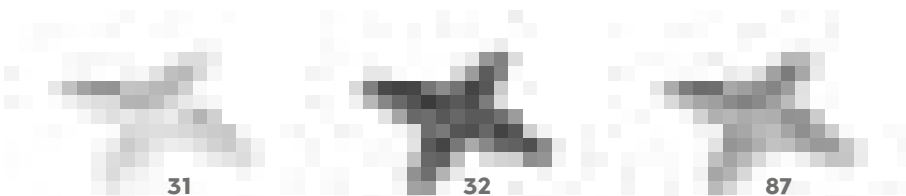

11 X-VERBINDER · X-CONNECTOR

Kunststoff · plastic
max. 2 x 600 W

- 702431 | Weiß matt · white mat
- 702432 | Schwarz matt · black mat
- 702487 | titanfarbig · titan

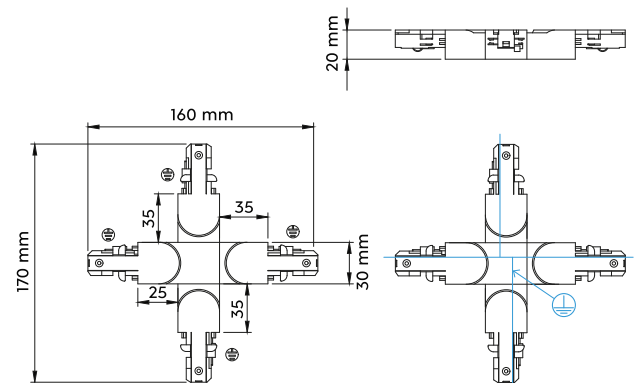

Verbindet vier Schienen im rechten Winkel miteinander.
Connects four tracks together at right angles to each other.

ZUBEHÖR · ACCESSORIES



31



32



87

12 DISTANZHALTER SET · SUSPENSION SET

Kunststoff · plastic

- 703131 | Weiß matt · white mat
- 703132 | Schwarz matt · black mat
- 703187 | titanfarbig · titan

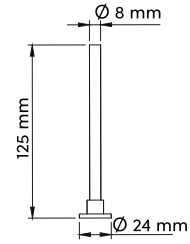

31



32



87

12 DISTANZHALTER SET · SUSPENSION SET

Kunststoff · plastic

- 703231 | Weiß matt · white mat
- 703232 | Schwarz matt · black mat
- 703287 | titanfarbig · titan

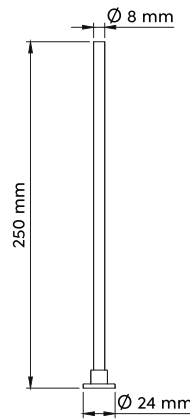

31



32



87

13 ENDKAPPEN · END CAPS

Kunststoff · plastic

- 703031 | Weiß matt · white mat
- 703032 | Schwarz matt · black mat
- 703087 | titanfarbig · titan

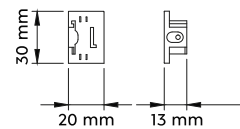

31



32



87

14 ISOLATOR · ISOLATOR

Kunststoff · plastic
max. 2 x 600 W

- 702531 | Weiß matt · white mat
- 702532 | Schwarz matt · black mat
- 702587 | titanfarbig · titan

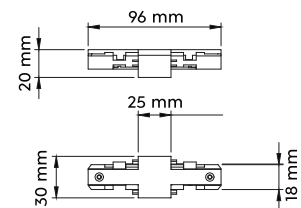

Mittels Isolator können zwei separate Schaltkreise optisch zu einem System verbunden werden.
Using an isolator, two separate circuits can be optically connected to form one system.

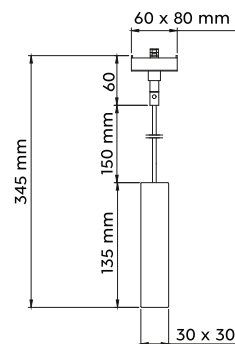

15 PENDEL-ADAPTER · PENDULAR ADAPTER

Kunststoff · plastic
max. 60 W

- 703531 | Weiß matt · white mat
- 703532 | Schwarz matt · black mat
- 703587 | titanfarbig · titan

Dieser Pendel-Adapter ermöglicht es, herkömmliche Pendelleuchten in das DUOLine Schienensystem zu integrieren.
This pendular adapter makes it possible for conventional pendular lamps to be integrated into the DUOLine track system.



16 KABELKÜRZER · CABLE SHORTENER

Kunststoff · plastic

- 703331 | Weiß matt · white mat
- 703332 | Schwarz matt · black mat
- 703387 | titanfarbig · titan

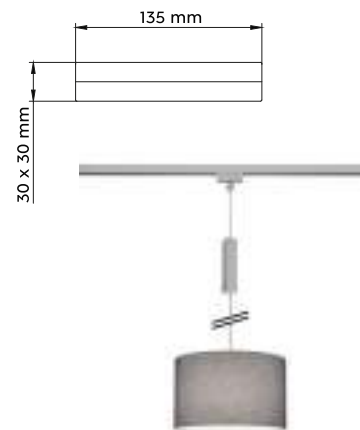

Ermöglicht das Kürzen der Kabel von Pendelleuchten.
Makes a shortening of the pendal lamp cable possible.



17 FLEXIBLE STROMVERSORGUNG · FLEX POWER SUPPLY

Kunststoff · plastic
max. 2 x 600 W

- 701231 | Weiß matt · white mat
- 701232 | Schwarz matt · black mat
- 701287 | titanfarbig · titan

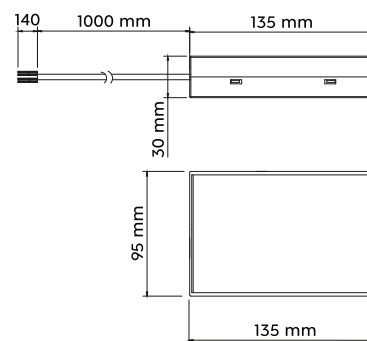

Die flexible Stromversorgung wird benötigt, wenn die Schienen nicht direkt über den Stromauslass verlegt werden können.
Nur in Verbindung mit einer Mittel-/Endeinspeisung.
The flexible power supply is required if the rails cannot be mounted directly over the power outlet.
A connector is always required to power the rails (Pos. 4-8).

18 ABDECKSCHIENE · SAFETY COVER STRIP

Kunststoff · plastic
↔ 100 x 1,4 cm, ∠ 0,5 cm

- 703952 | Transparent · transparent

ABDECKPLATTE · COVER PLATE

Metall · metal
↑ 0,1 cm, Ø 1 cm

- 703431 | Weiß matt · white mat



RADIATOR

Metall · metal · metale · metaal · metal · metallo · metal · metalli · metal

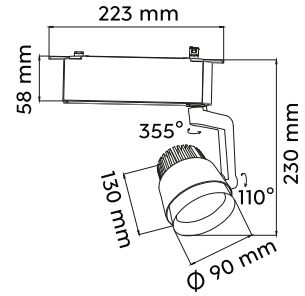
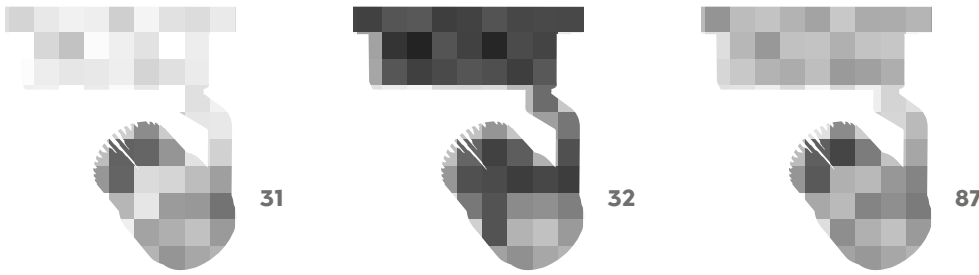

STRAHLER · SPOT
incl. SMD-LED, 15 W
1.270 lm, 2.300 + 3.000 + 4.000 K



78030131 | Weiß matt · white mat
78030132 | Schwarz matt · black mat
78030187 | titanfarbig · titan

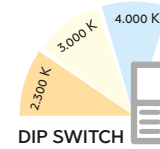

544

LEON

Metall · metal · metale · metaal · metal · metallo · metal · metalli · metal

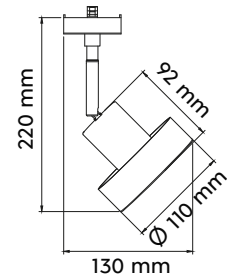

STRAHLER · SPOT
excl. 1 x GU10, max. 25 W



78070107 | Nickel matt · nickel mat
78070131 | Weiß matt · white mat
78070132 | Schwarz matt · black mat

Empfohlen:
recommended: LED GU10, 5 W
400 lm, 3.000 K



956-5936

ROUBAIX

Metall · metal · metale · metaal · metal · metallo · metal · metalli · metal

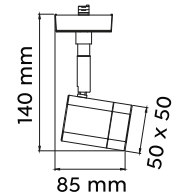
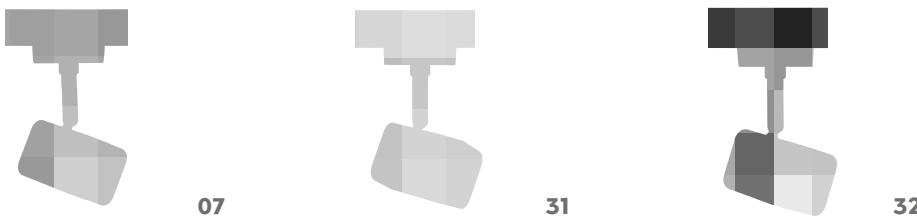

STRAHLER · SPOT
incl. SMD-LED, 4 W
400 lm, 3.000 K



78150107 | Nickel matt · nickel mat
78150131 | Weiß matt · white mat
78150132 | Schwarz matt · black mat





MARLEY

Metall · metal · metale · metaal · metal · metallo · metal · metalli · metal



07



08



31



32

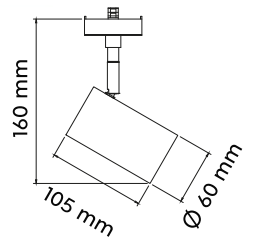

STRAHLER · SPOT
excl. 1 x GU10, max. 25 W



- 78240107 | Nickel matt · nickel mat
- 78240108 | Messing matt · brass mat
- 78240131 | Weiß matt · white mat
- 78240132 | Schwarz matt · black mat



07



08



31



32

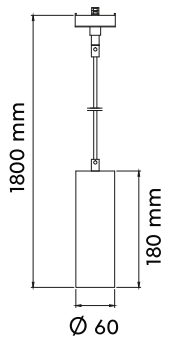

PENDELLEUCHE · PENDANT
excl. 1 x GU10, max. 25 W



- 73240107 | Nickel matt · nickel mat
- 73240108 | Messing matt · brass mat
- 73240131 | Weiß matt · white mat
- 73240132 | Schwarz matt · black mat



PAROS

Metall · metal · metale · metaal · metal · metallo · metal · metalli · metal



07



31



32

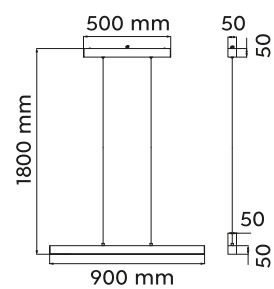

PENDELLEUCHE · PENDANT
incl. SMD-LED, 29 W
3.400 lm, 3.000 K

73043107 | Nickel matt · nickel mat
73043131 | Weiß matt · white mat
73043132 | Schwarz matt · black mat



ANTIBES

Metall, Glas Weiß · metal, glass white · metale, verre blanc ·
metaal, glas wit · metal, vidrio blanco · metallo, vetro bianco ·
metal, sticla alb · metalli, lasi valkoinen · metal, szkło biały

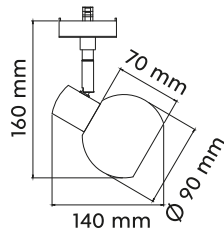

STRAHLER · SPOT
excl. 1 x GU10, max. 25 W



78170107 | Nickel matt · nickel mat

ONTARIO

Glas Weiß · glass white · verre blanc ·
glas wit · vidrio blanco · vetro bianco ·
sticla alb · lasi valkoinen · szkło biały

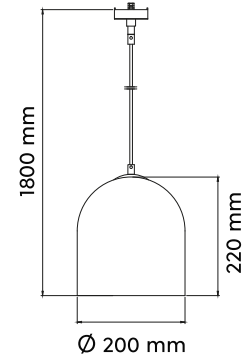

PENDELLEUCHTE · PENDANT
excl. 1 x E14, max. 25 W



73520101 | weiß · white

548

DIALLO

Metall · metal · metale · metaal · metal · metallo · metal · metalli · metal

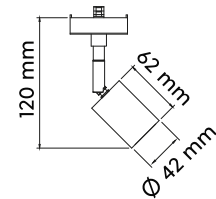

STRAHLER · SPOT
excl. 1 x E27, max. 25 W



78010107 | Nickel matt · nickel mat
78010131 | Weiß matt · white mat
78010132 | Schwarz matt · black mat

TOSH

Metall, Holz · metal, wood · metale, bois · metaal, hout · metal, madera ·
metallo, di legno · metal, lemn · metalli, puu · metal, drewno

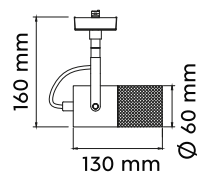

STRAHLER · SPOT
excl. 1 x E14, max. 25 W



78430132 | Schwarz matt · black mat

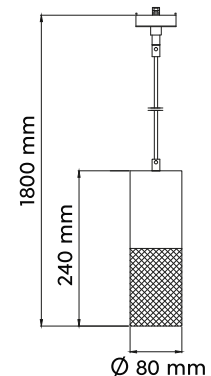

PENDELLEUCHTE · PENDANT
excl. 1 x E27, max. 25 W



73430132 | Schwarz matt · black mat



PANEL

Kunststoff · plastic · plastique · kunststof · plástico · plastica · plastic · muovi · plastik

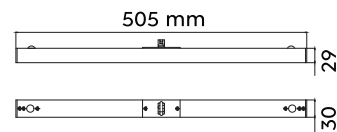

LED-PANEL
incl. SMD-LED, 6 W
850 lm, 3.000 K



77020131 | Weiß matt · white mat
77020132 | Schwarz matt · black mat
77020187 | titanfarbig · titan

550

CAMILLUS

Kunststoff · plastic · plastique · kunststof · plástico · plastica · plastic · muovi · plastik



LED-PANEL
incl. SMD-LED, 9 W
900 lm, 3.000 K



76921031 | Weiß matt · white mat
76921032 | Schwarz matt · black mat
76921087 | titanfarbig · titan

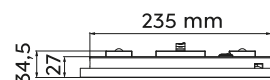

LED-PANEL
incl. SMD-LED, 13 W
1.400 lm, 3.000 K



76921531 | Weiß matt · white mat
76921532 | Schwarz matt · black mat
76921587 | titanfarbig · titan



HOTEL

Stoffschild · fabric shade · abat-jour tissu · Stoffen kap · Pantalla de tela · paralume in tessuto · abajur textil · kangas varjostin · Klosz z materiału

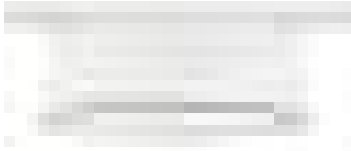

01



11

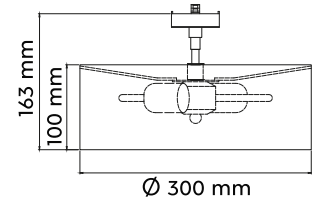

DECKENLEUCHE · CEILING LAMP

excl. 2 x E27, max. 25 W



76390201 | Weiß · white

76390211 | Grau · grey

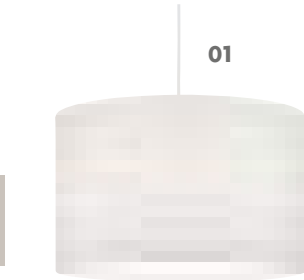

01

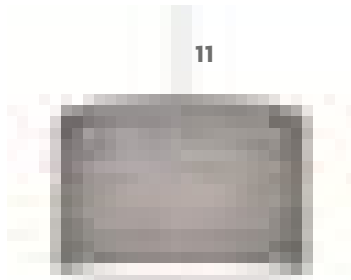

11

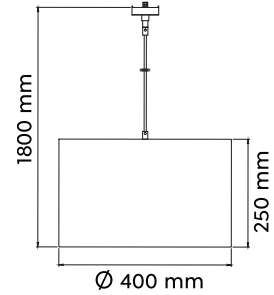

552

PENDELLEUCHE · PENDANT

excl. 1 x E27, max. 25 W



73330101 | Weiß · white

73330111 | Grau · grey

TOMMY

Stoffschild · fabric shade · abat-jour tissu · Stoffen kap · Pantalla de tela · paralume in tessuto · abajur textil · kangas varjostin · Klosz z materiału



01

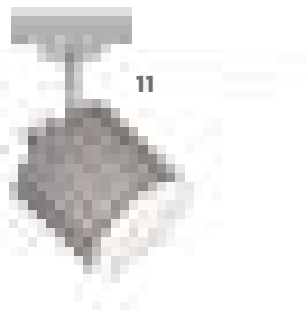

11



79

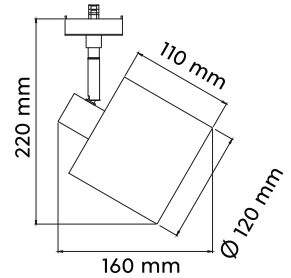

STRAHLER · SPOT

excl. 1 x E14, max. 25 W



78330101 | Weiß · white

78330111 | Grau · grey

78330179 | goldfarbig · gold

JIMMY

Metall, Schwarz · metal, black · metale, noir · metaal, zwart · metal, negro · metallo, nero · metal, negro · metalli, musta · metal, czarny



PENDELLEUCHE · PENDANT

excl. 1 x E27, max. 25 W



73120102 | Schwarz-Gold · black-gold

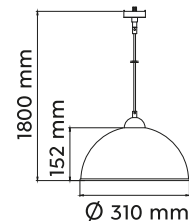



HOSTEL

Stoffschild · fabric shade · abat-jour tissu · Stoffen kap · Pantalla de tela · paralume in tessuto · abajur textil · kangas varjostin · Klosz z materiału

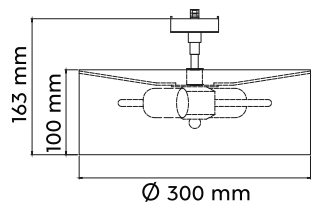

DECKENLEUCHTE · CEILING LAMP

excl. 2 x E27, max. 25 W

76820280 | Schwarz-Gold · black-gold

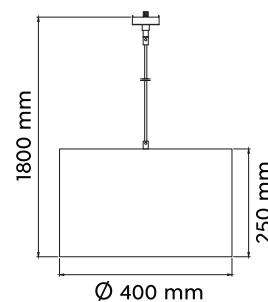

PENDELLEUCHTE · PENDANT

excl. 1 x E27, max. 25 W

73820180 | Schwarz-Gold · black-gold







Einbauleuchten

Recessed lights

Spots encastrés

Inbouwspots

Focos empotrables

Faretti incasso

Spoturi incastrate

Upotetut spotit

Oprawy wbudowane

AURA

Kunststoff, Chrom, Weiß matt oder Schwarz matt · plastic, chrome, white mat or black mat ·
 plastique, chrome, blanc mat ou noir mat · kunststof, chrom, wit mat of mat zwart · plástico, cromo, estera blanca o estera negra ·
 plastica, cromo, bianco opaco o nero opaco · plastik, crom, alb mat sau negru mat · muovi, kromi, mattavalkoinen tai mattamusta ·
 plastik, chrom, biały mat lub czarny mat



06



31



32

Einbauleuchte · Recessed light

556
 Ø 8,2 cm, ↑ 4 cm
 incl. 1 x SMD, 5 W
 450 lm, 3.000 K



652310106 | Chrom · chrome

652310131 | Weiß matt · white mat

652310132 | Schwarz matt · black mat

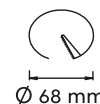
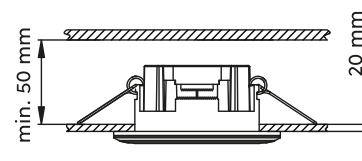

06



31



32

Einbauleuchte · Recessed light

Ø 14,8 cm, ↑ 3,8 cm
 incl. 1 x SMD, 10 W
 1.040 lm, 3.000 K



652410106 | Chrom · chrome

652410131 | Weiß matt · white mat

652410132 | Schwarz matt · black mat

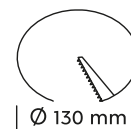
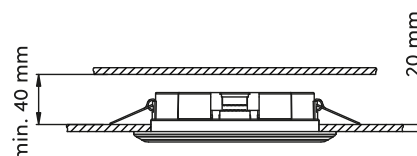

1x

2x

3x



Getrennt schaltbar · Separately switchable
 Interrupteurs séparés · Gescheiden schakelbaar ·
 Interruptores separados · Interruttori separati ·
 Intreruptoare separate · Erikseen kytkettävisä ·
 Oddzileny przełącznik



CORE

Kunststoff, Chrom, Weiß matt oder Schwarz matt · plastic, chrome, white mat or black mat ·
 plastique, chrome, blanc mat ou noir mat · kunststof, chrom, wit mat of mat zwart · plástico, cromo, estera blanca o estera negra ·
 plastica, cromo, bianco opaco o nero opaco · plastik, crom, alb mat sau negru mat · muovi, kromi, mattavalkoinen tai mattamusta ·
 plastik, chrom, biały mat lub czarny mat



06



31



32

Einbauleuchte · Recessed light
 Ø 8,2 cm, ↑ 3,5 cm
 incl. 1 x SMD, 5 W
 450 lm, 3.000 K

652510106 | Chrom · chrome
 652510131 | Weiß matt · white mat
 652510132 | Schwarz matt · black mat

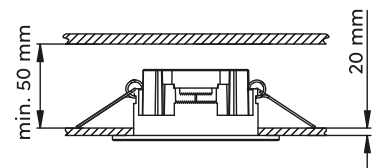

06



31



32

Einbauleuchte · Recessed light
 Ø 14,8 cm, ↑ 3,3 cm
 incl. 1 x SMD, 10 W
 1.040 lm, 3.000 K

652610106 | Chrom · chrome
 652610131 | Weiß matt · white mat
 652610132 | Schwarz matt · black mat

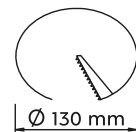
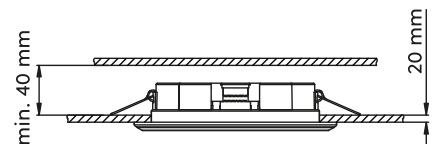

1x

2x

3x



Getrennt schaltbar · Separately switchable
 Interrupteurs séparés · Gescheiden schakelbaar ·
 Interruptores separados · Interruttori separati ·
 Intrerupatoare separate · Erikseen kytkettävisä ·
 Oddzileny przełącznik

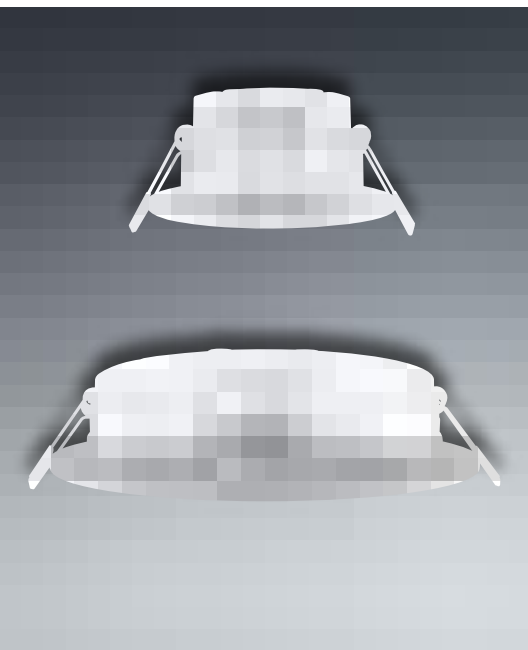

PAMIR

Metall · metal ·
metale · metaal · metal · metallo · metal · metalli · metal ·

 Dimmbar ·
Dimmable



06



07



31



32

560

Einbauleuchte · Recessed light

↔ 8,5 x 8,5 cm, ↑ 5,4 cm
incl. 1 x SMD, 5,5 W
345 lm, 3.000 K



650410106 | Chrom · chrome
650410107 | Nickel matt · nickel mat
650410131 | Weiß matt · white mat
650410132 | Schwarz matt · black mat

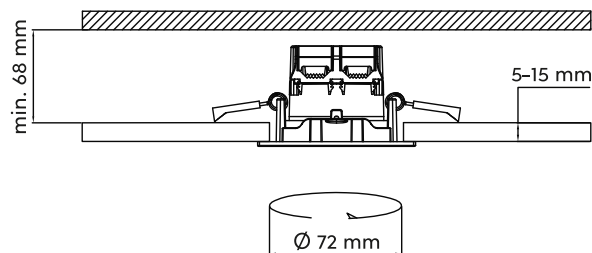

06



07



31



32

Einbauleuchte · Recessed light

Ø 8,5 cm, ↑ 5,4 cm
incl. 1 x SMD, 5,5 W
345 lm, 3.000 K



650510106 | Chrom · chrome
650510107 | Nickel matt · nickel mat
650510131 | Weiß matt · white mat
650510132 | Schwarz matt · black mat

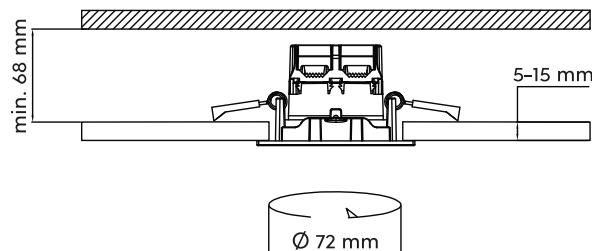

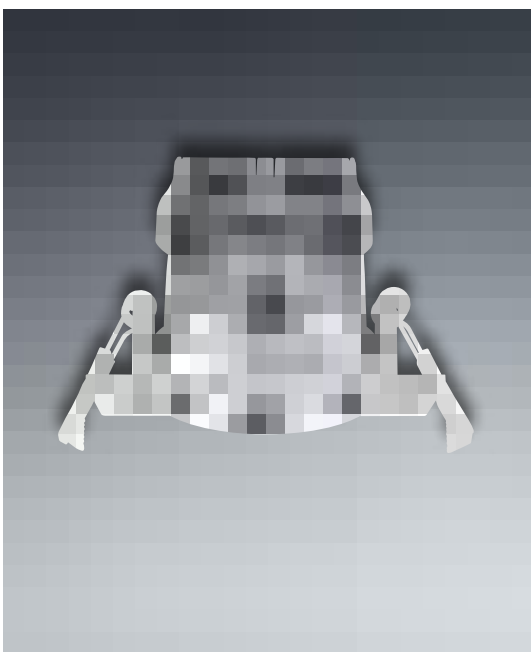
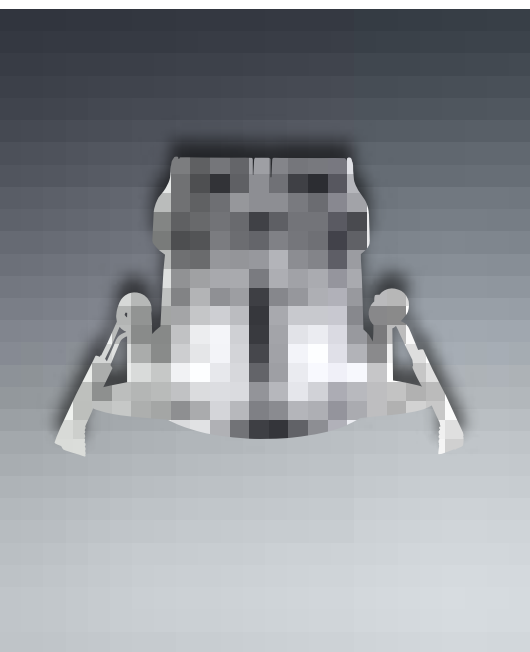

ZAGROS

Metall · metal ·
metale · metaal · metal · metallo · metal · metalli · metal ·



06



07



31



32

Einbauleuchte · Recessed light

↔ 8,5 x 8,5 cm, ↑ 5,4 cm
incl. 1 x SMD, 5,5 W
345 lm, 3.000 K



650610106 | Chrom · chrome
650610107 | Nickel matt · nickel mat
650610131 | Weiß matt · white mat
650610132 | Schwarz matt · black mat

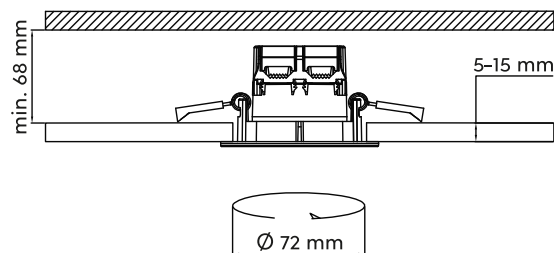

562



06



07



31



32

Einbauleuchte · Recessed light

Ø 8,5 cm, ↑ 5,4 cm
incl. 1 x SMD, 5,5 W
345 lm, 3.000 K



650710106 | Chrom · chrome
650710107 | Nickel matt · nickel mat
650710131 | Weiß matt · white mat
650710132 | Schwarz matt · black mat

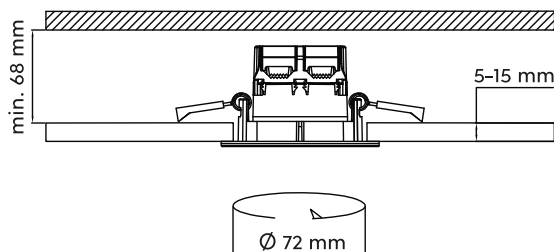

07



06

3er Set / Set 3

650610306 | Chrom · chrome
650610307 | Nickel matt · nickel mat
650610331 | Weiß matt · white mat

3er Set / Set 3

650710306 | Chrom · chrome
650710307 | Nickel matt · nickel mat
650710331 | Weiß matt · white mat

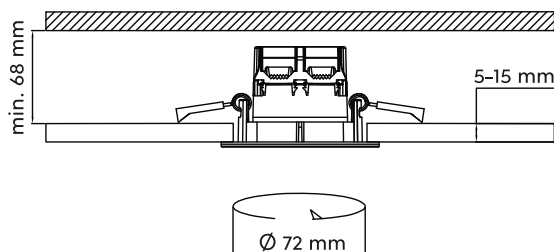

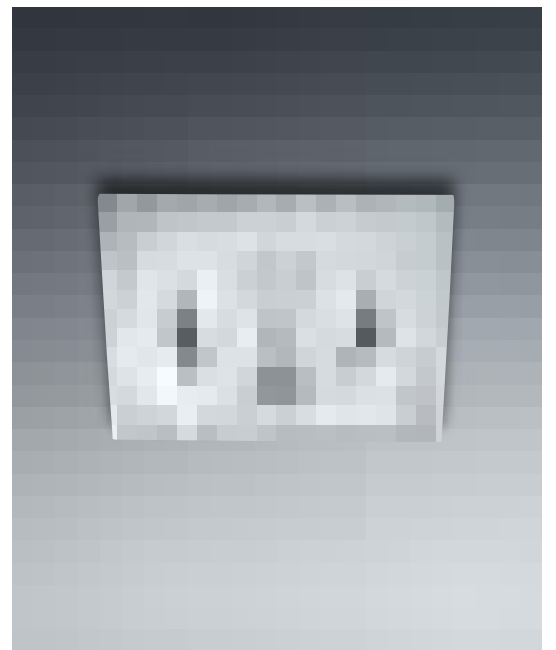
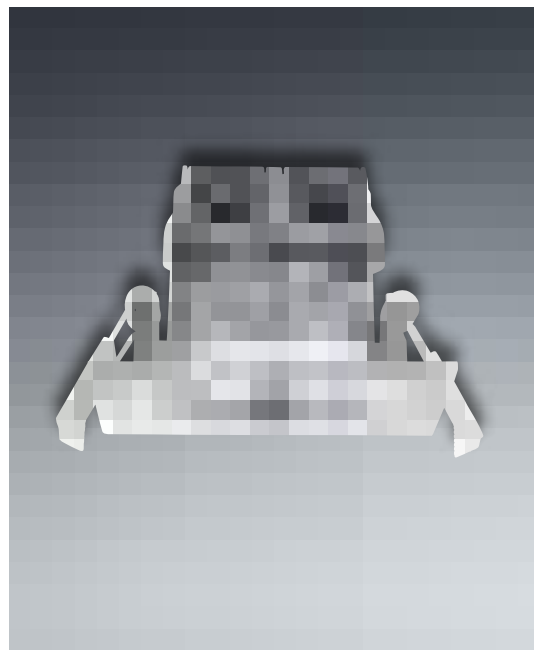
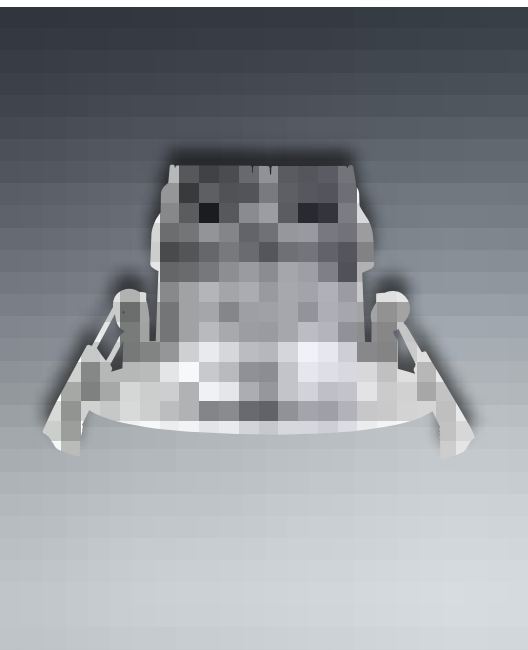

RILA

Metall · metal ·
metale · metaal · metal · metallo · metal · metalli · metal ·



06



07



31

Einbauleuchte · Recessed light
↔ 8 x 8 cm, ↑ 3,4 cm
incl. 1 x SMD, 5 W
450 lm, 3.000 K

650210106 | Chrom · chrome
650210107 | Nickel matt · nickel mat
650210131 | Weiß matt · white mat

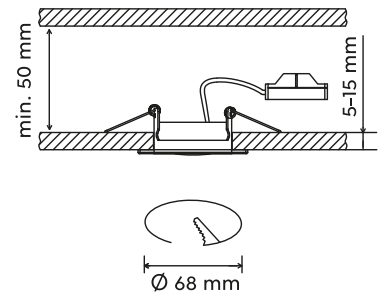

06



07



31

Einbauleuchte · Recessed light
Ø 8,2 cm, ↑ 3,4 cm
incl. 1 x SMD, 5 W
450 lm, 3.000 K

650310106 | Chrom · chrome
650310107 | Nickel matt · nickel mat
650310131 | Weiß matt · white mat

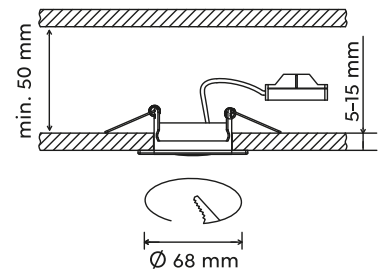

07



31

3er Set / Set 3

650210306 | Chrom · chrome
650210307 | Nickel matt · nickel mat
650210331 | Weiß matt · white mat

3er Set / Set 3

650310306 | Chrom · chrome
650310307 | Nickel matt · nickel mat
650310331 | Weiß matt · white mat

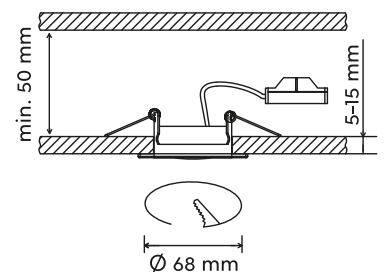

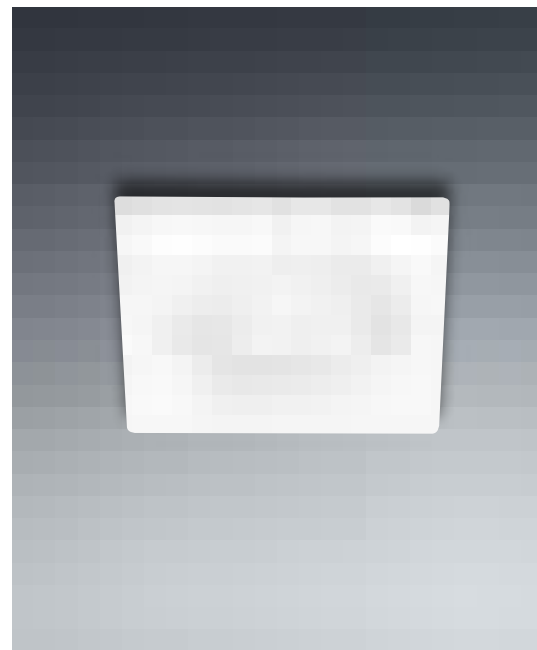
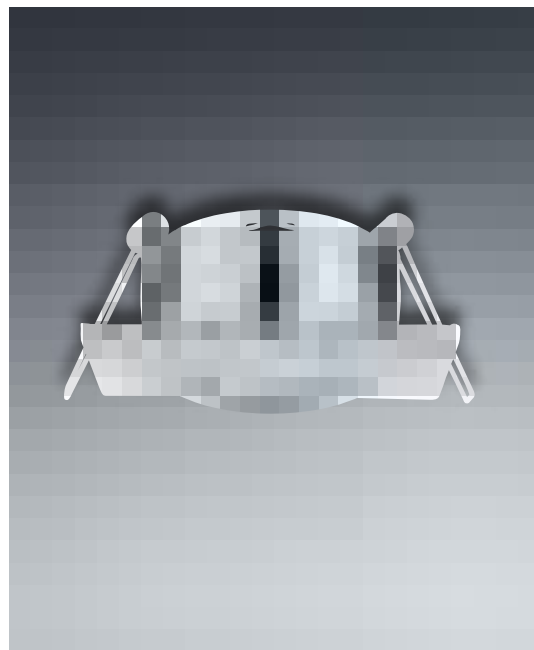
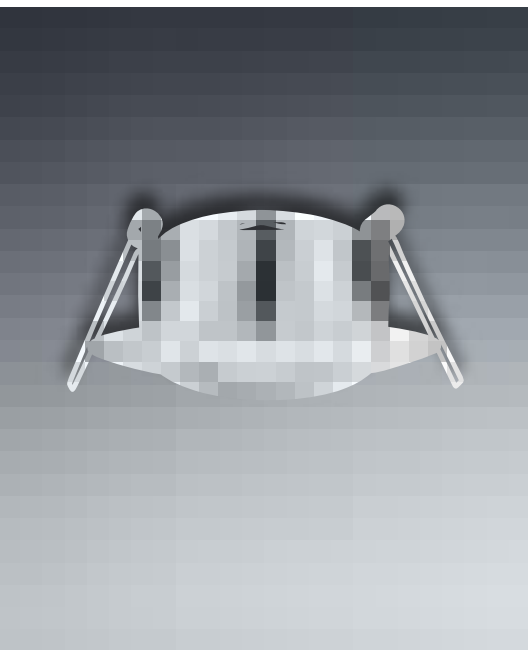

DOLOMITE

Kristallglas · crystal glass ·
verre cristal · kristal glas · vidrio cristal ·
vetro cristallo · sticla cristal · kristallilasi · szkło kryształ



Einbauleuchte · Recessed light
Ø 9 cm, ↑ 9,5 cm
excl. 1 x GU10, max. 10 W



651700152

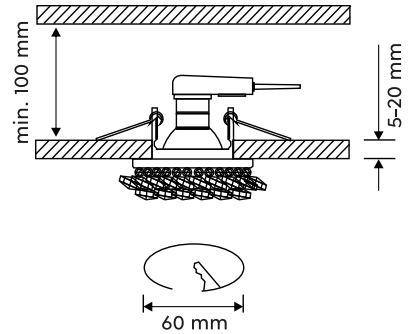

Einbauleuchte · Recessed light
↔ 10 x 10 cm, ↑ 9,5 cm
excl. 1 x GU10, max. 10 W



651800152

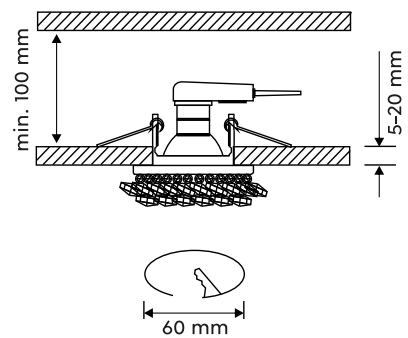

PIRIN

Kristallglas · crystal glass ·
verre cristal · kristal glas · vidrio cristal ·
vetro cristallo · sticla cristal · kristallilasi · szkło kryształ



Einbauleuchte · Recessed light
Ø 9 cm, ↑ 7 cm
excl. 1 x GU10, max. 10 W



652100152

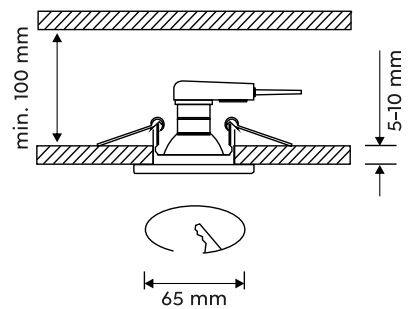

Einbauleuchte · Recessed light
↔ 9 x 9 cm, ↑ 7 cm
excl. 1 x GU10, max. 10 W



652200152

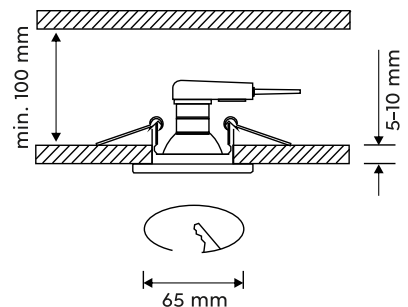

Empfohlen:
recommended: LED GU10, 3 W
250 lm, 3.000 K



956-30



JURA

Metall · metal ·
metale · metaal · metal · metallo · metal · metalli · metal ·



06



07



08



31



32

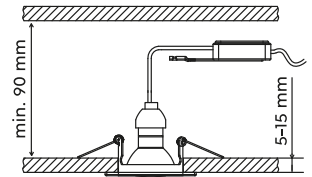

Einbauleuchte · Recessed light
↔ 8 x 8 cm, ↑ 7 cm
excl. 1 x GU10, max. 15 W



650000106 | Chrom · chrome
650000107 | Nickel matt · nickel mat
650000108 | Messing matt · brass mat
650000131 | Weiß matt · white mat
650000132 | Schwarz matt · black mat



06



07



08



31



32

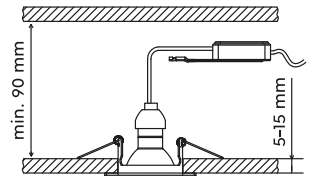

Einbauleuchte · Recessed light
Ø 8,3 cm, ↑ 7 cm
excl. 1 x GU10, max. 15 W



650100106 | Chrom · chrome
650100107 | Nickel matt · nickel mat
650100108 | Messing matt · brass mat
650100131 | Weiß matt · white mat
650100132 | Schwarz matt · black mat



31



07

3er Set / Set 3

650000306 | Chrom · chrome
650000307 | Nickel matt · nickel mat
650000331 | Weiß matt · white mat

3er Set / Set 3

650100306 | Chrom · chrome
650100307 | Nickel matt · nickel mat
650100331 | Weiß matt · white mat

Empfohlen:
recommended: LED GU10, 3 W
250 lm, 3.000 K



956-30



KENAI

Metall · metal ·
metale · metaal · metal · metallo · metal · metalli · metal ·



Empfohlen:
recommended: LED GU10, 4,5 W
345 lm, 3.000 K



956-55



31



32

Einbauleuchte · Recessed light
Ø 9,2 cm, ↑ 10 cm
excl. 1 x GU10, max. 15 W

651500131 | Weiß matt · white mat
651500132 | Schwarz matt · black mat

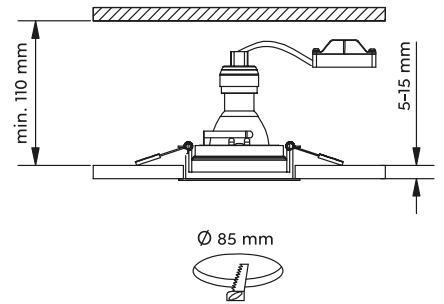

31



32

Einbauleuchte · Recessed light
↔ 9,2 x 9,2 cm, ↑ 10 cm
excl. 1 x GU10, max. 15 W

651600131 | Weiß matt · white mat
651600132 | Schwarz matt · black mat

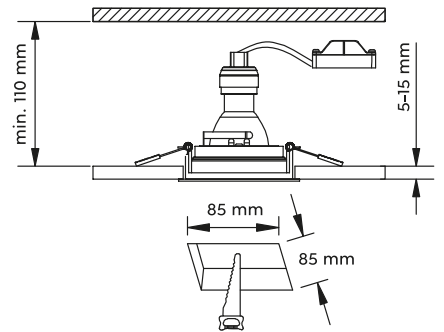

31



32

Einbauleuchte · Recessed light
↔ 17,2 x 9,2 cm, ↑ 10 cm
excl. 2 x GU10, max. 15 W

651600231 | Weiß matt · white mat
651600232 | Schwarz matt · black mat

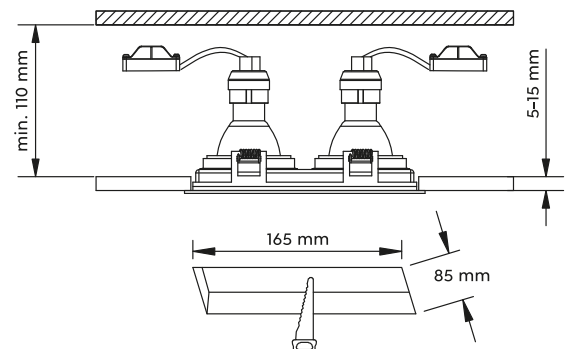



31



32

Einbauleuchte · Recessed light
 ↔ 25,2 x 9,2 cm, ↑ 10 cm
 excl. 3 x GU10, max. 15 W



651600331 | Weiß matt · white mat
 651600332 | Schwarz matt · black mat

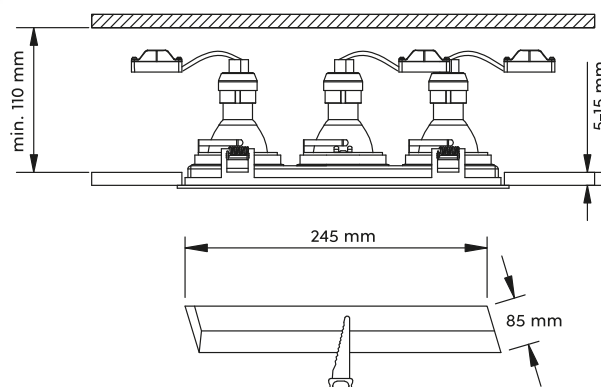





Badezimmerleuchten

Bathroom lighting

Éclairage salle de bains

Badkamer verlichting

Iluminación de cuarto de baño

Illuminazione per bagno

Iluminat baie

Kylpyhuone valaistus

Oświetlenie łazienkowe

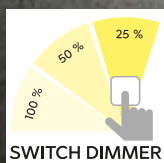

ASCARI

Metall, Chrom oder Schwarz matt · metal, chrome or black mat ·
 metale, chrome ou noir mat · metaal, chroom of mat zwart · metal, cromo o estera negra ·
 metallo, cromo o nero opaco · metal, crom sau negru mat · metalli, kromi tai mattamusta ·
 metal, chrom lub czarny mat

IP44



06 | Chrom · chrome



32 | Schwarz matt · black mat



Deckenleuchte · Ceiling lamp
 Ø 30 cm, ↓ 6,8 cm
 incl. SMD-LED, 28 W
 3.200 lm, 3.000 K



680810306
 680810332



Deckenleuchte · Ceiling lamp
 Ø 40 cm, ↓ 6,8 cm
 incl. SMD-LED, 35 W
 4.100 lm, 3.000 K



680819306
 680819332



GIANNI

Metall, Chrom oder Schwarz matt · metal, chrome or black mat ·
 metale, chrome ou noir mat · metaal, chroom of mat zwart · metal, cromo o estera negra ·
 metallo, cromo o nero opaco · metal, crom sau negru mat · metalli, kromi tai mattamusta ·
 metal, chrom lub czarny mat



IP44



Wandleuchte · Wall lamp
 ↔ 40 x 17,5 cm, ∇ 14,8 cm
 incl. SMD-LED, 17 W
 1.700 lm, 3.000 K



283770106
 283770132

Wandleuchte · Wall lamp
 ↔ 60 x 8 cm, ∇ 15 cm
 incl. SMD-LED, 22 W
 2.700 lm, 3.000 K



283779106
 283779132



06 | Chrom · chrome



32 | Schwarz matt · black mat



Deckenleuchte · Ceiling lamp
Ø 41,5 cm, ↑ 16,5 cm
incl. 5 x SMD-LED, 3,1 W
5 x 310 lm, 3.000 K

IP44



682410506



576

BOLSA

Chrom, Acryl · chrome, acryl ·
chrome, acryl · chroom, acryl · cromo, acrílico ·
cromo, acrílico · crom, acrilic · kromi, akryyli ·
chrom, akryl

IP44



Wandleuchte · Wall lamp
↑ 19 cm, ↔ 7 cm, √ 12 cm
incl. 1 x SMD-LED, 3,1 W
310 lm, 3.000 K

IP44



282410106



Wandleuchte · Wall lamp
↑ 30 cm, ↔ 7 cm, √ 12 cm
incl. 2 x SMD-LED, 3,1 W
2 x 310 lm, 3.000 K

IP44



282410206

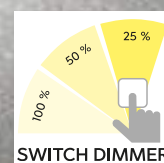

CINZIA

Chrom, Acryl mit Kristalleffekt · chrome, broken glass optic ·
 chrome, optique verre pilé · chroom, Gebroken glas optiek ·
 cromo, Efecto cristal roto · cromo, effetto ottico vetro rotto ·
 crom, aspect de sticla sparta · kromi, lasi efekti optiikka ·
 chrom, Optyczne rozbite szkło

IP44



Deckenleuchte · Ceiling lamp
 Ø 40 cm, ↑ 3 cm
 incl. SMD-LED, 22 W
 2.700 lm, 3.000 K



686412406



Deckenleuchte · Ceiling lamp
 ↔ 40 x 40 cm, ↑ 3 cm
 incl. SMD-LED, 22 W
 2.700 lm, 3.000 K



686512406



CLARIMO

Kunststoff · plastic ·
plastique · kunststof · plástico · plastica · plastic · muovi · plastik



IP44



01 | Weiß · white



32 | Schwarz matt · black mat



06 | Chrom · chrome



87 | titanfarbig · titanium-coloured

Deckenleuchte · Ceiling lamp
Ø 33 cm, ↓ 9 cm,
incl. SMD-LED, 18 W
1.850 lm, 3.000 K



659011801
659011806
659011832
659011887



RAY

Kunststoff, Chrom oder Schwarz matt · plastic, chrome or black mat ·
 plastique, chrome ou noir mat · kunststof, chroom of mat zwart ·
 plástico, cromo o estera negra · plastica, cromo o nero opaco ·
 plastic, crom sau negru mat · muovi, kromi tai mattamusta ·
 plastik, chrom lub czarny mat

IP44

06 | Chrom · chrome

32 | Schwarz matt · black mat



Wandleuchte · Wall lamp
 ↑ 8,3 x 5,2 cm, √ 8 cm
 incl. 1 x SMD-LED, 4 W
 340 lm, 3.000 K



283110106
 283110132



Wandleuchte · Wall lamp
 ↑ 16,6 x 5,2 cm, √ 8 cm
 incl. 2 x SMD-LED, 4 W
 2 x 340 lm, 3.000 K



283110206
 283110232



ROCCO

Metall, Chrom oder Schwarz matt · metal, chrome or black mat ·
 metale, chrome ou noir mat · metaal, chroom of mat zwart · metal, cromo o estera negra ·
 metallo, cromo o nero opaco · metal, crom sau negru mat · metalli, kromi tai mattamusta ·
 metal, chrom lub czarny mat



IP44



06 | Chrom · chrome



32 | Schwarz matt · black mat

Wandleuchte · Wall lamp
 ↔ 60 x 3,6 cm, ∇ 8 cm
 incl. SMD-LED, 8 W
 800 lm, 3.000 K



283916006
 283916032

Wandleuchte · Wall lamp
 ↔ 90 x 3,6 cm, ∇ 8 cm
 incl. SMD-LED, 13 W
 1.400 lm, 3.000 K



283919006
 283919032





FABIO



Metall, Chrom oder Schwarz matt · metal, chrome or black mat ·
 metale, chrome ou noir mat · metaal, chroom of mat zwart · metal, cromo o estera negra ·
 metallo, cromo o nero opaco · metal, crom sau negru mat · metalli, kromi tai mattamusta ·
 metal, chrom lub czarny mat

IP44



01 | Weiß · white



02 | Schwarz · black

Wandleuchte · Wall lamp
 ↔ 42,5 x 3,8 cm, ∠ 7,9 cm
 incl. SMD-LED, 6 W
 700 lm, 3.000 K



283814206
 283814232

Wandleuchte · Wall lamp
 ↔ 80 x 3,8 cm, ∠ 7,9 cm
 incl. SMD-LED, 12 W
 1.400 lm, 3.000 K



283817906
 283817932

Wandleuchte · Wall lamp
 ↔ 120 x 3,8 cm, ∠ 7,9 cm
 incl. SMD-LED, 20 W
 2.300 lm, 3.000 K



283811206
 283811232





Wandleuchte · Wall lamp
 ↔ 41,5 x 5,5 cm, ∅ 7 cm
 incl. SMD-LED, 8 W
 850 lm, 3.000 K



284074206
 284074232



Wandleuchte · Wall lamp
 ↔ 79 x 5,5 cm, ∅ 7 cm
 incl. SMD-LED, 16 W
 1.650 lm, 3.000 K



284077906
 284077932



Wandleuchte · Wall lamp
 ↔ 119 x 5,5 cm, ∅ 7 cm
 incl. SMD-LED, 21 W
 2.200 lm, 3.000 K



284071206
 284071232



PIERA

Kunststoff, Chrom oder Schwarz matt · plastic, chrome or black mat ·
 plastique, chrome ou noir mat · kunststof, chroom of mat zwart · plástico, cromo o estera negra ·
 plastica, cromo o nero opaco · plastic, crom sau negru mat · muovi, kromi tai mattamusta ·
 plastik, chrom lub czarny mat



IP44



06 | Chrom · chrome



32 | Schwarz matt · black mat

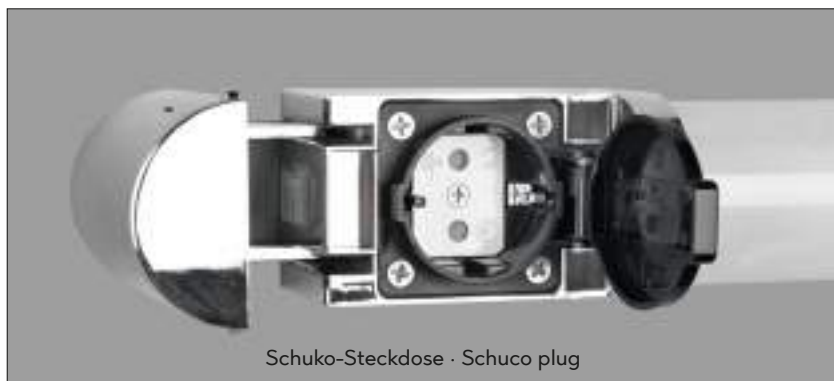



KOLIAN

Kunststoff, Chrom · plastic, chrome ·
 plastique, chrome · kunststof, chrom · plástico, cromo · plastica, cromo · plastic, crom · muovi, kromi · plastik, chrom



IP44



Steckdose · Plug



Schuko-Steckdose · Schuco plug



Wandleuchte · Wall lamp
 ↔ 44 x 6 cm, ↗ 9 cm
 incl. SMD-LED, 6 W
 700 lm, 3.000 K



281570606



Wandleuchte · Wall lamp
 ↔ 64 x 6 cm, ↗ 9 cm
 incl. SMD-LED, 9 W
 970 lm, 3.000 K



281570906





Wandleuchte · Wall lamp
 ↔ 40,4 x 5,5 cm, ↗ 8,5 cm
 incl. 1 x SMD-LED, 4,3 W
 450 lm, 3.000 K



283270106
 283270132



Wandleuchte · Wall lamp
 ↔ 60,4 x 5,5 cm, ↗ 8,8 cm
 incl. 1 x SMD-LED, 6,5 W
 680 lm, 3.000 K



283270206
 283270232



Wandleuchte · Wall lamp
 ↔ 80,4 x 5,5 cm, ↗ 8,8 cm
 incl. 1 x SMD-LED, 8,6 W
 880 lm, 3.000 K



283270306
 283270332



MATTIMO

Metall, Kunststoff, Chrom oder Schwarz matt · metal, plastic, chrome or black mat ·
 metale, plastique, chrome ou noir mat · metaal, kunststof, chroom of mat zwart · metal, plástico, cromo o estera negra ·
 metallo, plastica, cromo o nero opaco · metal, plastic, crom sau negru mat · metalli, muovi, kromi tai mattamusta ·
 metal, plastik, chrom lub czarny mat



IP44



06 | Chrom · chrome



32 | Schwarz matt · black mat





LINO



Kunststoff, Chrom oder Schwarz matt · plastic, chrome or black mat ·
 plastique, chrome ou noir mat · kunststof, chrom of mat zwart · plástico, cromo o estera negra ·
 plastica, cromo o nero opaco · plastic, crom sau negru mat · muovi, kromi tai mattamusta ·
 plastik, chrom lub czarny mat

IP44



06 | Chrom · chrome



32 | Schwarz matt · black mat



Wandleuchte · Wall lamp
 ↔ 40 x 6 cm, ∇ 10,5 cm
 incl. SMD-LED, 7,4 W
 900 lm, 3.000 K



284114006
 284114032



Wandleuchte · Wall lamp
 ↔ 60 x 6 cm, ∇ 10,5 cm
 incl. SMD-LED, 11 W
 1.350 lm, 3.000 K



284116006
 284116032





LORENZO

Metall, Chrom oder Schwarz matt · metal, chrome or black mat ·
 metale, chrome ou noir mat · metaal, chroom of mat zwart · metal, cromo o estera negra ·
 metallo, cromo o nero opaco · metal, crom sau negru mat · metalli, kromi tai mattamusta ·
 metal, chrom lub czarny mat

IP44

Empfohlen:
 recommended: LED GU10, 3 W
 250 lm, 3.000 K



956-30



06 | Chrom · chrome



32 | Schwarz matt · black mat

Strahler · Spot
 ↓ 5,4 x 3,3 cm, ↗ 10,1 cm
 excl. 1 x GU10, max. 5 W



283500106
 283500132



GIADA



Metall, Chrom oder Schwarz matt · metal, chrome or black mat ·
 metale, chrome ou noir mat · metaal, chroom of mat zwart · metal, cromo o estera negra ·
 metallo, cromo o nero opaco · metal, crom sau negru mat · metalli, kromi tai mattamusta ·
 metal, chrom lub czarny mat

IP44

Empfohlen:
 recommended: LED GU10, 3 W
 250 lm, 3.000 K



956-30



06 | Chrom · chrome



32 | Schwarz matt · black mat

Strahler · Spot
 ↓ 11,4 x 5,4 cm, ∠ 34,3 cm
 excl. 1 x GU10, max. 5 W



283400106
 283400132



Strahler · Spot
 Ø 10,5 cm cm, ↗ 15,5 cm
 excl. 1 x GU10, max. 5 W



880400106
880400132

Strahler · Spot
 Ø 20 cm, ↑ 15,5 cm
 excl. 3 x GU10, max. 5 W



880430306
880430332

Strahler · Spot
 ↔ 52 x 9,5 cm, ↑ 19,5 cm
 excl. 4 x GU10, max. 5 W



880400406
880400432



ANGELO



Metall, Chrom oder Schwarz matt · metal, chrome or black mat ·
 metale, chrome ou noir mat · metaal, chroom of mat zwart · metal, cromo o estera negra ·
 metallo, cromo o nero opaco · metal, crom sau negru mat · metalli, kromi tai mattamusta · metal, chrom lub czarny mat

IP44

Empfohlen:
 recommended: LED GU10, 3 W
 250 lm, 3.000 K



956-30

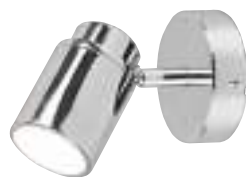

06 | Chrom · chrome



32 | Schwarz matt · black mat



VIEW

Chrom · chrome ·
chrome · chroom · cromo · cromo ·
crom · kromi · chrom

IP44



On/Off Touch Funktion ·
On/Off Touch function



Vergrößerung 3x ·
Magnification 3x



Wandleuchte · Wall lamp
Ø 21 cm, \sphericalangle max. 36 cm
incl. SMD-LED, 3 W
280 lm, 3.000 K



282990106



THEATRO

Chrom · chrome ·
chrome · chroom · cromo · cromo ·
crom · kromi · chrom

IP44

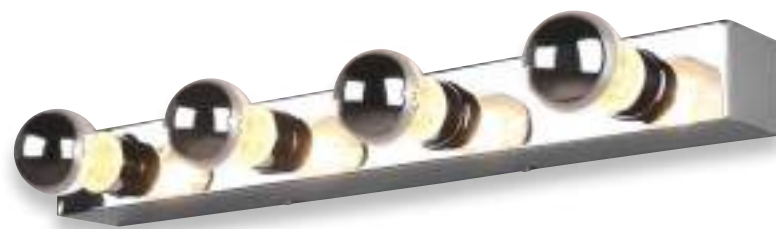

Empfohlen:
recommended: Filament LED E27, 4 W
420 lm, 2.800 K



987-410

H₂O

Wandleuchte · Wall lamp
↔ 55 x 8 cm, ∅ 6,5 cm
excl. 4 x E27, max. 28 W



283600406



ZENIA

Metall · metal ·
metale · metaal · metal · metallo · metal · metalli · metal

IP65

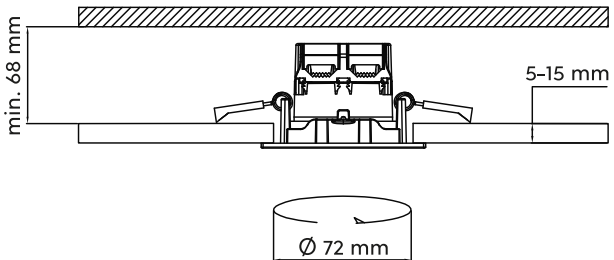

06 | Chrom · chrome



31 | Weiß matt · white mat



32 | Schwarz matt · black mat

Einbauleuchte · Recessed spot
Ø 8,5 cm, ↑ 5,4 cm
incl. SMD-LED, 5,5 W
345 lm, 3.000 K



680710106
680710131
680710132



CAMILLA

Kunststoff, Schwarz matt · plastic, black mat ·
 plastique, noir mat · kunststof, mat zwart · plástico, estera negra ·
 plastica, nero opaco · plastic, negru mat · muovi, mattamusta · plastik, czarny mat



IP44

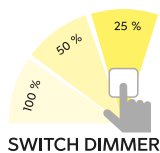

Deckenleuchte · Ceiling lamp
 Ø 40 cm, ↑ 3 cm
 incl. SMD-LED, 22 W
 2.700 lm, 3.000 K



689214032



Deckenleuchte · Ceiling lamp
 ↔ 40 x 40 cm, ↑ 3 cm
 incl. SMD-LED, 22 W
 2.700 lm, 3.000 K



689314032

PAOLO

Kunststoff, Weiß · plastic, white ·
 plastique, blanc · kunststof, wit · plástico, blanco ·
 plastica, bianco · plastic, alb · muovi, valkoinen · plastik, biały

IP44



Deckenleuchte · Ceiling lamp
 Ø 37 cm, ↑ 8,5 cm
 incl. SMD-LED, 15 W
 1.500 lm, 3.000 K



686014001



Deckenleuchte · Ceiling lamp
 Ø 37 cm, ↑ 8,5 cm
 incl. SMD-LED, 15 W
 1.500 lm, 4.000 K



686014000



FRODENO

Acryl · acryl ·
acryl · acryl · acrílico · acrílico · acrilic · akryyli · akryl

IP44



RGBW Farbwechsler ·
RGBW Colorchanging



Memory Funktion ·
Memory function



Starlight Effekt ·
Starlight effect



Deckenleuchte · Ceiling lamp

Ø 35 cm, ↑ 8,7 cm
incl. RGBW-LED, 12 W
1.200 lm, 4.000 K



680213500

Deckenleuchte · Ceiling lamp

Ø 48 cm, ↑ 10,2 cm
incl. RGBW-LED, 18,5 W
1.900 lm, 4.000 K



680214800



APART

Kunststoff, Chrom · plastic, chrome ·
 plastique, chrome · kunststof, chrom · plástico, cromo ·
 plastica, cromo · plastic, crom · muovi, kromi · plastik, chrom

IP44



Deckenleuchte · Ceiling lamp
 Ø 35 cm, ↑ 10 cm,
 incl. SMD-LED, 18 W
 1.850 lm, 3.000 K



659411806



Deckenleuchte · Ceiling lamp
 Ø 41 cm, ↑ 10 cm,
 incl. SMD-LED, 22 W
 2.500 lm, 3.000 K



659412406

UMBERTO

Kunststoff, Chrom oder Schwarz matt · plastic, chrome or black mat ·
 plastique, chrome ou noir mat · kunststof, chroom of mat zwart · plástico, cromo o estera negra ·
 plastica, cromo o nero opaco · plastic, crom sau negru mat · muovi, kromi tai mattamusta ·
 plastik, chrom lub czarny mat

IP44



06 | Chrom · chrome



32 | Schwarz matt · black mat



Deckenleuchte · Ceiling lamp
 Ø 29 cm, ↑ 8 cm
 incl. SMD-LED, 12 W
 1.160 lm, 3.000 K



680310106
680310132



Deckenleuchte · Ceiling lamp
 Ø 42 cm, ↑ 10 cm
 incl. SMD-LED, 18,5 W
 1.900 lm, 3.000 K



680319106
680319132





XAVI

Chrom, Glas matt · chrome, mat glass ·
 chrome, verre mat · chrom, mat glas · cromo, vidrio mate ·
 cromo, vetro sabbato · crom, sticla mata · kromi, mattalasi ·
 chrom, szkło matowane

IP21



Empfohlen:
 recommended: LED E14, 4,5 W
 470 lm, 2.700 K



989-400



Wandleuchte · Wall lamp
 ↔ 30,5 cm, ↑ 8,3 cm, ∟ 6,3 cm
 excl. 2 x E14, max. 40 W



2803021-06



Wandleuchte · Wall lamp
 ↔ 40,5 cm, ↑ 8,3 cm, ∟ 6,3 cm
 excl. 3 x E14, max. 40 W



2803031-06



CONDUS

Metall, Glas matt · metal, mat glass ·
 metale, verre mat · metaal, mat glas ·
 metal, vidrio mate · metallo, vetro sabbato ·
 metal, sticla mata · metalli, matalasi ·
 metal, szkło matowane

IP44

Empfohlen:
 recommended: LED E27, 4 W
 470 lm, 2.700 K



987-400



01 | Weiß · white



06 | Chrom · chrome



07 | Nickel matt · nickel mat



32 | Schwarz matt · black matt



Deckenleuchte · Ceiling lamp

Ø 31,5 cm, ↑ 8 cm
 excl. 1 x E27, max. 60 W



6801011-01
 6801011-06
 6801011-07
 6801011-32





Leuchtmittel

Light sources

Ampoules

Lichtbronnen

Fuentes de luz

Lampadine

Becuri

Valonlähteet

Źródła światła

LED-LEUCHTMITTEL E27

LED bulbs E27 · Ampoules LED E27 · LED-lampen E27 · Bombillas a LED E27 ·
Lampadine a LED E27 · Becuri cu LED-uri E27 · LED-Valonlähteet E27 · Żarówki LED E27

Code	Socket	Power	Lumen	Kelvin	Lifetime	Dimmable	Switch Dimmer	Switch Dim To Warm
------	--------	-------	-------	--------	----------	----------	---------------	--------------------

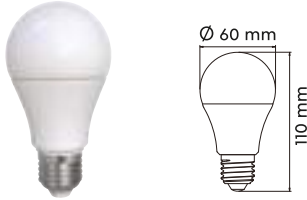

987-60	E27	4,9 W	470 lm	3.000 K	25.000 h			
988-700	E27	7 W	560 lm	3.000 K	25.000 h	✓		
988-10	E27	10 W	806 lm	3.000 K	25.000 h		✓	
988-110	E27	10 W	806 lm	3.000 K	25.000 h	✓		

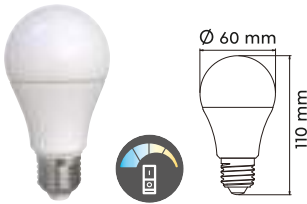

987-909	E27	9 W	806 lm	2.200 K	25.000 h			✓
				2.700 K				
				3.000 K				

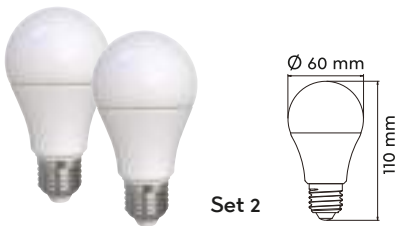

987-260	E27	4,9 W	470 lm	3.000 K	25.000 h			
---------	-----	-------	--------	---------	----------	--	--	--

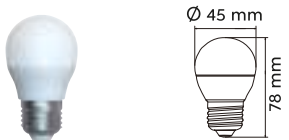

986-40	E27	4 W	320 lm	3.000 K	25.000 h			
986-60	E27	5 W	400 lm	3.000 K	25.000 h			



986-43	E27	4 W	320 lm	3.000 K	10.000 h			
986-63	E27	5 W	400 lm	3.000 K	10.000 h			

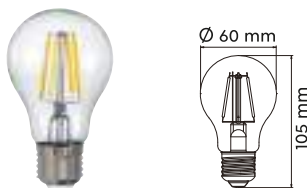

987-400	E27	4 W	470 lm	2.700 K	10.000 h			
987-6810	E27	7 W	806 lm	2.700 K	10.000 h		✓	

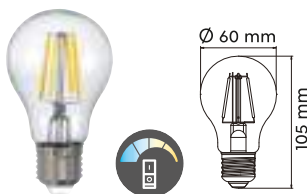

987-7009	E27	7 W	806 lm	2.200 K	10.000 h			✓
				2.700 K				
				3.000 K				



Set 2

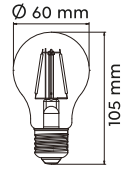

Code	Socket	Power	Lumen	Kelvin	Lifetime	Dimmable	Switch Dimmer	Switch Dim To Warm
987-2400	E27	4 W	470 lm	2.700 K	10.000 h			

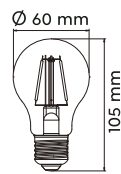

987-479 amber	E27	4 W	470 lm	2.700 K	10.000 h			
987-6700 amber	E27	8 W	700 lm	2.700 K	10.000 h		✓	

609



Set 2

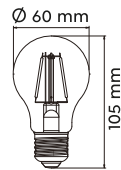

987-2479 amber	E27	4 W	470 lm	2.700 K	10.000 h			
----------------	-----	-----	--------	---------	----------	--	--	--

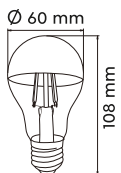

987-410 amber	E27	4 W	430 lm	2.800 K	10.000 h			
---------------	-----	-----	--------	---------	----------	--	--	--

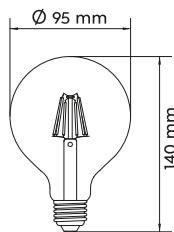

988-600	E27	7 W	806 lm	3.000 K	10.000 h			
---------	-----	-----	--------	---------	----------	--	--	--

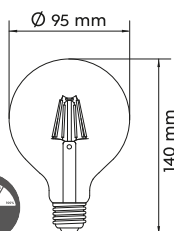

985-6810	E27	7 W	806 lm	2.700 K	10.000 h		✓	
----------	-----	-----	--------	---------	----------	--	---	--

LED-LEUCHTMITTEL E27

LED bulbs E27 · Ampoules LED E27 · LED-lampen E27 · Bombillas a LED E27 ·
Lampadine a LED E27 · Becuri cu LED-uri E27 · LED-Valonlähteet E27 · Żarówki LED E27

Code	Socket	Power	Lumen	Kelvin	Lifetime	Dimmable	Switch Dimmer	Switch Dim To Warm
------	--------	-------	-------	--------	----------	----------	---------------	--------------------

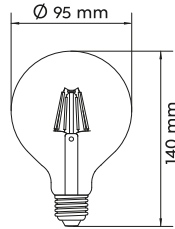

988-679	amber	E27	6 W	660 lm	2.700 K	10.000 h		
---------	-------	-----	-----	--------	---------	----------	--	--

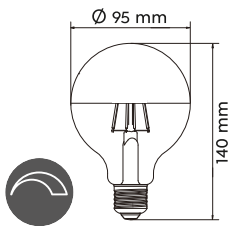

988-710		E27	7 W	680 lm	2.700 K	10.000 h	✓	
---------	--	-----	-----	--------	---------	----------	---	--

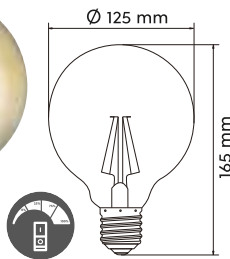

986-6810	clear	E27	8 W	810 lm	2.700 K	10.000 h		✓
986-6790	amber	E27	8 W	806 lm	2.700 K	10.000 h		✓

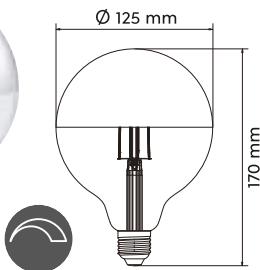

986-710		E27	7 W	680 lm	2.700 K	10.000 h	✓	
---------	--	-----	-----	--------	---------	----------	---	--

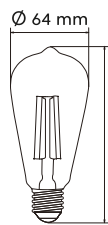

987-600	clear	E27	7 W	806 lm	3.000 K	10.000 h		
987-679	amber	E27	6 W	600 lm	2.700 K	10.000 h		

Code	Socket	Power	Lumen	Kelvin	Lifetime	Dimmable	Switch Dimmer	Switch Dim To Warm
------	--------	-------	-------	--------	----------	----------	---------------	--------------------

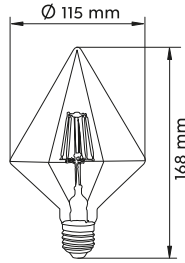

901-479	amber	E27	4 W	360 lm	2.700 K	25.000 h		
---------	-------	-----	-----	--------	---------	----------	--	--

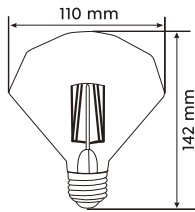

902-479	amber	E27	4 W	360 lm	2.700 K	25.000 h		
---------	-------	-----	-----	--------	---------	----------	--	--

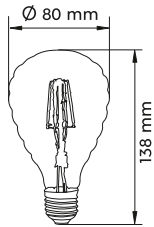

903-479	amber	E27	4 W	360 lm	2.700 K	25.000 h		
---------	-------	-----	-----	--------	---------	----------	--	--

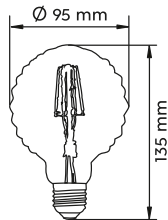

904-479	amber	E27	4 W	360 lm	2.700 K	25.000 h		
---------	-------	-----	-----	--------	---------	----------	--	--

LED-LEUCHTMITTEL E14

LED bulbs E14 · Ampoules LED E14 · LED-lampen E14 · Bombillas a LED E14 ·
Lampadine a LED E14 · Becuri cu LED-uri E14 · LED-Valonlähteet E14 · Żarówki LED E14

Code	Socket	Power	Lumen	Kelvin	Lifetime	Dimmable	Switch Dimmer	Switch Dim To Warm
------	--------	-------	-------	--------	----------	----------	---------------	--------------------

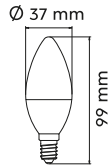

989-40	E14	3,5 W	320 lm	3.000 K	25.000 h			
989-56	E14	5 W	400 lm	3.000 K	25.000 h	✓		
989-60	E14	5 W	400 lm	3.000 K	25.000 h			
989-66	E14	6 W	470 lm	3.000 K	25.000 h		✓	

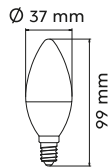

989-509	E14	5,5 W	400 lm	2.200 K	25.000 h			✓
				2.700 K				
				3.000 K				



Set 3

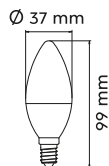

989-43	E14	4 W	320 lm	3.000 K	25.000 h			
989-63	E14	6 W	470 lm	3.000 K	25.000 h			

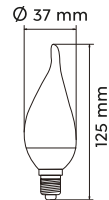

990-40	E14	4 W	320 lm	3.000 K	25.000 h			
--------	-----	-----	--------	---------	----------	--	--	--

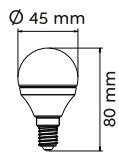

983-40	E14	3,5 W	320 lm	3.000 K	25.000 h			
983-56	E14	4,9 W	470 lm	3.000 K	25.000 h	✓		
983-60	E14	4,9 W	470 lm	3.000 K	25.000 h			
983-66	E14	4,9 W	470 lm	3.000 K	25.000 h		✓	

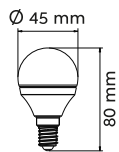

983-509	E14	5,5 W	400 lm	2.200 K	25.000 h			✓
				2.700 K				
				3.000 K				



Set 3

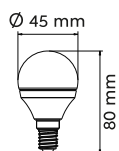

983-43	E14	3,5 W	320 lm	3.000 K	25.000 h			
983-63	E14	4,9 W	470 lm	3.000 K	25.000 h			

Code	Socket	Power	Lumen	Kelvin	Lifetime	Dimmable	Switch Dimmer	Switch Dim To Warm
------	--------	-------	-------	--------	----------	----------	---------------	--------------------

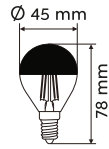

983-410	E14	4 W	420 lm	3.000 K	10.000 h			
---------	-----	-----	--------	---------	----------	--	--	--

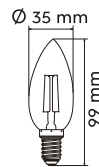

989-200	clear	E14	2 W	250 lm	2.700 K	10.000 h		
989-279	amber	E14	2 W	225 lm	2.700 K	10.000 h		
989-400	clear	E14	4 W	470 lm	2.700 K	10.000 h		
989-479	amber	E14	4 W	400 lm	2.700 K	10.000 h		

613

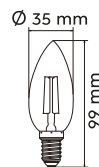

989-4470	clear	E14	4 W	470 lm	2.700 K	10.000 h		✓
989-4790	amber	E14	4 W	400 lm	2.700 K	10.000 h		✓



Set 3

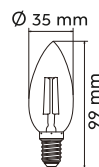

989-3200	clear	E14	2 W	250 lm	2.700 K	10.000 h		
989-3279	amber	E14	2 W	225 lm	2.700 K	10.000 h		
989-3400	clear	E14	4 W	470 lm	2.700 K	10.000 h		



990-200	clear	E14	2 W	250 lm	2.700 K	10.000 h		
990-279	amber	E14	2 W	225 lm	2.700 K	10.000 h		
990-400	clear	E14	4 W	470 lm	3.000 K	10.000 h		

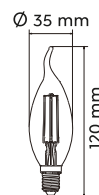

990-4470	clear	E14	4 W	470 lm	2.700 K	10.000 h		✓
990-4790	amber	E14	4 W	400 lm	2.700 K	10.000 h		✓

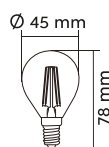

983-200	clear	E14	2 W	250 lm	2.700 K	10.000 h		
983-279	amber	E14	2 W	225 lm	2.700 K	10.000 h		
983-400	clear	E14	4 W	470 lm	2.700 K	10.000 h		
983-479	amber	E14	4 W	430 lm	2.700 K	10.000 h		

LED-LEUCHTMITTEL E14

LED bulbs E14 · Ampoules LED E14 · LED-lampen E14 · Bombillas a LED E14 ·
Lampadine a LED E14 · Becuri cu LED-uri E14 · LED-Valonlähteet E14 · Żarówki LED E14

Code	Socket	Power	Lumen	Kelvin	Lifetime	Dimmable	Switch Dimmer	Switch Dim To Warm
------	--------	-------	-------	--------	----------	----------	---------------	--------------------



983-4470	clear	E14	4,5 W	470 lm	2.700 K	10.000 h		✓
983-4790	amber	E14	4 W	400 lm	2.700 K	10.000 h		✓



983-3200	clear	E14	2 W	250 lm	2.700 K	10.000 h		
983-3279	amber	E14	2 W	225 lm	2.700 K	10.000 h		
983-3400	clear	E14	4 W	470 lm	2.700 K	10.000 h		

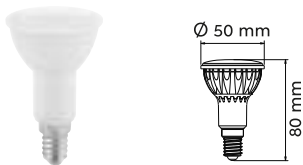

955-55	↘ 110°	E14	5 W	400 lm	3.000 K	25.000 h		
--------	--------	-----	-----	--------	---------	----------	--	--

LED-LEUCHTMITTEL G9

LED bulbs G9 · Ampoules LED G9 · LED-lampen G9 · Bombillas a LED G9 ·
Lampadine a LED G9 · Becuri cu LED-uri G9 · LED-Valonlähteet G9 · Żarówki LED G9

Code	Socket	Power	Lumen	Kelvin	Lifetime	Dimmable	Switch Dimmer	Switch Dim To Warm
------	--------	-------	-------	--------	----------	----------	---------------	--------------------



929-220	G9	2,3 W	200 lm	3.000 K	25.000 h			
---------	----	-------	--------	---------	----------	--	--	--



929-2300	G9	3 W	300 lm	3.000 K	25.000 h	✓		
----------	----	-----	--------	---------	----------	---	--	--



929-230	G9	3 W	300 lm	3.000 K	25.000 h		✓	
---------	----	-----	--------	---------	----------	--	---	--

LED-LEUCHTMITTEL GU10

LED bulbs GU10 · Ampoules LED GU10 · LED-lampen GU10 · Bombillas a LED GU10 · Lampadine a LED GU10 · Becuri cu LED-uri GU10 · LED-Valonlähdeet GU10 · Żarówki LED GU10

Code	Socket	Power	Lumen	Kelvin	Lifetime	Dimmable	Switch Dimmer	Switch Dim To Warm
956-30	GU10	3 W	250 lm	3.000 K	20.000 h			
956-330	GU10	3 W	250 lm	3.000 K	15.000 h			
955-50	GU10	5 W	400 lm	3.000 K	25.000 h			
956-5936	GU10	5 W	400 lm	3.000 K	20.000 h	✓		
956-5736	GU10	4,5 W	345 lm	3.000 K	20.000 h		✓	
956-55	GU10	4,5 W	345 lm	3.000 K	25.000 h		✓	
956-355	GU10	4,5 W	345 lm	3.000 K	25.000 h		✓	
956-509	GU10	5 W	345 lm	2.200 K 2.700 K 3.000 K	25.000 h			✓

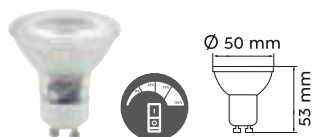

POS-LÖSUNGEN

POS solutions · Solutions de POS · POS-oplossingen ·
Soluciones POS · Soluzioni POS · Soluții POS · POS-ratkaisut · Rozwiązania POS

Leuchtmittel · Light sources



Tego-Regale
Tego shelves

↔ 1000 x 630 mm
↓ 2420/2675 mm



Topper PT 0011 XX
↔ 800 mm, ↓ 400 mm



Topper PT 0012 XX
↔ 800 mm, ↓ 400 mm



Topper PT 0013 CC
↔ 800 mm, ↓ 400 mm



Topper PT 0014 XX
↔ 800 mm, ↓ 400 mm



Display **RK51**
↔ 800 x 400 mm
↓ 1300 mm
Topper
↔ 800 mm, ↓ 400 mm



Display **RK78**
↔ 800 x 400 mm
↓ 1400 mm
Topper **PT0013**
↔ 800 mm, ↓ 400 mm



Display **PP005**
↔ 800 x 400 mm
↓ 1300 mm
Topper **PT0030**
↔ 600 mm, ↓ 350 mm

POS-LÖSUNGEN

POS solutions · Solutions de POS · POS-oplossingen ·
Soluciones POS · Soluzioni POS · Soluții POS · POS-ratkaisut · Rozwiązania POS



Individuell planbar ·
individually plannable



Tego-Regale
Tego shelves

↔ 1000/1250 mm
↑ 2400/2600 mm



619

Display **DUO01**
↔ 1200 x 800 mm
↓ 2480 mm

POS-LÖSUNGEN

POS solutions · Solutions de POS · POS-oplossingen ·
Soluciones POS · Soluzioni POS · Soluții POS · POS-ratkaisut · Rozwiązania POS

Badezimmerleuchten · Bathroom lighting



Tego-Regale
Tego shelves

↔ 1000/1250 mm
↑ 2420/2675 mm



Display **RK99**
↔ 1200 x 800 mm
↓ 2479 mm

POS-LÖSUNGEN

POS solutions · Solutions de POS · POS-oplossingen ·
Soluciones POS · Soluzioni POS · Soluții POS · POS-ratkaisut · Rozwiązania POS

622



Sticker
POST1033

Sticker
POST1034

Unterbauleuchten ·
Cabinet lights

Tego-Regale
Tego shelves

↔ 1000/1250 mm
↑ 2420/2675 mm

Einbauleuchten · Recessed lights

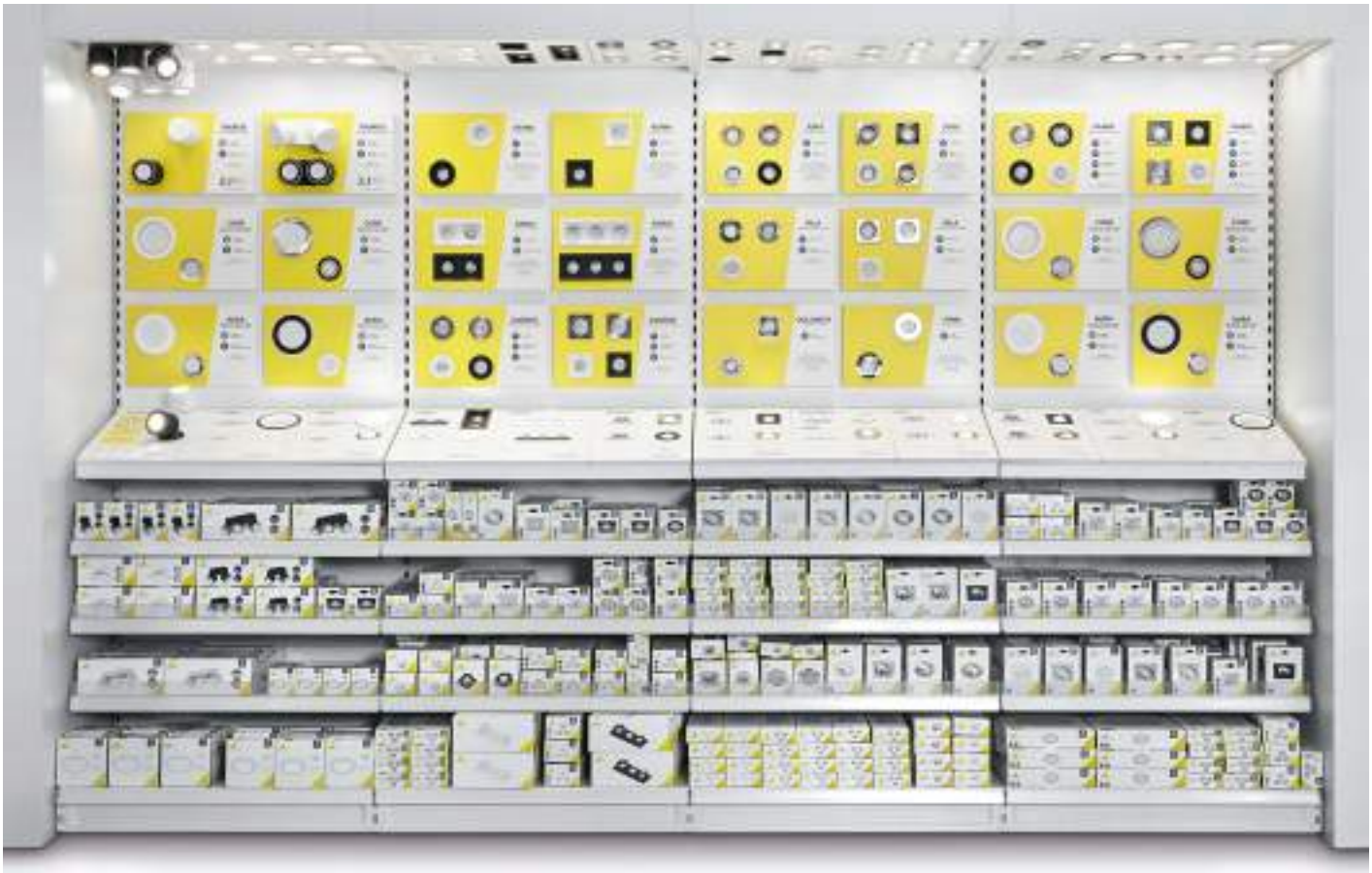

623

Tego-Regale
Tego shelves

↔ 1000/1250 mm
↓ 2400/2600 mm



Display **RK63**
↔ 1200 x 800 mm
↓ 2100 mm

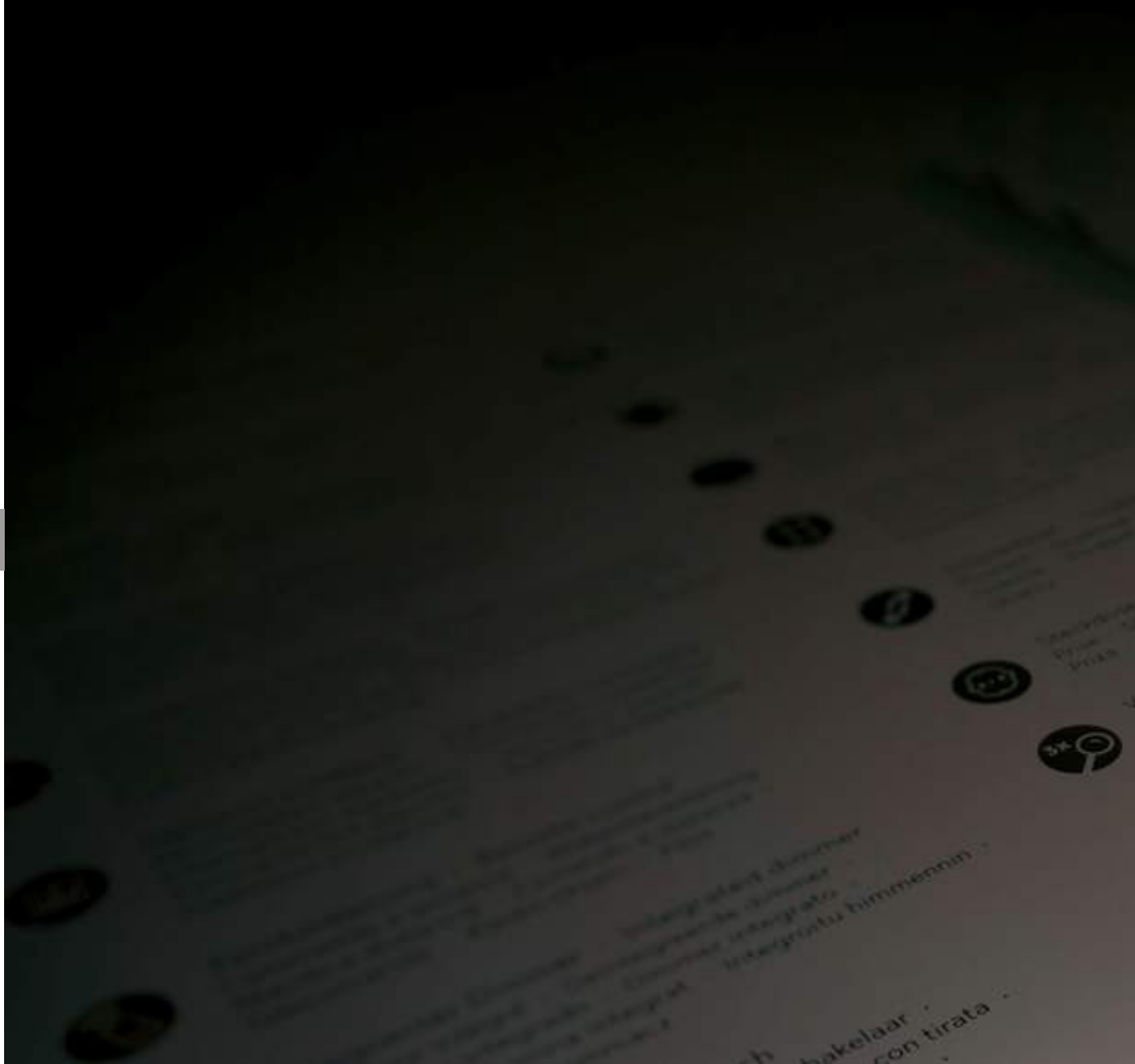



Spezifikationen

Specifications
Spécifications
Specifikaties
Especificaciones
Specifiche
Specificații
Tekniset tiedot
Specyfikacje

FARBEN & MATERIALIEN

Colours and materials · Couleurs et matériaux · Kleuren en materialen · Colores y materiales ·
Colori e materiali · Colori si materiale · Värit ja materiaalit · Kolory i materiały · Renkler ve malzemeler

- 00** Transparent · transparent
transparent · transparant · transparente · transparente ·
transparent · kirkas · przezroczysty · şeffaf
- 01** Weiß · white
blanc · wit · blanco · bianco · alb · valkoinen · biały · beyaz
- 02** Schwarz · black
noir · zwart · negro · nero · negru · musta · czarny · siyah
- 03** Messing poliert · polished brass
laiton polis · gepolijst messing · bronze · ottone lucido ·
bronz · messinki · mosiądz polerowany · piring
- 04** Altmessing · old brass
laiton fumé · oud brons · bronze viejo · ottone invecchiato ·
bronz antic · antiikkimessinki · patyna · antik piring
- 05** Aluminium gebürstet · brushed aluminium
aluminium balayé · geborsteld aluminium · aluminio pulido ·
alluminio spazzolato · aluminiu lucios · harjattu alumiini ·
aluminium szczotkowane · alüminyum
- 06** Chrom · chrome
chrome · chroom · cromo · cromo · crom ·
kromi · chrom · krom
- 07** Nickel matt · nickel mat
nickel mat · nikkellat · níquel mate · nichel opaco ·
nichel mat · harjattu teräs · nikiel mat · mat nikel
- 08** Messing matt · brass mat
laiton mat · messing mat · bronze mate · ottone satinato ·
bronz mat · mattamessinki · mosiądz mat · mat piring
- 09** kupferfarbig · copper
cuivré · koperkleurig · color cobre · colore rame · cupru ·
kuperinvärinen · kolorze miedzi · bakır renkli
- 10** Rot · red
rouge · rood · rojo · rosso · rosu ·
punainen · czerwony · kırmızı
- 11** Grau · grey
gris · grijs · gris · grigio · gri · harmaa · popielaty · gri
- 12** Blau · blue
bleu · blauw · azul · azzurro · gri · sininen · niebieski · mavi
- 13** Amber · amber
ambre · amber · ámbar · ambra · amber · meripihka ·
bursztynowy · amber
- 14** Braun · brown
brun · bruin · marron · marrone · maro · ruskea ·
brązowy · kahverengi
- 15** Grün · green
vert · groen · verde · verde · verde · vihreä · zielony · yeşil
- 16** Gelb · yellow
jaune · geel · amarillo · giallo · galben ·
keltainen · żółty · sarı
- 17** mehrfarbig · multicolor
multicolore · multicolor · multicolor · multicolore ·
multicolor · monivärinen · multi-kolor · çok renkli
- 18** Orange · orange
orange · oranje · naranja · arancione · portocaliu ·
oranssi · pomarańczowy · turuncu
- 19** Türkis · turquoise
turquoise · turquoise · turquesa · turchese · turcoaz ·
turkoosi · turkusowy · turkuvaz
- 24** rostfarbig · rusty
rouille · roestkleur · óxido · ruggine · ruginiu · rustiikki ·
miedz · pas
- 26** Braun · brown
brun · bruin · marron · marrone · maro · ruskea ·
brązowy · kahverengi
- 27** Weiß antik · antique white
blanc antique · antiek wit · blanco decapé · bianco anticato ·
alb antic · antiikkivalkoinen · antyczny biały · antik beyaz
- 28** rostfarbig antik · antique rust
rouille antique · roestkleur antiek · oxido · ruggine anticato ·
ruginiu antic · rustiikki · antyczny rdzawy · antik pas rengi
- 29** Kupfer matt · copper mat
cuivre mat · koper mat · estera de cobre · rame opaco ·
cupru mat · kupari mat · miedz mat · bakır mat
- 30** holzfarbig · wood coloured
couleur bois · houtkleur · color maderá · colore di legno ·
culoare lemn · puunvärinen · kolor drewna · ahşap renk
- 31** Weiß matt · white mat
blanc mat · wit mat · estera blanca · bianco opaco · alb mat ·
valkoinen matto · biały mat · beyaz mat
- 32** Schwarz matt · black mat
noir mat · mat zwart · estera negra · nero opaco ·
negru mat · musta matto · czarny mat · siyah mat
- 41** Taupe · taupe
taupe · taupe · gris pardo · taupe · taupe ·
ruskeanharmaa · ciemnoszary · taupe
- 42** Anthrazit · anthracite
antracite · antraciet · antracita · antracite · antracit ·
antrasiitti · antracyt · antrasit
- 45** Pastellblau · pastel blue ·
bleu pastel · pastel blauw · azul pastel · azzurro pastello ·
albastru pastel · pastellinsininen · pastelowy niebieski ·
pastel mavi
- 51** Apfelgrün · applegreen
vert pomme · appelgroen · verde manzana · verde mela ·
verde mar · omenanvihreä · zielone jabłko · elma yeşili
- 52** Transparent klar · transparent clear
transparente claire · transparant helder · transparente claro ·
transparente chiaro · transparent clar · kirkas ·
przezroczysty · şeffaf

- 54** rauchfarbig · smoke
fumé · rookkleur · humo · fume' · fumuriu ·
savu · przydymiony · duman
- 56** Holz dunkel · old wood
vieux bois · oud hout · madera envejecida · legno antico ·
old wood (Lemn vechi) · vanha puu · stare drewno
- 61** Grau antik · antique grey
gris ancien · antiek grijs · gris antiguo · grigio antico ·
antic gri · antiikki harmaa · starodawny szary · antika gri
- 62** Kupfer antik · antique copper
cuivre ancien · antiek koper · cobre antiguo · rame antico ·
cupru antic · antiikki kupari · antyczne miedzi · antik bakır
- 64** Bronze · bronze
bronze · bronze · bronce · bronzo · bronz ·
pronssi · brąz · tunç
- 67** Nickel antik · nickel antique
nickel antique · antiek nikkell · níquel antiguo · nickel anticato ·
nichel antic · antiikkiteräs · aikiel antyczny · antik nikel
- 78** betonfarbig · concrete look
couleur beton · beton kleur · color concreto ·
calcestruzzo · culoare beton · konkreettisia väri ·
konkretny kolor · beton rengi
- 79** goldfarbig · gold
or · goud · oro · oro · aur · kultaa · złota · altın
- 80** Schwarz-Gold · black-gold
noir et or · zwart-goud · negro-oro · oro nero ·
negru-auriu · musta-kulta · czarno złoty
- 87** titanfarbig · titan
titane · titaan · titán · titano · titaniu ·
titaani · tytanowy · titan
- 88** Silber antik · antique silver
argent antique · antiek zilver · plateado antiquo ·
argento anticato · argint antic · antiikkihopea ·
antyczne srebro · gümüş antika
- 89** silberfarbig · silver
argent · zilver · plata · argento · argint ·
hopea · srebrny · gümüş
- 91** Lila · lilac
lilla · lilla · lila · lilla · lila · lila · liliowy · leylak
- 92** Purpurrot · purple
pourpre · paars · púrpura · porpora · purpuriu ·
purppura · purpurowy · mor
- 93** Pink · pink
rose · pink · rosa · rosa · roz · pinkki · różowy · pembe
- 94** Pastellrosa · pastel pink ·
rose pastel · pastel rose · rosa pastel · rosa pastello ·
roz pastel · pastellin pinkki · pastelowy róż · pastel pembe

PRODUKTEIGENSCHAFTEN

Features · Caractéristiques · Kenmerken · Acabados ·
Caratteristiche · Caracteristici · Ominaisuudet · Cechy



Schalter · Switch

Interrupteur · Schakelaar · Interruptor ·
Interruttore · Intrerupator · Kytkin ·
Przełącznik



Fußschalter · Footswitch

interrupteur à pédale · Voetschakelaar ·
Interruptor de pie · interruttore a pedale ·
comutator picior · Päälle / pois jalkakytin ·
wyłącznik nożny



Schnurschalter · Cable switch

Interrupteur de cordon · Snoerschakelaar ·
Cable de interruptor · Interruttore su cavo ·
Intrerupator cu cablu · katkaisin ja johto ·
Przełącznik na kablu



On/Off Touch Funktion · On/Off Touch function

Interrupteur tactile On/Off · Touch schakelaar On/Off ·
Función táctil On/Off · Interruttore touch On/Off ·
Intrerupator tactil On/Off · Kosketuskäyttöinen On/Off ·
Funkcja dotykowa On/Off



Getrennt schaltbar · Separately switchable

Interrupteurs séparés · Gescheiden schakelbaar ·
Interruptores separados · Interruttori separati ·
Intrerupatoare separate · Erikseen kytkettävissä ·
Oddzileny przełącznik



Fernbedienung · Remote control

Commande à distance · Afstandsbediening ·
Mando a distancia · Comando a distanza ·
Telecomanda · Kauko-ohjain · Pilot



Integrierter Dimmer · Integrated dimmer

Variateur intégré · Geïntegreerde dimmer ·
Regulador integrado · Dimmer integrato ·
Variator de lumina integrat · Integroitu himmennin ·
Wbudowany ściemniacz



Zugschalter · Pull switch

Interrupteur de trait · Trekschakelaar ·
Interruptor de tiro · Interruttore con tirata ·
Interupator de tragere · Vetokytin ·
Przełącznik pociągany



Sensordimmer · Sensor dimmer

Variateur tactile · Touchdimmer ·
Regulador con sensor · Touchdimmer ·
Variator cu senzor · Kosketushimmennin ·
Czujnik ściemniania



Extern dimmbar · Externally dimmable

Dimmable avec variateur externe · Extern dimbaar ·
Dimmable por regulador externo · Dimmerabile con dimmer
esterno · variator extern de lumina · himmennettävissä ·
Zewnętrznie ściemniana



RGB Farbwechsler · RGB Colorchanging

Changement de couleur RGB · RGB Kleurverandering ·
Cambio de color RGB · Cambia colore RGB ·
Schimbator de culoare RGB · Värinvaihto RGB ·
Zmieniający kolor RGB



Lichtfarbe einstellbar · Adjustable light color

Couleur de lumière réglable · Lichtkleur instelbaar ·
Color de luz regulable · Colore della luce regolabile ·
Lumina colorata reglabila · Värilämpötila säädettävissä ·
Regulowana barwa światła



Höhenverstellbar · Adjustable height

Hauteur réglable · In hoogte verstelbaar ·
Altura regulable · Altezza regolabile ·
Inaltime reglabila · Säädettävä korkeus ·
Regulowana wysokość



Schwenkbar · Tiltable

Pivotant · Draaibaar · Pivotante ·
Girevole · Pivotant · Suunnattava ·
Skrętny



Steckdose · Plug

Prise · Stekker · Enchufe · Spina ·
Priza · Katkaisin · Gniazdko



Vergößerung 3x · Magnification 3x

Magnification 3x · Vergroting 3x · Aumentos 3x ·
Ingrandimento 3x · Suplimentare 3x · Suurentava 3x ·
Powiększenie 3x



4 fach TOUCH · 4 level Touch function

Interrupteur tactile 4 niveaux · Touch schakelaar 4 niveaus ·
Función Táctil 4 nivel · Interruttore touch 4 livelli ·
Intrerupator tactil 4 nivele · Kosketuskäyttöinen 4 taso ·
Funkcja dotykowa 4 poziomy



Flexibel · Flexible

Flexible · Flexibel · Flexible · Flessibile ·
Flexibil · Joustava · Elastyczne



Kippbar · Tilttable
Inclinable · Kantelbaar · Basculante ·
Inclinabile · Basculant · Kallistettava ·
Uchylny



Lichtfarbe stufenlos einstellbar ·
Light color infinitely variable
Couleur de lumière infiniment variable · Lichtkleur
traploos instelbaar · Color de luz infinitamente variable ·
Colore della luce infinitamente variabile · Culoare lumină
infiniit variabilă · Valon väri portaattomasti · Jasny kolor
bezstopniowo



USB Anschluss · USB connection
Entrée USB · USB aansluiting · Conexión USB ·
Connessione USB · Conexiune USB · USB-liitäntä ·
Połączenie USB



USB Anschluss mit Ladefunktion ·
Recharging USB connection
Entrée USB de rechargement · Opladende USB
aansluiting · Conexión USB de recarga · Connessione
USB di ricarica · Conexiune USB reîncărcare ·
Lataaminen USB-liitäntä · ładowania USB połączenie



Nachtlicht · Night light
Veilleuse de nuit · Nachtlicht · Luz de la noche ·
Luce notturna · Lampă de noapte · Yyövalo ·
Lampka nocna



Gestensteuerung · Gesture control
Contrôle gestuel · Gebarenbediening · Control gestual ·
Controllo gestuale · Control prin gesturi/mișcarea mâinii ·
Kädellä ohjattava liiketunnistin · Sterowana gestami



Up and down Beleuchtung · Up and Down lighting
Point lumineux en haut et en bas · Lichtpunt boven en
onder · Luz de arriba y abajo · Luce su e giù · Sus și în
jos lumina · Ylös ja alas valoa · W górę iw dół światło



Dimmbar mit Schalter · Dimmable via switch
Réglable avec interrupteur · Dimbaar via schakelaar ·
Regulable mediante interruptor · Dimmerabile tramite
interruttore · Estompat prin comutator · Himmennettävä
kytkimen · Ściemnialne za pośrednictwem przełącznika



Musterschutz · Registered model
Modèle déposé · Beschermd model ·
Modelo certificado · Modello depositato ·
Înregistrați model · Rekisteröity malli ·
Zarejestrowany wzór



Starlight Effekt · Starlight effect
Effet étoiles · Starlight effekt · Efecto estrella ·
Effetto stelle · Efect de "stele" · Tähti efekti ·
Efekt starlight



RGBW Farbwechsler · RGBW Colorchanging
Changement de couleur RGBW · RGBW Kleurverandering ·
Cambio de color RGBW · Cambia colore RGBW ·
Schimbator de culoare RGBW · Värienvaihto RGB ·
Zmieniający kolor RGBW



Ohne Leuchtmittel · Lamp(s) excluded
Sans ampoule(s) · Zonder lichtbron(nen) ·
Sin bombilla(s) · Lampadina Esclusa · Fara bec (s) ·
Ilman polttimo (s) · Bez żarówki (s)



SWITCH DIM TO WARM
Lichtfarbe mit Schalter einstellbar ·
Light color adjustable with switch
Couleur de lumière réglable avec interrupteur · Lichtkleur
instelbaar met schakelaar · Color de la luz ajustable con
interruptor · Colore della luce regolabile con interruttore ·
Culoarea luminii reglabila cu un comutator · Valon väri
säädettävällä kytkimellä · Kolor światła regulowane z
przełącznikiem



Ausziehbar · Extendible
extensible · Verlengbaar · Extensible ·
Estensibile · extensibila · Jatkettava ·
Rozsuwalny



Memory Funktion · Memory function
fonction mémoire · Geheugen functie ·
Función de memoria · Funzione memorizzazione ·
functia memorie · Muistitoiminto · Funkcja pamięci



indirekte Beleuchtung · indirect lighting
lumière indirecte · indirecte belichting ·
Iluminación indirecta · Illuminazione a scomparsa ·
iluminat indirect · epäsuora valaistus ·
oświetlenie pośrednie



DIP SWITCH
Lichtfarben direkt an der Leuchte einstellbar ·
Colours directly adjustable at the lamp
Les couleurs de la lumière peuvent être réglées directement
sur le luminaire · Lichtkleuren direct instelbaar op de lamp ·
Tonalidades de luz ajustables directamente en la lámpara ·
Colori della luce regolabili direttamente sulla lampada ·
Culori ale luminii reglabile direct de la bec · Valon väri
asetettävissa suoraan valaisimesta · Barwy światła można
ustawić bezpośrednio na oprawie

LED SWITCH DIMMER

DIMMEN OHNE DIMMER DIMMING WITHOUT DIMMER

630



100%

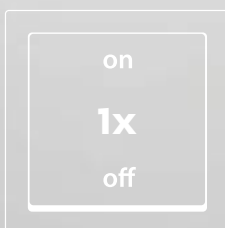

Licht einschalten
Switch on the light



50%

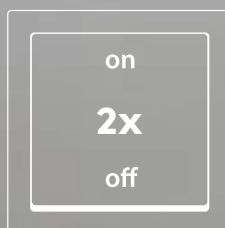

Mehrmals Licht aus- und sofort wieder einschalten
Switch off the light and switch it immediately on again



25%

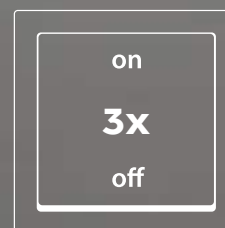

Helligkeit bequem mit jedem
herkömmlichen Lichtschalter steuern

*Adjusting the desired level of brightness with any
conventional light switch*



DIP SWITCH

Mittels DIP SWITCH können drei Lichtfarben (Warmweiß, Neutralweiß, Tageslichtweiß) über einen Schalter direkt an der Leuchte eingestellt werden.

The DIP SWITCH directly sets the luminaire's three light colours (warm, neutral and daylight white).

631

2.300 K

Warmweiß · warm

3.000 K

Neutralweiß · neutral

4.000 K

Tageslichtweiß · daylight white



Diese Wandleuchte ist sowohl für den Festanschluss, als auch für den Betrieb mit Steckerzuleitung geeignet.

This wall light is suitable both for a fixed power connection, as well as for the connection of a plug-in power cable.

Cette applique convient à la fois pour une connexion d'alimentation fixe, ainsi que pour la connexion d'un câble d'alimentation enfichable.

Deze wandlamp is zowel geschikt voor een vaste stroomaansluiting als voor het aansluiten van een plug-in voedingskabel.

Esta luz de pared es adecuada tanto para una conexión de alimentación fija como para la conexión por cable de alimentación

Questa lampada da parete è adatta sia per una connessione di alimentazione fissa, sia per la connessione di un cavo di alimentazione plug-in.

Aceasta aplica este potrivita atat pentru a fi montata direct la sursa de curent, dar si pentru a fi conectata printr-un cablu de curent la priza.

Tämä seinävalaisin voidaan asentaa kiinteästi kytkentäriman avulla tai käyttämällä mukana tulevaa liitosjohtoa.

Ta lampa ścienna jest odpowiednia zarówno do podłączenia na stałe, jak również do eksploatacji przy użyciu przewodu z wtyczką.

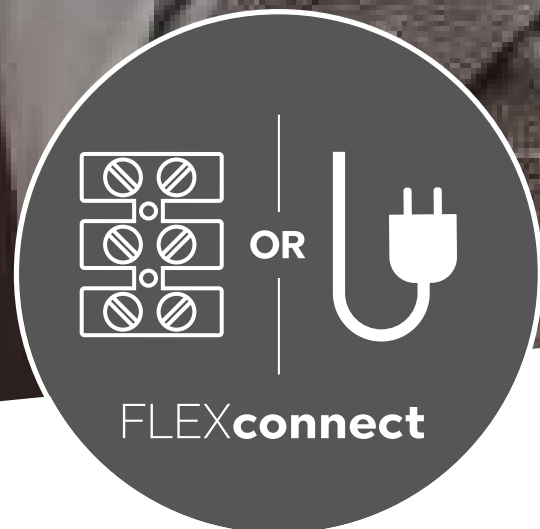

GARANTIEERKLÄRUNG

Warranty Statement · Déclaration de garantie · Garantieverklaring ·
Declaración de garantía · Dichiarazione di garanzia ·
Declarație de garanție · Takuuehdot · Oświadczenie o gwarancji

633



TRIO übernimmt gegenüber Verbrauchern für alle Leuchten mit fest verbauten LEDs eine freiwillige Funktionsgarantie von 5 Jahren. Nähere Informationen hierzu finden Sie in der Garantieerklärung auf unserer Internetseite.
www.trio-leuchten.de

TRIO gives consumers a voluntary functional guarantee of 5 years for all luminaires with permanently installed LEDs. For further information, please visit our website.
www.trio-lighting.com

TRIO donne aux consommateurs une garantie de fonctionnement de 5 ans pour tous les luminaires disposant de LED permanentes. Pour plus d'information, consultez notre site.
www.trio-lighting.com

TRIO biedt consumenten een vrijwillige functionele garantie van 5 jaar op alle verlichtingstoestellen met permanent geïnstalleerde leds. Voor meer informatie, consulteer onze website.
www.trio-lighting.com

TRIO ofrece a los usuarios una garantía funcional de 5 años en todos sus artículos de iluminación que cuentan con luces LED instaladas de forma permanente. Para más información, por favor visite nuestra página web.
www.trio-lighting.com

TRIO offre ai consumatori una garanzia di funzionamento facoltativa di 5 anni per tutti gli apparecchi LED installati in modo permanente. Per ulteriori informazioni, vi preghiamo di visitare il nostro sito web.
www.trio-lighting.com

TRIO oferă consumatorilor o garanție voluntară operațională de 5 ani pentru toate corpurile de iluminat cu LED-uri permanent instalate. Pentru mai multe detalii, va rugăm să vizitați site-ul TRIO.
www.trio-lighting.com

TRIO myöntää kuluttajille vapaaehtoisen 5 vuoden toimintakuun kaikille pysyvästi asennetuille LED-valoille. Lisätietoja verkkosivuiltamme.
www.trio-lighting.com

TRIO daje konsumentom dobrowolną 5-letnią gwarancję funkcjonalną na wszystkie oprawy oświetleniowe z zamontowanymi na stałe diodami LED. Na naszej stronie internetowej może Państwo uzyskać więcej informacji na ten temat.
www.trio-lighting.com

GET YOUR LIGHT CONNECTED.

FR NL ES IT RO FI PL

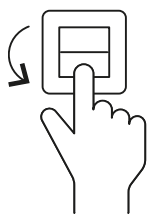

WiZ CLICK

Simple et efficace. Deux modes d'éclairage préférés peuvent être commandés via l'interrupteur d'éclairage existant.

Eenvoudig en effectief. Twee voorkeurstellingen kunnen worden bediend via de bestaande lichtsckelaar.

Helppoa ja tehokasta. Kaksi toivottua valo asetusta jota voidaan käyttää seinäkytkimellä.

Simplu si efectiv. Pot fi operate 2 moduri de iluminat preferate prin comutatorul de lumina existent.

Semplice ed efficace. È possibile utilizzare due modalità di illuminazione preferite tramite l'interruttore della luce esistente.

Simple y efectivo. Dos ambientes de luz preferidos pueden operar a través del interruptor convencional.

Proste i efektywne. Dwa preferowane tryby oświetlenia można obsługiwać za pomocą dostępnego przełącznika oświetlenia.

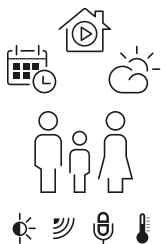

WiZ MAGIC

Contrôle des lumières par programme horraire, par capteurs ou par simples commandes vocales. Compatible avec Amazon Alexa et Google Home.

Aansturing van de lampen met tijdschema's, door sensoren of via eenvoudige spraakopdrachten. Compatibel met Amazon Alexa en Google Home.

Valoja voi säätää aikataulutetusti, sensoreilla tai yksinkertaisilla ääni komennoilla. Yhteensopiva Amazon Alexan ja Google Homen kanssa.

Controlul luminilor prin programarea orei/timpului ,cu senzori sau printr-o simpla comanda verbala.Compatibil cu Amazon Alexa si Google Home.

Controllo delle luci secondo gli orari, con sensori o semplici comandi verbali. Compatibile con Amazon Alexa e Google Home.

Control de las luces con horarios, con sensores o por simples comandos de voz. Compatible con Alexa de Amazon y Google Home.

Ustawianie i sterowanie lampami za pomocą harmonogramów.



WiZ APP

Installation facile et rapide. Toutes les fonctionnalités et flexibilité disponible avec l'application WiZ, téléchargeable sur App Store ou Google Play.

Eenvoudig en snel te installeren. Volledige functionaliteit en flexibilititeit met de WiZ-app - beschikbaar in de App Store of op Google Play.

Helppo ja nopea asentaa. Käyttö WiZ-aplikaatiolla - saatavissa App Storesta tai Google Play kaupasta.

Instalare usoara si rapida.Functionalitate completa si flexibilitate cu WIZ App -disponibil pe App store sau pe Google Play.

Facile e veloce da installare.Piena funzionalità e flessibilità con l'App WiZ disponibile su App Store e su Google Play.

Fácil y rápido de instalar. Amplia funcionalidad y flexibilidad con la aplicación WiZ, disponible en la App Store o en Google Play.

Prosta i szybka instalacja. Pełna funkcjonalność i elastyczność dzięki aplikacji WiZ – dostępnej w App Store lub Google Play.



WiZ MOTE

Contrôle via la télécommande et possibilité de sauvegarder quatre modes d'éclairage favoris.

Aansturen via de afstandsbediening en mogelijkheid om vier favoriete licht instellingen te bewaren.

Toimintojen säätö kaukosäätimellä ja mahdollisuus tallentaa neljä valo asetusta.

Controlul prin telecomanda si posibilitatea de a memora/salva 4 moduri favorite.

Controllo tramite telecomando e possibilità di salvare quattro modalità luce preferite.

Control vía mando a distancia y con posibilidad de guardar 4 ambientes favoritos.

Możliwość sterowania za pomocą pilota i zapisywania czterech preferowanych trybów oświetlenia.



Résidences multiples

Contrôlez et commandez plusieurs résidences simultanément et de n'importe où. Que ce soit votre propre maison ou votre deuxième résidence.

Meerdere locaties

Controleren en aansturen van meerdere locaties tegelijkertijd en van overal. Uw thuis of uw vakantiehuis.

Useita sijainteja

Voit hallita useita sijainteja, kotiasi tai kesäasuntoasi samanaikaisesti.

Locatii Multiple

Control si comanda a locatiilor multiple simultan si de oriunde .Fie ca te afli acasa sau in casa de vacanta

Molteplici Location

Controlla e comanda più sedi contemporaneamente e da qualsiasi luogo. Che tu sia casa tua o la tua casa vacanza.

Múltiples localizaciones

Control y cambio en múltiples localizaciones simultáneamente, tanto tu casa como en tu segunda residencia.

Kilka lokalizacji

Kontrola i sterowanie z kilku lokalizacji jednocześnie i zewsząd. Czy to z własnego domu, czy też z wakacyjnego mieszkania.

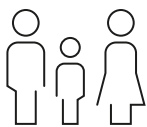

Multiplés utilisateurs

Le nombre de personnes pour contrôler les lumières peut être déterminé individuellement.

Meerdere gebruikers

Het aantal personen dat de lampen aanstuurt, kan individueel worden ingesteld.

Monta eri käyttäjää

WiZ käyttäjien määrä voidaan yksilöllisesti määrittää.

Utilizatori multipli

Numarul de persoane care sa controleze luminile poate fi setat individual.

Molteplici Utenti

Il numero di persone per controllare le luci può essere impostato individualmente.

Múltiples usuarios

El número de personas que controlan las luces se puede configurar individualmente.

Kilku käyttäjää

Liczba użytkowników mogących sterować lampami może być określana indywidualnie.

Basato sul Cloud

WiZ si connette al cloud per memorizzare le preferenze, condividere desideri e generare automaticamente gli aggiornamenti.

Basado en la nube

WiZ conecta con la nube para guardar tus preferencias, comparte y genera actualizaciones automáticamente.

Oparte na chmurze

WiZ łączy się z chmurą, aby zapisywać preferencje, rozdzielać życzenia i automatycznie generować aktualizacje.

Numerose stanze

Tutte le luci possono essere assegnate a stanze diverse e controllate con precisione - individualmente o in gruppi.

Varias habitaciones

Todas las luces pueden ser asignadas a diferentes habitaciones y controladas con precisión - individualmente o en grupo.

Kilka pomieszczeń

Wszystkie lampy mogą być przyporządkowywane do różnych pomieszczeń i precyzyjnie sterowane – pojedynczo lub w grupach.

Non sono necessari altri hub

Non è necessario un ponte o un hub aggiuntivo per controllare le luci.

No necesaria una unidad central

No es necesario una conexión adicional o unidad central para controlar las luces.

Bez konieczności stosowania dodatkowych mostków

Do sterowania lampami nie jest potrzebny żaden dodatkowy mostek.

Tecnologia Wi-Fi

WiZ utilizza la tecnologia Wi-Fi come soluzione wireless sicura, indipendente, economica e facile da installare.

Tecnología WiFi

WiZ utiliza la tecnología Wi-Fi como una solución inalámbrica segura, independiente, asequible y fácil de instalar.

Technologia WLAN

WiZ używa technologii „WLAN” jako bezpiecznego, niezależnego, niskonakładowego i łatwego w instalacji rozwiązania radiowego.



Basé sur le cloud

WiZ se connecte au cloud pour stocker les préférences, partager les désirs et générer automatiquement des mises à jour.

Cloud gebaseerd

WiZ maakt verbinding met de cloud om voorkeuren op te slaan, wensen te delen en automatische updates te genereren.

Pilvipalveluun perustuva

WiZ ottaa yhteyden pilvipalveluun, tallentaa asetukset ja luo päivitykset automaattisesti.

Pe baza de Cloud

WiZ te conectează la Cloud la magazinul preferat, transmite dorințele și generează update-uri în mod automat.

Lieux multiples

Toutes les lumières peuvent être assignées à différentes pièces et contrôlées avec précision - individuellement ou en groupe.

Meerder woonruimtes

Alle lampen kunnen worden toegewezen aan verschillende woonruimtes en nauwkeurig worden aangestuurd - individueel of in groepen.

Useita huoneita

Jokainen valo voidaan määrittää eri huoneelle. Hallittavissa ryhmissä tai yksittäin.

Câteva camere

Toate luminile pot fi atribuite mai multor camere diferite și pot fi controlate cu precizie -individual și în grupuri.

Pas besoin de pont

Il n'y a pas besoin d'un dispositif supplémentaire pour contrôler les lumières.

Geen hub nodig

Er is geen extra apparaat nodig om de lampen aan te sturen.

Ei tarvetta erilliselle keskukselle

Ei tarvetta erilliselle keskukselle valojen säätämiseen.

Nu e nevoie de nici un punct central

Nu e nevoie de o punte sau hub pentru a controla luminile.

Technologie WiFi

WiZ utilise la technologie WiFi comme une solution sans fil sécurisée, indépendante, abordable et facile à installer.

WiFi-technologie

WiZ gebruikt Wi-Fi-technologie als een veilige, onafhankelijke, betaalbare en eenvoudig te installeren draadloze oplossing.

WiFi teknologia

WiZ käyttää Wi-Fi teknologiaa turvallisena, itsenäisenä, edullisena ja helppo käyttöisenä langattomana ratkaisuna.

Technologie Wi-Fi

WiZ folosește tehnologia Wi-Fi ca o soluție de internet sigură, independentă, permisivă și ușor de instalat.



DUOLINE

Système de voie à deux phases (230 V) · 2-fase-spoorsysteem (230 V) · Sistema de rieles en 2 fases (230 V) · Sistema a binario bifase (230 V) · Sistem de piste cu 2 faze (230 V) · 2-vaihekiskojärjestelmä (230 V) · 2-fazowy system prowadnic (230 V)

FR NL ES IT RO FI PL

Les avantages de DUOLINE en un coup d'œil :

- Conception individuelle de l'éclairage
- Une seule connexion électrique requise
- Pas besoin de transformateur
- Les luminaires peuvent être librement combinés et facilement déplacés
- Deux scénarios lumineux différents
- Commutation et variateur de lumière séparés
- Convient pour le montage au plafond et au mur

Lors de la planification, veuillez prêter une attention particulière à la position du conducteur de protection, qui doit être connecté en permanence dans le système.

I vantaggi di DUOLINE in sintesi:

- Progettazione individuale dell'illuminazione
- È necessario un solo collegamento di alimentazione
- Non è necessario alcun trasformatore
- Le lampade possono essere liberamente combinate e facilmente spostate
- Due differenti scenari di illuminazione
- Commutazione e dimmerazione separate
- Adatto per il montaggio a soffitto e a parete

In fase di progettazione, prestare attenzione alla posizione del conduttore di protezione, che deve essere collegato in modo continuo all'interno dell'impianto.

Zalety DUOLINE w skrócie:

- Indywidualny projekt oświetlenia
- Wymagane jest tylko jedno połączenie zasilania
- Nie wymaga transformatora
- Oprawy można dowolnie łączyć i łatwo przemieszczać
- Dwa różne scenariusze oświetlenia

1 Rail

La longueur maximale de l'installation est de 30 mètres par alimentation, avec une puissance totale maximale de 600 watts par phase.

Spoor

De maximale montage lengte bedraagt 30 meter per voeding, bij een een totaal vermogen van max. 600 watt per fase.

Riel

La longitud máxima de montaje es de 30 metros por alimentación, con una potencia total de 600 vatios como máximo por fase.

Binario

La lunghezza massima di installazione è di 30 metri per ogni alimentazione, con una potenza totale di max. 600 watt per fase.

Pistă

Lungimea maximă de montaj este de 30 de metri pe fiecare sursă de alimentare, la o putere totală de max. 600 W pe fază.

Kisko

Asennuksen enimmäispituus on 30 metriä syöttöä kohti, kokonaisteho enintään 600 W/vaihe.

Szyna

Maksymalna długość montażu wynosi 30 metrów na linię zasilania z łączną mocą 600 watów na jedną fazę.

2 Alimentation électrique intermédiaire/finale

L'alimentation du milieu/extrémité est montée directement au-dessus de la prise de courant et permet de connecter des rails d'un côté ou des deux côtés.

Midden-/eindevoeding

De midden-/eindevoeding wordt direct over de stroomuitgang aangebracht en maakt het mogelijk sporen op één of beide kanten aan te sluiten.

Alimentación medios/extremos

La alimentación de medios/extremos se adapta directamente mediante la toma de corriente, y permite que las lámparas se conecten por un lado o por los dos.

Alimentazione centrale/finale

L'alimentazione centrale/finale è montata direttamente sopra la presa di corrente e

Overzicht van de voordelen van DUOLINE:

- Individuele lichtvormgeving
- Slechts één stroomaansluiting nodig
- Geen transformator nodig
- Lampen willekeurig combineerbaar en gemakkelijk verplaatsbaar
- Twee verschillende lichtscenario's
- Apart schakelen en dimmen
- Geschikt voor plafond- en muurmontage

Let bij de planning absoluut op de positie van de beschermende geleider die binnen het systeem ononderbroken verbonden moet zijn.

Avantajele DUOLINE dintr-o privire:

- Structurarea individualizată a luminii
- Este necesară o singură conexiune electrică
- Nu este necesar un transformator
- Lămpile pot fi combinate liber și pot fi deplasate cu ușurință
- Două scenarii de iluminat diferite
- Comutare și reglare a intensității separate
- Adecvat pentru montajul pe plafon și pe perete

La planificare, luați neapărat în considerare poziția conductorului de protecție, care trebuie să fie conectat continuu în interiorul sistemului.

- Oddzielne włączanie i ściemnianie
- Nadaje się do montażu sufitowego i ściennego

Podczas projektowania należy zwrócić uwagę na położenie przewodu ochronnego, który musi być podłączony w całym systemie.

Las ventajas de DUOLINE en resumen:

- Diseño lumínico individual
- Solo un cable de corriente necesario
- Ningún transformador necesario
- Lámpara combinables libremente y fácilmente desplazable
- Dos escenarios lumínicos diferentes
- Activación y atenuación separadas
- Adecuado para su montaje en techo y pared

Al planificar, por favor, tenga en cuenta la posición de la toma de tierra, que debe estar conectado a lo largo de todo el sistema.

DUOLINEN EDUT LYHYESTI:

- Yksilöllinen valaistussuunnittelu
- Vaaditaan vain yksi sähköliitäntä
- Muuntajaa ei tarvita
- Valaisimia voidaan yhdistellä vapaasti ja siirtää helposti
- Kaksi erilaista valaistusskenaariota
- Erillinen kytkentä ja himmennys
- Sopii katto- ja seinäasennukseen

Huomioi suunnittelussa koko järjestelmään kytkettävän suojaadoituksen sijainti.

consente di collegare le guide su un lato o su entrambi i lati.

Alimentare centrală/finală

Alimentare centrală/finală este realizată direct prin intermediul conexiunii electrice și permite conectarea pistolor pe o parte sau pe ambele părți.

Keski-/päätyisyöttö

Keski-/päätyisyöttö asennetaan suoraan pistorasian yläpuolelle, ja se mahdollistaa kiskojen kytkemisen toiselle tai molemmille puolille.

Zasilanie pośrednie / końcowe

Zasilanie środkowe / końcowe jest instalowane bezpośrednio nad gniazdem zasilania i umożliwia podłączenie szyn z jednej lub z obu stron.

3 Alimentation intermédiaire/finale avec changeur de phase électronique

Grâce à un changeur de phase électronique, les deux phases peuvent être commutées et atténuées séparément, même avec des lignes électriques à trois conducteurs.

Midden-/eindevoeding met elektronische fasewisselaar

Door middel van een elektronische fasewisselaar kunnen de twee fasen ook bij driedradige stroomleidingen apart geschakeld en gedimd worden.

Alimentación medios/extremos con cambiador de fase electrónico

Por medio de los cambiadores de fase electrónicos, las dos fases pueden activarse y atenuarse también mediante cables de corriente de tres filamentos.

Alimentazione centrale/finale con variatore di fase elettrico

Mediante un variatore di fase elettrico, le due fasi possono essere commutate e dimmerate separatamente, anche con linee di alimentazione a tre conduttori.

Alimentare centrală/finală cu schimbător electronic de fază

Prin intermediul dispozitivului electronic de schimbare a fazelor se pot comuta și regla două faze chiar și în cazul cablurilor electrice cu trei fire.

Keski-/päätyisyöttö elektronisella vaihtimella

Sähköistä vaihdinta käyttämällä nämä kaksi vaihetta voidaan kytkeä ja himmentää erikseen jopa kolmijohtimisella kaapeloinnilla.

Zasilanie pośrednie / końcowe z elektronicznym przełącznikiem faz

Za pomocą elektronicznych zmieniaaczy faz obie fazy można przełączać i przyciemniać osobno, nawet w przypadku trójprzewodowych linii zasilania.

- 4 Connecteur longitudinal**
Relie deux rails entre eux pour des sections droites.
Longitudale verbinder
Verbindt twee sporen voor rechte stukken met elkaar.
Ensamblaje recto
Ensamble dos rieles para tramos rectos entre si.
Connettore longitudinale
Unisce due binari per sezioni rettilinee.
Conector longitudinal
Conectează două piste pentru trasee drepte unele cu altele.
Suora liitin
Yhdistää kaksi kiskoa suoria osuuksia varten.
Przedłużacz
Łączy dwie szyny dla prostych odcinków.
- 5 Connecteur Flex**
Relie deux rails entre eux sous n'importe quel angle et relie le montage au plafond à celui au mur.
Flexibele verbinder
Verbindt twee sporen in een willekeurige hoek met elkaar en maakt de verbinding tussen plafond- en muurmontage mogelijk.
Ensamblaje flexible
Ensamble dos rieles con cualquier ángulo entre si y permite la conexión entre el montaje en techo y paredes.
Connettore flessibile
Collega tra loro due binari con qualsiasi angolazione e consente il collegamento tra il montaggio a soffitto e a parete.
Conector Flex
Conectează două șine într-un unghi aleatoriu între ele și permite conectarea între sistemele de montaj pe plafon și pe perete.
Flex-liitin
Yhdistää kaksi kiskoa mihin tahansa kulmaan ja mahdollistaa yhteyden katto- ja seinäkiinnityksen välillä.
Łącznik elastyczny
Łączy dwie szyny pod dowolnym kątem i umożliwia połączenie między sufitem a ścianą.
- 6 Raccord en L**
7 Relie deux rails entre eux à angle droit.
L-Connector
Verbindt twee sporen in een rechte hoek met elkaar.
Conector en L
Ensamble dos rieles en ángulo recto entre si.
Connettore a L
Collega insieme due binari ad angolo retto.
Conector în L
Conectează două piste pentru trasee în unghi drept unele cu altele.
L-Liitin
Yhdistää kaksi kiskoa toisiinsa suorassa kulmassa.
Złącze L
Łączy dwie szyny pod kątem prostym.
- 8 Raccord en T**
9 Relie trois rails entre eux à angle droit.
10 T-Connector
Verbindt drie sporen in een rechte hoek met elkaar.
Conector en T
Ensamble tres rieles en ángulo recto entre si.
Connettore a T
Collega insieme tre binari ad angolo retto.
Conector în T
Conectează trei șine în unghi drept unele de altele.
T-Liitin
Yhdistää kolme kiskoa suorassa kulmassa toisiinsa.
Złącze T
Łączy trzy szyny pod kątem prostym.
- 11 Connecteur X**
Relie quatre rails entre eux à angle droit.
X-verbinder
Verbindt vier sporen in een rechte hoek met elkaar.
Ensamblaje en X
Ensamble cuatro rieles en ángulo recto entre si.
Connettore a X
Collega insieme quattro binari ad angolo retto.
Conector X
Conectează patru șine în unghi drept între ele.
X-liitin
Yhdistää neljä kiskoa suorassa kulmassa toisiinsa nähden.
Łącznik X
Łączy cztery szyny pod kątem prostym.
- 14 Isolateur**
Grâce à un isolateur, deux circuits séparés peuvent être reliés optiquement pour former un système.
Isolator
Door middel van de isolator kunnen twee aparte stroomkringen optisch verbonden worden tot één systeem.
Aislador
Por medio del aislador pueden conectarse dos circuitos de forma óptica a un sistema.
Isolatore
Utilizzando un isolatore, due circuiti separati possono essere collegati otticamente per formare un sistema.
Izolator
Prin intermediul izolatorului este posibilă conectarea optică a două circuite de comutare într-un sistem.
Eristin
Eristimen avulla kaksi erillistä piiriä voidaan kytkeä optisesti yhden järjestelmän muodostamiseksi.
Izolator
Za pomocą izolatora można optycznie połączyć dwa oddzielne obwody w celu utworzenia systemu.
- 15 Adaptateur pendulaire**
Cet adaptateur pendulaire permet d'intégrer des luminaires suspendus conventionnels dans le système de rail DUOline.
Hangadapter
Deze hangadapter maakt het mogelijk gewone hanglampen in het DUOline-spoorsysteem te integreren.
Adaptador colgante
Este adaptador colgante le permite integrar las lámpara colgantes convencionales en el sistema de rieles de DUOline.
Adattatore per sospensione
Questo adattatore per sospensione consente l'integrazione di lampade a sospensione convenzionali nel sistema a binario DUOline.
Adaptor lustre
Acest adaptor pendular permite integrarea lustrelor uzuale în sistemul de piste DUOline.
Riippuväläisinsovitin
Tämä riippuväläisinsovitin mahdollistaa tavallisten riippuväläisimien integroinnin DUOline-kiskojärjestelmään.
Adapter zawieszania
Ten adapter do zawieszania umożliwia zintegrowanie tradycyjnych lamp wiszących z systemem szyn DUOline.
- 16 Raccourcisseur de câble**
Permet de raccourcir les câbles des luminaires suspendus.
Snoerverkorter
Maakt het inkorten van het snoer van hanglampen mogelijk.
Akortador de cable
Es posible acortar el cable de las lámparas colgantes.
Sistema per accorciare il cavo
Permette di accorciare i cavi delle lampade a sospensione.
Prescurtare cablu
Permite scurțarea cablurilor lustrelor.
Johdon lyhennin
Mahdollistaa riippuväläisimien johdon lyhentämisen.
Skracacz kabla
Pozwala skrócić kable lamp wiszących.
- 17 Alimentation électrique flexible**
L'alimentation électrique flexible est nécessaire si les rails ne peuvent pas être posés directement sur la prise de courant.
Flexibele stroomtoevoer
Flexibele stroomtoevoer is nodig, als de sporen niet direct over de stroomuitgang gelegd kunnen worden.
Suministro de corriente flexible
El suministro de corriente flexible será necesario si las lámparas no pueden desplegarse directamente sobre la toma de corriente.
Sistema di alimentazione flessibile
Il sistema di alimentazione flessibile è necessario se i binari non possono essere posati direttamente sulla presa di corrente.
Alimentarea electrică flexibilă
Alimentarea electrică flexibilă este necesară atunci când pistele nu pot fi pozate direct prin intermediul racordului electric.
Joustava virransyöttö
Joustava virtälähde on tarpeen, jos kiskoja ei voida asentaa suoraan pistorasian yläpuolelle.
Elastyczne zasilani
Elastyczny zasilanie jest wymagane, jeśli szyny nie mogą być układane bezpośrednio nad gniazdem zasilania.

Seite Page	Artikel-Nr. Product No.	EAN-Nummer EAN-Number	Ersatzteile Spare parts	Seite Page	Artikel-Nr. Product No.	EAN-Nummer EAN-Number	Ersatzteile Spare parts
152	101000324	4017807504675	G1010-01	469	208870132	4017807388473	
152	101000524	4017807504682	G1010-01	108	209100107	4017807398564	S5091-01
232	101600506	4017807430165		108	209100108	4017807398571	S5091-01
232	101600806	4017807430172		258	209500167	4017807488906	
227	101700332	4017807522730		182	212200100	4017807522013	G2122-52
227	101700532	4017807522747		513	212400201	4017807408799	
234	102000403	4017807387919		515	212400204	4017807490510	
234	102000405	4017807387926		515	212400207	4017807408850	
156	110300428	4017807369151		513	212400224	4017807408867	
228	110600331	4017807343656	92712-01	513	212400232	4017807408812	
228	110600378	4017807343663	92712-78	376	212600130	4017807526288	G21261-01
228	110600531	4017807343670	92712-01	376	212600156	4017807526561	G21261-01
228	110600578	4017807343687	92712-78	376	212600230	4017807526318	G21262-01
158	110700328	4017807354140	92809	376	212600256	4017807526578	G21262-01
158	110700528	4017807354164	92809	405	212700104	4017807522129	G21271-01
229	112900531	4017807504941		405	212700107	4017807522112	G21271-01
229	112900542	4017807509328		405	212700204	4017807522143	G21272-01
229	112900931	4017807504934		405	212700207	4017807522136	G21272-01
229	112900942	4017807509335		422	214470107	4017807539493	S2144-01
386	200200132	4017807463019		422	214470108	4017807539523	S2144-01
387	200300132	4017807462982		422	214470132	4017807539554	S2144-01
409	200400100	4017807398694	92860	401	220810201	4017807258363	92335
386	200600132	4017807462821	S2006-02	401	220810205	4017807258370	92335
159	200700128	4017807354188	92809	382	222270231	4017807387414	
404	200970124	4017807211832	92396	382	222270232	4017807387421	
411	201000101	4017807409642		382	222370231	4017807387025	
410	201100201	4017807409666		382	222370232	4017807387032	
188	201200100	4017807398632	92854	383	222570231	4017807399875	
232	201600206	4017807430158		383	222570232	4017807399882	
168	202000108	4017807436051	G2020-01	397	223210131	4017807386974	
166	202000132	4017807506372	G2020-01	397	223210132	4017807386981	
166	202000142	4017807432893	G2020-54	393	223310105	4017807371765	
408	202400106	4017807244908	92579	393	223310131	4017807371772	
189	202500101	4017807364927	92831-20	393	223310132	4017807371789	
385	202670107	4017807524017		392	223410131	4017807303025	
385	202670108	4017807526547		392	223410132	4017807306309	
385	202670131	4017807524055		134	223510131	4017807421859	
385	202670132	4017807524079		134	223510132	4017807421910	
285	203000132	4017807522716		134	223510231	4017807421965	
250	203000230	4017807507041		134	223510232	4017807421996	
185	204400101	4017807364972	92830-22	251	223710130	4017807441871	
403	204700101	4017807276541	92717-13	251	223790130	4017807441895	
252	205570167	4017807442540		378	223810279	4017807299472	
252	205570267	4017807442564		395	223910132	4017807451955	
378	206400279	4017807364361		395	223910167	4017807441147	
378	206500279	4017807364378		379	224110179	4017807329018	
396	206600278	4017807364347		330	224210102	4017807465914	
288	207000188	4017807356076		330	224290102	4017807465921	
384	207500179	4017807382860		390	224810131	4017807502749	
384	207500189	4017807382877		390	224810132	4017807502756	
190	207800100	4017807189148	92259-20	390	224810167	4017807502763	
160	208070131	4017807407235		390	224819131	4017807502770	
160	208070132	4017807407242		390	224819132	4017807502787	
186	208700179	4017807385342	92920-79	390	224819167	4017807502794	
186	208700189	4017807385359	92920-89	394	224910231	4017807454413	

Seite Page	Artikel-Nr. Product No.	EAN-Nummer EAN-Number	Ersatzteile Spare parts	Seite Page	Artikel-Nr. Product No.	EAN-Nummer EAN-Number	Ersatzteile Spare parts
394	224910232	4017807454437		400	274813005	4017807414790	
399	225172924	4017807404517		92	275510207	4017807455830	
399	225172931	4017807404555		92	275510232	4017807455823	
399	225172942	4017807433401		389	279770104	4017807275346	
399	225174724	4017807404586		389	279770107	4017807275353	
399	225174731	4017807404593		389	279770108	4017807275360	
399	225174742	4017807433425		389	279770132	4017807542363	
388	225210104	4017807256314		604	2803021-06	4017807147599	9579-01
388	225210107	4017807256338		604	2803031-06	4017807147605	9579
398	225271007	4017807468823		586	281570606	4017807245967	
398	225271031	4017807468830		586	281570906	4017807245950	
398	225271507	4017807468878		576	282410106	4017807280821	
398	225271531	4017807468885		576	282410206	4017807280838	
398	225272007	4017807468908		596	282990106	4017807345070	
398	225272031	4017807468915		579	283110106	4017807382846	
396	225510207	4017807277913		579	283110132	4017807508000	
381	229210207	4017807413304		579	283110206	4017807382853	
381	229210231	4017807413281		579	283110232	4017807508024	
381	229210232	4017807413298		588	283270106	4017807384048	
100	241670132	4017807542516		588	283270132	4017807508116	
68	241810205	4017807541793		588	283270206	4017807384055	
66	241810208	4017807541861		588	283270232	4017807508123	
300	242910180	4017807550726		588	283270306	4017807384062	
404	2502211-07	4017807103908	9413-01	588	283270332	4017807508154	
402	2522011-06	4017807080797	92105	593	283400106	4017807508246	
402	2523011-01	4017807094756	9327-01	593	283400132	4017807508253	
59	253310105	4017807464443	92873IR	592	283500106	4017807513967	
59	253310131	4017807464481	92873IR	592	283500132	4017807513998	
59	253310132	4017807464528	92873IR	597	283600406	4017807514018	
58	255410207	4017807415162	92873IR	575	283770106	4017807508079	
128	271170201	4017807247251	92765-01	575	283770132	4017807508086	
128	271170202	4017807247268	92765-02	575	283779106	4017807508093	
128	271170211	4017807508680	92765-11	575	283779132	4017807508109	
380	271470207	4017807374681	92940-01	582	283811206	4017807507997	
380	271470279	4017807374698	92940-02	582	283811232	4017807507980	
417	272970401	4017807284652		582	283814206	4017807507959	
417	272970487	4017807284669		582	283814232	4017807507942	
417	272970701	4017807284676		582	283817906	4017807507966	
417	272970787	4017807284683		582	283817932	4017807507973	
419	273070401	4017807284690		580	283916006	4017807507904	
419	273070701	4017807284706		580	283916032	4017807507911	
419	273071301	4017807284713		580	283919006	4017807507928	
419	273071801	4017807284720		580	283919032	4017807507935	
416	273170301	4017807284737		584	284071206	4017807507638	
416	273170387	4017807284744		584	284071232	4017807507645	
416	273170401	4017807284751		584	284074206	4017807507676	
416	273170487	4017807284768		584	284074232	4017807507683	
415	273271201	4017807329087		584	284077906	4017807507652	
415	273271801	4017807329094		584	284077932	4017807507669	
418	273370307	4017807284799		590	284114006	4017807507591	D2841-06
359	274510107	4017807381559		590	284114032	4017807507607	D2841-32
400	274670105	4017807293968		590	284116006	4017807507614	D2841-06
400	274670205	4017807293975		590	284116032	4017807507621	D2841-32
460	274770107	4017807390049		165	300500104	4017807267112	
460	274770132	4017807390056		178	300600331	4017807467338	G30062-52

Seite Page	Artikel-Nr. Product No.	EAN-Nummer EAN-Number	Ersatzteile Spare parts	Seite Page	Artikel-Nr. Product No.	EAN-Nummer EAN-Number	Ersatzteile Spare parts
178	300600342	4017807467345	G30062-54	295	304500162	4017807286175	92740
290	300700102	4017807298666		236	304800142	4017807277944	92720-42
290	300900101	4017807298673		268	305300488	4017807445237	
290	300900102	4017807298680		117	305400401	4017807336948	
271	301000367	4017807478167	G3010-52	117	305400411	4017807336955	93782-11
276	301200101	4017807502626	S3012-01	117	305400441	4017807391022	
277	301200201	4017807502633	S3012-01	117	305400479	4017807336962	93782-79
188	301200300	4017807398649	92855	117	305400489	4017807336979	93782-89
224	301300142	4017807390322		253	305500467	4017807441093	92987
224	301300342	4017807390346		237	305900126	4017807330816	
224	301300442	4017807390353		237	305900130	4017807330809	
242	301400101	4017807195422	92270-01	231	306200832	4017807467864	
243	301700107	4017807196009	9408-01	148	306700602	4017807373912	
243	301700108	4017807196016	9408-01	148	306700632	4017807364392	
261	301900467	4017807502602		149	306700732	4017807399905	
168	302000308	4017807436112	G2020-01	288	307000188	4017807356090	
167	302000332	4017807506389	G2020-01	288	307000688	4017807356106	
167	302000342	4017807433067	G2020-54	244	307290101	4017807343748	
168	302000608	4017807522778	G2020-01	238	307400331	4017807408010	
166	302000632	4017807522754	G2020-01	172	307601206	4017807426861	G50761-54
166	302000642	4017807522761	G2020-54	190	307800100	4017807189155	92258-30
278	302100130	4017807451252	S30211-01	190	307804100	4017807190083	92258-40
278	302100430	4017807451269	S30212-01	150	307900432	4017807502701	
222	302400404	4017807523355		238	308000132	4017807288827	
221	302400407	4017807523416		270	308100567	4017807451221	
221	302400431	4017807523492		119	308200179	4017807392517	
221	302400432	4017807523515		104	308300307	4017807510638	92980-01
222	302400480	4017807523454					92983-07
222	302400604	4017807523577					92976-11
221	302400607	4017807523591		106	308300308	4017807510645	92980-01
221	302400631	4017807523638					92983-08
221	302400632	4017807523652					92976-01
222	302400680	4017807523614		170	308500542	4017807468601	G40342-54
189	302500301	4017807364934		170	308590342	4017807468625	G40342-54
286	302900102	4017807292497	92779	235	308600706	4017807378306	B3086-00
285	303000132	4017807476781					P3086-06
285	303090132	4017807476798		187	308700189	4017807385373	92925-89
125	303300101	4017807288292	92989-01	187	308700289	4017807385397	92924-89
125	303300102	4017807288308		130	308900331	4017807405224	C0089-01
125	303300111	4017807508703	92989-11	130	308900342	4017807425451	C0089-01
255	303400167	4017807425376		130	308900631	4017807425581	C3089-01
254	303400367	4017807425383		130	308900642	4017807425604	C3089-01
135	303500331	4017807422061	C3035-01	266	309000167	4017807473421	
135	303500332	4017807422078	C3035-01	266	309090167	4017807473414	
294	303700104	4017807286601		239	309300302	4017807354102	92836-04
294	303700161	4017807286618					92836-05
294	303700162	4017807286625					92836-06
244	304100100	4017807247411	92634				92836-07
244	304100106	4017807247404	92634-06	120	309400317	4017807423723	
275	304300132	4017807467499		258	309500167	4017807488937	
274	304300432	4017807467567		258	309500467	4017807488951	
275	304330332	4017807467512		132	309800431	4017807387681	92887
185	304400201	4017807364989	92830-040	132	309800432	4017807387698	92887
295	304500104	4017807286151	92740	142	309900631	4017807330946	
295	304500161	4017807286168	92740	142	309900632	4017807330953	92943

Seite Page	Artikel-Nr. Product No.	EAN-Nummer EAN-Number	Ersatzteile Spare parts	Seite Page	Artikel-Nr. Product No.	EAN-Nummer EAN-Number	Ersatzteile Spare parts
287	310100104	4017807408607		216	313100531	4017807538496	G3131-01
293	310100162	4017807356021		216	313100532	4017807538519	G3131-02
287	310100204	4017807408591		216	313100931	4017807538489	G3131-01
293	310100562	4017807356045		216	313100932	4017807538472	G3131-02
214	310300132	4017807532951	G3103-54	162	313300307	4017807503647	
214	310300532	4017807522471	G3103-54	162	313300308	4017807503678	S3133-08
214	310390332	4017807522488	G3103-54	162	313300332	4017807503630	
180	310600101	4017807504453	G0106-31	162	313300407	4017807503715	
180	310600132	4017807427264	G0106-54	162	313300408	4017807503739	
180	310600154	4017807507478	G0106-54	162	313300432	4017807503692	
180	310600401	4017807504538	G0106-31	218	313400107	4017807504293	
180	310600432	4017807427288	G0106-54	218	313400131	4017807504255	
180	310600454	4017807507515	G0106-54	218	313400132	4017807504279	
180	310630301	4017807504491	G0106-31	218	313400407	4017807504354	
180	310630332	4017807435696	G0106-54	218	313400431	4017807504316	
180	310630354	4017807507492	G0106-54	218	313400432	4017807504330	
265	310700432	4017807502848		218	313400607	4017807504415	
265	310730332	4017807502831		218	313400631	4017807504378	
226	310800108	4017807503845		218	313400632	4017807504392	
226	310800308	4017807503852		272	313800332	4017807502855	
226	310890108	4017807503838	S31082-08	272	313800532	4017807502862	
286	310900111	4017807349160		138	313900132	4017807505061	S3139-32
140	311100308	4017807537826					G3139-01
140	311100367	4017807537703		138	313900232	4017807505085	S3139-32
175	311210506	4017807367768	92829-40				G3139-01
			92833-10	249	314300430	4017807538915	
			92833-12	176	315190132	4017807539646	G3151-57
			92833-14	230	315200109	4017807288001	92735-09
174	311210606	4017807367775	92829-50	230	315200179	4017807287998	92735-79
			92833-10	282	315900132	4017807540246	
			92833-12	282	315900142	4017807540277	
			92833-14	273	316500432	4017807540604	
			92833-16	212	317000332	4017807542271	G31701-57
110	311400132	4017807538526					G31702-57
110	311400432	4017807538410					G31703-57
145	311900632	4017807536607		212	317000632	4017807542295	G31701-57
145	311900732	4017807537949					G31702-57
280	312200136	4017807544817					G31703-57
182	312200200	4017807522006	G3122-52	212	317000832	4017807542301	G31701-57
280	312200336	4017807544800					G31702-57
284	312300136	4017807504620	S3123-36				G31703-57
220	312400101	4017807408713		90	320310307	4017807487909	
220	312400107	4017807408737		90	320310308	4017807487916	
220	312400132	4017807408720		90	320310331	4017807487930	
220	312400401	4017807408751		90	320310332	4017807487923	
220	312400407	4017807408775		70	321210107	4017807454000	
220	312400432	4017807408768		70	321210108	4017807461145	
223	312490407	4017807523676		204	321611131	4017807468724	92957
223	312490431	4017807523690		204	321611132	4017807468731	
223	312490432	4017807523720		204	321691131	4017807468748	
223	312490607	4017807523744		204	321691132	4017807468755	
223	312490631	4017807523805		77	321710107	4017807430486	
223	312490632	4017807523843		77	321710142	4017807430493	
262	312700132	4017807502725		200	321910207	4017807453560	
262	312700432	4017807502718		200	321910242	4017807453577	

Seite Page	Artikel-Nr. Product No.	EAN-Nummer EAN-Number	Ersatzteile Spare parts	Seite Page	Artikel-Nr. Product No.	EAN-Nummer EAN-Number	Ersatzteile Spare parts
200	321910307	4017807453584		196	342010107	4017807542066	G3420-01
200	321910342	4017807453607		196	342010108	4017807542080	G3420-01
83	322610232	4017807424324		194	342010132	4017807542073	G3420-57
82	322610431	4017807424294		196	342010207	4017807542097	G3420-01
82	322610432	4017807424300		196	342010208	4017807542134	G3420-01
84	322610489	4017807497809		194	342010232	4017807542127	G3420-57
96	322910532	4017807524963		196	342010307	4017807542141	G3420-01
199	323610307	4017807506365		196	342010308	4017807542158	G3420-01
199	323610331	4017807506341		194	342010332	4017807542172	G3420-57
199	323610332	4017807506358		211	342710205	4017807542318	
251	323710130	4017807451191		211	342710208	4017807542233	
79	324610131	4017807472912	D0246-31	245	3490400-00	4017807062465	
79	324610132	4017807470932	D0246-32	245	3491400-00	4017807081541	
79	324610179	4017807470949	D0246-79	47	352710307	4017807453775	92873IR
240	324810407	4017807257649	98249 98248	47	352710342	4017807473308	92873IR
76	325010105	4017807422627		245	3590010-01	4017807062496	
76	325010132	4017807422634		240	371010307	4017807281750	92734-01 92910
202	325110131	4017807467758		240	371010308	4017807281767	92734-01 92910
202	325110132	4017807467789		240	371010407	4017807281781	92734-01 92910
202	325110179	4017807467796		240	371010408	4017807281798	92734-01 92910
208	325510407	4017807367973	92833 92944	74	371310105	4017807445336	
208	325510507	4017807367980	92833 92944	74	371310131	4017807451801	
203	325610305	4017807388022		74	371310142	4017807445343	
72	326210107	4017807505221		241	3751031-07	4017807137729	9350
72	326210131	4017807505207		241	3751041-07	4017807137736	9350
72	326210132	4017807505214		241	3751051-07	4017807169027	9350
98	326410130	4017807505412		206	375310502	4017807504446	
65	326510107	4017807510034		206	375310505	4017807504439	
65	326510108	4017807510041		206	375310507	4017807472226	
65	326510142	4017807510058		206	375310508	4017807481839	
65	326510207	4017807510065		206	375310532	4017807472233	
65	326510208	4017807510072		93	375510407	4017807469844	
65	326510242	4017807510089		93	375510432	4017807469882	
65	326510307	4017807510096		209	379190707	4017807362831	
65	326510308	4017807510102		209	379190732	4017807471229	
65	326510342	4017807510119		123	393900317	4017807505504	S3939-01 S3939-02 S3939-11
103	326610207	4017807505467		123	393900517	4017807505511	S693920-11 S693925-02 S693930-02 S693935-01 S693940-01
103	326610232	4017807505474		431	400200107	4017807368390	92820-01 92820
88	326810131	4017807506525		431	400200108	4017807378320	92820-01 92820-08
88	326810132	4017807506518		430	400400107	4017807423211	S4004-11
210	327210305	4017807504200		430	400400132	4017807423228	S4004-11
210	327210332	4017807504194		165	400500104	4017807268621	
242	3407011-07	4017807103724	9408-01	154	401000224	4017807504712	G4010-01
136	340910131	4017807537956					
137	340910132	4017807537970					
136	340910331	4017807537994					
137	340910332	4017807538106					
86	341210305	4017807540161					
86	341210308	4017807540086					
101	341610132	4017807542455					
69	341810205	4017807540710					
67	341810208	4017807540734					

Seite Page	Artikel-Nr. Product No.	EAN-Nummer EAN-Number	Ersatzteile Spare parts
126	401100101	4017807276121	92782-01
126	401100102	4017807276138	92782-02
126	401100111	4017807505580	S4011-11
277	401200101	4017807502640	S3012-01
435	401600131	4017807489422	S4016-01
435	401600132	4017807489439	S4016-02
434	401700317	4017807502541	S4017-01 S4017-02 S4017-11 S4017-17
260	401900367	4017807502619	
168	402000108	4017807436099	G4020-01
167	402000132	4017807506426	G4020-01
167	402000142	4017807433012	G4020-54
264	402690167	4017807502688	
285	403000132	4017807468076	
254	403400167	4017807426854	
474	403400317	4017807422986	G40341-13 G40342-19 G40343-54
474	403400354	4017807422948	G40341-54 G40342-54 G40343-54
256	403490167	4017807430226	
471	4035011-04	4017807090604	92174
471	4035011-07	4017807090611	92174
471	4035011-08	4017807090628	92174
127	403900201	4017807433654	S40391-01 S40392-01
127	403900208	4017807494556	S40391-81 S40392-81
127	403900211	4017807433661	S40391-11 S40392-11
275	404300332	4017807467727	
468	404600332	4017807377361	
253	405500367	4017807466751	92988
148	406700632	4017807364415	
172	407690906	4017807423150	G5076-54
473	407800132	4017807303216	92784-02
150	407900332	4017807502695	
161	408000131	4017807407297	
161	408000132	4017807407303	
118	408200179	4017807392593	
119	408290179	4017807392616	
104	408300307	4017807510676	92981-07 92976-11
106	408300308	4017807510683	92981-08 92976-01
170	408500542	4017807468670	G40342-54
469	408800332	4017807390148	
266	409000167	4017807466843	
109	409100307	4017807389654	92865-07
109	409100308	4017807389661	92865-08
258	409500167	4017807488920	

Seite Page	Artikel-Nr. Product No.	EAN-Nummer EAN-Number	Ersatzteile Spare parts
175	411210406	4017807367836	92829-40 92833-10 92833-12 92833-14
112	411400132	4017807538618	
112	411400232	4017807538731	
110	411490132	4017807538687	
439	411700108	4017807522501	S4117-08
464	412400107	4017807488777	
464	412400108	4017807488760	
464	412400131	4017807488784	
464	412400132	4017807488791	
262	412700132	4017807502732	
162	413300107	4017807507416	
162	413300108	4017807507393	
162	413300132	4017807507409	
138	413900132	4017807505092	S3139-32 G3139-01
249	414300530	4017807538861	
422	414400107	4017807539448	S4144-01
422	414400108	4017807539455	S4144-01
422	414400132	4017807539486	S4144-01
424	415700307	4017807539929	S4157-01
424	415700332	4017807539950	S4157-01
433	416900207	4017807541724	S41691-07 S41692-07
433	416900208	4017807541717	S41691-08 S41692-08
527	411900231	4017807523041	
145	411900232	4017807523058	
438	4200011-06	4017807105650	913244 913240
467	420490107	4017807295337	9243-01
467	420490132	4017807382525	9243-01
459	420810107	4017807367614	
458	420910107	4017807367591	
458	420910108	4017807367607	
436	421100301	4017807194494	92287F-01 92287S-01
436	421100302	4017807194500	92287F-02 92287S-02
71	421210107	4017807454024	
71	421210108	4017807461169	
451	421910207	4017807267532	92685 92685-01 92754-01 92754
451	421910228	4017807267549	92685 92685-01 92754-01 92754
462	422410107	4017807358599	
462	422410108	4017807358605	
83	422610531	4017807423822	
83	422610532	4017807423853	

Seite Page	Artikel-Nr. Product No.	EAN-Nummer EAN-Number	Ersatzteile Spare parts	Seite Page	Artikel-Nr. Product No.	EAN-Nummer EAN-Number	Ersatzteile Spare parts
84	422610589	4017807497847		101	441610132	4017807542530	
443	422710307	4017807343076		69	441810205	4017807540765	
443	422710308	4017807354270		67	441810208	4017807541731	
426	422970206	4017807368260	92946 92821	57	451850101	4017807407464	92873IR
456	423310107	4017807505825		154	4602021-24	4017807196801	92274 92274-01
456	423310108	4017807506105		126	461100101	4017807247220	92597-01
456	423310132	4017807506099		126	461100102	4017807247237	92597-02
80	423410107	4017807506297		126	461100111	4017807508673	92597-11
80	423410131	4017807506310		437	462100132	4017807398922	S4621-02
80	423410132	4017807506327		454	470310104	4017807523348	
448	424210304	4017807467635		454	470310131	4017807523324	
448	424210307	4017807467628		454	470310132	4017807523331	
448	424210332	4017807467598		78	472910106	4017807299281	
444	424310204	4017807525199		466	473190307	4017807302691	
444	424310207	4017807525182		466	473190331	4017807302707	
444	424310208	4017807525205		466	473190332	4017807382532	
444	424310232	4017807525212		472	474410179	4017807359633	
79	424610132	4017807470833	D0246-32	460	474790107	4017807390087	
79	424610179	4017807470901	D0246-79	460	474790132	4017807390094	
470	424810107	4017807257687	98249 98248	428	475310307	4017807380439	92844-07
470	424810207	4017807257700	98249 98248	428	475310379	4017807380446	92844-79
453	424910207	4017807353938	92928	427	475410207	4017807398595	S4754-01
446	425610204	4017807525243		452	478310206	4017807336795	
446	425610207	4017807525229		431	500200107	4017807368406	92819
446	425610208	4017807525250		431	500200108	4017807378313	92819
446	425610232	4017807525267		165	500500104	4017807268669	
73	426219107	4017807505276		159	500700128	4017807354201	92809
73	426219131	4017807505252		154	501000224	4017807504729	G5010-01
73	426219132	4017807505269		129	501100101	4017807246810	
98	426410130	4017807505450		129	501100102	4017807246827	
450	426410207	4017807244717	92730	129	501100111	4017807505535	S5011-11
450	426410208	4017807244724	92730	276	501200101	4017807502657	S5012-01
64	426510104	4017807525342		168	502000108	4017807436075	G2020-01
64	426510107	4017807525335		166	502000132	4017807506402	G2020-01
64	426510108	4017807525359		166	502000142	4017807432992	G2020-54
64	426510142	4017807525366		278	502100130	4017807473476	S30212-01
62	426510204	4017807525281		496	5027011-01	4017807017366	
62	426510207	4017807525274		496	5027011-17	4017807051360	
62	426510208	4017807525298		496	5027011-47	4017807124941	
62	426510242	4017807525311		496	5028010-01	4017807051414	
440	426511832	4017807467390		496	5028010-02	4017807051421	
88	426810131	4017807506495		496	5028010-17	4017807051438	
88	426810132	4017807506501		496	5028010-47	4017807051445	
441	427511801	4017807274332	92777	497	5029010-01	4017807051377	
441	427511802	4017807274349	92777	497	5029010-47	4017807051407	
441	427511887	4017807279511	92777	275	504300132	4017807467703	
94	427710505	4017807451672		495	504900104	4017807522570	
94	427710532	4017807442205		495	504900107	4017807522556	
450	429110104	4017807267518	92694	495	504900131	4017807522518	
450	429110107	4017807267525	92694	495	504900132	4017807522532	
86	441210305	4017807540413		172	507690606	4017807423112	G5076-54
86	441210308	4017807540390		161	508000131	4017807407273	
				161	508000132	4017807407280	
				118	508200179	4017807392555	92999

Seite Page	Artikel-Nr. Product No.	EAN-Nummer EAN-Number	Ersatzteile Spare parts	Seite Page	Artikel-Nr. Product No.	EAN-Nummer EAN-Number	Ersatzteile Spare parts
494	508300131	4017807422313		88	526810131	4017807506488	
494	508300132	4017807422337		88	526810132	4017807506471	
292	508400132	4017807387438	G5040-02	492	527090111	4017807372328	
292	508400161	4017807387445	G5040-02	492	527090131	4017807372335	
292	508400162	4017807387452	G5040-02	493	527290101	4017807291438	
108	509100107	4017807398540	S5091-01	493	527290102	4017807291445	
108	509100108	4017807398557	S5091-01	488	527410142	4017807291513	
180	510600101	4017807504552	G0106-31	477	527590107	4017807371758	92825
180	510600132	4017807427240	G0106-54	477	527590132	4017807480313	92825
180	510600154	4017807507522	G0106-54	477	527590179	4017807373103	92825
129	511100101	4017807246841	92807-01	489	527690131	4017807372304	
129	511100102	4017807246858	92807-02	489	527690132	4017807372311	
129	511100111	4017807508710		94	527710305	4017807451665	
174	511210306	4017807367829	92829-28 92833-10 92833-12	94	527710332	4017807442229	
110	511400132	4017807538755		486	527920101	4017807276046	
527	511900131	4017807523072		486	527920102	4017807276053	
145	511900132	4017807523089		478	529690100	4017807262032	92671-00
280	512200136	4017807544831		478	529690107	4017807262070	92671-07
464	512400107	4017807488746		479	529990103	4017807248340	92584
464	512400108	4017807488753		479	529990107	4017807248364	92584
464	512400131	4017807488722		86	541210205	4017807540284	
464	512400132	4017807488739		86	541210208	4017807540253	
249	514300230	4017807538885		101	541610132	4017807542493	
422	514400107	4017807539301	S5144-01	69	541810205	4017807541748	
422	514400108	4017807539370	S5144-01	67	541810208	4017807541762	
422	514400132	4017807539400	S5144-01	454	570310104	4017807523294	
176	515190132	4017807539707	G5151-57	454	570310131	4017807523256	
424	515700107	4017807539882	S5157-01	454	570310132	4017807523270	
424	515700132	4017807539905	S5157-01	462	572410107	4017807337006	
424	515790107	4017807554977	S51571-01	462	572410108	4017807345162	
424	515790132	4017807554991	S51571-01	78	572910106	4017807303162	
458	520910107	4017807367577		505	573190107	4017807302677	
458	520910108	4017807367584		505	573190131	4017807302684	
71	521210107	4017807454017		492	573910101	4017807275636	92839
71	521210108	4017807461152					92998
488	522520102	4017807226775		492	573910106	4017807275650	92839
488	522520187	4017807226782		472	574410179	4017807359626	
82	522610331	4017807423792		428	575310307	4017807380453	
82	522610332	4017807423815		428	575310379	4017807380460	
84	522610389	4017807497823		427	575410207	4017807398588	S5754-01
487	523090131	4017807502503		490	579790104	4017807275285	
487	523090132	4017807502527		490	579790107	4017807275322	
456	523310107	4017807505771		490	579790108	4017807275339	
456	523310108	4017807505818		490	579790132	4017807452549	
456	523310132	4017807505801		483	590100107	4017807551129	9424
480	525490106	4017807371710	92826	483	590100132	4017807551136	9424
480	525490107	4017807371727	92826	482	590200107	4017807551143	9426
478	525790107	4017807385663	92876	482	590200132	4017807551150	9426
478	525790108	4017807385670	92876	482	591000107	4017807551167	9262-01
62	526510104	4017807525373		482	591000132	4017807551174	9262-01
62	526510107	4017807510140		485	591600101	4017807551181	92281-01
62	526510108	4017807510157		485	591600102	4017807551198	92281
62	526510142	4017807510164		485	591600142	4017807551204	92281-42
				476	592300107	4017807551211	9309
				476	592600107	4017807551228	9321

Seite Page	Artikel-Nr. Product No.	EAN-Nummer EAN-Number	Ersatzteile Spare parts	Seite Page	Artikel-Nr. Product No.	EAN-Nummer EAN-Number	Ersatzteile Spare parts
476	592600108	4017807551235	9321	124	603900502	4017807369304	92631-65
162	593400107	4017807551242		124	603900511	4017807505634	S60393-11
162	593400108	4017807551259					92631-65
162	593400132	4017807551266		184	604400101	4017807364996	92830-30
116	595400101	4017807337778	93781	184	604400201	4017807365009	92830-40
116	595400111	4017807337785	93781-11	184	604400301	4017807365016	92830-50
116	595400141	4017807391046	93781-41	342	604900331	4017807454284	
116	595400179	4017807337792	93781-79	342	604900332	4017807454307	
116	595400189	4017807337808	93781-89	342	604900631	4017807454345	
480	595700106	4017807551273	9610-01	342	604900632	4017807454369	
480	595700107	4017807551280	9610-00	116	605400501	4017807349214	93781
480	595700108	4017807551297	9610-00	116	605400511	4017807349221	93781-11
481	599100106	4017807551303	92271-06	116	605400541	4017807391039	
481	599100107	4017807551310	92271-07	116	605400579	4017807349238	
481	599100108	4017807551327	92271-07	116	605400589	4017807349245	93781-89
481	599100118	4017807551334	92271-18	252	605500467	4017807442588	92987
481	599100124	4017807551341	92271-07	371	605600307	4017807236996	92529
484	599700101	4017807551358	92934-01	371	605600507	4017807237009	92529
484	599700115	4017807551365		148	606700632	4017807373448	
484	599700119	4017807551372		291	606900132	4017807504170	
484	599700142	4017807551389		291	606900161	4017807351781	
409	600400100	4017807398656	92856	291	606900162	4017807356823	
409	600400200	4017807398663	92857	291	606903032	4017807512069	
178	600600331	4017807467352	G30062-52	291	606903062	4017807517644	
178	600600342	4017807467369	G30062-54	291	606905032	4017807512038	
158	600700328	4017807354225	92809	291	606905062	4017807517668	
152	601000324	4017807504699	G1010-01	172	607601206	4017807426885	G50761-54
188	601200100	4017807398601	92851	190	607800100	4017807189216	92259-30
276	601200101	4017807502664	S3012-01	160	608000331	4017807412598	
188	601200200	4017807398618	92852	160	608000332	4017807412604	
260	601900467	4017807502596		372	608100224	4017807211795	92472-01
278	602100130	4017807491500	S30211-01	372	608100324	4017807211788	92472
370	602300301	4017807399578	S60232-01	118	608200279	4017807392531	
			96023-40	104	608300307	4017807510652	92980-01
370	602300345	4017807399585	S60232-45				92985-07
			96023-40				92978-11
370	602300394	4017807399592	S60232-94	106	608300308	4017807510669	92980-01
			96023-40				92985-08
408	602400106	4017807244915	92579-25				92978-01
408	602400206	4017807244922	92579-30	186	608700189	4017807385434	92921-89
189	602500101	4017807364941	92831-30	186	608700289	4017807385458	92922-89
189	602500201	4017807364958	92831-40	130	608900331	4017807413717	C0089-01
410	603300101	4017807433784		130	608900342	4017807425475	C0089-01
134	603500331	4017807422047		120	609400317	4017807423730	
134	603500332	4017807422054		132	609800431	4017807387704	92887
124	603900201	4017807289688	92631-30	132	609800432	4017807387711	92887
124	603900202	4017807289695	92631-30	142	609900331	4017807330960	92943-01
124	603900211	4017807505603	S60391-11	142	609900332	4017807330984	92943
124	603900301	4017807256536	92662	407	6101011-01	4017807017557	9218-01
			92631	407	6101011-07	4017807028393	9218-01
124	603900302	4017807256543	92662-02	154	6102021-24	4017807053296	92126
			92631	156	610300428	4017807369175	
124	603900311	4017807505627	S60392-11	406	6105011-01	4017807053968	9285-01
			92631	406	6105021-01	4017807098440	9287-01
124	603900501	4017807369298	92631-65	140	611100308	4017807537789	

Seite Page	Artikel-Nr. Product No.	EAN-Nummer EAN-Number	Ersatzteile Spare parts	Seite Page	Artikel-Nr. Product No.	EAN-Nummer EAN-Number	Ersatzteile Spare parts
140	611100367	4017807537642		90	620310332	4017807487886	
174	611210506	4017807367782	92829-40 92833-10 92833-12 92833-14	325	620510307	4017807488586	D62051-52
				325	620510331	4017807488579	D62051-52
				325	620510332	4017807488562	D62051-52
114	611400332	4017807538700		70	621210107	4017807453980	
112	611400532	4017807544572		70	621210108	4017807461121	
112	611490332	4017807544565		70	621290107	4017807453997	
374	611500201	4017807526158	S61152-01	70	621290108	4017807461138	
374	611500202	4017807526165	S61152-02	503	621410505	4017807220940	92426 92389-05
374	611500301	4017807526202	S61153-01	77	621710107	4017807430509	
374	611500302	4017807526219	S61153-02	77	621710142	4017807430516	
146	611900632	4017807536584		348	621910301	4017807503975	S6219-01
182	612200100	4017807522037	G61221-52	348	621910302	4017807503999	S6219-02
182	612200200	4017807522051	G61222-52	348	621910317	4017807504019	S6219-01 S6219-02 S6219-11
280	612200336	4017807544824		348	621910501	4017807504026	S6219-01
284	612300236	4017807504637	S6123-36	348	621910502	4017807504033	S6219-02
512	612400501	4017807411614		348	621910517	4017807504064	S6219-01 S6219-02 S6219-11
515	612400504	4017807490619					
515	612400507	4017807411638		346	621911201	4017807337105	
512	612400532	4017807411621		346	621911211	4017807337112	
510	612400580	4017807523980		346	621912401	4017807337143	92962
376	612600230	4017807526325	G6126-01	346	621912411	4017807337150	92962
376	612600256	4017807526585	G6126-01	347	621914001	4017807384468	92883IR
344	612900131	4017807426441		347	621914011	4017807384475	92883IR
344	612900132	4017807426465		347	621915501	4017807384482	92883IR
344	612900231	4017807426526		347	621915511	4017807384499	92883IR
344	612900232	4017807426533		82	622610431	4017807424270	
344	612900431	4017807426588		82	622610432	4017807424287	
344	612900432	4017807426595		84	622610489	4017807497786	
345	613000131	4017807426908		82	622610531	4017807488821	
345	613000132	4017807426915		82	622610532	4017807488838	
345	613000231	4017807426922		84	622610589	4017807497861	
345	613000232	4017807426939		373	622811528	4017807262407	92686
345	613000431	4017807426977		96	622910332	4017807524994	
345	613000432	4017807426984		96	622910532	4017807524987	
249	614300430	4017807538939		80	623410207	4017807506235	92969RD
176	615190132	4017807539660	G5151-57	80	623410231	4017807506242	92969RD
282	615900232	4017807540321		80	623410232	4017807506259	92969RD
282	615900242	4017807540338		80	623419207	4017807506266	92969RD
406	6160011-00	4017807131895	9516	80	623419231	4017807506273	92969RD
273	616500432	4017807540635		80	623419232	4017807506280	92969RD
351	616700306	4017807541687	G61671-57 B61671-00	251	623710130	4017807451184	
351	616700506	4017807541700	G61672-57 B61672-00	329	623810431	4017807399806	
407	6196011-01	4017807138238	9523-01	379	624110279	4017807337051	92795
407	6196011-07	4017807138245	9523-07	76	625010105	4017807422641	
314	620010407	4017807449525		76	625010132	4017807422658	
314	620010408	4017807550788		358	625815031	4017807506457	92970RD
314	620010431	4017807452204		72	626210107	4017807505191	
314	620010442	4017807449495		72	626210131	4017807505177	
90	620310307	4017807487862		72	626210132	4017807505184	
90	620310308	4017807487893		99	626410530	4017807505429	92967RD
90	620310331	4017807487879					

Seite Page	Artikel-Nr. Product No.	EAN-Nummer EAN-Number	Ersatzteile Spare parts	Seite Page	Artikel-Nr. Product No.	EAN-Nummer EAN-Number	Ersatzteile Spare parts
62	626510304	4017807538144		304	642110432	4017807541885	
62	626510307	4017807538083		300	642910280	4017807542974	
62	626510308	4017807538120		300	642910380	4017807542998	
62	626510342	4017807538168		568	650000106	4017807376210	
368	626510987	4017807245202		568	650000107	4017807376234	
368	626511287	4017807245226		568	650000108	4017807376241	
368	626512587	4017807246803		568	650000131	4017807376203	
102	626610207	4017807505481		568	650000132	4017807378061	
102	626610232	4017807505498		568	650000306	4017807376258	
310	626710531	4017807505719		568	650000307	4017807376265	
310	626710532	4017807505726		568	650000331	4017807376272	
310	626710587	4017807505733		568	650100106	4017807376302	
326	626910307	4017807506587	92996RD	568	650100107	4017807376319	
326	626910332	4017807506594	92996RD	568	650100108	4017807376326	
326	626919307	4017807506600	92996RD	568	650100131	4017807376296	
326	626919332	4017807506617	92996RD	568	650100132	4017807378078	
332	627413031	4017807525007		568	650100306	4017807376333	
332	627413032	4017807525014		568	650100307	4017807376340	
332	627413087	4017807525021		568	650100331	4017807376357	
332	627415031	4017807525038		564	650210106	4017807376388	
332	627415032	4017807525069		564	650210107	4017807376395	
332	627415087	4017807525076		564	650210131	4017807376371	
332	627417531	4017807525083		564	650210306	4017807376418	
332	627417532	4017807525090		564	650210307	4017807376425	
332	627417587	4017807525106		564	650210331	4017807376432	
366	627514000	4017807401837	6289IR-2	564	650310106	4017807376463	
366	627516000	4017807401820	6289IR-2	564	650310107	4017807376470	
94	627710405	4017807451702		564	650310131	4017807376456	
94	627710432	4017807442182		564	650310306	4017807376494	
94	627710505	4017807451658		564	650310307	4017807376500	
94	627710532	4017807448184		564	650310331	4017807376517	
319	628410507	4017807504071	92975RD	560	650410106	4017807376630	
319	628410532	4017807504040	92975RD	560	650410107	4017807376647	
364	628513001	4017807298819	6289IR-2	560	650410131	4017807376623	
364	628613001	4017807298826	6289IR-2	560	650410132	4017807378030	
362	628915001	4017807272307	6289IR-2 6289IR	560	650510106	4017807376753	
				560	650510107	4017807376760	
308	629010107	4017807423426		560	650510131	4017807376722	
356	629210331	4017807525113	93000RD	560	650510132	4017807378085	
356	629219331	4017807525120	93000RD	562	650610106	4017807376869	
136	640910131	4017807537901		562	650610107	4017807376876	
137	640910132	4017807537925		562	650610131	4017807376890	
86	641210305	4017807539936		562	650610132	4017807442595	
86	641210308	4017807539912		562	650610306	4017807376906	
352	641412106	4017807539288	G6414-57	562	650610307	4017807376913	
352	641412107	4017807539226	G6414-01	562	650610331	4017807376920	
352	641412132	4017807539257	G6414-01	562	650710106	4017807376937	
100	641610232	4017807542431		562	650710107	4017807376944	
68	641810205	4017807540741		562	650710131	4017807376951	
66	641810208	4017807540758		562	650710132	4017807442601	
298	641910205	4017807541939		562	650710306	4017807376975	
298	641910208	4017807541953		562	650710307	4017807376968	
304	642110331	4017807541830		562	650710331	4017807376982	
304	642110332	4017807541816		50	651110207	4017807425291	92873IR
304	642110431	4017807541908		50	651110232	4017807425314	92873IR

Seite Page	Artikel-Nr. Product No.	EAN-Nummer EAN-Number	Ersatzteile Spare parts
51	651210507	4017807389753	92873IR
570	651500131	4017807455915	
570	651500132	4017807455939	
570	651600131	4017807455946	
570	651600132	4017807455977	
570	651600231	4017807456011	
570	651600232	4017807455991	
570	651600331	4017807456035	
570	651600332	4017807456059	
566	651700152	4017807425888	
566	651800152	4017807425901	
54	651914001	4017807389609	92873IR
54	651915501	4017807389616	92873IR
566	652100152	4017807425925	
566	652200152	4017807425949	
556	652310106	4017807427660	
556	652310131	4017807427677	
556	652310132	4017807504095	
556	652410106	4017807427684	
556	652410131	4017807427691	
556	652410132	4017807504101	
558	652510106	4017807427707	
558	652510131	4017807427714	
558	652510132	4017807504132	
558	652610106	4017807427721	
558	652610131	4017807427738	
558	652610132	4017807504156	
48	652610307	4017807453881	92873IR
48	652610342	4017807453751	92873IR
48	652690307	4017807453898	92873IR
48	652690342	4017807453768	
46	652710307	4017807453799	92873IR
46	652710342	4017807473339	92873IR
500	652910131	4017807473643	
500	652910132	4017807473650	
500	652910231	4017807473667	
500	652910232	4017807473674	
500	652910331	4017807473681	
500	652910332	4017807473698	
56	656010100	4017807389845	92873IR
56	656090100	4017807389869	92873IR
369	656411506	4017807371796	
369	656412406	4017807371802	
369	656511806	4017807371826	
369	656512006	4017807371833	
341	657010601	4017807294637	92840-12
341	657010607	4017807294675	92840-12
341	657011201	4017807294712	92840-18
341	657011207	4017807294729	92840-18
341	657011801	4017807294743	92840-22
341	657011807	4017807294750	92840-22
340	657110601	4017807294651	92840-12
340	657110607	4017807294668	92840-12
340	657111201	4017807294705	92840-18
340	657111207	4017807294699	92840-18

Seite Page	Artikel-Nr. Product No.	EAN-Nummer EAN-Number	Ersatzteile Spare parts
340	657111801	4017807294767	92840-22
340	657111807	4017807294774	92840-22
53	657411107	4017807436358	92873IR
52	657413007	4017807436341	92873IR
53	657414007	4017807434521	92873IR
53	657416007	4017807434552	92873IR
52	657493007	4017807436334	92873IR
52	657494007	4017807434415	92873IR
52	657496007	4017807434439	92873IR
578	659011801	4017807280081	
578	659011806	4017807508413	
578	659011832	4017807508406	
578	659011887	4017807280098	
602	659411806	4017807280050	
602	659412406	4017807280074	
316	670710507	4017807503470	92975RD
316	670710532	4017807503456	92975RD
317	670810607	4017807503531	92975RD
317	670810632	4017807503524	92975RD
338	671210131	4017807489835	
338	671210132	4017807489842	
339	671290131	4017807489859	92960RD
339	671290132	4017807489866	92960RD
74	671310105	4017807445329	
74	671310131	4017807451832	
74	671310142	4017807445312	
308	671610307	4017807391237	
308	671610331	4017807391244	
311	672110505	4017807503982	
311	672110542	4017807503951	
309	672310207	4017807503371	92966RD
309	672310231	4017807503333	92966RD
309	672310232	4017807503357	92966RD
313	672610332	4017807441208	
331	672810202	4017807503166	
331	672819202	4017807503173	
78	672910106	4017807299274	
312	673210306	4017807388411	
312	673210331	4017807388428	
312	673210332	4017807441192	
355	673311306	4017807358407	92912IR
302	673810206	4017807433333	
302	673810232	4017807433364	
303	673810306	4017807505689	
303	673810332	4017807505702	
302	673890206	4017807433371	
302	673890232	4017807433388	
306	673916007	4017807452594	
306	673916031	4017807452235	
306	673916032	4017807441437	
306	673918007	4017807452617	
306	673918031	4017807452259	
306	673918032	4017807441468	
337	674011207	4017807363708	
335	674011232	4017807556315	

Seite Page	Artikel-Nr. Product No.	EAN-Nummer EAN-Number	Ersatzteile Spare parts	Seite Page	Artikel-Nr. Product No.	EAN-Nummer EAN-Number	Ersatzteile Spare parts
336	674013007	4017807363630		601	680214800	4017807508482	92930-48
334	674013032	4017807556322					92974IR
337	674014507	4017807363654		603	680310106	4017807508437	
335	674014532	4017807556339		603	680310132	4017807508444	
337	674016207	4017807363692		603	680319106	4017807508451	
335	674016232	4017807556346		603	680319132	4017807508468	
336	674093007	4017807363623		598	680710106	4017807507843	
334	674093032	4017807556353		598	680710131	4017807507867	
336	674094507	4017807363647		598	680710132	4017807507881	
334	674094532	4017807556360		574	680810306	4017807508505	
336	674096207	4017807363685		574	680810332	4017807508512	
334	674096232	4017807556377		574	680819306	4017807508529	
324	674410307	4017807455854		574	680819332	4017807508536	
324	674410331	4017807477108		576	682410506	4017807280845	
324	674410342	4017807455847		600	686014000	4017807507744	E6260-00
359	674510107	4017807381566	6587IR	600	686014001	4017807507720	E6260-00
320	674610507	4017807385786		577	686412406	4017807507805	
320	674610707	4017807450224		577	686512406	4017807507829	
92	675510507	4017807455779		599	689214032	4017807507768	
92	675510532	4017807455762		599	689314032	4017807507782	
363	675610106	4017807363302	92870RD 6289IR-2 6787IR 92863-241	122	693900417	4017807409451	S693915-11 S693920-02 S693925-01 S693930-01 96939-15
323	676210307	4017807371918		122	693900517	4017807399547	S693920-11 S693925-02 S693930-02 S693935-01 S693940-01
323	676210342	4017807425703					
323	676210407	4017807425734					
323	676210442	4017807425758					
322	676240306	4017807524871					
322	676240331	4017807524901					
322	676240406	4017807524925		536	700131	4017807470161	
322	676240431	4017807524949		536	700132	4017807470178	
328	676611031	4017807398533	92868RD	536	700187	4017807470246	
328	676615031	4017807398519	92868RD	536	700231	4017807470277	
328	676617531	4017807398526	92868RD	536	700232	4017807470307	
367	677718000	4017807337686	92804 6289IR-2	536	700287	4017807470253	
362	678513001	4017807431070	6289IR-2	536	701031	4017807470321	
360	678710006	4017807337730	6289IR-2 6787IR 92864	536	701032	4017807470338	
360	678711206	4017807337716		536	701087	4017807470345	
360	678713006	4017807337723	6787IR 6289IR-2	536	701131	4017807474824	
361	679110032	4017807471069	6289IR-2	536	701132	4017807474831	
361	679112132	4017807471021		536	701187	4017807474848	
361	679114232	4017807471045	6289IR-2	543	701231	4017807470352	
365	679210106	4017807440348	6289IR-2	543	701232	4017807470369	
354	679511532	4017807450767		543	701287	4017807470376	
605	6801011-01	4017807259056		539	702031	4017807470383	
605	6801011-06	4017807147575	9580	539	702032	4017807470390	
605	6801011-07	4017807147582	9580	539	702087	4017807470406	
605	6801011-32	4017807507690		539	702131	4017807470475	
601	680213500	4017807508475	92930-35 92974IR	539	702132	4017807470482	
				539	702187	4017807470499	
				539	702231	4017807470505	
				539	702231A	4017807474855	
				539	702232	4017807470543	
				539	702232A	4017807474862	

Seite Page	Artikel-Nr. Product No.	EAN-Nummer EAN-Number	Ersatzteile Spare parts	Seite Page	Artikel-Nr. Product No.	EAN-Nummer EAN-Number	Ersatzteile Spare parts
539	702287	4017807470550		550	76921587	4017807506013	
539	702287A	4017807474879		550	77020131	4017807472028	
541	702331	4017807470567		550	77020132	4017807472035	
541	702331A	4017807482171		550	77020187	4017807472042	
541	702331B	4017807518900		548	78010107	4017807471946	
541	702332	4017807470574		548	78010131	4017807471922	
541	702332A	4017807482188		548	78010132	4017807471939	
541	702332B	4017807518924		544	78030131	4017807505900	
541	702387	4017807470581		544	78030132	4017807505917	
541	702387A	4017807482195		544	78030187	4017807505924	
541	702387B	4017807518948		544	78070107	4017807472073	
541	702431	4017807470598		544	78070131	4017807472080	
541	702432	4017807470604		544	78070132	4017807472103	
541	702487	4017807470611		544	78150107	4017807505894	
542	702531	4017807470628		544	78150131	4017807505870	
542	702532	4017807470635		544	78150132	4017807505887	
542	702587	4017807470642		548	78170107	4017807471663	
542	703031	4017807471397		546	78240107	4017807471694	
542	703032	4017807471403		546	78240108	4017807542660	
542	703087	4017807471410		546	78240131	4017807471700	
542	703131	4017807471427		546	78240132	4017807471724	
542	703132	4017807471434		552	78330101	4017807471977	
542	703187	4017807471441		552	78330111	4017807471991	
542	703231	4017807471458		552	78330179	4017807472295	
542	703232	4017807471465		548	78430132	4017807506020	
542	703287	4017807471472		525	800300132	4017807351392	
543	703331	4017807471489		525	800300232	4017807351415	
543	703332	4017807471502		525	800300432	4017807351644	
543	703387	4017807471519		508	800700107	4017807469103	
543	703431	4017807474886		508	800700131	4017807469127	
543	703531	4017807474893		508	800700132	4017807469141	
543	703532	4017807474909		508	800700207	4017807469165	
543	703587	4017807474916		508	800700231	4017807469202	
543	703952	4017807471533		508	800700232	4017807469226	
547	73043107	4017807505955		508	800700307	4017807469264	
547	73043131	4017807505931		508	800700331	4017807469288	
547	73043132	4017807505948		508	800700332	4017807469301	
552	73120102	4017807471557		508	800700407	4017807469325	
546	73240107	4017807471564		508	800700431	4017807469349	
546	73240108	4017807542684		508	800700432	4017807469363	
546	73240131	4017807471571		260	801900167	4017807502558	
546	73240132	4017807471588		260	801900267	4017807502565	
552	73330101	4017807471595		260	801900367	4017807502589	
552	73330111	4017807471618	92989-11	512	802400101	4017807227543	
548	73430132	4017807506037		514	802400104	4017807490534	
548	73520101	4017807471656		514	802400107	4017807231335	
553	73820180	4017807505856		512	802400124	4017807408621	
552	76390201	4017807472110		512	802400132	4017807408614	
552	76390211	4017807472127		510	802400180	4017807523898	
553	76820280	4017807505832		512	802400201	4017807227550	
550	76921031	4017807505962		514	802400204	4017807490558	
550	76921032	4017807505979		514	802400207	4017807231359	
550	76921087	4017807505986		512	802400224	4017807408645	
550	76921531	4017807505993		512	802400232	4017807408638	
550	76921532	4017807506006		510	802400280	4017807523911	

Seite Page	Artikel-Nr. Product No.	EAN-Nummer EAN-Number	Ersatzteile Spare parts
512	802400301	4017807227567	
514	802400304	4017807490572	
514	802400307	4017807231373	
512	802400324	4017807408669	
512	802400332	4017807408652	
510	802400380	4017807523935	
513	802430401	4017807227574	
515	802430404	4017807490596	
515	802430407	4017807231397	
513	802430424	4017807408683	
513	802430432	4017807408676	
510	802430480	4017807523959	
524	802500178	4017807299519	
524	802500278	4017807299526	
524	802500378	4017807299540	
522	803000107	4017807348262	
522	803000207	4017807348279	
523	803000307	4017807348286	
523	803090307	4017807348323	
256	803400167	4017807430196	
256	803400267	4017807430202	
256	803400367	4017807430219	
506	803500131	4017807408201	S8035-02
506	803500132	4017807408225	S8035-02
506	803500231	4017807408232	S8035-02
506	803500232	4017807408249	S8035-02
506	803500331	4017807408256	S8035-02
506	803500332	4017807408263	S8035-02
506	803590431	4017807408294	S8035-02
506	803590432	4017807408300	S8035-02
274	804300332	4017807467666	
274	804300432	4017807467680	
274	804370132	4017807467604	
274	804370232	4017807467642	
268	805300188	4017807445183	
268	805300288	4017807445190	
268	805300388	4017807445206	
268	805300488	4017807445213	
114	811400132	4017807538335	
114	811400232	4017807538359	
114	811400432	4017807538397	
114	811430332	4017807538373	
526	811900131	4017807522815	
146	811900132	4017807522792	
526	811900231	4017807522860	
146	811900232	4017807522877	
526	811900331	4017807522921	
146	811900332	4017807522938	
516	812400107	4017807487947	
516	812400131	4017807487961	
516	812400132	4017807487954	
516	812400207	4017807487978	
516	812400231	4017807487992	
516	812400232	4017807487985	
516	812400307	4017807488005	

Seite Page	Artikel-Nr. Product No.	EAN-Nummer EAN-Number	Ersatzteile Spare parts
516	812400331	4017807488029	
516	812400332	4017807488012	
516	812400407	4017807488036	
516	812400431	4017807488067	
516	812400432	4017807488043	
528	813400127	4017807540789	
528	813400227	4017807540833	
528	813400427	4017807540857	
528	813430327	4017807540864	
503	821410305	4017807220902	92426 92426-35 959-745 92389-02
502	821410405	4017807220919	92426 92426-35 959-745 92389-03
502	821410605	4017807220933	92426 92426-35 959-745 92389-04
503	821430405	4017807220926	92426 92426-35 959-745
503	821470105	4017807220889	92426 92426-35 959-745 92389
502	821470205	4017807220896	92426 92426-35 92389-01
520	871010107	4017807281637	92734 92910
520	871010108	4017807281644	92734 92910
520	871010207	4017807281651	92734 92910
520	871010208	4017807281668	92734 92910
520	871010307	4017807281675	92734 92910
520	871010308	4017807281682	92734 92910
520	871010407	4017807281712	92734 92910
520	871010408	4017807281729	92734 92910
520	871010607	4017807281736	92734 92910
520	871010608	4017807281743	92734 92910
521	871090307	4017807281699	92734 92910
521	871090308	4017807281705	92734 92910

Seite Page	Artikel-Nr. Product No.	EAN-Nummer EAN-Number	Ersatzteile Spare parts
518	871510207	4017807284904	92739
518	871510407	4017807284966	92739
519	871510607	4017807284980	92739
518	871570107	4017807284898	92739
518	871590307	4017807284942	92739
504	873110307	4017807302615	
504	873110331	4017807302622	
505	873110407	4017807302639	
505	873110431	4017807302646	
505	873110607	4017807302653	
505	873110631	4017807302660	
504	873170107	4017807302578	
504	873170131	4017807302585	
504	873170207	4017807302592	
504	873170231	4017807302608	
594	880400106	4017807508031	
594	880400132	4017807508048	
594	880400406	4017807508383	
594	880400432	4017807508390	
594	880430306	4017807508369	
594	880430332	4017807508376	
413	891010107	4017807358049	92734
412	8911211-07	4017807118780	9568-07
413	891770107	4017807358162	92816
412	899670107	4017807358155	
271	92945	4017807478174	
611	901-479	4017807351446	
611	902-479	4017807351453	
611	903-479	4017807351460	
611	904-479	4017807351477	
614	929-220	4017807293319	
614	929-230	4017807355000	
614	929-2300	4017807394924	
615	955-50	4017807277074	
614	955-55	4017807277098	
615	956-30	4017807277050	
615	956-330	4017807509151	
615	956-355	4017807509144	
615	956-509	4017807508987	
615	956-55	4017807300369	
615	956-5736	4017807380057	
615	956-5936	4017807380071	
613	983-200	4017807508840	
613	983-279	4017807508857	
614	983-3200	4017807508901	
614	983-3279	4017807508932	
614	983-3400	4017807543155	
612	983-40	4017807240566	
613	983-400	4017807302097	
613	983-410	4017807394900	
612	983-43	4017807260540	
613	983-4470	4017807358940	
613	983-479	4017807530612	
613	983-4790	4017807509137	
612	983-509	4017807508963	

Seite Page	Artikel-Nr. Product No.	EAN-Nummer EAN-Number	Ersatzteile Spare parts
612	983-56	4017807394863	
612	983-60	4017807279214	
612	983-63	4017807279221	
612	983-66	4017807300345	
609	985-6810	4017807358759	
608	986-40	4017807268782	
608	986-43	4017807268799	
608	986-60	4017807280647	
608	986-63	4017807280654	
610	986-6790	4017807509120	
610	986-6810	4017807358766	
610	986-710	4017807433463	
609	987-2400	4017807303933	
609	987-2479	4017807509113	
608	987-260	4017807509090	
608	987-400	4017807287509	
609	987-410	4017807394917	
609	987-479	4017807509106	
608	987-60	4017807279252	
610	987-600	4017807288056	
609	987-6700	4017807387636	
610	987-679	4017807288049	
608	987-6810	4017807358735	
608	987-7009	4017807508949	
608	987-909	4017807508956	
608	988-10	4017807300338	
608	988-110	4017807394894	
609	988-600	4017807287516	
610	988-679	4017807287530	
608	988-700	4017807394887	
610	988-710	4017807433449	
613	989-200	4017807508864	
613	989-279	4017807508871	
613	989-3200	4017807508918	
613	989-3279	4017807508925	
613	989-3400	4017807543162	
612	989-40	4017807240597	
613	989-400	4017807287486	
612	989-43	4017807260557	
613	989-4470	4017807358926	
613	989-479	4017807287523	
613	989-4790	4017807509083	
612	989-509	4017807508970	
612	989-56	4017807394870	
612	989-60	4017807279238	
612	989-63	4017807279245	
612	989-66	4017807300352	
613	990-200	4017807508895	
613	990-279	4017807508888	
612	990-40	4017807240610	
613	990-400	4017807287493	
613	990-4470	4017807358933	
613	990-4790	4017807509076	

KONTAKTE

Contact · Contact · Contact · Contactar · Contatto · Contact · Yhteydenotto · Kontakt

TRIO Leuchten GmbH

Gut Nierhof 17
D-59757 Arnsberg

T +49 (0) 2931 9666-0

F +49 (0) 2931 9666-57

info@trio-leuchten.de

www.trio-leuchten.de

BADEN WÜRTTEMBERG, RHEINLAND-PFALZ UND SAARLAND

Antonio De Simone

T +49 (0) 151 5855222

antonio.desimone@trio-leuchten.de

ÖSTERREICH

Wolfgang Melich

T +43 (0) 6605161228

wolfgang.melich@trio-leuchten.de

BAYERN, HESSEN

Martin Kluge

T +49 (0) 171 7300330

martin.kluge@trio-leuchten.de

SCHWEIZ

TRIO Leuchten

T +49 (0) 2931 9666-0

info@trio-leuchten.de

BERLIN, BRANDENBURG, MECKLENBURG-VORPOMMERN, SACHSEN, SACHSEN ANHALT, THÜRINGEN

Jörg Bumke

T +49 (0) 160 7406860

joerg.bumke@trio-leuchten.de

BREMEN, HAMBURG, NIEDERSACHSEN, SCHLESWIG-HOLSTEIN

Jens Gebers

T +49 (0) 170 1615227

jens.gebers@trio-leuchten.de

NORDRHEIN-WESTFALEN

Christian Teller

T +49 (0) 171 4521820

christian.teller@trio-leuchten.de

 @trioleuchten

 /trioleuchten

 @trio.lighting



TRIO International GmbH

Gut Nierhof 17
D-59757 Arnsberg

T +49 (0) 2931 9666-587

F +49 (0) 2931 9666-56

info@trio-lighting.com

www.trio-lighting.com

FRANCE

Stéphane Papierny

Directeur Commercial France
info.france@trio-lighting.com

Sullivan Nicolas

info.france@trio-lighting.com
Agent exclusif pour les départements
01, 03, 07, 21, 26, 38, 39, 42,
43, 48, 63, 69, 71, 73 et 74

Vincent Zaepffel

info.france@trio-lighting.com
Commercial pour les départements
02, 08, 10, 25, 51, 52, 54, 55, 57, 59, 62,
67, 68, 70, 80, 88 et 90

Christophe Meulien

info.france@trio-lighting.com
Agent exclusif pour les départements
04, 05, 06, 11, 13, 30, 34, 66, 83 et 84

Jean Barel

info.france@trio-lighting.com
Agent exclusif pour les départements
09, 12, 15, 16, 19, 23, 24, 31, 32, 33, 40,
46, 47, 64, 65, 81, 82 et 87

Michel Salamand

info.france@trio-lighting.com
Agent exclusif pour les départements
14, 17, 22, 29, 35, 36, 37, 41, 44, 49, 50,
53, 56, 61, 72, 79, 85 et 86

Stéphane Riebel

info.france@trio-lighting.com
Agent exclusif pour les départements
18, 45, 58, 75 Sud, 77, 78, 89, 91 et 94

Elsa Seron

info.france@trio-lighting.com
Agent exclusif pour les départements
27, 28 et 76

Jean Philippe Bailly

info.france@trio-lighting.com
Agent exclusif pour les départements
60, 75 Nord, 92, 93 et 95

DANMARK

Jan Rantzau-Bartens

info.denmark@trio-lighting.com

SUOMI

TRIO Lighting Scandinavia Oy

Malmin raitti, rappu 17 B
00700 Helsinki
T +358 (0) 10 23 13 390
F +358 (0) 10 23 13 399
info.scandinavia@trio-lighting.com

*Our Scandinavian organisation represents TRIO
also in Sweden, Norway, Estonia, Latvia
and Lithuania*

ITALIA

TRIO Lighting Italia s.r.l

Via Dosso Fauti, 3
22066 Mariano Comense (CO)
T +39 (0) 317 477 55
F +39 (0) 313 551 560
info.italia@trio-lighting.com

ESPAÑA

TRIO Lighting Ibèrica SL

C/ Can Lietget nº9 nave 9
Pol. Ind. Can Roqueta
08206 Sabadell
T +34 (0) 9 35 45 86 30
F +34 (0) 9 33 96 45 48
info.iberica@trio-lighting.com

GREAT BRITAIN

TRIO Lighting UK Ltd.

Unit 5, Hemmells Park Hemmells, Laindon
Essex
SS1s 6GF
T +44 (0) 12 68 88 95 95
F +44 (0) 12 68 88 95 96
sales@trio-lightinguk.com

NEDERLAND

Karl Stok / Bas Martin

info.nederland@trio-lighting.com

BELGIUM/BELGIQUE

Yves van den Berghe

info.belgium@trio-lighting.com

ROMANIA

Gina Ionita

info.romania@trio-lighting.com

SAVE THE DATE



LICHTWOCHE
SAUERLAND

05. - 10.03.2023

lichtforumnrw

TRIO behält sich das Recht vor, zu jeder Zeit, notwendige Änderungen oder Aktualisierungen der in diesem Katalog enthaltenen Produkte vorzunehmen. · TRIO reserves the right to carry out any time, necessary changes or updates of the products in this catalogue. · TRIO se réserve le droit d'apporter à tout moment les modifications ou actualisations nécessaires aux produits dans ce catalogue. · TRIO behoudt zich het recht voor op ieder moment noodzakelijke wijzigingen of updates aan de producten in deze catalogus door te voeren. · TRIO se reserva , en todo momento, el derecho a realizar las modificaciones o actualizaciones que considere necesarias para cualquier producto de este catálogo. · TRIO si riserva il diritto di apportare, in qualunque momento, tutte le modifiche necessarie ai prodotti di questo catalogo. · TRIO-ul își rezervă dreptul de a face oricând orice modificări sau actualizări necesare pentru produsele din acest catalog. · TRIO pidättää oikeuden tehdä muutoksia tai päivittää tuotteita tässä luettelossa. · TRIO zastrzega sobie prawo do wprowadzania w dowolnym czasie zmian lub aktualizacji produktów zawartych w katalogu.

TRIO Leuchten GmbH

Gut Nierhof 17
D-59757 Arnsberg

T +49 (0) 2931 9666-0
F +49 (0) 2931 9666-28

info@trio-leuchten.de
www.trio-leuchten.de

TRIO International GmbH

Gut Nierhof 17
D-59757 Arnsberg

T +49 (0) 2931 9666-587
F +49 (0) 2931 9666-56

info@trio-lighting.com
www.trio-lighting.com

 @trioleuchten

 /trioleuchten

 @trio.lighting

LIGHTING FOR YOU