



KARMAN











Una luce per sempre... A light forever... Une lumière pour la vie... Una luz para siempre... 照明はいつもそこに

KARMAN

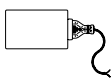
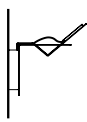





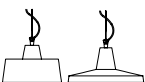





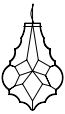
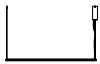

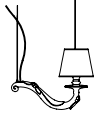

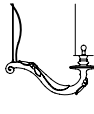





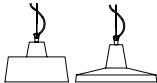

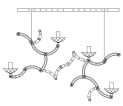



NOVITÀ

NEWS

	AMSTERDAM	pag.	20
	BIBENDUM		26
	CUPIDO		36
	GONZAGA		50
	NARCISO		60
	GIUSPINA		66
	LAMINA		72
	BINARELL		82
	UMARELL		90
	CLOUD OF LIGHT - CLUSTER		100
	ALÌ E BABÀ		108
	ALIBABABY		112
	GANGSTER		118







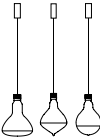
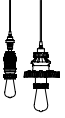
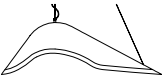

SOSPENSIONI

PENDANT

	24 KARATI	pag.	126		CUPIDO	pag.	36
	ALÌ E BABÀ		108		DÉJÀ-VU		154
	ALIBABABY		112		DÉJÀ-VU NU		156
	ALIBABIG		128		DIES NOX		158
	ATELIER		130		DOMENICA		160
	AU REVOIR		132		GANGSTER		118
	BACCO		134		GHEBO		162
	BAG		136		GINGER		166
	BIBENDUM		26		GONZAGA		50
	BLACK OUT		140		KIMONO		170
	BRAILLE		144		LE PUPETTE		172
	CAPODIMONTE		146		LE TRULLE		174
	CELL		148		LIFE		176
	CERAUNAVOLTA		150		LUCILLA		178

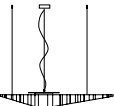
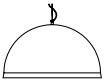
SOSPENSIONI

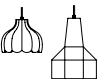
PENDANT

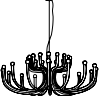
	MAKEUP	pag.	180
	MEK		184
	MOBY DICK		188
	MONO		190
	NANDO		194
	NORMA M		198
	NOTREDAME		200
	PLANCTON		202
	SAHARA		204
	SCRIVIMI		208
	SETTENANI COLLECTION		210
	SHERWOOD & ROBIN		214
	SISMA		218
	SNOOB		220

	T-BLACK	pag.	222
	TORCIA		224
	ULULÌ ULULÀ		226
	VIA RIZZO 7		228
	WORK IN PROGRESS		230
	WOW!		234











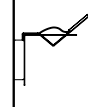

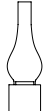





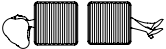

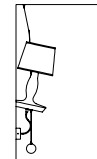

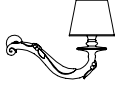

PLAFONIERE

CEILING LAMP

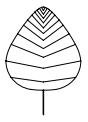
	BRILLE	pag.	240
	EDEN COLLECTION		242
	NOTREDAME		244



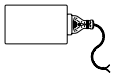

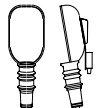





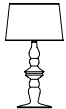





APPLIQUE

WALL LAMP

	ALÌ E BABÀ	pag.	114		LAMINA	pag.	72
	ALIBABIG		248		MAKEUP		272
	AMARCORD		250		MARNÌN		274
	AMSTERDAM		20		MOBY DICK		276
	APRILE		252		NANDO		278
	BINARELL		82		NARCISO		60
	BRAILLE		254		NORMA M		280
	CAPODIMONTE		256		NOTREDAME		282
	CUBANO		258		PORCAMISERIA		288
	DÉJÀ-VU		260		QUARANTASEI		290
	DOMENICA		262		TI VEDO		294
	EDEN COLLECTION		264		UGO RILLA		296
	GHEBO		266		UMARELL		90
	GIUSPINA		66		VA-LENTINA		300
	LIFE		270		WORK IN PROGRESS		302









TAVOLO

TABLE LAMP















	ALÌ E BABÀ	pag.	113		BAG	pag.	330
	ALIBABABY		113		BLACK OUT		332
	AMARCORD		306		CELL		334
	BACCO		310		CUPIDO		44
	BAG		314		DON'T TOUCH		338
	BRAILLE		316		LIFE		340
	NORMA M		318		LUCILLA		342
	TI VEDO		320		NORMA M		344





PIANTANE - TERRA

FLOOR LAMP

	ALFRED	pag.	324		SISMA		348
	ALÌ E BABÀ		116		TOBIA		350
	ALIBABIG		326		TORCIA		352
	ATELIER		328		ULULÌ ULULÀ		354
					VIA LATTEA		356

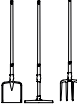
OUTDOOR

	ALIBABIG	pag.	360
	BLACK OUT		366
	CELL		368
	DIES NOX		374
	DON'T TOUCH		376
	GINGER		380
	GONZAGA		54
	KIMONO		382
	LAMINA		78
	MOBY DICK		386
	OTTAVO		388
	PLANCTON		390
	QUARANTASEI		392
	SETTENANI COLLECTION		394

	TOBIA	pag.	396
	TORCIA		400
	ULULÌ ULULÀ		404
	VIA LATTEA		406

DESIGNERS



MATTEO UGOLINI

Art director e creativo Karman, Matteo Ugolini, esce dagli schemi ordinari del design facendo entrare l'azienda in un percorso unico e caratteristico. Non ha muse ispiratrici tra i maestri del passato, lui crea semplicemente quello che gli piace. Il suo obiettivo è quello di emozionare, le sue radici sono ferme a quello che è il ricordo del passato e della natura alla quale è legato. Spesso la natura la troviamo presente nelle sue creazioni: essa entra a stretto contatto con l'uomo come avveniva un tempo, ricongiungendolo così all'elemento dal quale proviene e dal quale si sta allontanando sempre di più.

Art director and creative for Karman Matteo Ugolini slips away from ordinary design outlines entering along with the company in a unique and distinctive path. He has no muse among masters of the past: he just designs what he truly likes. His aim is to excite and create emotion, his roots are hold to the remembering of the past and nature that is deeply connected to. Very often we can find nature in his creations: it comes closer to human life just like it has always happened in the past. That process helps human race to come closer to that important element we are all gradually departing from: nature.

EDMONDO TESTAGUZZA

Edmondo Testaguzza nasce a Backnang (Repubblica Federale di Germania) nel 1964.

Dal 1997 è titolare dell'omonimo Studio di Design.

Prerogativa dell'attività progettuale svolta è la ricerca costante volta al raggiungimento di forme e contenuti dall'alto valore estetico/evocativo. Numerose le collaborazioni con aziende italiane ed estere. Storica la collaborazione con Karman assieme alla quale sviluppa nuovi linguaggi creativi in parallelo con la ricerca sui nuovi materiali.

Tutte le collezioni disegnate sono frutto di quest'attenzione alla materia ed alla sua valenza espressiva.

Edmondo Testaguzza was born in Backnang, Germany in 1964.

Since 1997 gives name to his design studio.

Premises to his attitude of projecting are made of regular researches aimed to achieve forms and shapes that should belong to a high aesthetic and suggestive value. He had many collaborations with Italian and international companies. Historic is the collaboration with Karman, together with who, he develops new creative languages in parallel with new materials.

All his designed collections are result of this attention to the research and to its expressive value



PAOLA NAVONE

Schietta, sognatrice, eclettica: nella sua anima convivono sapori e colori del sud del mondo, conosciuto, amato, frequentato, unite al gusto e alle forme dell'Occidente ricco di tradizioni, aperto, in movimento.

Da tutto ciò, la sua inesauribile curiosità alla ricerca di materie, forme e strutture, al presente, passato e futuro.

È architetto, designer, art director, interior designer.

Moltissime le mostre e gli allestimenti curati in tutto il mondo. Nell'83 vince l'International Design Award di Osaka, nel 2000 è Designer dell'anno per la rivista tedesca Architektur & Wohnen e nel 2011 vince con due progetti l'Elle Deco International Design Awards.

Nel 2014 riceve dalla rivista Interior Design Magazine la prestigiosa nomina a far parte della Hall of Fame del Design. Nel 2018 per la categoria arredi da esterno vince il terzo Elle Deco International Design Awards.

Collabora con le firme più importanti dello scenario internazionale ed italiano nel mondo del design.

Straightforward, a dreamer and eclectic: her mind and soul are a combination of flavours and colours of the South of the world - known, loved and lived - together with the taste and forms of the West, rich in traditions, open and continuously in movement. All of this produces her untiring curiosity in her research for matters and materials, forms and structures. In her research for the present, the past and the future.

Paola Navone is an architect. She is a product designer, an interior decorator and art director.

She is a creator of exhibitions and events all around the world. In 1983, she won the prestigious Osaka International Design Award. She is Designer of the Year in 2000 for the magazine Architektur&Wohnen. In 2011 won the Elle Deco International Design Awards for two project. On 2014 she has been inducted into Interior Design Magazine's prestigious Hall of Fame.

On 2018 she win the Elle Deco International Design Awards for the category outdoor furniture.

She has worked and still cooperates with most important companies of the international and Italian stage of the design world.



©Giovanni Gastel



BALDESSARI E BALDESSARI

Studio di architettura e design fondato da Giulio, Paolo e Michela Baldessari è un sodalizio professionale attivo nel campo dell'architettura, industrial e visual design, ed architettura d'interni.

Ha in corso progettazioni pubbliche e private nel settore residenziale, direzionale ed industriale, restauri di palazzi storici e d'epoca e progetti d'architettura d'interni oltre alla collaborazione con aziende nel settore del design come Riva 1920, Pallucco, Adele c, cc-tapis, De Castelli, Atipico, Twils, Starpool e Luce di Carrara.

Baldessari e Baldessari studio, founded by Giulio, Paolo and Michela Baldessari, is a professional association active in the fields of architecture, industrial, visual and interior design. It has public and private designs underway in the residential housing, office building and industrial facilities, it is working on the restauration of historic and antique palaces and on projects of interior design in addition to collaboration with design companies like Riva 1920, Pallucco, Adele c, cc-tapis, De Castelli, Atipico, Twils, Starpool e Luce di Carrara.

LUCA DE BONA & DARIO DE MEO

Luca e Dario, architetto e designer, si incontrano sul percorso tra Milano e il Veneto e iniziano una collaborazione che proprio dal viaggio attinge ispirazione per produrre segni e disegni di risposta alle esigenze dell'habitat contemporaneo. Collaborano con prestigiose aziende di arredo, illuminazione, decorazione occupandosi di direzione artistica, ideazione di concept e sviluppo di prodotti. Una ricerca in micro e macro scala che rilegge e fonde vari ambiti: architettura, design, grafica e arte per creare ambienti e oggetti innovativi, ma capaci di raccontare storie e indurre emozioni.

Luca and Dario, architect and designer, meet on the road between Milan and the Italian Veneto region and begin a collaboration that draws inspiration from the trip, to produce marks and drawings that respond to the needs of the contemporary home interiors. They collaborate with prestigious furnishing, lighting and decor companies, looking after art direction, concept and product development. A research in micro and macro scale that reviews and merges different spheres: architecture, design, graphics and art, to create innovative environments and objects, but able to tell stories and stir emotions.



STEFANO BIZZARRI & CLAUDIO CINTI

Obiettivo principale di Stefano Bizzarri e Claudio Cinti, i due designers che fanno capo dal 1995 allo studio pesarese "Bizzarri design", è stato sempre rivolto alla ricerca ed alla sperimentazione di nuovi materiali e/o di tecniche di lavorazione innovative nell'utilizzo di materiali tradizionali. Diverse le collaborazioni nel mondo del design. Oggi la progettazione nel campo del design e dell'architettura di interni è indirizzata all'esaltazione delle caratteristiche fisiche degli stessi elementi ed alle loro possibilità di aggregazione, per dar vita a soluzioni equilibrate (dal sicuro contenuto innovativo).

Main goal of the collaboration of Stefano Bizzarri and Claudio Cinti, two designers heading to 1995-established studio named Bizzarri Design, located in Pesaro is the continuous research of experimental fabrics and innovating working methods in using traditional workmanships for the interiors. Today main characteristics are basically the aggregation of different shapes and materials with result of an innovative thrilled balance (bearing an high innovating content).



GIORGIO BISCARO

Designer-non-designer all'incrocio tra studio, azienda, mercato, accademia, nuove tecnologie e relazioni sociali, da 20 anni è protagonista della progettazione della luce e vanta importanti collaborazioni e direzioni artistiche per i più celebri e riconosciuti brand di illuminazione e arredamento europei e mondiali, senza per questo tralasciare una libera sperimentazione a 360° attorno al progetto, alle tecnologie, ai materiali e al brand management. Elencato tra i più rappresentativi designer del nuovo millennio, nel 2012 co-fonda SomethingGood, un microbrand che commercializza prodotti decorativi d'alta qualità realizzati localmente in Italia con lo scopo di promuovere e valorizzare l'artigianato e il know-how italiano. Oltre a svolgere attività di consulenza in ambito internazionale, svolge attività di conferenziere sui temi del progetto e insegna in numerose università italiane.

A non-designer/designer dividing his work between study, business, market, academy, new technologies and social relations, he has been at the forefront of lighting design for 20 years and has some important collaborations to his credit, including roles as artistic director for the most famous and respected European and global lighting and furnishing brands – activities that have also included all-round, free experimentation in developing the project design, technologies, materials and the brand management. Numbered among the most representative designers of the new millennium, in 2012 he co-founded SomethingGood, a microbrand marketing high-quality decorative products created locally in Italy, with the aim of promoting and raising the profile of craftsmanship and Italian know-how. Apart from carrying out consultancy activities on an international scale, he lectures on design themes and teaches in many Italian universities.

LAURA ALESI & SILVIA BRACONI

Un'accurata analisi progettuale volta a combinare estetica e funzionalità; ricerca di soluzioni tecniche e materiali nella tradizione e nell'innovazione; perdersi nelle officine, nei laboratori e mescolare i saperi. Sono gli ingredienti che legano le due designer nei loro differenti ma complementari metodi di progettazione. Laura, giovane architetto, con un'ostinata cura per la ricerca e il dettaglio progettuali. Silvia, giovanissima industrial designer, capace di unire uno spiccato senso di pragmatismo all'incessante curiosità. L'incontro delle due professionalità ha tutte le caratteristiche necessarie per affermarsi nei vari settori del design.

A very careful project analysis aimed to combine form and function; an accurate research of technical solutions and materials within tradition and innovation; getting lost in workshops and laboratories to mix up different kinds of know how. Those are the main ingredients connecting the two designers in their different though complementary design attitudes. Laura: young architect with a tenacious care for research and design project's detail. Silvia: very young industrial designer able to match a marked sense of pragmatism to continual curiosity. That encounter of two valuable profiles bears all required features to enlighten interesting future design projects.



SOTIRIOS PAPADOPOULOS & GIOVANNA COLAPRISTI

Sotirios Papadopoulos si definisce architetto, artista, designer e production designer. Si laurea allo IUAV di Venezia in Architettura vincendo una borsa di studio a Los Angeles, all'Università USC, dove ottiene un Master in Architettura ed uno in Cinema dall'Accademia di George Lucas CNTV school. Dopo una lunga esperienza tra design, architettura e production design in USA, rientra in Europa cominciando a lavorare tra Milano, Parigi, Atene, nei settori architettura e design industriale. L'incontro con Karman nasce da una felice collaborazione con l'ABAVerona - Accademia di Belle Arti di Verona, dove Sotirios Papadopoulos è docente in design industriale in occasione di un approfondimento su alcune identità aziendali nel settore dell'illuminazione di design. Nasce da qui la selezione di un progetto ad opera della studentessa Giovanna Colapristi, progetto che il Prof. Sotirios Papadopolus ha supervisionato ed ottimizzato per essere inserito nella collezione ufficiale dell'azienda.



Sotirios Papadopoulos defines himself as Architect, Artist, Designer and Production Designer. He obtained his degree in Architecture at IUAV winning a scholarship in Los Angeles, to University USC, where she attended a Master in Architecture and one in Cinema from Academy of George Lucas CNTV school. After a long experience in Design, Architecture and Production Design in USA, returns to Europe starting to work in Milan, Paris, Athens, in the fields of Architecture and Industrial Design. The meeting with Karman was born from a successful collaboration with the ABAVerona - Academy of Fine Arts in Verona, where Sotirios Papadopoulos is Lecturer in industrial design, on the occasion of the in-depth study of some corporate identities in lighting design. This gives rise to the selection of a project by the student Giovanna Colapristi, project that the Prof. Sotirios Papadopolus oversaw and suggested to be included in the official collection of the company.

A LIGHT FOREVER

Oltre a tutto ciò che ci accomuna
liberi di essere.

Itinerario fotografico nelle vite di chi ha deciso di fare della
propria esistenza un percorso di coerenza e passione.

*As well as all that binds us together
free to exist.*

*Photographic itinerary through the lives of those who have decided to turn
their own existence into a journey of cohesion and passion.*







Davide Diamantini

age 48

CEO Karman

Matteo Ugolini

age 45

Designer / Art Director Karman

Edmondo Testaguzza

age 54

Designer / Research & Development Karman

Spogliàti dei pregiudizi della gente.
La voglia di divertirsi che non passa mai.
Tra momenti di gioia e difficoltà
ci siamo concessi la libertà di offrire libera espressione.
Ammantati di lucida follia
sempre fedeli ai nostri valori e principi
noi
andiamo avanti.

*When we shake off other people's prejudices.
The desire to have fun never goes away.
Between moments of joy and difficulty
we have allowed ourselves the liberty of offering free expression.
Clothed in clear-headed madness
ever faithful to our values and principles
we
go on.*



AMSTERDAM

design matteo ugolini

La lampada Amsterdam entra di diritto nel fantastico e luminoso "zoo di Karman": ispirata a un bulldog di casa nella capitale olandese ma famoso in tutto il mondo...

The Amsterdam lamp takes its rightful place in the fantastic and bright "Karman zoo": it's inspired by a bulldog that has found its home in the Dutch capital city and become famous throughout the world...





AMSTERDAM

design
matteo ugolini



Struttura in ceramica opaca.
Structure in matt ceramic.



AP191 BB INT (grigio/grey)
AP191 BA INT (bianco/white)

applique / wall lamp
cm 41 x 25

3 x max 10W LED E27



Lauretta Tallarini

age 70

Free Spirit

Il mio tempo non ha età:
è questo presente che non ha passato né domani.
l'istante, sospeso
sull'esistenza sconfinata che divengo.

*My time is ageless:
it is this present that has no past or tomorrow.
it is the instant, suspended
from the limitless existence I am becoming.*



BIBENDUM

design paola navone

Bibendum è una piccola magia luminosa. La magia che accade quando da una tradizione artigianale prende vita un oggetto inaspettato e divertente, capace di rendere un po' speciale la vita di ogni giorno.

Bibendum is a trick of lighting magic – the magic that happens when a handcrafted tradition gives rise to an unexpected, fun object, capable of making everyday life a little bit special.





BIBENDUM

design
paola navone



Diffusore in vetro.
Shade in glass.



SE198 AV INT (trasparente/clear) 2700K
SE198 AE INT (bianco/white) 2700K
SE198 AT INT (trasparente/clear) 3000K
SE198 AD INT (bianco/white) 3000K
sospensione / pendant
cm Ø15 h 18
LED 1x5W 500 lumen, CRI ≥ 80



SE198 CV INT (trasparente/clear) 2700K
SE198 CE INT (bianco/white) 2700K
SE198 CT INT (trasparente/clear) 3000K
SE198 CD INT (bianco/white) 3000K
sospensione / pendant
cm Ø30 h 35
LED 1x17W 1700 lumen, CRI ≥ 80



SE198 BV INT (trasparente/clear) 2700K
SE 198 BE INT (bianco/white) 2700K
SE198 BT INT (trasparente/clear) 3000K
SE198 BD INT (bianco/white) 3000K
sospensione / pendant
cm Ø35 h 25
LED 1x17W 1700 lumen, CRI ≥ 80





BIBENDUM

design
paola navone





BIBENDUM

design
paola navone

Diffusore in vetro.
Shade in glass.



SE198 DT INT

(trasparente/clear)

SE198 DD INT

(bianco/white)

sospensione / pendant

cm Ø15 h 18

1 x max 42W E14



SE198 ET INT

(trasparente/clear)

SE198 ED INT

(bianco/white)

sospensione / pendant

cm Ø35 h 25

1 x max 105W E27



SE198 FT INT

(trasparente/clear)

SE198 FD INT

(bianco/white)

sospensione / pendant

cm Ø30 h 35

1 x max 105W E27



Riccardo Tondi

age 40

Player of the Italian Amputee football team

Le mie mani sono forti
i miei passi leggeri
l'occhio veloce.
Corro libero su prati verdi senza fine
sotto cieli azzurri travolgenti.
Non tentate di raggiungermi.
Io sono oltre.

My hands are strong

my steps light

my eye quick.

I run freely over endless green meadows

under overwhelming blue skies

do not try to catch up with me.

I am elsewhere.



CUPIDO

design **matteo ugolini**

Un progetto che nasce con l'intento di far "innamorare", convivere in perfetta armonia due mondi diversi, quello dell'illuminazione tecnica e quella decorativa. Prende forma così Cupido, una lunga e minimale barra di luce a led che trafigge un paralume in tessuto.

A project originating with the intention of making two different worlds - of technical lighting and decorative lighting - "fall in love", and live in perfect harmony. This has given rise to Cupido, a long, minimal bar of led light piercing a fabric lampshade.







CUPIDO
design
matteo ugolini



Struttura in alluminio nero opaco.
Structure in matt black aluminium.



SE194 A1 INT

sospensione / *pendant*
cm Ø2.5 l. 99
strip LED 2x18W 3920 lumen
bianco dinamico con app / *tunable white by app*
2700-5000K CRI ≥ 90



SE194 B1 INT

sospensione / *pendant*
cm Ø2.5 l. 149
strip LED 2x26W 5880 lumen
bianco dinamico con app / *tunable white by app*
2700-5000K CRI ≥ 90

Accessorio sospensione in cotone antracite.
Optional for pendant in charcoal cotton.



AC184 AB INT

(stampato / *printed*)
cm Ø23 h. 24



AC184 AC INT

(non stampato / *not printed*)
cm Ø23 h. 24



CUPIDO
design
matteo ugolini

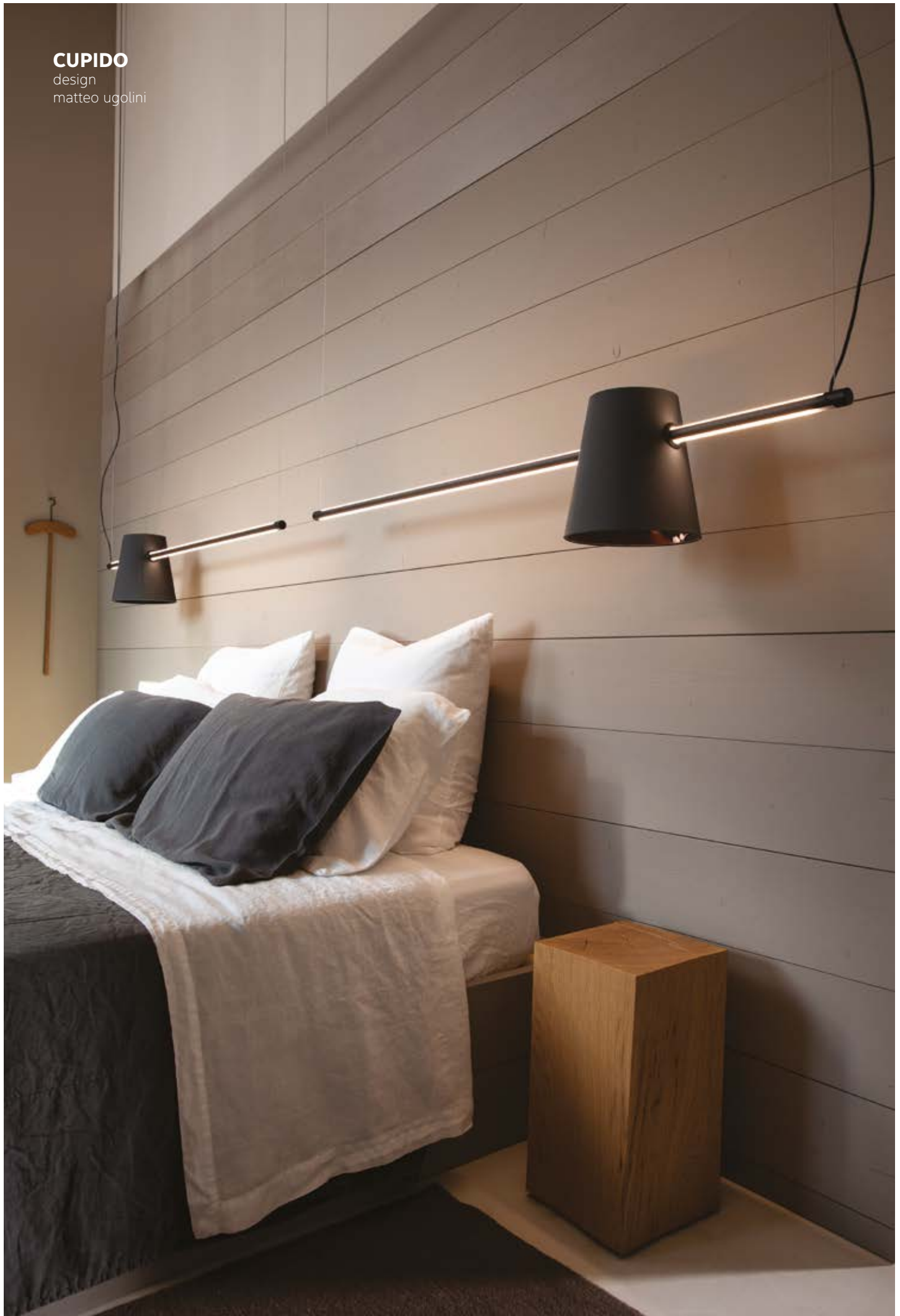

CUPIDO
design
matteo ugolini





Diffusore in cotone antracite con stampa interna.
Shade in charcoal cotton with inner print.



SE194 DD INT
 sospensione
pendant
 cm Ø40 h 42
 1 x max 105W E27



SE194 CD INT
 sospensione
pendant
 cm Ø26 h 24
 1 x max 50W E27



CUPIDO

design matteo ugolini

Struttura in alluminio nero opaco.
Structure in matt black aluminium.

HP194 B3 INT

lampada cielo terra
hanging-floor lamp

cm Ø8

strip LED 28W

3100 lumen

bianco dinamico con app

tunable white by app

2700-5000K CRI ≥ 90





CUPIDO
design
matteo ugolini

Struttura in alluminio nero opaco
e cemento grigio tortora.
*Structure in matt black
aluminium and dove grey
concrete.*

 **HP194 A2 INT**
piantana / floor lamp
cm Ø25 h 220
strip LED 36W
3920 lumen
bianco dinamico con app
tunable white by app
2700-5000K CRI ≥ 90

Accessorio per piantana in
cotone antracite.
*Optional for floor lamp in
charcoal cotton.*

 **AC184 BB INT**
(stampato / printed)
cm Ø23 h. 24

 **AC184 BC INT**
(non stampato
not printed)
cm Ø23 h. 24



Amedeo Sartori
alias *Nando*
age 57

Dancer for passion

Amo danzare, è una febbre
qualcosa che non si può spiegare.
Nella mia mente c'è un posto nel quale io non sono più io:
come la crisalide muta in farfalla
nel silenzio del mio universo io divengo aria.

*I love dancing, it's an obsession
something that cannot be explained.
In my mind there's a place where I'm not myself any more:
like a chrysalis changing into a butterfly
in the silence of my universe I become air.*



GONZAGA

design

luca de bona, dario de meo
& matteo ugolini

Gonzaga, una lampada che sembra danzare nello spazio con le sue geometrie minimali sulle quali luci e ombre si rincorrono all'infinito generando un silente dinamismo scenografico.

Gonzaga: a light that seems to dance in space with its minimal geometric shapes on which lights and shadows chase each other to infinity, generating a silent cinematic dynamism.



GONZAGA

design
luca de bona
dario de meo
matteo ugolini

Struttura in alluminio.
Structure in aluminium.



SE185 GD EXT (bianco/white)
SE185 GC EXT (nero/black)
SE185 DD EXT (ottone/brass)
sospensione / pendant
cm Ø42 h 8
LED 13W 1200 lumen
2700K CRI ≥ 80



SE185 FD EXT (bianco/white)
SE185 FC EXT (nero/black)
SE185 DC EXT (ottone/brass)
sospensione / pendant
cm Ø42 h 8
LED 13W 1200 lumen
3000K CRI ≥ 80

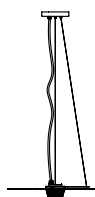

SE185 ED EXT (bianco/white)
SE 185 EC EXT (nero/black)
SE 185 CD EXT (ottone/brass)
sospensione / pendant
cm Ø59 h 8
LED 13W 1200 lumen
2700K CRI ≥ 80

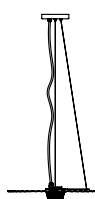

SE185 BD EXT (bianco/white)
SE185 BC EXT (nero/black)
SE185 CC EXT (ottone/brass)
sospensione / pendant
cm Ø59 h 8
LED 13W 1200 lumen
3000K CRI ≥ 80





GONZAGA

design
luca de bona
dario de meo
matteo ugolini





GONZAGA

design
luca de bona
dario de meo
matteo ugolini





Massimo Pianosi
alias *Il Pianoso*
age 71

Front man Karman

Ho combattuto infinite battaglie.
Nessun'avversità può più nuocermi,
Sono già morto e risorto mille volte.

*I have fought infinite Battles.
No adversity can harm me any more,
I have already died and risen again thousands of times.*



NARCISO

design matteo ugolini



In un gioco di rimandi mitologici e luminosi, questa fonte riflette la sua stessa luce come l'immagine di Narciso nello specchio.

In a medley of references to mythology and light, this source reflects its own light like the image of Narcissus in the mirror.





NARCISO

design
matteo
ugolini

Struttura in alluminio bianco opaco
e vetro satinato.

*Structure in matt white aluminium
and frosted glass.*



AP202 AT INT (2700K)
AP202 AD INT (3000K)

applique / wall lamp
cm l. 18 h. 18 p. 10

LED sopra/up

9,2W 1162 lumen

LED sotto/down

6,4W 610 lumen

CRI ≥ 80

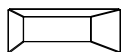

AP 202 BT INT (2700K)
AP202 BD INT (3000K)

applique / wall lamp
cm l. 28 h. 12 p. 10

LED sopra/up

9,2W 1162 lumen

LED sotto/down

6,4W 610 lumen

CRI ≥ 80



Enrico Perugini

age 73

Retired

Riccardo Pazzaglia

age 2

Child

Ho percorso la via
fino a sera.
Ora trovo te che inizi il tuo cammino.
Non ricordo i miei primi passi
le mani che mi presero e fecero di me un uomo.
Però vedo i tuoi occhi
lo stesso sguardo di un tempo lontano.

*I have travelled the way
until the evening.
Now I find you starting your journey.
I do not remember my first steps
the hands that picked me up and made a man of me.
But I see your eyes
the same gaze as in a far-off time.*



GIUSPINA

design matteo ugolini

Evocare un ricordo dal passato. Giuspina torna a rivivere con semplicità e carattere, trasformando il suo difetto in un valore aggiunto.

Evoking a memory from the past, Giuspina returns to live again with simplicity and character, transforming its defect into an added value.





GIUSPINA

design matteo ugolini

Struttura in ceramica bianca opaca e bronzo lucido.
Structure in matt white ceramic and glossy bronze.

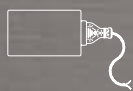

AP 187 AB INT (2700K)

AP 187 AA INT (3000K)

applique / wall lamp

cm l. 23 p. 9 h. 10

2x5,2 W 684 lumen

tot. 1368 lumen CRI \geq 80





Marina Leonardi

age 43

Tattoo Artist

Io sono un fiore.
Protesa verso l'alto respiro la luce.
Sul mio corpo il racconto indelebile si schiude e svela.
Perché essere normali quando si può essere straordinari...!?

I am a flower.

Reaching upwards I breathe the light.

On my body the indelible story opens up and reveals itself.

Why be normal when one can be extraordinary...!?



LAMINA

design edmondo testaguzza

Due sottili lamine metalliche s'incontrano e intersecano. Attraversate da un cavetto elettrico (rosso nella versione indoor), esprimono attraverso una geometria rigorosa un delicato legame armonico. Una lampada minimale pensata per generare luce raffinata.

Two slender metal plates meet and intersect. Crossed by a thin electric cable (red in the indoor version), they express a delicate harmonic link by means of a strict geometrical pattern. A minimal lamp, designed to generate refined light.





LAMINA

design
edmondo testaguzza



Struttura in alluminio bianco opaco.
Structure in matt white aluminium.



AP192 AB INT

applique
wall lamp
cm l. 13 h. 18 p. 19,5
LED 12,4W
1300 lumen
3000K CRI \geq 80





LAMINA
design
edmondo
testaguzza

NEWS



LAMINA

design
edmondo
testaguzza

Struttura in alluminio bianco opaco.
Structure in matt white aluminium.



AP192 AB EXT

applique
wall lamp
cm l. 13 h. 18 p. 19,5
LED 12,4W
1300 lumen
3000K CRI \geq 80
IP55



Francesco Palmisano

age 50

Interior Designer & CrossFitter for passion

La bellezza annulla l'istante della perdizione
che ci ha travolti
dissolve il furore dei nostri gesti
il clamore suscitato.

"Magnificat anima mea Dominum"

*Beauty cancels out the instant of perdition
that has overwhelmed us
it dissolves the frenzy of our gestures
the turmoil it has aroused.*

"Magnificat anima mea Dominum"



BINARELL

design giorgio biscaro

Un doppio blocco luminoso che, dividendosi, mantiene la relazione tra le parti che lo compongono, in un costante dialogo funzionale degno dei migliori illusionisti.

A double light-fitting that splits up but maintains the relationship between its component parts, in a constant functional dialogue worthy of the best illusionists.







BINARELL

design
giorgio biscaro

Struttura in ceramica bianca opaca e
vetro satinato
*Structure in matt white ceramic and
frosted glass.*

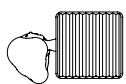

AP200 AT INT (2700K)
AP200 AD INT (3000K)
applique / wall lamp
cm l. 23 h. 13 p. 10
LED sopra/up
7,35W 958 lumen
LED sotto/down
2,4W 324 lumen
CRI ≥ 80

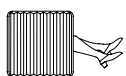

AP200 BT INT (2700K)
AP200 BD INT (3000K)
applique / wall lamp
cm l. 23 h. 13 p. 10
LED sopra/up
7,35W 958 lumen
LED sotto/down
2,4W 324 lumen
CRI ≥ 80



BINARELL

design
giorgio biscaro





Davide Diamantini

age 48

CEO Karman

C'è un giorno che cambia la nostra vita.
Il giorno che sovverte il destino.
Per non essere mai più uguali a tutto ciò che siamo stati.
A tutto ciò che è stato.
È una rivoluzione che spariglia.
L'energia che come una folgore illumina l'orizzonte.
L'istante che segna il tempo.
L'era di una nuova luce.

There is one day that changes our life.

The day that overturns fate.

So that we are no longer the same as anything we have been.

As anything that has been.

It is a revolution that throws things into disorder.

The energy that lights up the horizon like a bolt of lightning.

The instant that marks the time.

The era of a new light.



UMARELL

design giorgio biscaro

Come il tesoro archeologico che ogni vecchietto sogna venga rinvenuto in cantiere sotto la sua attenta supervisione, la luce emerge dal blocco sospeso inondando il fidato Umarell di luce.

Like an archaeological treasure that any elderly person dreams might be discovered in their cellar under their careful supervision, the light emerges from the suspended lighting unit, flooding the trusty Umarell with light.





UMARELL

design
giorgio biscaro



Struttura in ceramica bianca opaca
e vetro satinato.
*Structure in matt white ceramic
and frosted glass.*



AP199 HD INT (2700K)
AP199 HT INT (3000K)
applique / wall lamp
cm l. 18 p. 10 h. 13
LED sopra/up
7,35W 958 lumen
LED sotto/down
2,4W 324 lumen
CRI \geq 80

Accessorio in ceramica bianca opaca.
Optional in matt white ceramic.



AC199 AC INT
cm h. 13
AC199 BC INT
cm h. 16
AC199 CC INT
cm h. 15



UMARELL
design
giorgio biscaro







UMARELL

design
giorgio biscaro



CLOUD OF LIGHT

design edmondo testaguzza & matteo ugolini

Coniugano funzionalità e grande pulizia formale.
Una semplice soluzione tecnica che permette di realizzare
composizioni nel segno della libertà creativa.
Declinati nelle forme circolari e lineare, Karman propone
per ciascuna tipologia e dimensione di rosone *Cloud of Light*,
una soluzione di lampade di grande suggestione.

*They combine functionality and formal elegance.
A simple technical solution that allows to realize
compositions as a sign of a creative freedom.
In circular and linear shapes, Karman offers,
for each type and dimension of the Light Cloud ceiling cup,
a selection of lamps of a great awesomeness.*





COMPOSIZIONE Ø70

design
edmondo testaguzza
matteo ugolini

SEO70BB INT





COMPOSIZIONE Ø50

design
edmondo testaguzza
matteo ugolini

SE050 NT INT



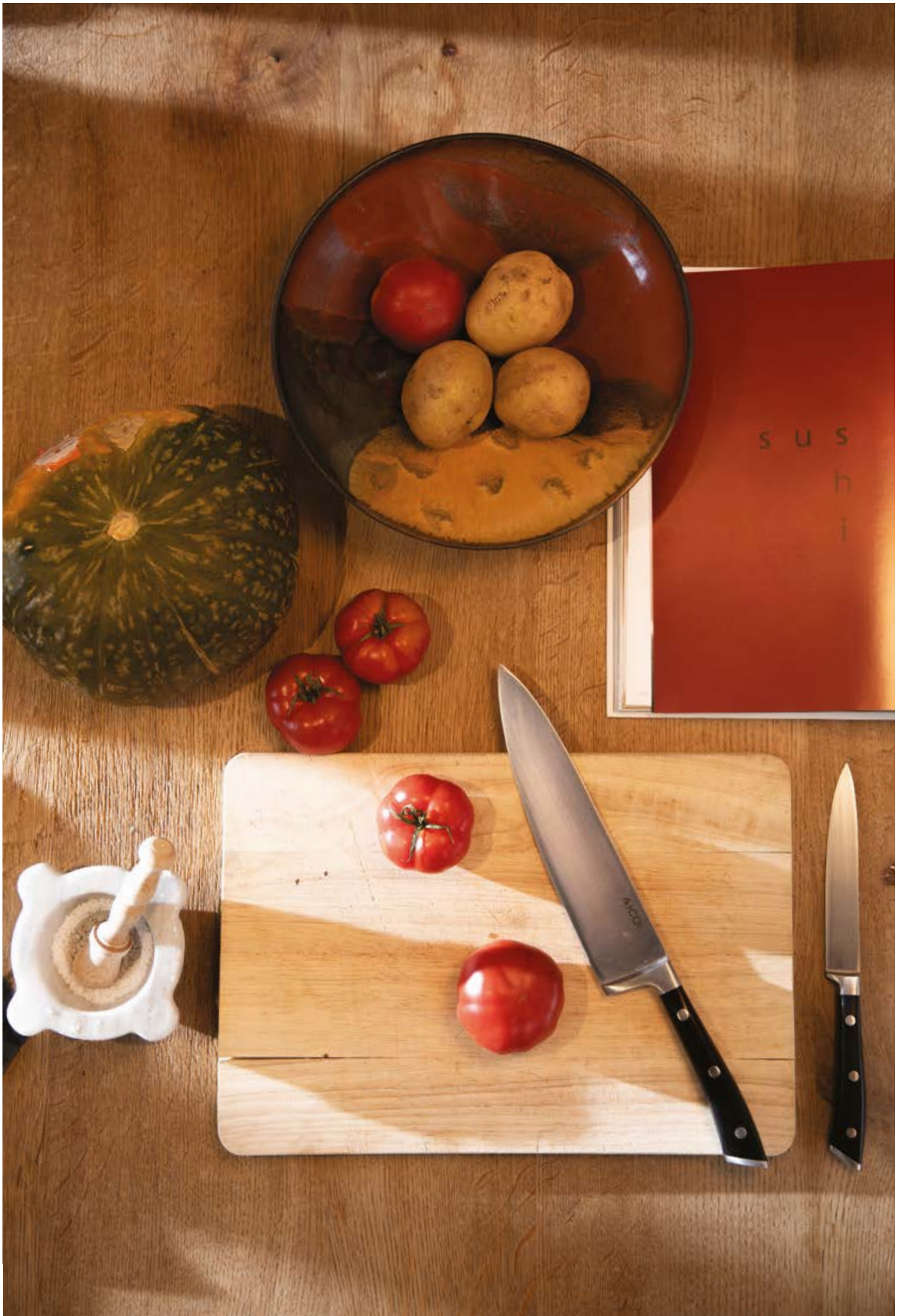

COMPOSIZIONE 90

design
edmondo testaguzza
matteo ugolini

SE090DB INT

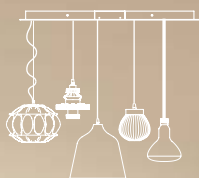

REWIND

In questa sezione vogliamo riproporre collezioni storiche Karman fotografate ex novo in contesti aggiornati.

Il divenire del tempo muta gusto, usi e costumi rendendo obsoleto tutto ciò che non rientra nei canoni dell'attualità più stringente.

Riproporre in ambiti attuali lampade Karman pensate in anni addietro tende a metterne in rilievo la longevità e ne perpetua la freschezza senza tempo.

In this section we would like to propose some historic collections of Karman again, newly photographed in revised contexts.

The passage of time changes taste, customs and practices, making obsolete anything that is not within the persuasive current rules.

Relaunch in present contexts Karman lightings, that have been designed some years ago, highlights their longevity and perpetuate their timeless freshness.



ALÌ E BABÀ

design matteo ugolini

Ispirata per nome e profilo alle favole orientali de "Le mille e una notte", Alì & Babà è la collezione Karman più ricca per dimensioni e declinazioni, tutte di eguale temperamento.

Come se "Accenditi Sesamo" divenisse un auspicio, oltre che una suggestione.

Inspired for name and profile to oriental fairy tales of "One thousand and One nights", Ali & Babà is the richest in Karman's collection for dimensions and both declination, all of them having though the same temper. As if the speech "Light Up, Sesame" could become a wish, besides illusion.

Struttura in ceramica bianca lucida e paralume in lino bianco.
Structure in glossy white ceramic and shade in white linen.



SE623BS

sospensione / pendant
cm Ø 25 h 65
1 x max 52W E27



SE619BS

sospensione / pendant
cm Ø 35 h 95
1 x max 70W E27



SE622BS

sospensione / pendant
cm Ø 30 h 65
1 x max 52W E27



SE618BS

sospensione / pendant
cm Ø 50 h 78
1 x max 70W E27





ALÌ E BABÀ

design matteo ugolini

Struttura e paralume in ceramica bianca lucida.
Structure and shade in glossy white ceramic.



SE625BC
sospensione / *pendant*
cm Ø 25 h 65
1 x max 52W E27



SE617BC
sospensione / *pendant*
cm Ø 35 h 95
1 x max 70W E27



SE624BC
sospensione / *pendant*
cm Ø 30 h 65
1 x max 52W E27



SE616BC
sospensione / *pendant*
cm Ø 50 h 78
1 x max 70W E27





ALIBABABY
design matteo ugolini

Struttura e paralume in ceramica bianca lucida.
Structure and shade in glossy white ceramic.



SE1017BC
sospensione / pendant
cm Ø 16 h 44
1 x max 52W E27

ALÌ E BABÀ

design matteo ugolini

Struttura in ceramica bianca lucida
e paralume in lino bianco.
*Structure in glossy white ceramic
and shade in white linen.*

**C1016BS**

lampada da tavolo
table lamp
Ø 35 h 68 cm
1 x max 70W E27

ALIBABABY

design matteo ugolini

Struttura in ceramica bianca lucida
e paralume in lino bianco.
*Structure in glossy white ceramic
and shade in white linen.*

**C1017BS**

lampada da tavolo
table lamp
Ø 20 h 40 cm
1 x max 42W E14





ALÌ E BABÀ

design
matteo ugolini

Struttura e paralume in ceramica naturale predisposta per la tinteggiatura.

Structure and shade in white rough ceramic, can be painted or decorated at user description.



AP625

applique / wall lamp
cm l. 30,5 h. 60 p. 18,5
1 x max 52W E27

Struttura in ceramica naturale predisposta per la tinteggiatura e paralume in lino bianco.

Structure in white rough ceramic, can be painted or decorated at user description and shade in white linen.

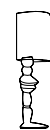

AP625LS

applique / wall lamp
cm l. 29 h. 60 p. 20
1 x max 52W E27

Struttura in ceramica bianca lucida e paralume in lino bianco.

Structure in glossy white ceramic, and shade in white linen.



AP625CBS

applique / wall lamp
cm l. 29 h. 60 p. 20
1 x max 52W E27

Struttura e paralume in ceramica bianca lucida.

Structure and shade in glossy white ceramic.



AP625B

applique / wall lamp
cm l. 30,5 h. 60 p. 18,5
1 x max 52W E27



ALÌ E BABÀ

design matteo ugolini

Struttura in ceramica bianca lucida e paralume in lino bianco.
Structure in glossy white ceramic and shade in white linen.



H6025CBS

piantana con fissaggio a parete
wall fixed floor lamp
cm l. 39 p. 23 h. 150
1 x max 70W E27





GANGSTER

design matteo ugolini

Una gang di forme pure e semplici si aggira vestita completamente di bianco, tranne il suo leader che è anche foderato di bronzo; essa mira a portare luce morbida nei tuoi spazi...

A gang of pure and simple shapes roams completely dressed in white, but his leader who's also covered in gunmetal; their aim is to bring slick lighting to your surroundings...





GANGSTER

design matteo ugolini

Diffusore in ceramica bianca lucida,
interno color bronzo o bianco.
*Shade glossy white ceramic, inner
part bronze or white colour.*



SE644 BB (bianco/white)
SE644 BR (bronzo/bronze)
sospensione / pendant
cm Ø 28 h 20
1 x max 70W E27



SE643BB (bianco/white)
SE643BR (bronzo/bronze)
sospensione / pendant
cm Ø 35 h 15
1 x max 70W E27



SE642BB (bianco/white)
SE642BR (bronzo/bronze)
sospensione / pendant
cm Ø 48 h 35
1 x max 105W E27



SE641BB (bianco/white)
SE641BR (bronzo/bronze)
sospensione / pendant
cm Ø 50 h 22
1 x max 105W E27





GANGSTER

design
matteo ugolini







**SO
SPEN
SIONI**

pendant

24 KARATI

design matteo ugolini



*Unit of measure
estimating the
utmost pureness of
a noble element.*

Struttura in vetro trasparente.
Structure in clear glass.

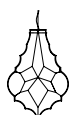

SE104 1G INT

(paglierino/pale yellow)

SE104 1F INT (fumé/smoked)

sospensione / pendant

cm 38x24 h. 54

1 x max 70W E27



SE113 1G INT

(paglierino/pale yellow)

SE113 1F INT (fumé/smoked)

sospensione / pendant

cm ø 28 p. 16

1 x max 70W E27



ALIBABIG

design matteo ugolini





Struttura in vetroresina.
Structure in fiberglass.



SE617V-INT

sospensione / pendant
cm ø 40 h. 110

1 x max 105W (sotto/down) + 1 x 42W (sopra/up) E27



SE616V-INT

sospensione / pendant
cm ø 50 h. 110

1 x max 105W (sotto/down) + 1 x 42W (sopra/up) E27

Versioni disponibili: APPLIQUE / SOSPENSIONE / PIANTANA TERRA / OUTDOOR
Available versions: WALL LAMP / PENDANT / FLOOR LAMP / OUTDOOR

ATELIER

design matteo ugolini



Paralume in poliestere pennellato.
Shade in polyester white painted.



SE689S
sospensione / *pendant*
cm ø 43 h. 57
1 x max 105W E27

Versioni disponibili: SOSPENSIONE / PIANTANA TERRA
Available versions: PENDANT / FLOOR LAMP



AU REVOIR

design matteo ugolini

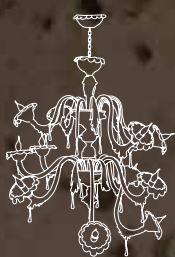

Struttura in vetro bianco opalino
incamiciato, componibile.
*Structure in white opal glass
in triple layer modular.*

SE110 AB INT

sospensione / pendant
cm 122 h. 190
11 x max 42W E14



Struttura in vetro bianco opalino
incamiciato, componibile.
*Structure in white opal glass
in triple layer modular.*

SE110 BB INT

sospensione / pendant
cm 122 h. 190
5 x max 42W E14

BACCO

design matteo ugolini



Struttura in vetro bianco satinato.
Structure in white frosted glass.



SE143 1B INT
sospensione singola
single pendant
cm Ø9 x h.34
1 x max 33W, G9



SE 143 1B 00A
sospensione multipla
multiple configuration
cm Ø30 circa
6 x max 33W, G9



SE143 2B INT
sospensione per
composizione multipla
pendant for multiple
configuration
cm Ø9 x h.34
1 x max 33W, G9

SR005 2B INT (max 4)
SR064 2B INT (max 15)
rosone in metallo per
composizione multipla
ceiling cup for multiple
configuration

Versioni disponibili: SOSPENSIONE / TAVOLO
Available versions: PENDANT / TABLE LAMP



BAG

design baldessari e baldessari



Struttura in ceramica liscia e
manico in metallo verniciato grigio.
*Structure in smooth ceramic
and handle in grey metal*

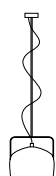

SE154 CB INT (bianca/white)
SE154 CR INT (bronzo/bronze)
sospensione
pendant
cm Ø21 x h 20
1 x max 53W E27

Struttura in ceramica lucida con texture
e manico in metallo verniciato grigio.
*Structure in glossy ceramic with texture
and handle in grey metal.*

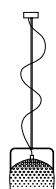

SE154 DB INT (bianca/white)
SE154 DR INT (bronzo/bronze)
sospensione
pendant
cm Ø21 x h 20
1 x max 53W E27

Versioni disponibili:
SOSPENSIONE / TAVOLO / PIANTANA TERRA
*Available versions:
PENDANT / TABLE LAMP / FLOOR LAMP*





BAG

design
baldessari e baldessari

Struttura in ceramica liscia lucida e manico in metallo verniciato grigio.
Structure in smooth glossy ceramic and handle in grey metal.

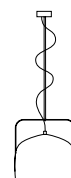

SE154 AB INT (bianca/white)
SE154 AR INT (bronzo/bronze)
sospensione
pendant
cm Ø32 x h 32
1 x max 77W E27

Struttura in ceramica lucida con texture e manico in metallo verniciato grigio.
Structure in glossy ceramic with texture and handle in grey metal.

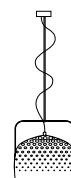

SE154 BB INT (bianca/white)
SE154 BR INT (bronzo/bronze)
sospensione
pendant
cm Ø32 x h 32
1 x max 77W E27

Versioni disponibili:
SOSPENSIONE / TAVOLO / PIANTANA TERRA
Available versions:
PENDANT / TABLE LAMP / FLOOR LAMP



BLACK OUT

design matteo ugolini







BLACK OUT

design matteo ugolini

Struttura in filamento di vetroresina.
Structure in painted fiberglass.



SE101 1B INT (bianco/white)
SE101 1T INT (trasparente/clear)
sospensione / pendant
cm ø 35 h. 40
1 x max 53W E27



SE101 2B INT (bianco/white)
SE101 2T INT (trasparente/clear)
sospensione / pendant
cm ø 50 h. 60
3 x max 53W E27



AC101 1B INT
portacandele in ceramica bianca
candle-holder in white ceramic

Versioni disponibili: SOSPENSIONE / PIANTANA TERRA / OUTDOOR
Available versions: PENDANT / FLOOR LAMP / OUTDOOR





BRAILLE

design matteo ugolini



Struttura in vetro bianco satinato.
Structure in white frosted glass.



SE144 1B INT
sospensione / pendant
cm Ø25 x h.25
1 x max 46W, E14



SE144 2B INT
sospensione / pendant
cm Ø40 x h.38
1 x max 105W, E27

Versioni disponibili: TAVOLO / SOSPENSIONE / PLAFONIERA
Available versions: TABLE LAMP / PENDANT / CEILING LAMP

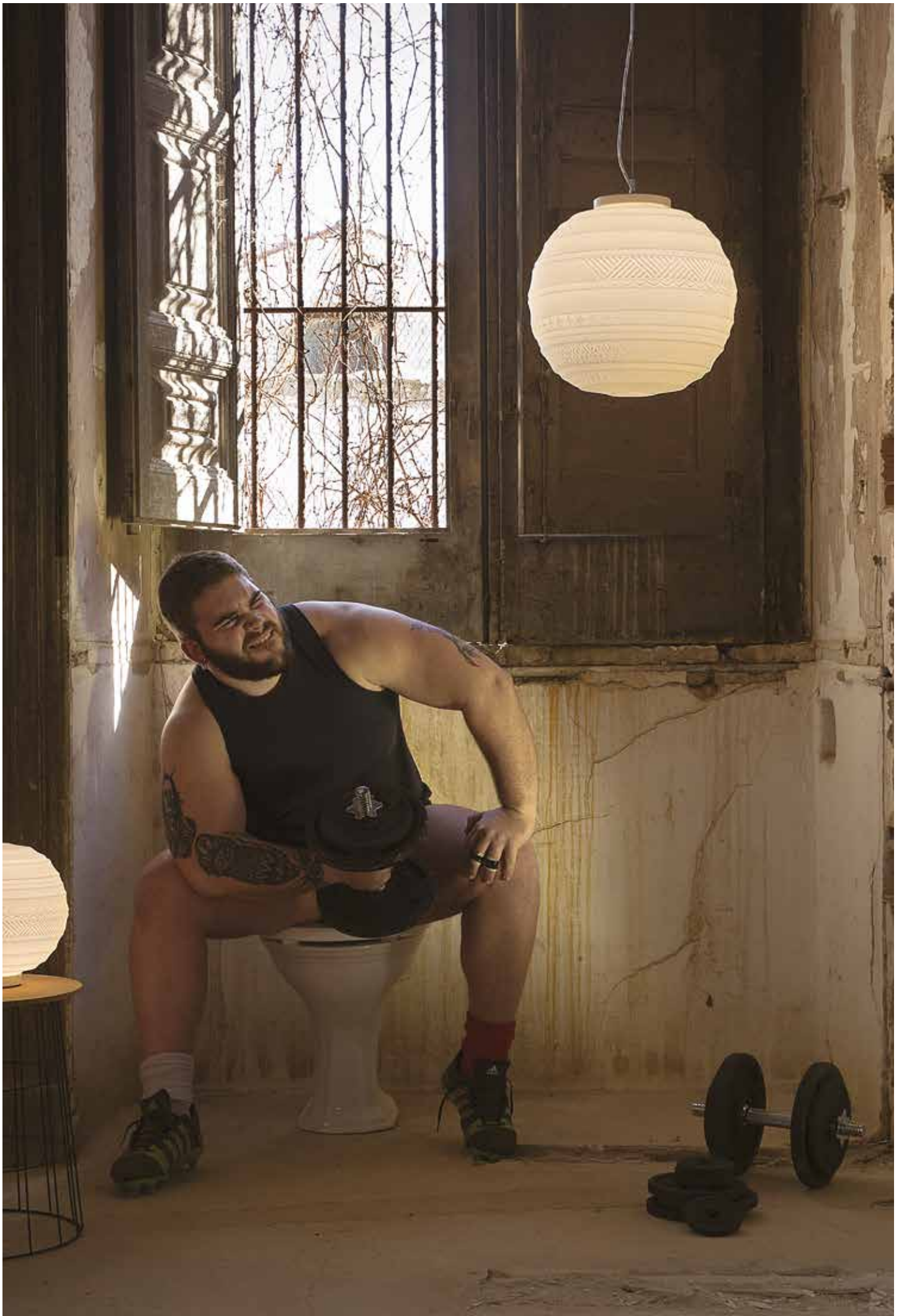

CAPODIMONTE

design matteo ugolini





Struttura in ceramica bianca.
Structure in white ceramic.



SE129 1B INT
sospensione
pendant
cm h. 26 ø 6
1 x max 20W GU10

Versioni disponibili: APPLIQUE / SOSPENSIONE
Available versions: WALL LAMP / PENDANT

CELL

design matteo ugolini



Struttura in filo metallico, paralume in lino bianco.
Structure in metallic thread, shade in white linen.

SE614B (bianco/white)

SE614 CM INT (bronzo/bronze)

sospensione / pendant

cm ø 36 h. 58 + h. 29

1 x max 42W E27



SE615B (bianco/white)

SE615 DM INT (bronzo/bronze)

sospensione / pendant

cm ø 55 h. 88 + h. 41

1 x max 52W E27



SE612B (bianco/white)

SE612 AM INT (bronzo/bronze)

sospensione / pendant

cm ø 57 h. 59 + h. 29

1 x max 52W E27



SE613B (bianco/white)

SE613 BM INT (bronzo/bronze)

sospensione / pendant

cm ø 84 h. 89 + h. 41

1 x max 52W E27



Versioni disponibili: SOSPENSIONE / PIANTANA TERRA / OUTDOOR
Available versions: PENDANT / FLOOR LAMP / OUTDOOR



CERAUNAVOLTA

design matteo ugolini & edmondo testaguzza



Struttura in vetro soffiato.
Structure in blown glass.



SE134 2T 00A (tiffany)
SE134 2S 00A (trasparente/clear)
composizione multipla 12 vetri
multiple configuration 12
accessories
sospensione / pendant
cm Ø 45
3 x max 20W LED



SE134 3T 00C (tiffany)
SE134 3S 00C (trasparente/clear)
composizione multipla 17 vetri
multiple configuration 17
accessories
sospensione / pendant
cm Ø 55
3 x max 20W LED



SE134 1T 00D (tiffany)
SE134 1S 00D (trasparente/clear)
composizione multipla 22 vetri
multiple configuration 22
accessories
sospensione / pendant
cm Ø 60
4 x max 20W LED





CERAUNAVOLTA

design
matteo ugolini
edmondo testaguzza

Struttura in vetro soffiato.
Structure in blown glass.



SE135 5T INT (tiffany)
SE135 5S INT
(trasparente/clear)
sospensione / *pendant*
cm ø 20 h. 23,5
1 x max 33W G9



SE135 3T INT (tiffany)
SE135 3S INT
(trasparente/clear)
sospensione / *pendant*
cm ø 13,5 h. 18
1 x max 33W G9



SE135 1T INT (tiffany)
SE135 1S INT
(trasparente/clear)
sospensione / *pendant*
cm ø 14,5 h. 17
1 x max 33W G9



SE134 3T INT (tiffany)
SE134 3S INT
(trasparente/clear)
sospensione / *pendant*
cm ø 13 h. 12,5
1 x max 33W G9



SE134 4T INT (tiffany)
SE134 4S INT
(trasparente/clear)
sospensione / *pendant*
cm ø 15 h. 17
1 x max 33W G9



SE134 5T INT (tiffany)
SE134 5S INT
(trasparente/clear)
sospensione / *pendant*
cm ø 16 h. 12,5
1 x max 33W G9



DÉJÀ-VU

design matteo ugolini

Struttura in ceramica bianca,
paralume in lino bianco.
*Structure in white ceramic,
shade in white linen.*

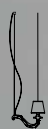

SE627-45B (lucido/glossy)
SE117 3B INT (opaco/matt)
sospensione / *pendant*
cm 45 x 18 x h 32
1 x max 105W E27



SE627-60B (lucido/glossy)
SE117 4B INT (opaco/matt)
sospensione / *pendant*
cm 60 x 25 x h 45
1 x max 105W E27

SR014 3B INT
rosone in metallo per
composizione singola
ceiling cup for single pendant

SR034 1B INT
rosone in metallo per
composizione multipla
*ceiling cup for multiple
configuration*

Versioni disponibili: SOSPENSIONE / APPLIQUE
Available versions: PENDANT / WALL LAMP



DÉJÀ-VU NU

design matteo ugolini

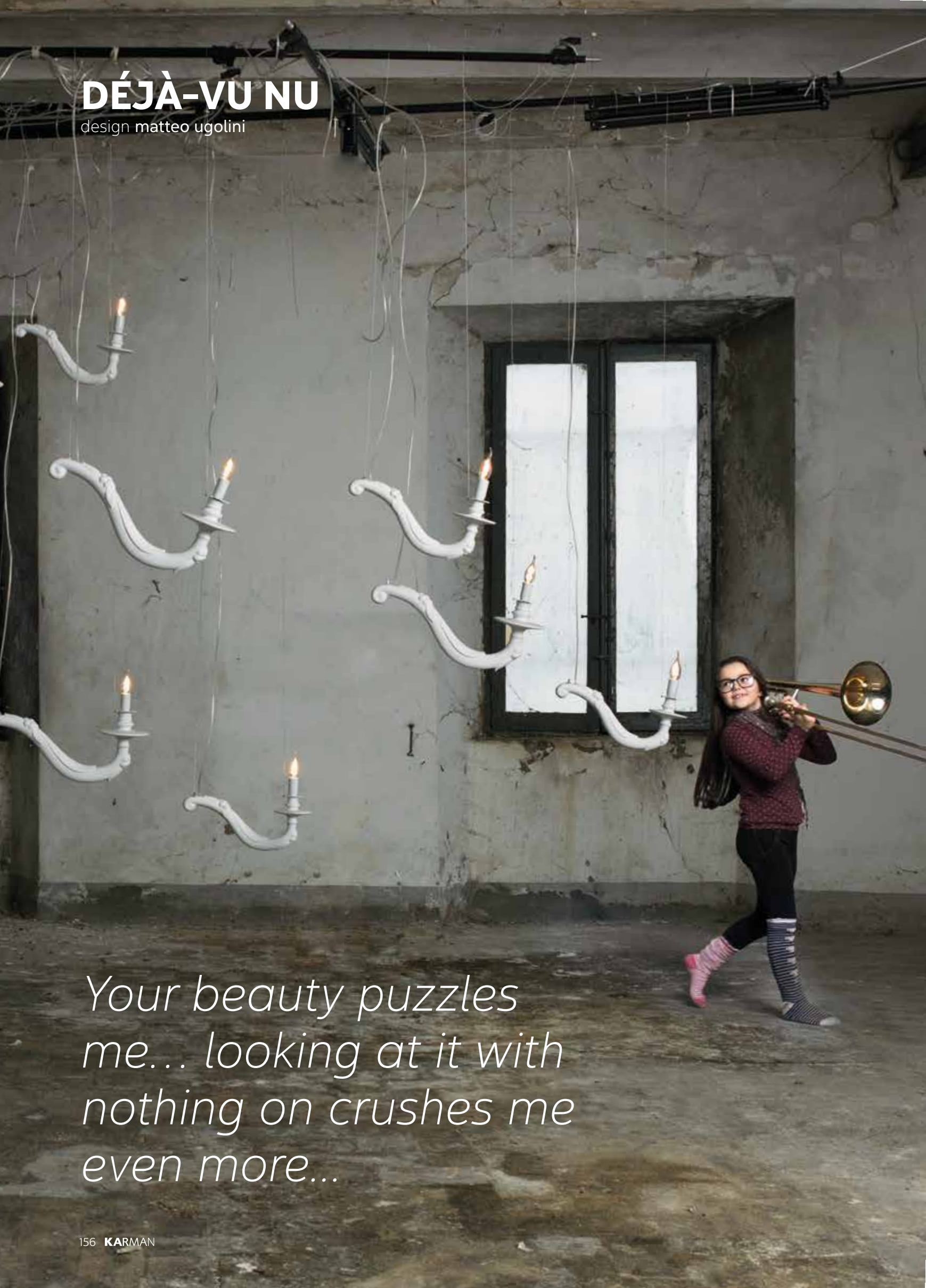

*Your beauty puzzles
me... looking at it with
nothing on crushes me
even more...*



Struttura in ceramica bianca opaca.
Structure in matt white ceramic.

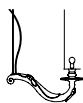

SE117 1B INT
 sospensione / pendant
 cm b.42 p.12 h.25
 1 x max 42W E14

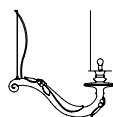

SE117 2B INT
 sospensione / pendant
 cm b.60 p.17 h.32
 1 x max 42W E14

SR014 3B INT
 rosone in metallo per composizione singola
ceiling cup for single pendant

SR034 1B INT
 rosone in metallo per composizione multipla
ceiling cup for multiple configuration

DIES NOX

design laura alesì & silvia braconi

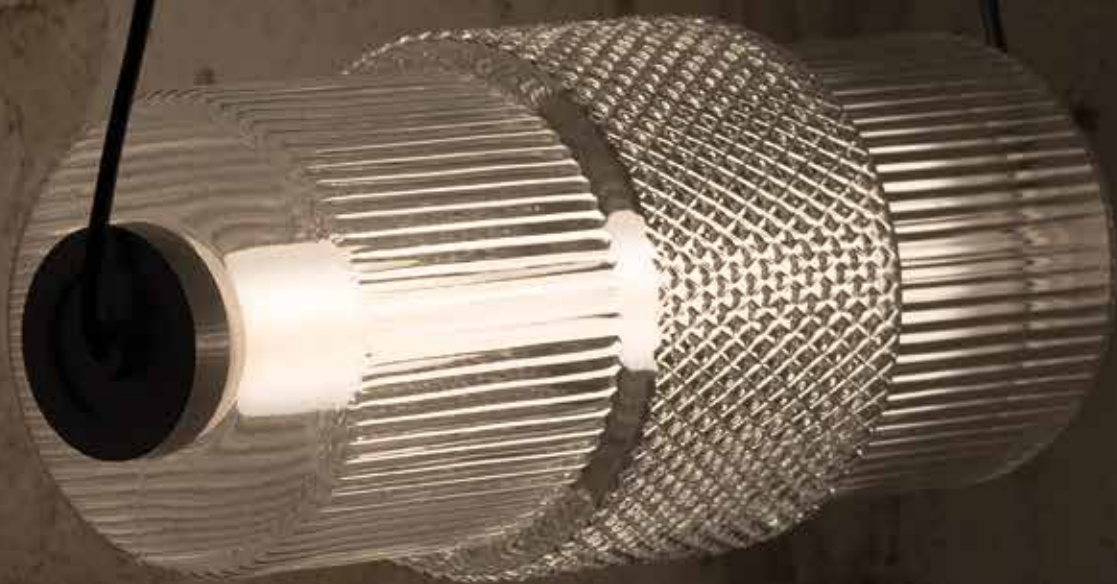

Struttura in vetro.
Structure in glass.



SE124 1T INT (trasparente/clear)
SE124 2N INT (tabacco/tobacco)
sospensione / *pendant*
cm ø 12 l. 36
11W LED, lumen 1060
3000K - dimmerabile / *dimmable*

AC124 3A INT
elemento per composizione multipla
component for horizontal composition

Versioni disponibili: *SOSPENSIONE / OUTDOOR*
Available versions: *PENDANT / OUTDOOR*

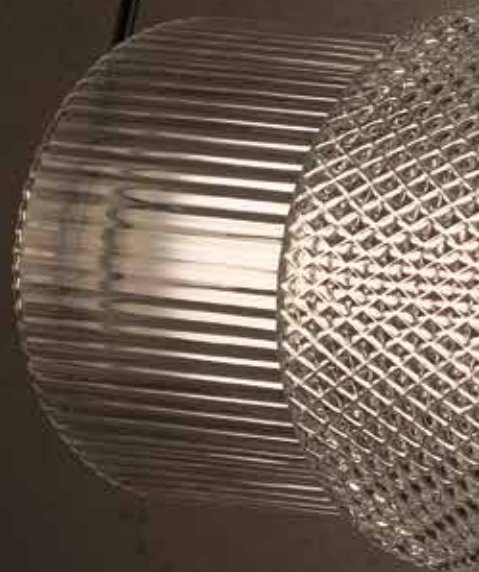



DOMENICA

design luca de bona & dario de meo



*Like a feast day
Breaks up the monotony,
goes beyond the matter,
esplodes in the space
spreading like a melody.*



Struttura in gesso bianco e rete metallica.
Structure in white plaster and wire netting.



(bianco/white) **SE102 1B INT**
(oro/gold) **SE102 1O INT**
sospensione / pendant
cm ø 35 h. 39
1 x max 70W E27



(bianco/white) **SE102 2B INT**
(oro/gold) **SE102 2O INT**
sospensione / pendant
cm ø 50 h. 56
1 x max 70W E27

Versioni disponibili: APPLIQUE / SOSPENSIONE
Available versions: WALL LAMP / PENDANT

GHEBO

design luca de bona & dario de meo





GHEBO

design
luca de bona
dario de meo

Struttura in metallo e vetro trasparente.
Structure in metal and clear glass.

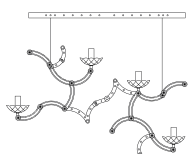

SE146 2B INT (bianco/white)
SE146 2N INT (nero/black)
SE146 2C INT (cromo/chrome)
SE146 2O INT (dorato/gold)

sospensione / *pendant*
cm b.83 x p.11 x h.50
4 x max 42W, E14

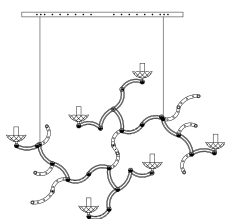

SE146 1B INT (bianco/white)
SE146 1N INT (nero/black)
SE146 1C INT (cromo/chrome)
SE146 1O INT (dorato/gold)

sospensione / *pendant*
cm b.115 x p.11 x h.81
6 x max 42W, E14

Versioni disponibili: APPLIQUE / SOSPENSIONE
Available versions: WALL LAMP / PENDANT





GINGER

design edmondo testaguzza





GINGER

design
edmondo
testaguzza

Struttura in vetro trasparente.
Structure in clear glass.



SE116 2A INT

(paglierino/*pale yellow*)

SE116 2F INT (fumè/*smoked*)

sospensione / *pendant*

cm ø 27 h. 26

1 x max 77W E27



SE116 1A INT

(paglierino/*pale yellow*)

SE116 1F INT (fumè/*smoked*)

sospensione / *pendant*

cm ø 30 h. 20

1 x max 77W E27



SE116 3A INT

(paglierino/*pale yellow*)

SE116 3F INT (fumè/*smoked*)

sospensione / *pendant*

cm ø 30 h. 37

1 x max 77W E27

Versioni disponibili: SOSPENSIONE / OUTDOOR
Available versions: PENDANT / OUTDOOR



KIMONO

design matteo ugolini

*Its shape has no end,
it frays and seems to
melt into the air all
around it, as if light
gains depth.*





Struttura in vetroresina,
Structure in fiberglass.



SE636V-INT
sospensione / pendant
cm ø 40 h. 85
1 x max 105W E27



SE635V-INT
sospensione / pendant
cm ø 50 h. 70
1 x max 105W E27

Versioni disponibili: SOSPENSIONE / OUTDOOR
Available versions: PENDANT / OUTDOOR

LE PUPETTE

design edmondo testaguzza





Struttura in ceramica naturale.
Structure in natural ceramic.



SE131 1B INT
sospensione
pendant
cm Ø 44 h. 32
1 x max 77W E27



SE131 2B INT
sospensione
pendant
cm Ø 30 h. 38
1 x max 77W E27



SE131 3B INT
sospensione
pendant
cm Ø 32 h. 53
1 x max 77W E27

LE TRULLE

design edmondo testaguzza





Struttura in filo metallico e
ceramica naturale.
*Structure in metallic thread and
natural ceramic.*

**SE653T**

sospensione / pendant
cm ø 58 x h. 91
1 x max 70W E27

**SE654T**

sospensione / pendant
cm ø 38 x h. 87
1 x max 70W E27

**SE655T**

sospensione / pendant
cm ø 26 x h. 71
1 x max 70W E27

LIFE

design matteo ugolini





Struttura in metallo color ruggine,
paralume in tessuto denim con finitura vintage.
*Structure in rust metal, shade in fabric
denim with vintage processing.*

**SE650V**

sospensione / pendant
cm ø 36 h 57
1 x max 105W E27

**SE652V**

sospensione / pendant
cm ø 55 h 48
1 x max 105W E27

**SE651V**

sospensione / pendant
cm ø 55 h 48
1 x max 105W E27

Versioni disponibili: APPLIQUE / SOSPENSIONE / PIANTANA TERRA
Available versions: WALL LAMP / PENDANT / FLOOR LAMP

LUCILLA

design matteo ugolini

Struttura in metallo color ruggine.
Structure in rust metal.



SE650VN

sospensione / pendant
cm ø 36 h. 57
1 x max 105W E27



SE651VN

sospensione / pendant
cm ø 55 h. 48
1 x max 105W E27



SE652VN

sospensione / pendant
cm ø 55 h. 48
1 x max 105W E27

Versioni disponibili: SOSPENSIONE / PIANTANA TERRA
Available versions: PENDANT / FLOOR LAMP



MAKEUP

design matteo ugolini

*A light restyling...
and here we have a new
view of the old light bulb
thanks to the smart British
genious Joseph Wilson
Swan 1850.*



MAKEUP

design matteo ugolini

Diffusore in vetro satinato.
Shade in frosted glass.



SE123 1F INT (fumè/smoked)
SE123 1T INT (trasparente/clear)
sospensione / pendant
cm ø 17,5 h. 25
LED 8,6 W 940 lumen,
3000 K

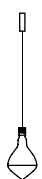

SE123 2F INT (fumè/smoked)
SE123 2T INT (trasparente/clear)
sospensione / pendant
cm ø 17,5 h. 25
LED 8,6 W 940 lumen,
3000 K

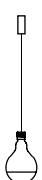

SE123 3F INT (fumè/smoked)
SE123 3T INT (trasparente/clear)
sospensione / pendant
cm ø 15 h. 25
LED 8,6 W 940 lumen,
3000 K

Versioni disponibili: APPLIQUE / SOSPENSIONE
Available versions: WALL LAMP / PENDANT





MEK

design stefano bizzarri & claudio cinti



*A futuristic vision
or a re-use of objects?
Just a luminous illusion?
Mek stands for all that.*





MEK

design
stefano bizzarri
claudio cinti

Struttura in ceramica.
Structure in ceramic.



SE107 3B INT (bianco/white)
SE107 3R INT (bianco
bronzo/white bronze)
SE107 3N INT (nero/black)
sospensione / pendant
cm ø 8 h. 26
1 x max 105W E27



SE107 2B INT (bianco/white)
SE107 2R INT (bianco
bronzo/white bronze)
SE107 2N INT (nero/black)
sospensione / pendant
cm ø 10 h. 25
1 x max 105W E27



SE107 1B INT (bianco/white)
SE107 1R INT (bianco
bronzo/white bronze)
SE107 1N INT (nero/black)
sospensione / pendant
cm ø 17 h. 18
1 x max 105W E27



MOBY DICK

design matteo ugolini

*"All of a sudden the giant
and gibbous proportions
of Moby-Dick shows up on
the sea waves,
a pallor whiteness (...)"
Herman Melville*



Struttura in vetroresina, finitura
esterna liscia, interna naturale.
*Structure in fiberglass, smooth outer
finishing, rough inner finishing.*

**SE646P**

sospensione / pendant
cm 90x30x h. 30
1 x max 70W E27

**SE647G**

sospensione / pendant
cm 150x55x h. 55
1 x max 105W E27

Versioni disponibili: APPLIQUE / SOSPENSIONE / OUTDOOR
Available versions: WALL LAMP / PENDANT / OUTDOOR

MONO

idea di giovanna colapristi –

ABA Verona

coordinamento – sviluppo

prof. sotirios papadopoulos



Struttura in vetroresina bianca
e rete metallica color ruggine.
*Structure in white fiberglass
and wire netting in rust iron.*



SE108 1R INT

sospensione / pendant
cm 51x33 h. 38
1 x max 105W E27





MONO

idea di giovanna colapristi –
ABA Verona
coordinamento – sviluppo
prof. sotirios papadopoulos



Struttura in vetroresina bianca
e rete metallica color ruggine.
*Structure in white fiberglass
and wire netting in rust iron.*



SE108 1R INT
sospensione / *pendant*
cm 51x33 h. 38
1 x max 105W E27



NANDO

design luca de bona & dario de meo

*An intimate homage to
Ferdinando Innocenti.*





NANDO
design
luca de bona
dario de meo





Struttura in metallo.
Structure in metal.



SE109 1G INT (antracite/
charcoal grey)

SE109 1B INT (bianco/*white*)

SE109 1O INT (oro/*gold*)

sospensione / *pendant*

cm 8x11,5 h. 35

1 x max 77W E27



SE109 2G INT (antracite/
charcoal grey)

SE109 2B INT (bianco/*white*)

SE109 2O INT (oro/*gold*)

sospensione / *pendant*

cm 8x11,5 h. 15

1 x max 77W E27

Versioni disponibili: APPLIQUE / SOSPENSIONE
Available versions: WALL LAMP / PENDANT

NORMA M

design edmondo testaguzza

Struttura in ceramica bianca opaca,
paralume in lino bianco.
*Structure in matt white ceramic,
shade in white linen.*



SE640EB

elemento bianco per sospensione multipla,
altezza regolabile
*white element for multiple composition,
adjustable in height*
cm ø 22 h. 40
1 x max 52W E27

SR064 1B INT

rosone in metallo per composizione multipla
ceiling cup for multiple configurations

SR001 3B INT

rosone in metallo per composizione singola
ceiling cup for single pendant

Versioni disponibili: APPLIQUE / SOSPENSIONE / TAVOLO / PIANTANA TERRA
Available versions: WALL LAMP / PENDANT / TABLE LAMP / FLOOR LAMP



NOTREDAME

design luca de bona & dario de meo



Struttura in tecnopolimero bianco.
Structure in white techno-polymer.

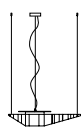

SE130 4B INT (3000K)
SE130 6B INT (2700K)
sospensione
pendant
cm h. 63 b. 56 p. 11

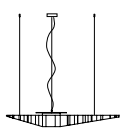

SE130 3B INT (3000K)
SE130 5B INT (2700K)
sospensione
pendant
cm h. 98 b. 83 p. 11

Struttura in tecnopolimero oro.
Structure in gold techno-polymer.

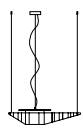

SE130 4O INT (3000K)
SE130 6O INT (2700K)
sospensione
pendant
cm h. 63 b. 56 p. 11

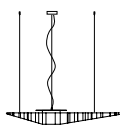

SE130 3O INT (3000K)
SE130 5O INT (2700K)
sospensione
pendant
cm h. 98 b. 83 p. 11

LED frontale / Front LED
13W, 1520 lumen, CRI > 80
Dimmerabile / Dimmable
Strip LED retroilluminazione
backlight
3W, 280 lumen, CRI > 80
Dimmerabile / Dimmable

Versioni disponibili:
APPLIQUE / SOSPENSIONE / PLAFONIERA
Available versions:
WALL LAMP / PENDANT / CEILING LAMP

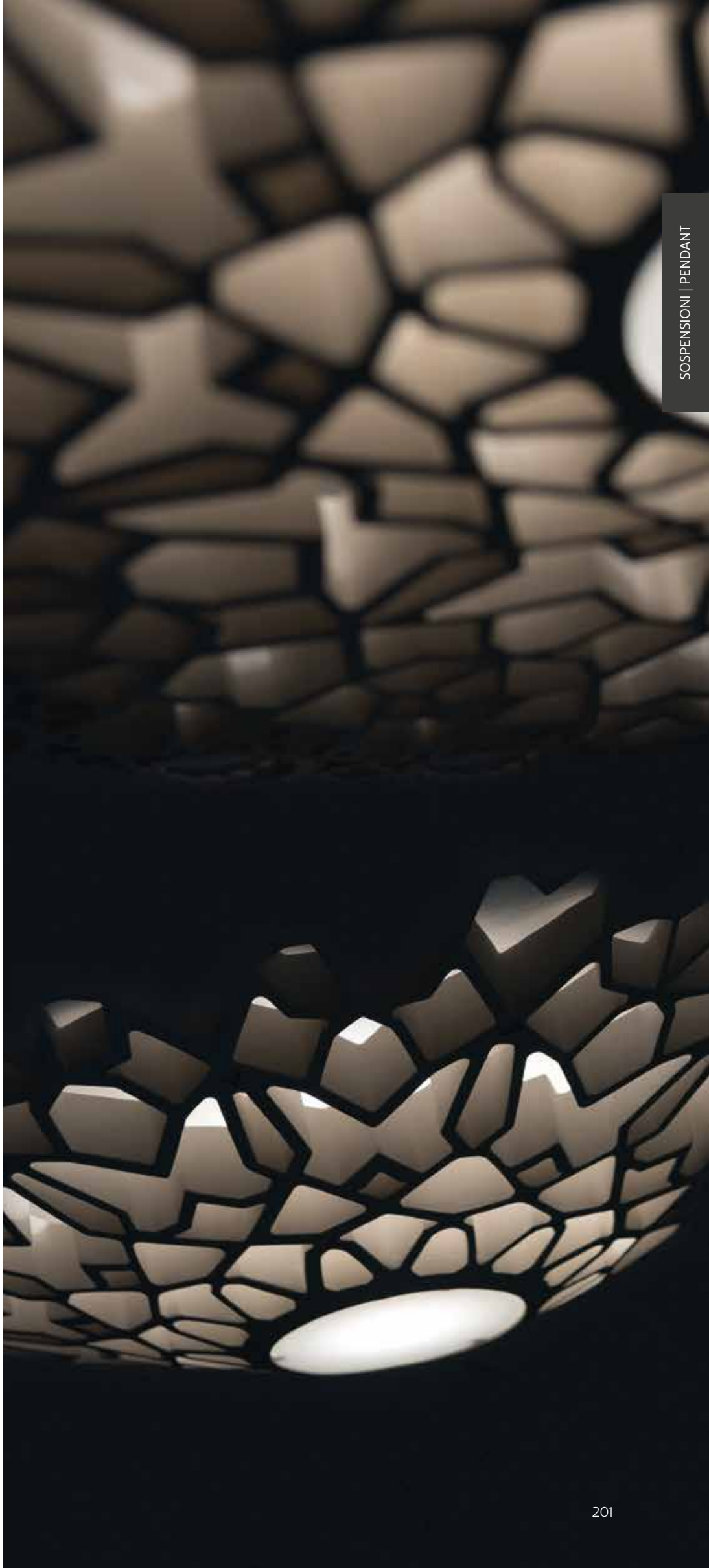

PLANCTON

design matteo ugolini



Struttura in vetroresina con bordi sfrangiati.
Structure in fiberglass with unfinished borders.



SE648/1PB

sospensione / pendant
cm ø 45 h. 25
1 x max 70W E27



SE649/1GB

sospensione / pendant
cm ø 75 h. 40
1 x max 105W E27

Versioni disponibili: SOSPENSIONE / OUTDOOR
Available versions: PENDANT / OUTDOOR



SAHARA

design matteo ugolini



Struttura in ceramica finitura lucida.
Structure in glossy ceramic.



SE667KB (bianco/white)
SE667KV (verde/green)
sospensione / pendant
cm ø 14 h. 40
1 x max 70W E27



SE668KB (bianco/white)
SE668KV (verde/green)
sospensione / pendant
cm ø 23 h. 17
1 x max 70W E27



SE669KB (bianco/white)
SE669KV (verde/green)
sospensione / pendant
cm ø 29 h. 35
1 x max 70W E27



SE670KB (bianco/white)
SE670KV (verde/green)
sospensione / pendant
cm ø 35 h. 24
1 x max 70W E27



SAHARA
design
matteo ugolini





SCRIVIMI

design matteo ugolini





Struttura in ceramica bianca.
Structure in white ceramic.



SE111 2B INT

sospensione / pendant
cm ø 35 h. 14
1 x max 70W E27



SE111 1B INT

sospensione / pendant
cm ø 47 h. 20
1 x max 70W E27

SETTENANI COLLECTION

design matteo ugolini





**SETTENANI
COLLECTION**

design
matteo ugolini





Struttura in cemento grigio tortora.
Structure in dove grey concrete.



SE686N6 (PISOLO)

sospensione
pendant
cm ø 23 h. 20
1 x max 70W E27



SE681N1 (EOLO)

sospensione
pendant
cm ø 24 h. 34
1 x max 70W E27



SE685N5 (MAMMOLO)

sospensione
pendant
cm ø 24 h. 23
1 x max 70W E27



SE683N3 (BRONTOLO)

sospensione
pendant
cm ø 26 h. 36
1 x max 70W E27



SE687N7 (GONGOLO)

sospensione
pendant
cm ø 26 h. 14
max 1x70W E27



SE688N7 (BIANCALUCE)

sospensione
pendant
cm ø 34 h. 44
1 x max 70W E27

Versioni disponibili: SOSPENSIONE / OUTDOOR
Available versions: PENDANT / OUTDOOR

SHERWOOD E ROBIN

design matteo ugolini



Struttura in ceramica bianca opaca.
Structure in matt white ceramic.



SE151 AB INT

sospensione / pendant
cm Ø8 x h 11,5
(Sherwood-ghianda/acorn)
1 x max 53W E27



SE151 BB INT

sospensione / pendant
cm Ø8 x h 11,5
(Sherwood-ghianda/acorn)
1 x max 53W E27
cm 8 x 9 x h 44
(Robin-scoiattolo/squirrel)



SE151 CB INT

sospensione / pendant
cm Ø8 x h 11,5
(Sherwood-ghianda/acorn)
1 x max 53W E27
cm 8 x 9 x h 44
(Robin-scoiattolo/squirrel)



**SHERWOOD
E ROBIN**
design matteo ugolini





SISMA
design matteo ugolini





Struttura in tondino
metallico verniciato nervato.
*Structure in construction
site's ribbed rebar.*

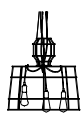

SE112 1T INT
(naturale/natural)
SE112 1B INT
(bianco/white)
sospensione / *pendant*
cm Ø 60 h. 60
3 x max 77W E27

Versioni disponibili:
SOSPENSIONE / PIANTANA TERRA
Available versions:
PENDANT / FLOOR LAMP

SNOOB

design matteo ugolini



Struttura in alluminio laccato.
Structure in lacquered aluminium.



SE609B (bianco/white)
SE609N (nero/black)
sospensione a 16 bracci
pendant with 16 arms
cm ø 130 h. 45
32 x max 42W E14



SE610B (bianco/white)
SE610N (nero/black)
sospensione a 8 bracci
pendant with 8 arms
cm ø 73 h. 35
16 x max 42W E14



T-BLACK

design edmondo testaguzza

*A simple, basic,
almost primordial
style. A unique
sensorial
experience.*



Struttura in gres antracite opaco,
interno in smalto bianco lucido.
*Structure in matt charcoal
stoneware, inner in glossy white.*

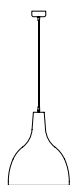

SE150 AN INT
sospensione
pendant
cm Ø24 x h 27
1 x max 53W
E27

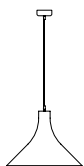

SE150 BN INT
sospensione
pendant
cm Ø27,5 x h 20
1 x max 53W E27

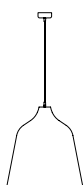

SE150 CN INT
sospensione
pendant
cm Ø31 x h 32
1 x max 70W E27



TORCIA

design matteo ugolini



Struttura in tecnopolimero grigio opaco.
Structure in matt grey techno-polymer.



SE155 EG INT
sospensione
pendant
cm Ø40
13 x max 5W LED GU10



SE155 AG INT
sospensione
pendant
cm Ø9
1 x max 5W LED GU10



SE155 CG INT
sospensione
pendant
cm Ø20
3 x max 5W LED GU10

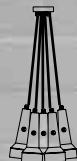

SE155 DG INT
sospensione
pendant
cm Ø28
7 x max 5W LED GU10

Versioni disponibili: SOSPENSIONE / PIANTANA TERRA / OUTDOOR
Available versions: PENDANT / FLOOR LAMP / OUTDOOR



ULULÌ ULULÀ

design matteo ugolini

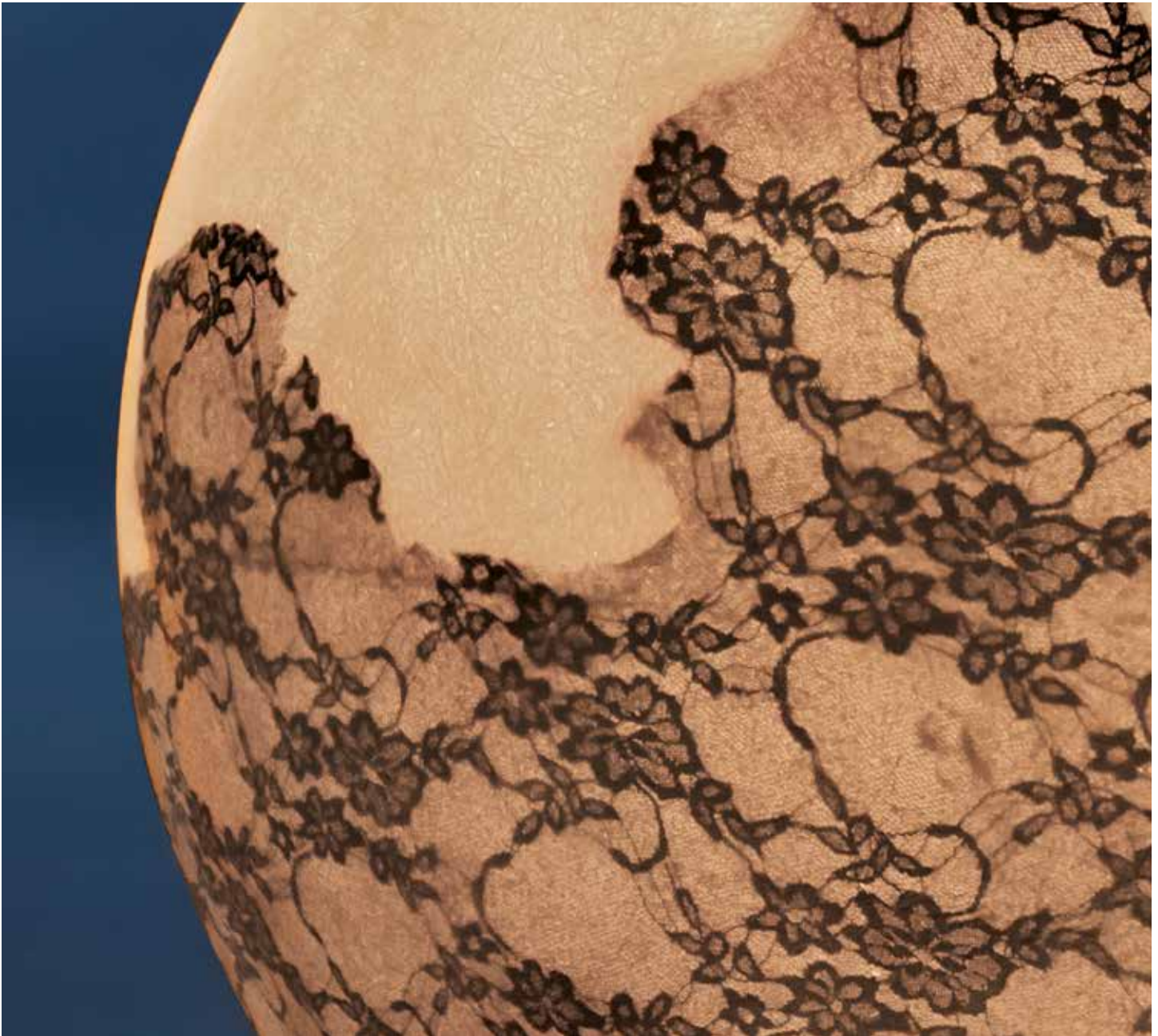

*We give you the
Moon: inspiring
art, projects
and dreams...*



Struttura in vetroresina con inserti in pizzo.
Structure in fiberglass with lace inserts.

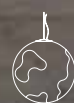

SE648PB (ULULÌ)
sospensione / pendant
cm ø 45
1 x max 70W E27



SE649GB (ULULÀ)
sospensione / pendant
cm ø 75
1 x max 105W E27

Versioni disponibili: SOSPENSIONE / PIANTANA TERRA / OUTDOOR
Available versions: PENDANT / FLOOR LAMP / OUTDOOR

VIA RIZZO 7

design matteo ugolini



Struttura in ceramica opaca.
Structure in matt ceramic.



SE694PB
sospensione / pendant
cm ø 33 h. 33
1 x max 70W E27



SE695GB
sospensione / pendant
cm ø 40 h. 40
1 x max 70W E27

Struttura e decorazione in ceramica bianca.

Structure and decoration in matt white ceramic.



SE694PB

sospensione
pendant
cm ø 33 h. 33
1 x max 70W E27



SE695GB

sospensione
pendant
cm ø 40 h. 40
1 x max 70W E27

Accessorio in ceramica bianca opaca.
Optional in matt white ceramic.



100SE695G

cm h. 19



100SE694P

cm h. 10



WORK IN PROGRESS

design matteo ugolini





Struttura in ceramica bianca.
Structure in white ceramic.



SE125 1B INT

sospensione
pendant

cm h. 39 p. 10
1 x max 35W GU10

SR001 3B INT

rosone in metallo per
composizione singola
ceiling cup for single pendant

SR025 1B INT

rosone in metallo per
composizione multipla
ceiling cup for multiple
configuration

Versioni disponibili: APPLIQUE / SOSPENSIONE
Available versions: WALL LAMP / PENDANT

WORK IN PROGRESS

design matteo ugolini

Struttura in ceramica bianca.
Structure in white ceramic.



SE125 1B INT
sospensione / *pendant*
cm h. 39 p. 10
1 x max 35W GU10

SR001 3B INT
rosone in metallo per
composizione singola
*ceiling cup for single
pendant*

SR025 1B INT
rosone in metallo per
composizione multipla
*ceiling cup for multiple
configuration*

Versioni disponibili: APPLIQUE / SOSPENSIONE
Available versions: WALL LAMP / PENDANT





WOW!

design matteo ugolini

*It is supposed to be the
provocation, wonder,
surprise and a friendly invitation
to step out of a frame
of mind just in a 'click' of light.*





Paralume in lino bianco e
 accessorio in ceramica bianca opaca.
*Shade in white linen and optional in
 matt white ceramic.*



SE696CC
 sospensione
 pendante
 cm ø 60 h. 40
 1 x max 70W E27



SE697CO
 Accessorio "Silvan"
 Optional "Silvan"
 cm b. 46 h. 26.





WOW!

design matteo ugolini

Paralume in lino bianco e
accessorio in ceramica bianca opaca.
*Shade in white linen
and optional in matt white ceramic.*

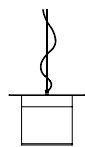

SE696CC
sospensione
pendant
cm ø 60 h. 40
max 1x70W E27



SE697CO
Accessorio "Silvan".
Optional "Silvan".
cm b. 46 h. 26



**AP
PLI
QUE**
wall lamp

ALIBABIG

design matteo ugolini



Struttura in vetroresina.
Structure in fiberglass.



H625V-INT

piantana / applique
floor / wall lamp
cm 73x48 h. 130
4 x max 23W E27

Versioni disponibili: APPLIQUE / SOSPENSIONE
/ PIANTANA TERRA / OUTDOOR
Available versions: WALL LAMP / PENDANT /
FLOOR LAMP / OUTDOOR

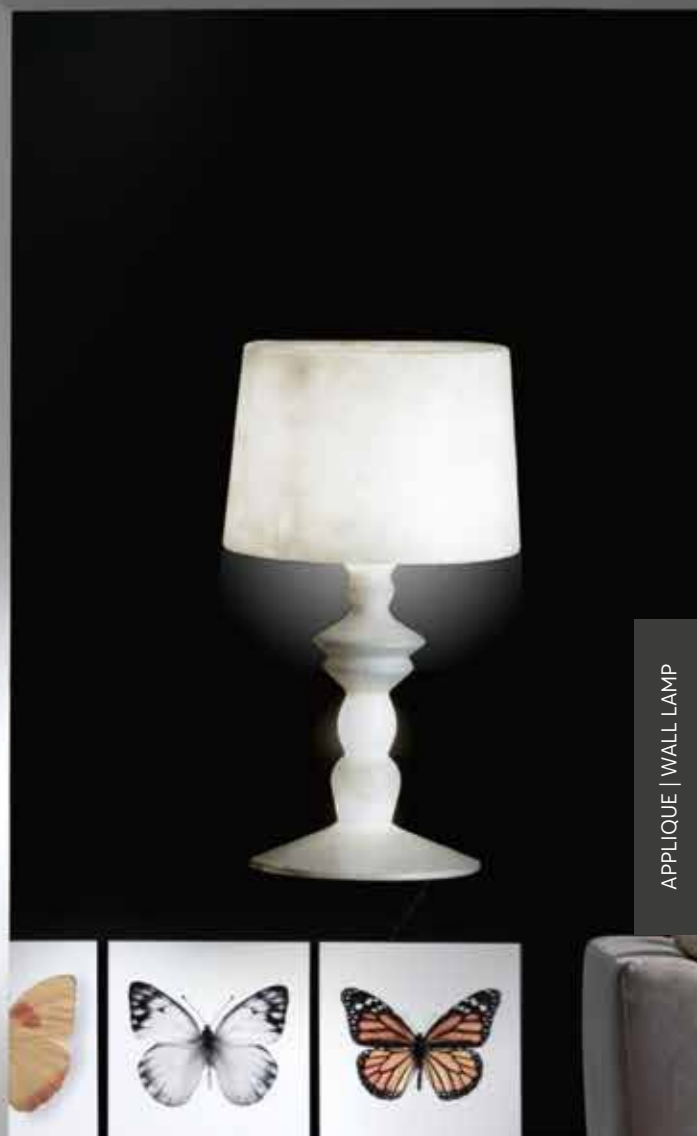

APPLIQUE | WALL LAMP



AMARCORD

design matteo ugolini



Struttura in cemento bianco
e diffusore in vetro.
*Structure in white concrete
and shade in glass.*



AP121 1B INT (trasparente/clear)
AP121 BF INT (fumè/smoked)
AP121 BS INT (trasparente
satinato/clear frosted)
applique / wall lamp
cm 12x13 h. 38
1 x max 52W E27

Struttura in cemento grigio tortora
e diffusore in vetro.
*Structure in dove grey concrete
and shade in glass.*



AP121 GT INT (trasparente/clear)
AP121 1G INT (fumè/smoked)
AP121 GS INT (trasparente
satinato/clear frosted)
applique / wall lamp
cm 12x13 h. 38
1 x max 52W E27

Versioni disponibili: APPLIQUE / TAVOLO
Available versions: WALL LAMP / TABLE LAMP



APRILE

design matteo ugolini



Struttura in ceramica bianca.
Structure in white ceramic.



AP132 1B INT
applique / wall lamp
cm 50x18 h 35
1 x max 52W E27



APPLIQUE | WALL LAMP

BRAILLE

design matteo ugolini



*A sphere, which needs
to be simple but complex,
fun but pure... as friendship.*



APPLIQUE | WALL LAMP

Struttura in vetro bianco satinato.
Structure in white frosted glass.



PL144 1B INT
applique / wall lamp
cm Ø25 x h 25
1 x max 46W, E14



PL144 2B INT
applique / wall lamp
cm Ø40 x h 38
1 x max 105W, E27

Versioni disponibili: APPLIQUE / TAVOLO / SOSPENSIONE / PLAFONIERA
Available versions: WALL LAMP / TABLE LAMP / PENDANT / CEILING LAMP

CAPODIMONTE

design matteo ugolini



Struttura in ceramica bianca opaca.
Structure in matt white ceramic.



AP129 1B INT

applique / wall lamp
cm h. 26 p. 13 ø 6
1 x max 35W GU10

Versioni disponibili: APPLIQUE / SOSPENSIONE
Available versions: WALL LAMP / PENDANT



APPLIQUE | WALL LAMP

CUBANO

design matteo ugolini



Struttura in ceramica bianca opaca.
Structure in matt white ceramic.



AP142 1B INT

applique / wall lamp
cm b.47 x p.20 x h.45
1 x max 52W, E27



DÉJÀ-VU

design matteo ugolini



*To see again
tradition and let it
float in the air.*



Struttura in ceramica bianca,
paralume in lino bianco.
*Structure in white ceramic,
shade in white linen.*



AP627-45B (lucido/glossy)

AP117 3B INT (opaco/matt)

applique braccio piccolo / wall lamp
cm 45x18 h. 32
1 x 52W E27



AP627-60B (lucido/glossy)

AP117 4B INT (opaco/matt)

applique braccio grande / wall lamp
cm 60x25 h. 45
1 x 52W E27

Versioni disponibili: APPLIQUE / SOSPENSIONE
Available versions: WALL LAMP / PENDANT

DOMENICA

design luca de bona & dario de meo

Struttura in gesso bianco e rete metallica.
Structure in white plaster and wire netting.



AP102 1B INT (bianca/white)

AP102 1O INT (oro/gold)

applique / wall lamp

cm 35x17,5 h. 39

1 x max 52W E27

Versioni disponibili: APPLIQUE / SOSPENSIONE
Available versions: WALL LAMP / PENDANT

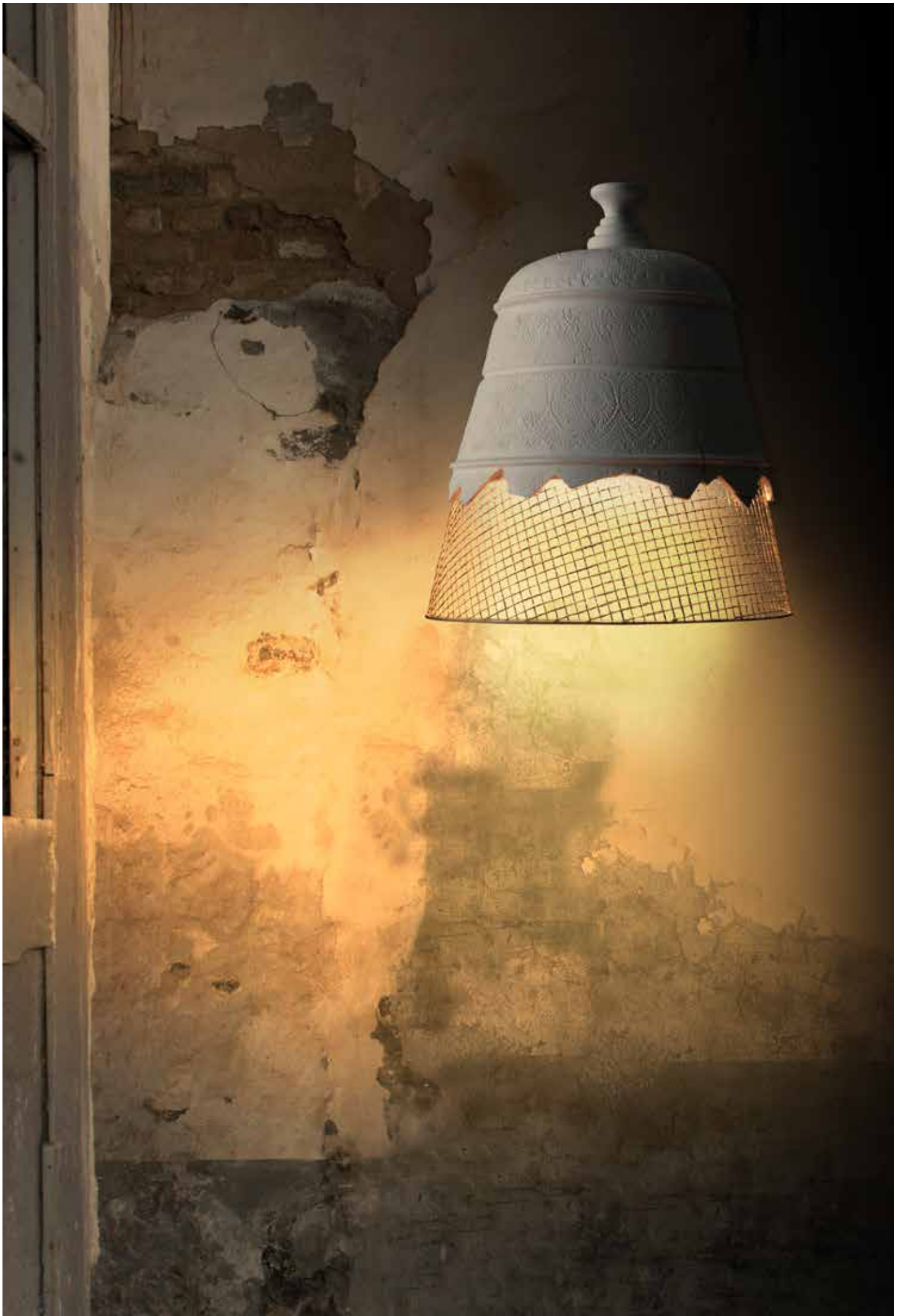

APPLIQUE | WALL LAMP

EDEN COLLECTION

design matteo ugolini





Struttura in ferro con diffusore
in lycra bianco.
*Iron structure with shade
in white synthetic fiber (lycra).*



AP103 3B INT "EVA"

applique / plafoniera
wall lamp / ceiling lamp
cm h 46,5 b 30 p 16
1 x max 46W E27



AP103 2B INT "ADAMO"

applique / plafoniera
wall lamp / ceiling lamp
cm h 72 b 38 p 19
2 x max 46W E27



AP103 1B INT "EDEN"

applique / plafoniera
wall lamp / ceiling lamp
cm h 115 b 82 p 23
3 x max 46W E27

Versioni disponibili: APPLIQUE / PLAFONIERA
Available versions: WALL LAMP / CEILING LAMP

GHEBO

design luca de bona & dario de meo



*Inspired by the
reflections of the
sun on the network
of the water canals
in Venice*



Struttura in metallo e vetro trasparente.
Structure in metal and clear glass.



AP146 3B INT (bianco/white)
AP146 3N INT (nero/black)
AP146 3C INT (cromo/chrome)
AP146 3O INT (dorato/gold)

applique / wall lamp
cm b.49 x p.14 x h.35
2 x max 42W, E14

Versioni disponibili: APPLIQUE / SOSPENSIONE
Available versions: WALL LAMP / PENDANT

GHEBO
design
luca de bona
dario de meo





APPLIQUE | WALL LAMP

LIFE

design matteo ugolini



Struttura in ferro color ruggine, rivestimento tessuto denim con finitura vintage.
Structure in rust iron fabric denim with vintage processing.



AP652V
applique / wall lamp
cm l. 43 p. 23 h. 36
1 x max 70W E27

Versioni disponibili: APPLIQUE / SOSPENSIONE / PIANTANA TERRA
Available versions: WALL LAMP / PENDANT / FLOOR LAMP

MAKEUP

design matteo ugolini





Diffusore in vetro satinato.
Shade in frosted glass.

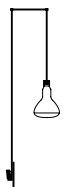

AP123 1F INT (fumè/smoked)
AP123 1T INT (trasparente/clear)
applique / wall lamp
cm ø 17,5 h. 25
LED 8,6 W, 940 lumen,
3000 K

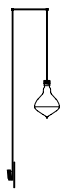

AP123 2F INT (fumè/smoked)
AP123 2T INT (trasparente/clear)
applique / wall lamp
cm ø 17,5 h. 25
LED 8,6 W, 940 lumen,
3000 K

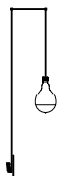

AP123 3F INT (fumè/smoked)
AP123 3T INT (trasparente/clear)
applique / wall lamp
cm ø 15 h. 25
LED 8,6 W, 940 lumen,
3000 K

Versioni disponibili: APPLIQUE / SOSPENSIONE
Available versions: WALL LAMP / PENDANT

MARNÌN
design matteo ugolini



Struttura in ceramica bianca opaca.
Structure in matt white ceramic.



AP645M
applique / wall lamp
cm 36x43 p 37
1 x max 70W E27



APPLIQUE | WALL LAMP

MOBY DICK

design matteo ugolini





Struttura in vetroresina, finitura esterna liscia
interna naturale.
*Structure in fiberglass, smooth outer finishing
rough inner finishing.*



AP646P

applique / wall lamp
cm 90X30 h.30
2 x max 52W E27

Versioni disponibili: APPLIQUE / SOSPENSIONE / OUTDOOR
Available versions: WALL LAMP / PENDANT / OUTDOOR

APPLIQUE | WALL LAMP

NANDO

design luca de bona & dario de meo



Struttura in metallo.
Structure in metal.

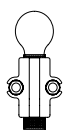

AP109 2B INT (bianco/white)
AP109 2G INT (antracite/
charcoal-grey)
AP109 2O INT (oro/gold)
applique / wall lamp
cm 9x11,5 h 15
1 x max 52W E27

Versioni disponibili: APPLIQUE / SOSPENSIONE
Available versions: WALL LAMP / PENDANT



NORMA M

design edmondo testaguzza



Struttura in ceramica bianca opaca,
paralume in lino bianco.
*Structure in matt white ceramic,
shade in white linen.*

**AP640B**

applique, altezza regolabile
wall lamp, adjustable in height
cm ø 22 h. 40
1x max 52W E27

Versioni disponibili: APPLIQUE / SOSPENSIONE / TAVOLO / PIANTANA TERRA
Available versions: WALL LAMP / PENDANT / TABLE LAMP / FLOOR LAMP

NOTREDAME

design luca de bona & dario de meo

*Recall the main
appeal of natural
light spreading
out through rose
windows of Gothic
cathedrals...*





APPLIQUE | WALL LAMP



NOTREDAME

design
luca de bona
dario de meo

Struttura in tecnopolimero bianco.
Structure in white techno-polymer.



PL130 4B INT (3000K)
PL130 6B INT (2700K)
plafoniera/applique
ceiling/wall lamp
cm h. 63 b. 56 p. 11

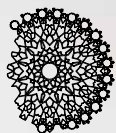

PL130 3B INT (3000K)
PL130 5B INT (2700K)
plafoniera/applique
ceiling/wall lamp
cm h. 98 b. 83 p. 11

LED frontale / *Front LED*
13W, 1520 lumen, CRI > 80
Dimmerabile / *Dimmable*
Strip LED retroilluminazione
backlight
3W, 280 lumen, CRI > 80
Dimmerabile / *Dimmable*

Versioni disponibili: APPLIQUE / SOSPENSIONE / PLAFONIERA
Available versions: WALL LAMP / PENDANT / CEILING LAMP





NOTREDAME

design
luca de bona
dario de meo

Struttura in tecnopolimero oro.
Structure in gold techno-polymer.

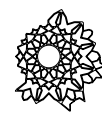

PL130 40 INT (3000K)
PL130 60 INT (2700K)
plafoniera/applique
ceiling/wall lamp
cm h. 63 b. 56 p. 11

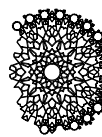

PL130 30 INT (3000K)
PL130 50 INT (2700K)
plafoniera/applique
ceiling/wall lamp
cm h. 98 b. 83 p. 11

LED frontale / *Front LED*
13W, 1520 lumen, CRI > 80
Dimmerabile / *Dimmable*
Strip LED retroilluminazione
backlight
3W, 280 lumen, CRI > 80
Dimmerabile / *Dimmable*

Versioni disponibili:
APPLIQUE / SOSPENSIONE / PLAFONIERA
Available versions:
WALL LAMP / PENDANT / CEILING LAMP



APPLIQUE | WALL LAMP

PORCAMISERIA

design matteo ugolini





Struttura in ceramica bianca opaca.
Structure in matt white ceramic.



AP656B

applique
wall lamp

cm ø 40 p. 40
5 x max 28W E27

QUARANTASEI

design matteo ugolini



*“Devoted to who wrote
the history of the sport.
To my hero.”*

Matteo Ugolini



QUARANTASEI

design matteo ugolini

Struttura in cemento grigio tortora
e vetro satinato.

*Structure in dove grey concrete
and frosted glass.*

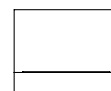

AP 140 1G EXT

applique / wall lamp
cm b. 25 x h. 20 x p. 17
1 x max 8W LED, R7S
800 lumen - IP44

Accessorio in acciaio bianco opaco.
Optional in matt white steel.

0

AC140 0B INT

accessorio numero 0
optional number 0
cm h.10

1

AC140 1B INT

accessorio numero 1
optional number 1
cm h.10

2

AC140 2B INT

accessorio numero 2
optional number 2
cm h.10

3

AC140 3B INT

accessorio numero 3
optional number 3
cm h.10

4

AC140 4B INT

accessorio numero 4
optional number 4
cm h.10

5

AC140 5B INT

accessorio numero 5
optional number 5
cm h.10

6

AC140 6B INT

accessorio numero 6
optional number 6
cm h.10

7

AC140 7B INT

accessorio numero 7
optional number 7
cm h.10

8

AC140 8B INT

accessorio numero 8
optional number 8
cm h.10

9

AC140 9B INT

accessorio numero 9
optional number 9
cm h.10

Altri accessori disponibili: A,B,C,D,E,F,G,/.
Optional also available: A,B,C,D,E,F,G,/.

Versioni disponibili: APPLIQUE / OUTDOOR
Available versions: WALL LAMP / OUTDOOR

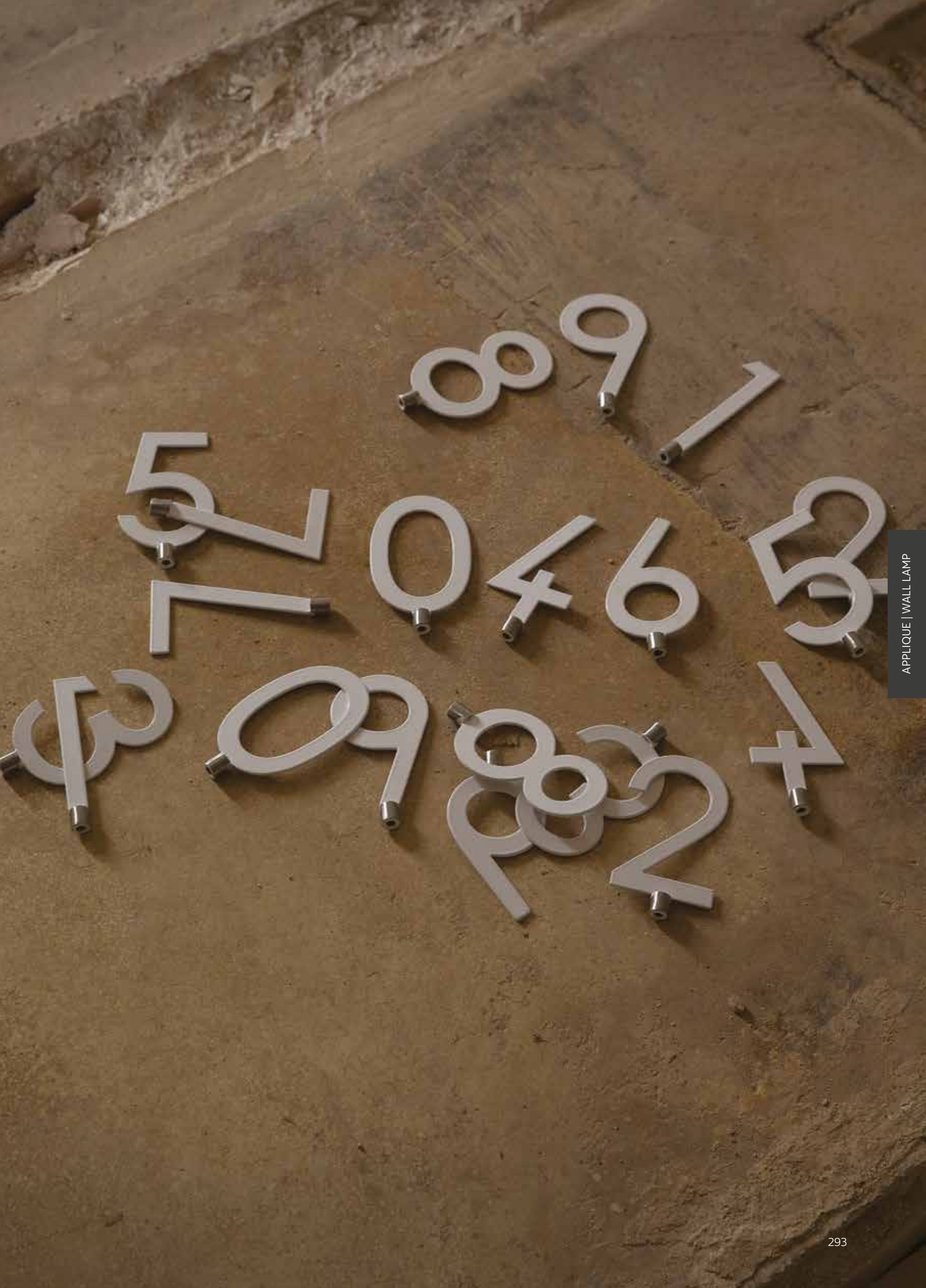

APPLIQUE | WALL LAMP

TI VEDO

design matteo ugolini



*The first lamp able to
turn the tide: instead of looking
at a light object...
now light is looking at you!*



Struttura in ceramica bianca opaca.
Structure in matt white ceramic.

AP105 1B INT
applique / wall lamp
cm p.20 b.36 h.40
2 x max 53W E27

Versioni disponibili: APPLIQUE / TAVOLO
Available versions: WALL LAMP / TABLE LAMP

UGO RILLA

design matteo ugolini

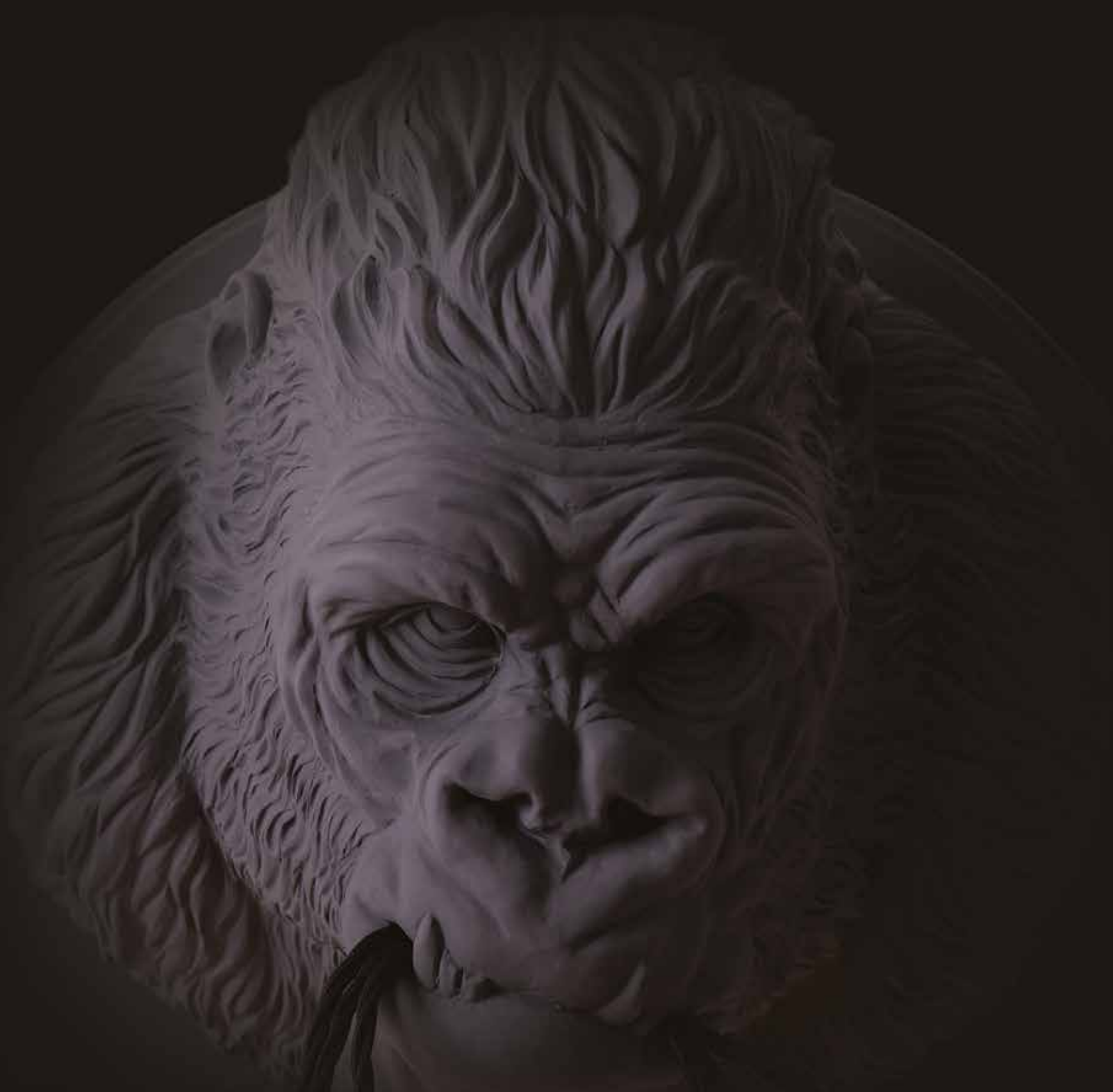



Struttura in ceramica grigia opaca.
Structure in matt grey ceramic.



AP152 GR INT
applique / wall lamp
cm Ø41,5 x p 24
3 x max 10W LED E27*

*sono consigliate lampadine in plastica
** we recommend to use plastic light bulbs*

UGO RILLA
design matteo ugolini



Struttura in ceramica bianca opaca.
Structure in matt white ceramic.



AP152 BB INT
applique / wall lamp
cm Ø41,5 x p 24
3 x max 10W LED E27*

*sono consigliate lampadine in plastica
** we recommend to use plastic light bulbs*



APPLIQUE | WALL LAMP

VA-LENTINA

design matteo ugolini



Struttura in alluminio laccato bianco
e lumaca in ceramica bianca opaca.
*Structure in white lacquered aluminium
and snail in matt white ceramic.*

**AP115 OB INT**

applique / wall lamp
cm 30x17 h. 20
2x8,4W LED, 960 lumen, 3000k

**AC115 OB INT**

accessorio / optional
cm b.10 p.5 h.6

WORK IN PROGRESS

design matteo ugolini

*It enters on tiptoe
in the most refined and
intimate spaces.*





Struttura in ceramica bianca opaca.
Structure in matt white ceramic.



AP125 1B INT
applique / wall lamp
cm 12x14 h 39
1 x max 35W GU10

Versioni disponibili: APPLIQUE / SOSPENSIONE
Available versions: WALL LAMP / PENDANT



**TA
VOLO**
table lamp

AMARCORD

design matteo ugolini



*Undress an object
from ancient times,
seize all its essential lines
to set it at its ease
in contemporary spaces.*

Struttura in cemento bianco e diffusore in vetro.
Structure in white concrete and shade in glass.



CT121 1B INT (trasparente/clear)
CT121 BF INT (fumè/smoked)
CT121 BS INT (trasparente satinato/
clear frosted)

lampada da tavolo / *table lamp*
cm Ø12 x h. 38
1 x max 52W E27

Versioni disponibili: APPLIQUE / TAVOLO
Available versions: WALL LAMP / TABLE LAMP



AMARCORD
design matteo ugolini





Struttura in cemento grigio tortora e diffusore in vetro.
Structure in dove grey concrete and shade in glass.



CT121 GT INT (trasparente/clear)
CT121 1G INT (fumè/smoked)
CT121 GS INT (trasparente satinato/
clear frosted)

lampada da tavolo / *table lamp*
cm Ø12 x h. 38
1 x max 52W E27

Versioni disponibili: APPLIQUE / TAVOLO
Available versions: WALL LAMP / TABLE LAMP

BACCO

design matteo ugolini





Struttura in vetro bianco satinato.
Structure in white frosted glass.



CT143 1B INT (3000K)
CT143 2B INT (2700K)
lampada da tavolo / *table lamp*
cm Ø9 x h.34
LED 3,3 W 250 lumen
alimentata a batterie ricaricabili
autonomia batterie 6 ore
*rechargeable batteries with
6 hours autonomy*

Versioni disponibili: TAVOLO / SOSPENSIONE
Available versions: TABLE LAMP / PENDANT

BACCO
design matteo ugolini





PERBACCO

design matteo ugolini

Struttura in tondino metallico
laccato in polietilene grigio chiaro.

*Structure in metal rebar
light grey polyethylene lacquered.*



AC143 2G INT

accessorio cestino / *basket optional*
cm b.32 x p.22 x h.32

BAG

design baldessari e baldessari



Struttura in ceramica liscia lucida
e manico in metallo verniciato grigio.
*Structure in smooth glossy ceramic
and handle in grey metal.*



CT154 CB INT (bianca/white)

CT154 CR INT (bronzo/bronze)

lampada da tavolo / table lamp

cm 21 x 22 x h 21,5

1 x max 5W LED E27*



*si consiglia l'utilizzo di lampadina bianco latte
**white milk bulb is recommended*

Versioni disponibili: TAVOLO / SOSPENSIONE / PIANTANA TERRA
Available versions: TABLE LAMP / PENDANT / FLOOR LAMP

Struttura in ceramica lucida con texture
e manico in metallo verniciato grigio
*Structure in glossy ceramic with texture
and handle in grey metal.*



CT154 DB INT (bianca/white)
CT154 DR INT (bronzo/bronze)



lampada da tavolo / *table lamp*
cm 21 x 22 x h 21,5
1 x max 5W LED E27*

*si consiglia l'utilizzo di lampadina bianco latte
**white milk bulb is recommended*

Versioni disponibili: TAVOLO / SOSPENSIONE / PIANTANA TERRA
Available versions: TABLE LAMP / PENDANT / FLOOR LAMP

BRILLE

design matteo ugolini





TAVOLO | TABLE LAMP

Diffusore in vetro bianco satinato.
Shade in white frosted glass.



CT144 1B INT
lampada da tavolo
table lamp
cm Ø25 x h.25
1 x max 46W, E14



CT144 2B INT
lampada da tavolo
table lamp
cm Ø40 x h.38
1 x max 105W, E27

Versioni disponibili: APPLIQUE / TAVOLO /
SOSPENSIONE / PLAFONIERA
Available versions: WALL LAMP / TABLE LAMP /
PENDANT / CEILING LAMP



NORMA M

design edmondo testaguzza

*That is one of the many games
we played at that time.
The wind was always with us.
Dangling in space, hanging
Like stars we were shining
In the blue night
(to Norma M.)*





Struttura in ceramica bianca opaca,
paralume in lino bianco.
*Structure in matt white ceramic,
shade in white linen.*



C1640PBB
lampada da tavolo / *table lamp*
cm ø 22 h. 40
1 x max 60W E27

Versioni disponibili: APPLIQUE / TAVOLO / SOSPENSIONE / PIANTANA
Available versions: WALL LAMP / TABLE LAMP / PENDANT / FLOOR LAMP

TI VEDO

design matteo ugolini





Struttura in ceramica bianca opaca.
Structure in matt white ceramic.



CT105 1B INT

lampada da tavolo
table lamp
cm ø 24 h. 41
2 x max 53W E27

Versioni disponibili: APPLIQUE / TAVOLO
Available versions: WALL LAMP/ TABLE LAMP



**PIAN
TANE
TERRA**
floor lamp

ALFRED

design stefano bizzarri & claudio cinti





Struttura in metallo laccato opaco.
Structure in matt lacquered metal.



HP128 2N INT (nero/black)
HP128 1B INT (bianco/white)
piantana / floor lamp
cm h. 175 b. 35 p. 23
1 x max 52W E27

ALIBABIG

design matteo ugolini



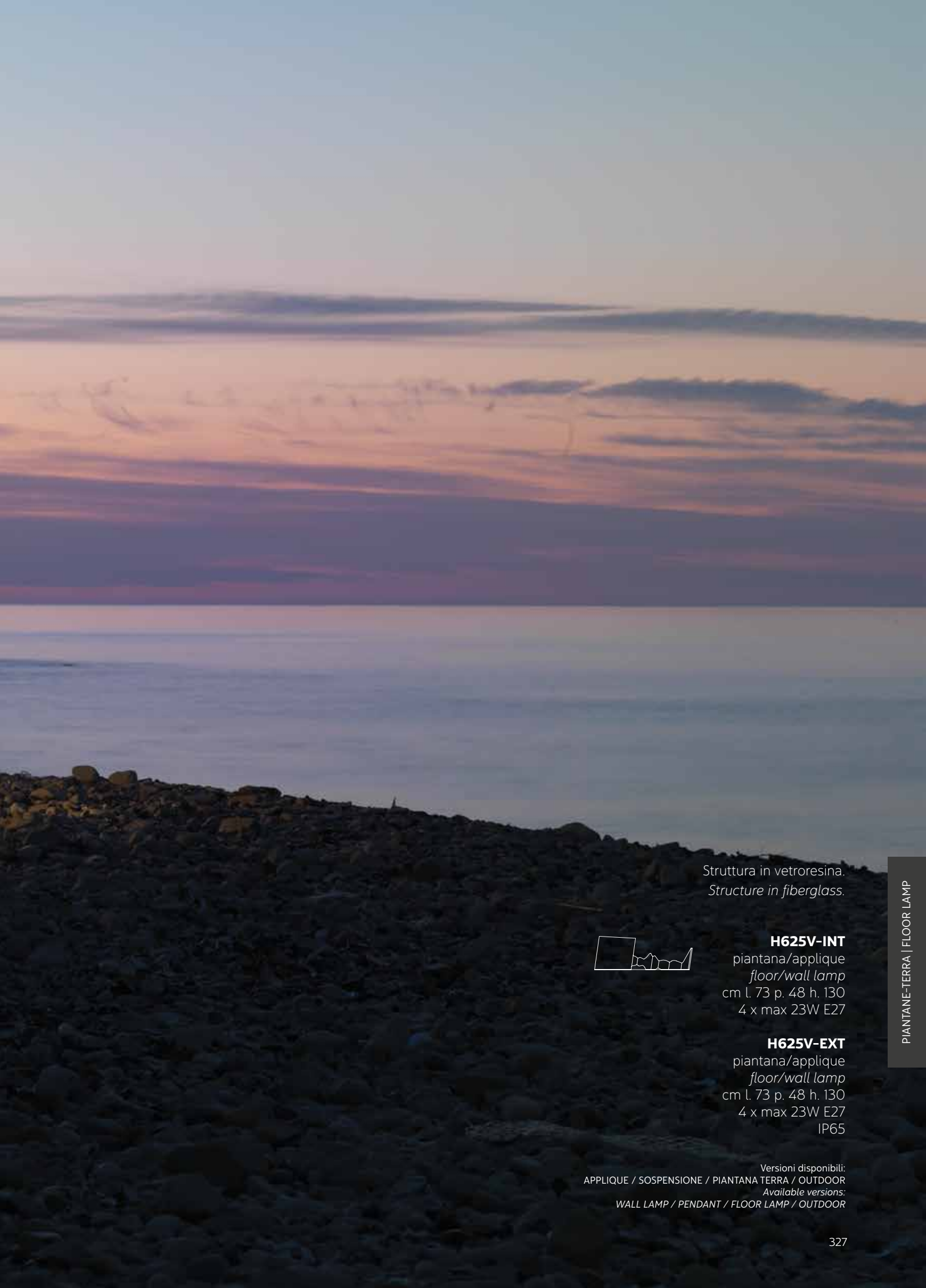

Struttura in vetroresina.
Structure in fiberglass.



H625V-INT

piantana/applique
floor/wall lamp
cm l. 73 p. 48 h. 130
4 x max 23W E27

H625V-EXT

piantana/applique
floor/wall lamp
cm l. 73 p. 48 h. 130
4 x max 23W E27
IP65

Versioni disponibili:
APPLIQUE / SOSPENSIONE / PIANTANA TERRA / OUTDOOR
Available versions:
WALL LAMP / PENDANT / FLOOR LAMP / OUTDOOR

ATELIER

design matteo ugolini



*Its lampshade looks
like a dress of haute couture,
completely handmade
tailored and decorated.*



Struttura in metallo e paralume in poliestere pennellato.
Structure in metal and shade in polyester white painted.



H6089S

piantana
floor lamp
cm ø 49 h. 183
1 x max 150W E27

Versioni disponibili: SOSPENSIONE / PIANTANA TERRA
Available versions: PENDANT / FLOOR LAMP

BAG

design baldessari e baldessari





Struttura in ceramica lucida con texture
e manico in metallo verniciato grigio
*Structure in glossy ceramic with texture
and handle in grey metal.*



HP154 BB INT (bianca/white)
HP154 BR INT (bronz/bronze)



lampada da terra / *floor lamp*
cm 32 x 35 h. 31
1 x max 15W LED E27*

Struttura in ceramica liscia lucida
e manico in metallo verniciato grigio.
*Structure in smooth glossy ceramic
and handle in grey metal.*



HP154 AB INT (bianca/white)
HP154 AR INT (bronz/bronze)



lampada da terra / *floor lamp*
cm 32 x 35 h. 31
1 x max 5W LED E27*

*si consiglia l'utilizzo di lampadina bianco latte
**white milk bulb is recommended*

Versioni disponibili: TAVOLO / SOSPENSIONE / PIANTANA TERRA
Available versions: TABLE LAMP / PENDANT / FLOOR LAMP



BLACK OUT

design matteo ugolini





Struttura in metallo verniciato bianco e paralume in filamento di vetroresina.
Structure in white painted metal and shade in fiberglass.



HP101 2B INT (bianco/white)
HP101 2T INT (trasparente/clear)
piantana / floor lamp
cm b. 60 h. 180
3 x max 52W E27



AC101 1B INT
portacandele in ceramica bianca
candle holder in white ceramic



HP101 3B INT (bianco/white)
HP101 3T INT (trasparente/clear)
lampada da terra / floor lamp
cm 70x65 ø 50
1 x max 105W E27

Versioni disponibili: SOSPENSIONE / PIANTANA TERRA / OUTDOOR
Available versions: PENDANT / FLOOR LAMP / OUTDOOR

CELL

design matteo ugolini

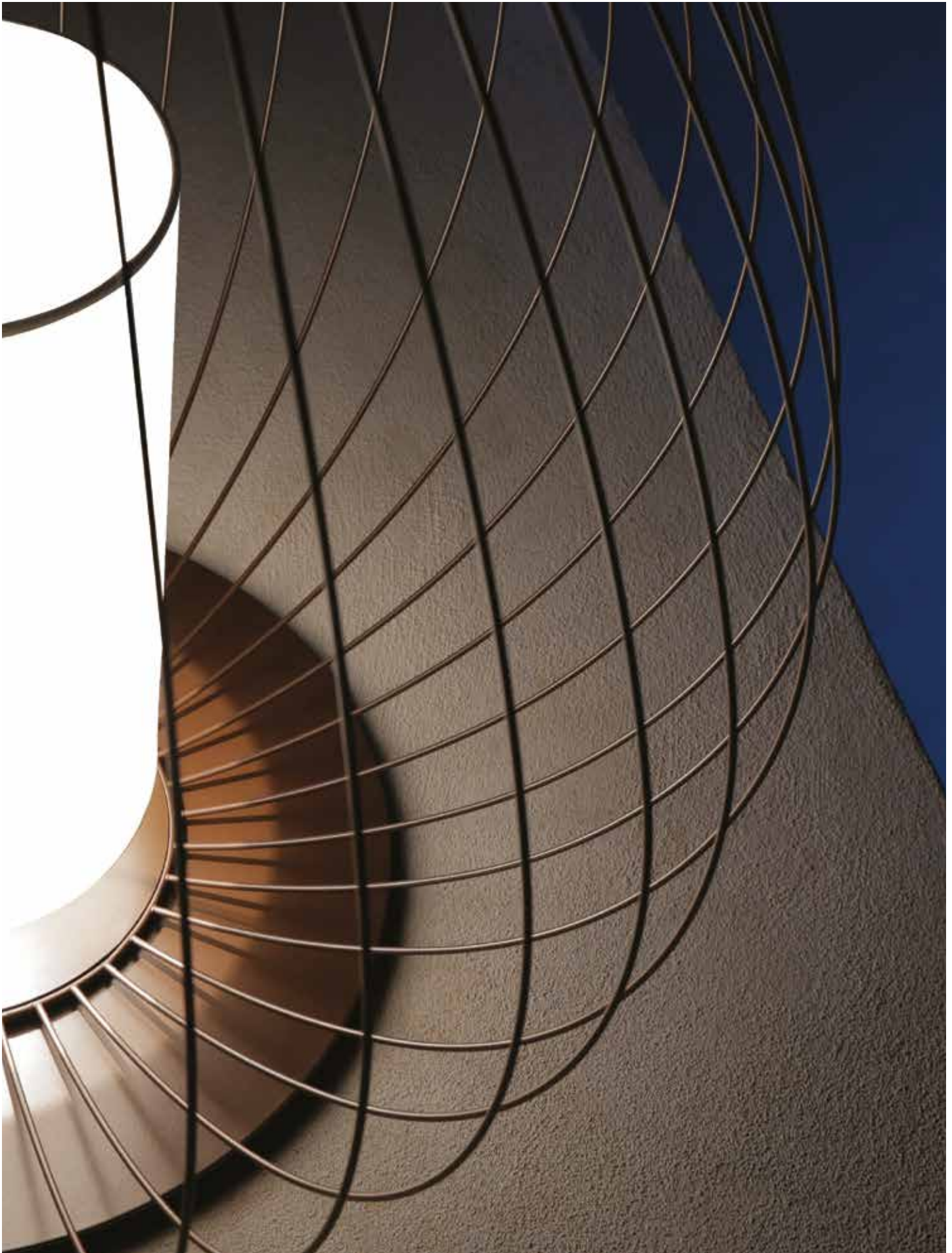

Struttura in filo metallico, paralume in lino bianco.
Structure in metallic thread, shade in white linen.



M614B (bianco/white)
CT614 CM INT (bronzo/bronze)
lampada da terra / floor lamp
cm ø 36 h. 58
1 x max 52W E27



M615B (bianco/white)
HP615 DM INT (bronzo/bronze)
lampada da terra / floor lamp
cm ø 55 h. 88
1 x max 52W E27



M612B (bianco/white)
CT612 AM INT (bronzo/bronze)
lampada da terra / floor lamp
cm ø 57 h. 62
1 x max 52W E27



M613B (bianco/white)
HP613 BM INT (bronzo/bronze)
lampada da terra / floor lamp
cm ø 84 h. 89
1 x max 70W E27

Versioni disponibili: SOSPENSIONE / PIANTANA TERRA / OUTDOOR
Available versions: PENDANT / FLOOR LAMP / OUTDOOR



CELL
design
matteo ugolini

Struttura in filo metallico,
paralume in lino bianco.
*Structure in metallic thread,
shade in white linen.*



M614B (bianco/white)
CT614 CM INT (bronzo/bronze)
lampada da terra / floor lamp
cm ø 36 h. 58
1 x max 52W E27



M615B (bianco/white)
HP615 DM INT (bronzo/bronze)
lampada da terra / floor lamp
cm ø 55 h. 88
1 x max 52W E27



M612B (bianco/white)
CT612 AM INT (bronzo/bronze)
lampada da terra / floor lamp
cm ø 57 h. 62
1 x max 52W E27



M613B (bianco/white)
HP613 BM INT (bronzo/bronze)
lampada da terra / floor lamp
cm ø 84 h. 89
1 x max 70W E27

Versioni disponibili:
SOSPENSIONE / PIANTANA TERRA / OUTDOOR
Available versions:
PENDANT / FLOOR LAMP / OUTDOOR





PIANTANE-TERRA | FLOOR LAMP

DON'T TOUCH

design matteo ugolini

*Not only give the object the
function of illuminating,
but also the power to transmit
to those who look at it an
irresistible desire to touch it.*





Struttura in tecnopolimero grigio opaco,
bacchette in PVC bianco opaco.
*Structure in matt grey techno-polymer,
sticks in matt white PVC.*



HP153 AB INT (3000K)
HP153 BB INT (2700K)
lampada da terra / floor lamp
cm Ø42 x h 108
LED module 1x29W, 2600 lm
CRI ≥ 80

Versioni disponibili: PIANTANA TERRA / OUTDOOR
Available versions: FLOOR LAMP / OUTDOOR

LIFE

design matteo ugolini

*The past can offer
a surplus value to
the present.*



Struttura in metallo color ruggine,
paralume in tessuto denim con finitura vintage.
*Structure in rust metal, shade in fabric
denim with vintage processing.*



H6051V
piantana
floor lamp
cm ø 55 h. 175
1 x max 250W E27

Versioni disponibili: APPLIQUE / SOSPENSIONE / PIANTANA TERRA
Available versions: WALL LAMP / PENDANT / FLOOR LAMP

LUCILLA

design matteo ugolini





Struttura in metallo color ruggine.
Structure in rust metal.



H6051VN
piantana
floor lamp
cm ø 55 h. 175
1 x max 250W E27

Versioni disponibili: SOSPENSIONE / PIANTANA TERRA
Available versions: PENDANT / FLOOR LAMP

NORMA M

design edmondo testaguzza



Struttura in ceramica bianca opaca,
paralume in lino bianco.
*Structure in matt white ceramic,
shade in white linen.*



H640BB

piantana bianca,
con ancoraggio a soffitto,
altezza regolabile
*white floor lamp,
with ceiling fixing,
adjustable in height*
cm ø 22 h. 40
1 x max 70W E27

Versioni disponibili: APPLIQUE / TAVOLO /
SOSPENSIONE / PIANTANA TERRA
*Available versions: WALL LAMP / TABLE LAMP /
PENDANT / FLOOR LAMP*



OTTAVO

design matteo ugolini

Struttura in tecnopolimero bianco.
Structure in white techno-polymer.



HP155 AB INT
lampada da terra
floor lamp
cm Ø23,5 x h 65,5
1 x max 5W LED GU10

HP155 AB EXT
lampada da terra
floor lamp
cm Ø23,5 x h 65,5
1 x max 5W LED GU10
IP55

Versioni disponibili: PIANTANA TERRA / OUTDOOR
Available versions: FLOOR LAMP / OUTDOOR





PIANTANE-TERRA | FLOOR LAMP

SISMA

design matteo ugolini



Struttura in tondino metallico verniciato nervato.
Structure in construction site's ribbed rebar.



HP112 1B INT (bianco/white)
HP112 1T INT (naturale/natural)
piantana / floor lamp
cm ø 63 h. 166
3 x max 77W E27

Versioni disponibili: SOSPENSIONE / PIANTANA TERRA
Available versions: PENDANT / FLOOR LAMP



TOBIA

design matteo ugolini



Struttura in tecnopolimero bianco.
Structure in white techno-polymer.



HP145 1F INT

piantana
floor lamp

cm b.31 p.8 h.165
13W LED, 1430 lumen
3000K



HP145 2P INT

piantana
floor lamp

cm b.31 p.8 h.165
13W LED, 1430 lumen
3000K



HP145 3R INT

piantana
floor lamp

cm b.46 p.12 h.165
13W LED, 1430 lumen
3000K

Versioni disponibili: PIANTANA TERRA / OUTDOOR
Available versions: FLOOR LAMP / OUTDOOR



TORCIA

design matteo ugolini



Struttura in alluminio anodizzato,
torcia in tecnopolimero grigio.
*Structure in anodized aluminum,
torch in grey techno-polymer.*



HP155 AG INT
piantana
floor lamp
cm Ø26 x h 150
1 x max 5W LED GU10



HP155 BG INT
piantana
floor lamp
cm Ø26 x h 150
2 x max 5W LED GU10

Versioni disponibili: SOSPENSIONE / PIANTANA TERRA / OUTDOOR
Available versions: PENDANT / FLOOR LAMP / OUTDOOR



PIANTANE-TERRA | FLOOR LAMP

ULULÌ E ULULÀ

design matteo ugolini

Struttura in vetroresina con inserti in pizzo.
Structure in fiberglass with lace inserts.



M648PB (ULULÌ)

lampada da terra
floor lamp
cm ø 45
1 x max 70W E27



M649GB (ULULÀ)

lampada da terra
floor lamp
cm ø 75
1 x max 105W E27

Versioni disponibili: SOSPENSIONE / PIANTANA TERRA / OUTDOOR
Available versions: PENDANT / FLOOR LAMP / OUTDOOR



PIANTANE-TERRA | FLOOR LAMP

VIA LATTEA

design stefano bizzarri & claudio cinti

*Old recollections:
the country side,
a farmer,
a stable,
a bucket of
milk...*



Struttura in cemento grigio tortora.
Structure in dove grey concrete.



HP127 1G INT
piantana / floor lamp
cm h. 37 ø 22
1 x max 15W E27



HP127 AG INT
piantana / floor lamp
cm h. 37 ø 22
1 x max 15W E27



HP127 BG INT
piantana / floor lamp
cm h. 49 ø 22
1 x max 15W E27

Versioni disponibili: PIANTANA TERRA / OUTDOOR
Available versions: FLOOR LAMP / OUTDOOR



PIANTANE-TERRA | FLOOR LAMP



**PLAFO
NIERE**

ceiling lamp

BRILLE

design matteo ugolini





Struttura in vetro bianco satinato.
Structure in white frosted glass.

PL144 1B INT

plafoniera / applique
ceiling lamp / wall lamp
cm Ø25 x h.25
1 x max 46W, E14



PL144 2B INT

plafoniera / applique
ceiling lamp / wall lamp
cm Ø40 x h.38
1 x max 105W, E27



Versioni disponibili: APPLIQUE / TAVOLO /
SOSPENSIONE / PLAFONIERA
Available versions: WALL LAMP / TABLE LAMP /
PENDANT / CEILING LAMP

EDEN COLLECTION

design matteo ugolini



Struttura in ferro con diffusore in lycra bianco.
Iron structure with shade in white synthetic fiber (lycra).



AP103 3B INT "EVA"

applique/plafoniera
wall lamp/ceiling lamp
cm h.46,5 b.30 p.16
1 x max 46W E27



AP103 2B INT "ADAMO"

applique/plafoniera
wall lamp/ceiling lamp
cm h.72 b.38 p.19
2 x max 46W E27



AP103 1B INT "EDEN"

applique/plafoniera
wall lamp/ceiling lamp
cm h.115 b.82 p.23
3 x max 46W E27

Versioni disponibili: APPLIQUE / PLAFONIERA
Available versions: WALL LAMP / CEILING LAMP



NOTREDAME

design luca de bona / dario de meo



Struttura in tecnopolimero bianco.
Structure in white techno-polymer.

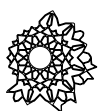

PL130 4B INT (3000K)
PL130 6B INT (2700K)
plafoniera/applique
ceiling/wall lamp
cm h. 63 b. 56 p. 11

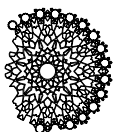

PL130 3B INT (3000K)
PL130 5B INT (2700K)
plafoniera/applique
ceiling/wall lamp
cm h. 98 b. 83 p. 11

Struttura in tecnopolimero oro.
Structure in gold techno-polymer.

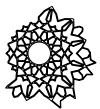

PL130 4O INT (3000K)
PL130 6O INT (2700K)
plafoniera/applique
ceiling/wall lamp
cm h. 63 b. 56 p. 11

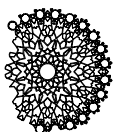

PL130 3O INT (3000K)
PL130 5O INT (2700K)
plafoniera/applique
ceiling/wall lamp
cm h. 98 b. 83 p. 11

LED frontale / *Front LED*
13W, 1520 lumen, CRI > 80
Dimmerabile / *Dimmable*
Strip LED retroilluminazione
backlight
3W, 280 lumen, CRI > 80
Dimmerabile / *Dimmable*

Versioni disponibili:
APPLIQUE / SOSPENSIONE / PLAFONIERA
Available versions:
WALL LAMP / PENDANT / CEILING LAMP





**OUT
DOOR**

ALIBABIG

design matteo ugolini





Struttura in vetroresina.
Structure in fiberglass.

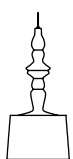

SE616V-EXT
sospensione
pendant
cm ø 50 h. 110
2 x max 23W E27
IP65

Versioni disponibili: APPLIQUE / SOSPENSIONE /
PIANTANA TERRA / INDOOR
*Available versions: WALL LAMP / PENDANT /
FLOOR LAMP / INDOOR*

OUTDOOR

ALIBABIG

design
matteo ugolini

Struttura in vetroresina.
Structure in fiberglass.



SE617V-EXT
sospensione
pendant
cm Ø 40 h. 110
2 x max 23W E27
IP65

Versioni disponibili: APPLIQUE / SOSPENSIONE /
PIANTANA TERRA / INDOOR
*Available versions: WALL LAMP / PENDANT /
FLOOR LAMP / INDOOR*

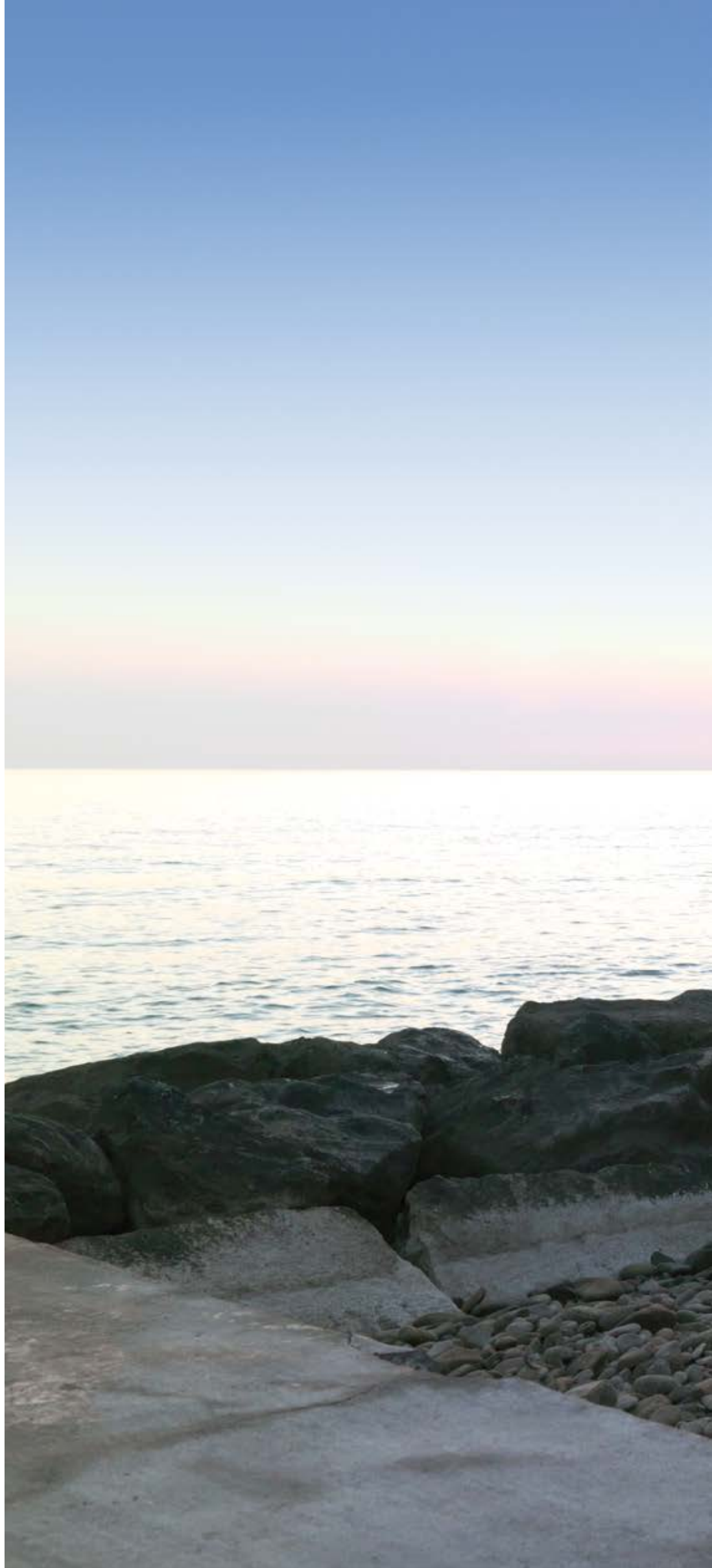



OUTDOOR

ALIBABIG

design
matteo ugolini

Struttura in vetroresina.
Structure in fiberglass

H625V-EXT

piantata/applique
floor/wall lamp
cm 73x48 h. 130
4 x max 23W E27
IP65



Versioni disponibili: APPLIQUE / SOSPENSIONE /
PIANTANA TERRA / INDOOR
Available versions: WALL LAMP / PENDANT /
FLOOR LAMP / INDOOR





BLACK OUT

design matteo ugolini





Struttura in filamento di vetroresina.
Structure in fiberglass.



SE101 1B EXT (bianco/white)
SE101 1T EXT (trasparente/clear)
sospensione / *pendant*
cm \varnothing 35 h. 40
1 x max 23W E27
IP65



SE101 2B EXT (bianco/white)
SE101 2T EXT (trasparente/clear)
sospensione / *pendant*
cm \varnothing 50 h. 60
1 x max 23W E27
IP65



HP101 3B EXT (bianco/white)
HP101 3T EXT (trasparente/clear)
lampada da terra / *floor lamp*
cm 70x65 \varnothing 50
1 x max 28W E27
IP65



HP101 2B EXT (bianco/white)
HP101 2T EXT (trasparente/clear)
piantana / *floor lamp*
cm 60x180 \varnothing 50
1 x max 23W E27
IP65

Versioni disponibili:
SOSPENSIONE / PIANTANA TERRA / INDOOR
Available versions:
PENDANT / FLOOR LAMP / INDOOR

CELL

design matteo ugolini





CELL
design
matteo ugolini





Struttura in acciaio inox, paralume in metacrilato (PMMA) bianco.
Structure in stainless steel, shade in white methacrylate (PMMA).



SE615-EXT (bianco/white)
SE615 DM EXT (bronzo/bronze)
sospensione / pendant
cm ø 55 h. 88
1 x max 23W E27
IP65



SE612-EXT (bianco/white)
SE612 AM EXT (bronzo/bronze)
sospensione / pendant
cm ø 57 h. 59
1 x max 23W E27
IP65



SE613-EXT (bianco/white)
SE613 BM EXT (bronzo/bronze)
sospensione / pendant
cm ø 84 h. 87
1 x max 23W E27
IP65

Versioni disponibili:
SOSPENSIONE / PIANTANA TERRA / INDOOR
Available versions:
PENDANT / FLOOR LAMP / INDOOR

CELL
design
matteo ugolini

Struttura in acciaio inox, paralume
in metacrilato (PMMA) bianco.
*Structure in stainless steel, shade
in white methacrylate (PMMA).*



M615-EXT (bianco/white)
HP615 DM EXT (bronzo/bronze)
lampada da terra / floor lamp
cm ø 55 h. 88
1 x max 23W E27
IP65



M612-EXT (bianco/white)
CT612 AM EXT (bronzo/bronze)
lampada da terra / floor lamp
cm ø 57 h. 62
1 x max 23W E27
IP65



M613-EXT (bianco/white)
HP613 BM EXT (bronzo/bronze)
lampada da terra / floor lamp
cm ø 84 h. 89
1 x max 23W E27
IP65

Versioni disponibili:
SOSPENSIONE / PIANTANA TERRA / INDOOR
Available versions:
PENDANT / FLOOR LAMP / INDOOR





DIES NOX

design laura alesì & silvia braconi





Struttura in vetro.
Structure in glass.



SE124 1T EXT (trasparente/clear)
SE124 2N EXT (tabacco/tobacco)
sospensione / *pendant*
cm ø 12 L. 36
11W LED, lumen 1060
3000K - dimmerabile/*dimmable*
IP44

Versioni disponibili: SOSPENSIONE / INDOOR
Available versions: PENDANT / INDOOR

DON'T TOUCH

design matteo ugolini





Struttura in tecnopolimero grigio opaco,
bacchette in PVC bianco opaco.
*Structure in matt grey techno-polymer, sticks in
matt white PVC.*



HP153 AB EXT (3000K)
HP153 BB EXT (2700K)
lampada da terra / floor lamp
Ø42 x h 108 cm
LED module 1x29W, 2600 lm
CRI ≥ 80 - IP67

Versioni disponibili: PIANTANA TERRA / INDOOR
Available versions: FLOOR LAMP / INDOOR

OUTDOOR

DON'T TOUCH

design
matteo ugolini

Struttura in tecnopolimero grigio opaco,
bacchette in PVC bianco opaco.
*Structure in matt grey techno-polymer, sticks in
matt white PVC.*



HP153 AB EXT (3000K)

HP153 BB EXT (2700K)

lampada da terra / floor lamp
Ø42 x h 108 cm

LED module 1x29W, 2600 lm
CRI ≥ 80 – IP67

Versioni disponibili: PIANTANA TERRA / INDOOR
Available versions: FLOOR LAMP / INDOOR



OUTDOOR

GINGER

design edmondo testaguzza



Struttura in vetro trasparente.
Structure in clear glass.



SE116 2A EXT
(paglierino/pale yellow)
SE116 2F EXT (fumé/smoked)
sospensione / pendant
cm ø 27 h. 26
1 x max 52W E27
IP44



SE116 1A EXT
(paglierino/pale yellow)
SE116 1F EXT (fumé/smoked)
sospensione / pendant
cm ø 30 h. 20
1 x max 52W E27
IP44



SE116 3A EXT
(paglierino/pale yellow)
SE116 3F EXT (fumé/smoked)
sospensione / pendant
cm ø 30 h. 37
1 x max 52W E27
IP44



SE116 5A EXT
(paglierino/pale yellow)
SE116 5F EXT (fumé/smoked)
sospensione / pendant
cm ø 27 h. 26
1 x max 52W E27
IP44



SE116 4A EXT
(paglierino/pale yellow)
SE116 4F EXT (fumé/smoked)
sospensione / pendant
cm ø 30 h. 20
1 x max 52W E27
IP44



SE116 6A EXT
(paglierino/pale yellow)
SE116 6F EXT (fumé/smoked)
sospensione / pendant
cm ø 30 h. 37
1 x max 52W E27
IP44

Versioni disponibili: SOSPENSIONE / INDOOR
Available versions: PENDANT / INDOOR



OUTDOOR

KIMONO

design matteo ugolini



Struttura in vetroresina bianco.
Structure in white fiberglass.



SE636V-EXT
sospensione
pendant
cm ø 40 h. 85
1 x max 23W E27
IP65

Versioni disponibili: SOSPENSIONE / INDOOR
Available versions: PENDANT / INDOOR



OUTDOOR





KIMONO

design matteo ugolini

Struttura in vetroresina bianco.
Structure in white fiberglass.



SE635V-EXT

sospensione
pendant
cm ø 50 h. 70
1 x max 23W E27
IP65

OUTDOOR

Versioni disponibili: SOSPENSIONE / INDOOR
Available versions: PENDANT / INDOOR

MOBY DICK

design matteo ugolini

Struttura in vetroresina, finitura
esterna liscia, interna naturale.
*Structure in fiberglass, smooth
outer finishing, rough inner finishing.*



SE646P-EXT

sospensione
pendant
cm 90x30 h. 30
1 x max 20W E27
IP44



SE647G-EXT

sospensione
pendant
cm 150x55 h. 55
1 x max 20W E27
IP44

Versioni disponibili:
APPLIQUE / SOSPENSIONE / INDOOR
Available versions:
WALL LAMP / PENDANT / INDOOR

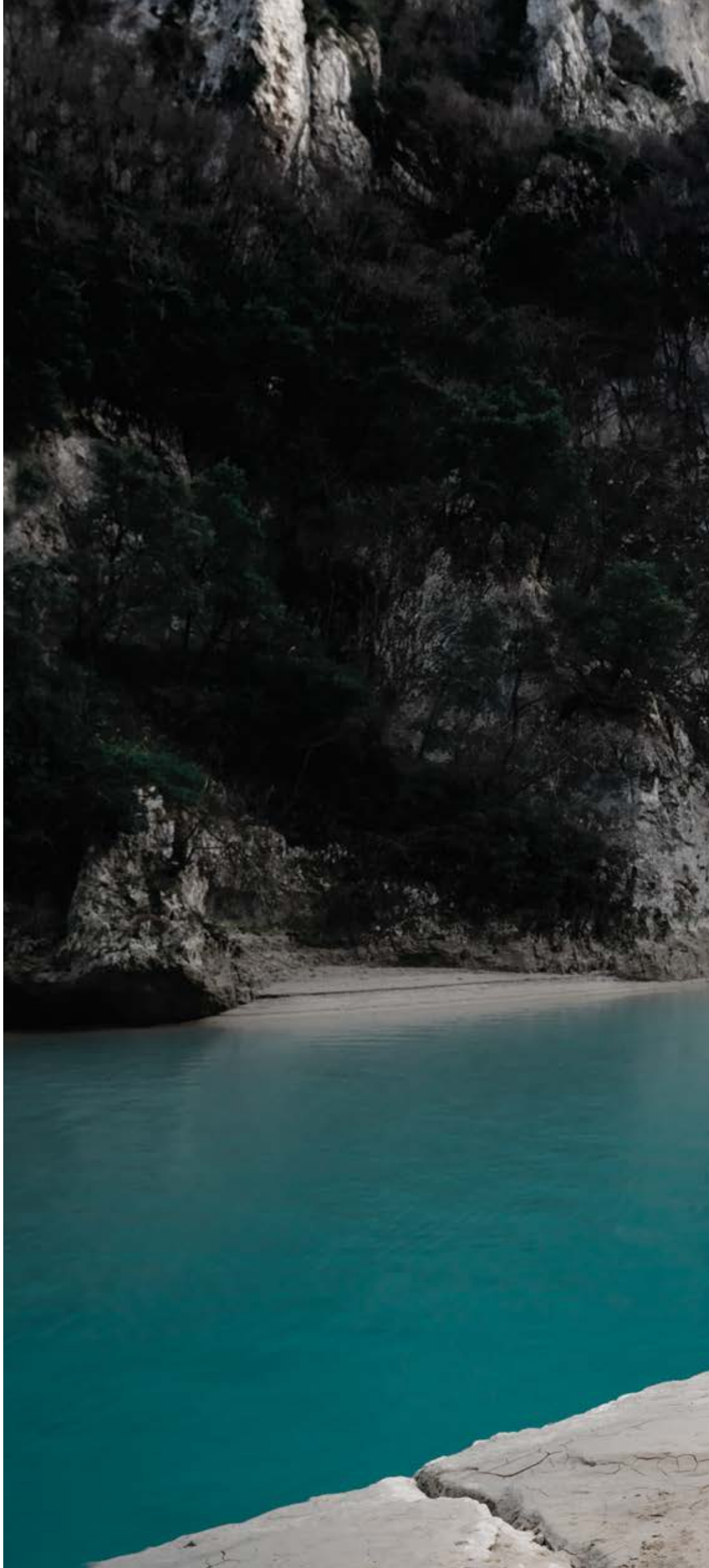



OTTAVO

design matteo ugolini



*It's the missing dwarf.
Number Eight. The one that
will bring light anywhere
you might want it...*

Struttura in tecnopolimero bianco.
Structure in white techno-polymer.



HP155 AB EXT

lampada da terra / floor lamp
cm Ø23,5 x h 65,5
1 x max 5W LED GU10 - IP55

Versioni disponibili: PIANTANA TERRA / INDOOR
Available versions: FLOOR LAMP / INDOOR



PLANCTON

design matteo ugolini





Struttura in vetroresina con bordi sfrangiati.
Structure in fiberglass with unfinished borders.



SE648/1PB-EXT

sospensione / pendant
cm ø 45 h. 25
1 x max 20W E27
IP44



SE649/1GB-EXT

sospensione / pendant
cm ø 75 h. 40
1 x max 20W E27
IP44

Versioni disponibili: SOSPENSIONE / INDOOR
Available versions: PENDANT / INDOOR

QUARANTASEI

design matteo ugolini



Struttura in cemento grigio tortora
e vetro satinato.
*Structure in dove grey concrete
and frosted glass.*

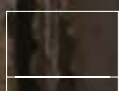

AP 140 1G EXT

applique / wall lamp
cm b.25 x h.20 x p.17
1 x max 8W LED, R7S
800 lumen - IP44

Versioni disponibili: APPLIQUE / INDOOR
Available versions: WALL LAMP / INDOOR



OUTDOOR

SETTENANI COLLECTION

design matteo ugolini



Struttura in cemento grigio tortora.
Structure in dove grey concrete.



SE686N6-EXT (PISOLO)

sospensione / *pendant*
cm ø 23 h. 20
16,6W, 1250 lumen CRI > 90
3200K
dimmerabile / dimmable
IP65



SE685N5-EXT (MAMMOLO)

sospensione / *pendant*
cm ø 24 h. 23
16,6W, 1250 lumen CRI > 90
3200K
dimmerabile / dimmable
IP65

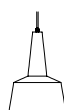

SE681N1-EXT (EOLO)

sospensione / *pendant*
cm ø 24 h. 34
16,6W, 1250 lumen CRI > 90
3200K
dimmerabile / dimmable
IP65



SE687N7-EXT (GONGOLO)

sospensione / *pendant*
cm ø 26 h. 14
16,6W, 1250 lumen CRI > 90
3200K
dimmerabile / dimmable
IP65



SE683N3-EXT (BRONTOLO)

sospensione / *pendant*
cm ø 26 h. 36
16,6W, 1250 lumen CRI > 90
3200K
dimmerabile / dimmable
IP65

Versioni disponibili: SOSPENSIONE / INDOOR
Available versions: PENDANT / INDOOR



TOBIA

design matteo ugolini



*Magically a light takes
over forgotten tools.*



OUTDOOR

TOBIA
design
matteo ugolini

Struttura in tecnopolimero bianco.
Structure in white techno-polymer.



HP145 1F EXT

piantana
floor lamp
cm b.36 x p.8 x h.165
13W LED, 1430 lumen
3000K - IP65



HP145 2P EXT

piantana
floor lamp
cm b.36 x p.8 x h.165
13W LED, 1430 lumen
3000K - IP65



HP145 3R EXT

piantana
floor lamp
cm b.46 x p.12 x h.165
13W LED, 1430 lumen
3000K - IP65

Versioni disponibili: PIANTANA TERRA / INDOOR
Available versions: FLOOR LAMP / INDOOR



TORCIA

design matteo ugolini





Struttura in alluminio anodizzato,
torcia in tecnopolimero grigio.
*Structure in anodized aluminum,
torch in grey techno-polymer.*



HP155 AG EXT
piantana / floor lamp
Ø26 x h 150 cm
1 x max 5W LED GU10
IP55



HP155 BG EXT
piantana / floor lamp
Ø26 x h 150 cm
2 x max 5W LED GU10
IP55

Versioni disponibili: SOSPENSIONE / PIANTANA TERRA / INDOOR
Available versions: PENDANT / FLOOR LAMP / INDOOR



TORCIA

design matteo ugolini

Struttura in tecnopolimero grigio.
Structure in grey techno-polymer.

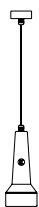

SE155 AG EXT

sospensione
pendant
Ø9 cm
1 x max 5W LED GU10
IP44



SE155 CG EXT

sospensione
pendant
Ø20 cm
3 x max 5W LED GU10
IP43

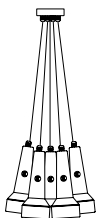

SE155 DG EXT

sospensione
pendant
Ø28 cm
7 x max 5W LED GU10
IP43

Versioni disponibili:
SOSPENSIONE / PIANTANA TERRA / INDOOR
Available versions:
PENDANT / FLOOR LAMP / INDOOR



ULULÌ ULULÀ

design matteo ugolini



Struttura in vetroresina con inserti in pizzo.
Structure in fiberglass with lace inserts.



SE648PB-EXT (ULULÌ)

sospensione / pendant

cm ø 45

1 x max 70W E27 - IP65



SE649GB-EXT (ULULÀ)

sospensione / pendant

cm ø 75

1 x max 105W E27 - IP65

Versioni disponibili: SOSPENSIONE / PIANTANA TERRA / INDOOR
Available versions: PENDANT / FLOOR LAMP / INDOOR

Struttura in vetroresina con inserti in pizzo.
Structure in fiberglass with lace inserts.



M648PB-EXT (ULULÌ)

lampada da terra / *floor lamp*
cm ø 45
1 x max 70W E27 - IP65



M649GB-EXT (ULULÀ)

lampada da terra / *floor lamp*
cm ø 75
1 x max 105W E27 - IP65

Versioni disponibili: SOSPENSIONE / PIANTANA TERRA / INDOOR
Available versions: PENDANT / FLOOR LAMP / INDOOR



VIA LATTEA

design stefano bizzarri & claudio cinti



Struttura in cemento grigio tortora.
Structure in dove grey concrete.



HP127 1G EXT
piantana / floor lamp
cm h. 37 ϕ 22
1 x max 15W E27 - IP44



AC127 3N INT
Accessorio in acciaio
Steel optional
cm h. 22 ϕ 19



HP127 AG EXT
piantana / floor lamp
cm h. 37 ϕ 22
1 x max 15W E27 - IP44



HP127 BG EXT
piantana / floor lamp
cm h. 49 ϕ 22
1 x max 15W E27 - IP44

Versioni disponibili: PIANTANA TERRA / INDOOR
Available versions: FLOOR LAMP / INDOOR



un ringraziamento particolare a tutti coloro che si sono prestati ai nostri scatti iconici:

2019

a stilarredo che con i suoi oggetti di design ha permesso di completare lo shooting del nostro fedele massimo che, questa volta ha sostituito fisicamente una vera e propria lampada. grazie ai proprietari della magnifica location di pergola, maison malatesta, che ci hanno fatto sentire a casa. e infine grazie a tutti i ritratti che hanno offerto la loro luce per realizzare questo catalogo.

2018

a lella medici che ci ha ospitato nel suo meraviglioso trullo. al gruppo "il palchettone" che ci ha aiutato nel reperire gli abiti per i nostri uomini antropomorfi. a tutti coloro, che, almeno per un attimo, desiderano guardare il mondo, "sotto un'altra luce".

2017

ad alessandra corso, che con la sua energia e la sua simpatia, è riuscita a trovare tutti e di tutto. all'architetto cosimo cardone per la sua gentilezza e disponibilità nel farci da cicerone allo splendido tabacchificio di ostuni. a landini garden, cornice perfetta per i nostri scatti evergreen. all'elegante palazzina sabatelli, che ci ha riportato in un'atmosfera seicentesca. ad alessandro micci che, come un "maestro dell'elettricità", ha saputo trovare sempre le giuste soluzioni tecniche. a tutti coloro che al momento giusto "hanno avuto bisogno di luce" e si sono prestati ai nostri folli scatti. alla puglia, regione straordinaria quanto unica.

2016

a giovanni, per gli amici pluto, che ha avuto il coraggio e la forza di cambiare. a davide detto il bimbo.... il massaggiatore dalle mani d'oro. a lucia che fa la manicure più bella che ci sia. a massimo il bello della luce che con la sua semplicità rende fantastico ogni personaggio che interpreta. alla famiglia busignani per l'originale arredamento, della loro antica e cara barberia. a container castelvecchio location che ha fatto da cornice alle nostre creazioni. a piazza duomo n°3 di urbania per gli abiti che ci hanno resi più figli!!! agli artisti morena chiodi, eva germani e pico romagnoli per le opere offerte gentilmente.

2015

alla neo-mamma diana e al piccolo ludovico.

2014

al comune e al sindaco di cartoceto per averci gentilmente ospitato nel loro suggestivo teatro. a stefano landini, proprietario del vivaio, per aver dedicato del tempo alle nostre pazzie floreali. al negozio les fleurs per aver saputo profumare i nostri scatti. all'ars urbano ducale per il nobile abito di battista sforza.

2013

al sig. ubaldo staurengi (proprietario della "filanda") per averci dato la possibilità di ambientare gli scatti del nostro catalogo 2013 in un luogo tanto unico, quanto suggestivo.

2012

al circolino del molo, vallugola (pu).



Concept: matteo ugolini / adv media lab

Photo: factory snc / oddo boni / studio leon

Layout: adv media lab

Print: arti grafiche stibu

© KARMAN 2019



Karman srl
via Grandi, 10/s
61034 Fossombrone PU - Italy
phone +39 0721 715042 r.a.
info@karmanitalia.it - www.karmanitalia.it

