















ideal lux

Light up your 2022

ideal lux.[®]

Indice

		Indice alfabetico	004
		Indice icone	008
		Introduzione azienda	030
<hr/>			
Interni		Sospensioni	048
		Lampade da soffitto	250
		Lampade da parete	332
		Lampade da tavolo	426
		Lampade da terra	468
		Sistemi	506
		Proiettori e binari	574
		Lampade da incasso	618
<hr/>			
Esterni		Sospensioni e soffitto	682
		Lampade da parete	694
		Bollard e lampade da tavolo	734
		Proiettori	772
		Incassi	786
<hr/>			
Lampadine		Lampadine e accessori	800
		Indice per codice	820

Axel

Pag 491



Abc	87	Bijoux	327	Carta	158
Acqua	755	Birds	90	Casanova	228
Admiral	323	Birds	309	Cascina	224
Agos	748	Birds	395	Ceci	796
Alfa	304	Birds	446	Cecilia	797
Alfa	387	Birds	472	Celine	273
Alfiere	452	Birillo	443	Cerchio	431
Ali	362	Bistrò	176	Chalet	240
Alien	785	Bit	788	Chalet	420
A-Line	112	Blanche	210	Chalet	460
Alma	368	Blossom	136	Channel	661
Almond	316	Blues	678	Cico	373
Amadeus	216	Boa	159	Cima	730
Amelia	760	Bob Mini	388	Cima	770
Ampolla	102	Bollicine	151	Citrus	104
Andromeda	721	Bon Bon	233	Clarissa	100
Anfora	246	Bonjour	369	Classic Globe	767
Anna	731	Book	383	Click	349
Anna	771	Boulder	454	Clio	686
Apollo	711	Bow	370	Clio	729
Arca	508	Box	345	Clio	768
Argo	719	Breeze	117	Clip	347
Aria	142	Bright	349	Cloe	183
Arizona	148	Brigitta	231	Cloud	283
Arizona	280	Brooklyn	125	Clown	150
Artù	236	Bubble	692	Cocktail	131
Audi-10	178	Bubble	728	Coco	173
Audi-20	138	Caesar	205	Colonna	500
Audi-61	178	Caesar	329	Colossal	212
Audi-77	203	Calypso	192	Cometa	732
Audi-80	179	Calypso	414	Commodore	342
Audi-B	361	Camerino	363	Compo	317
Avion	169	Canapa	242	Cono	128
Axel	448	Candy	149	Continental	215
Axel	491	Candy	281	Copernico	92
Barber	388	Candy	440	Corda	243
Base	714	Cantina	124	Corte	225
Basic	652	Cantina	400	Corte	417
Basket	167	Carlton	198	Cosmopolitan	313
Bean	378	Carlton	331	Cover	340
Bento	620	Carlton	415	Cube	348
Bergen	175	Carrara	425	Cupcake	444

Indice alfabetico

Cylinder	183	Edo	445	Flood	704	Grape	160	Keope	710
Cylinder	498	Edo Outdoor	763	Floor	793	Gretel	177	Kepler	94
Daddy	488	Ego	522	Florian	218	Groove	658	Kepler	396
Daisy	316	Ekos	187	Florian	418	Gru	432	King	193
Danieli	230	Electric	243	Fluo	542	Gun	689	King	320
Dea	310	Elica	358	Flut	133	Gun	712	Klimt	493
Deca	245	Elis	386	Fly	66	Halo	67	Konse	99
Deep	650	Elisa	765	Fly	260	Halo	266	Kool	354
Denis	362	Elisir	196	Focus	374	Hangar	118	Kraken	485
Desk	78	Elvis	479	Foglia	248	Harem	238	Krypton	784
Desk	350	Eminent	490	Foglio	343	Harem	422	Kuky	129
Diesis	113	Eos	600	Folk	141	Haunt	249	Lana	144
Diesis	477	Equinoxe	93	Forcola	502	Hilton	185	Lana	286
Disco	98	Equinoxe	399	Fox	592	Hilton	408	Lawyer	439
Display	604	Eris	120	Frame	64	Hilton	451	Le Roy	466
Dna	164	Essence	76	Frame	256	Hilton	501	Leaves	96
Doc	106	Essence	364	Francy	723	Holiday	412	Led Panel	664
Doge	229	Etere	707	Frida	106	Holly	114	Lena	145
Dolomiti	454	Etere	762	Frida	393	Hotel	411	Leo	790
Dony	287	Eternity	453	Funky	676	Hub	747	Leti	791
Doris	742	Etna	140	Futura	434	Hugo	107	Level	278
Dorothy	503	Eva	138	Futura	481	Hulahoop	62	Liberty	224
Dorsale	486	Evasione	203	Game	634	Ice	103	Lido	171
Double	373	Eye	672	Gas	702	Igor	89	Lika	289
Down	733	Fade	137	Gas	754	Igor	394	Lika	666
Dream Big	168	Febe	733	Gea	413	Iguazù	127	Line	367
Driftwood	241	Fiesta	693	Geko	277	Iko	715	Lingotto	88
Driftwood	458	Filo	74	Gemini	56	Impero	223	Lingotto	314
Driftwood	492	Fiocco	423	Gemma	288	Indio	790	Lingotto	447
Dubai	204	Fiordi	122	Giada	195	Inside	781	Link	612
Dubai	329	Firenze	234	Gim	385	Io	375	Linus	79
Dubai	415	Firenze	420	Gingle	276	Itaca	746	Linus	351
Duchessa	465	Firenze	461	Gioconda	222	Jar	741	Lite	381
Dust	97	Firenze	505	Gioconda	419	Jazz	676	Live	740
Dynamic	626	Fish	82	Giove	722	Justine	235	Livia	689
Dynamite	84	Fisherman	119	Giudecca	217	Kali	455	Logos	275
Dynamite	296	Fix	343	Glim	302	Karma	140	Loko	160
Dynamo	377	Flam	126	Glim	603	Karol	258	Lolita	738
Echo	352	Flash	355	Glory	147	Karousel	80	London	182
Eclissi	405	Flash Gesso	355	Glory	278	Kate	464	London	449
Edison	107	Flat	272	Gocce	127	Kelly	436	London	495
Edison	391	Flex	377	Goose	376	Ken	172	Look	70

Indice alfabetico

Look	290	Minimal	392	Nova	662	Pashà	319	Read	382
Look	357	Minimal	476	Oak	72	Pashà	414	Regol	494
Look	603	Minitommy	700	Oak	294	Path	753	Relax	274
Lord	136	Minitommy	778	Oby	301	Paul	358	Retrò	372
Lounge	676	Minor	68	Oby	386	Pauline	96	Rex-1	724
Luce Max	152	Mint	174	Ocean	273	Pauline	310	Rex-2	725
Lucia	726	Miramare	232	Octopus	311	Pegaso	208	Rex-3	725
Lugano	105	Mirror-10	371	Off	646	Pegaso	417	Rhapsody	81
Luna	685	Mirror-20	373	Office	556	Pegaso	467	Rialto	227
Luna	744	Moby	121	Oil	110	Pegaso	504	Riflesso	367
Luxor	202	Monet	207	Olimpia	132	Peggy	341	Ring	288
Luxury	410	Mood	293	Omega Round	698	Perlage	91	Ritz	285
Luxury	450	Moonlight	325	Omega Square	699	Perlage	397	Rocket	799
Luxury	499	Moris	344	One	642	Peter	421	Rocket Mini	798
Madame	180	Mouse	300	Onion	101	Petit	298	Roma	199
Maddi	727	Mouse	384	Opera	190	Phoenix	181	Roma	318
Magnolia	328	Mouse	602	Opera	416	Pipe	380	Roma	414
Mama	142	Mr Jack	109	Opera	463	Play	297	Roma	462
Manhattan	132	Multiflex	169	Opera	503	Play	660	Rondo	247
Mapa Bianco	156	Multiflex	311	Oracle	63	Plissé	143	Room-33	640
Mapa Bianco	280	Nabucco	200	Oracle Slim	60	Plumber	308	Room-65	677
Mapa Bianco	360	Napoleon	220	Oracle Slim	254	Polka	680	Rose	213
Mapa Bianco	441	Navy	118	Orangerie	247	Polly	480	Royal	326
Mapa Fade	154	Nawa	239	Origami	134	Pop	83	Rubik	717
Mapa Max	153	Negresco	214	Orion	192	Posta	346	Rudy	301
Mapa Max	442	Negresco	418	Orion	321	Pouche	341	Rudy	385
Mapa Plus	151	Nemo	162	Ovalino	166	Prato	444	Sailor	123
Mapa Riga	159	Nemo Plus	161	Ovalino	282	Privè	366	Sally	437
Mapa Sat	153	Neve	324	Ovalino	358	Probe	382	Sally	483
Maracas	305	Newton	400	Oz	58	Provence	211	Samba	674
Maracas	398	Newton	478	Oz	259	Provence	505	Santa	423
Marte	766	Nitro	292	Oz	339	Pulsar	761	Sasso	745
Martinez	197	Nodi	165	Oz	430	Puzzle	345	Scacchi	424
Martinez	330	Nodi	306	Page	379	Quadro	322	Sem	225
Mercurio	766	Nodi	396	Pagoda	489	Quark	645	Set Up	188
Metro	117	Nodi Crystal	307	Pan	85	Queen	466	Set Up	406
Mib	692	Nodino	307	Pan	402	Queen	504	Set Up	456
Microphone	446	Nordik	182	Pantheon	211	Quick	576	Set Up	496
Microphone	476	Nordik	410	Paris	467	Radio	390	Shell	287
Milk	130	Nordik	450	Park	794	Rain	194	Sheraton	412
Millennium	206	Nordik	498	Park Led	795	Rain	330	Shower	401
Minimal	108	Norma	244	Pashà	201	Rain	462	Simply	286

Sirio	750	Swing	676	Universal R.	268
Sky	73	Syntesi	338	Universal S.	270
Sky	291	Tall	112	Up	716
Sky	356	Taurus	792	Up And Down	125
Slem	304	Techo	688	Urano	691
Slem	387	Terra	702	Vanity	237
Slot	566	Terra	780	Vega	757
Smarties	146	Tesi	558	Vela	342
Smarties	279	Tesla	752	Venus	761
Smarties	360	Tetris-1	718	Versus	69
Smarties	440	Tetris-2	719	Virgin	321
Smile	584	Thor	774	Virtus	348
Snake	386	Tick	404	Virus	644
Snell	459	Tiepolo	216	Vision	560
Snif Round	708	Tifone	756	V-Line	77
Snif Square	709	Titano	751	Vortex	97
Soda	359	Toby	297	Walky	681
Soft	170	Tokyo	167	Wally	437
Sole	684	Tolomeo	139	Wally	482
Sole	743	Tommy	701	Way	799
Soul	679	Tommy	779	Wheel	186
Spark	95	Tonic	359	Wheel	285
Spark	312	Torre	764	Winery	299
Spike	295	Totem	275	Winery	389
Spot	300	Tower	295	Wire	789
Spot	384	Triade	115	Woody	184
Spot	602	Triplo	361	Woody	284
Stage	484	Tristan	130	Woody	409
Stand Up	475	Triumph	86	World	99
Stardust	739	Triumph	308	Xeno	690
Starlight	776	Triumph	398	Xeno	703
Steel	552	Tronco	706	Yoko	77
Stella	245	Tronco	758	Yoko	433
Stones	424	Truman	438	Yoko	474
Strauss	226	Tube	72	York	493
Strauss	419	Tudor	363	Yurta	116
Style	705	Twin	720	Zenith	754
Style	749	Ulex	782	Zenith	781
Sunglasses	690	Ulisse	148	Zeno	172
Sunrise	403	Ultrathin	75	Zephyr	673
Swan	191	Umile	135	Zig Zag	353
Swan	416	Union	272		



Syntesi

Pag 338





















































Perlage

Pag 091

























































Indice icone

Interni
Sospensioni

		<small>new</small> 				
Gemini 056	Oz 058	OracleSlim 060	Hula hoop 062	Oracle 063	Frame 064	Fly 066
						
Halo 067	Minor 068	Versus 069	Look 070	Tube 072	Oak 072	Sky 073
<small>new</small> 		<small>new</small> 		<small>new</small> 		
Filo 074	Ultrathin 075	Essence 076	Yoko 077	V-Line 077	Desk 078	Linus 079
						
Karousel 080	Rhapsody 081	Fish 082	Pop 083	Dynamite 084	Pan 085	Triumph 086
			<small>new</small> 	<small>new</small> 		
Abc 087	Lingotto 088	Igor 089	Birds 090	Perlage 091	Copernico 092	Equinoxe 093
						
Kepler 094	Spark 095	Leaves 096	Pauline 096	Vortex 097	Dust 097	Disco 098
						
Konse 099	World 099	Clarissa 100	Onion 101	Ampolla 102	Ice 103	Citrus 104

Interni

Sospensioni

						
Lugano 105	Frida 106	Doc 106	Edison 107	Hugo 107	Minimal 108	Mr Jack 109
		new 				
Holly 114	Triade 115	Yurta 114	Metro 117	Breeze 117	Hangar 118	Navy 118
						
Sailor 123	Cantina 124	Brooklyn 125	UpandDown 125	Flam 126	Iguazù 127	Gocce 127
						
Cocktail 131	Olimpia 132	Manhattan 132	Flut 133	Origami 134	Umile 135	Blossom 136
						new 
Tolomeo 139	Karma 140	Etna 140	Folk 141	Aria 142	Mama 142	Plissé 143
						
Ulisse 148	Arizona 148	Candy 149	Clown 150	Bollicine 151	Mapa Plus 151	Luce Max 152
new 						
Carta 158	Boa 159	Mapa Riga 159	Grape 160	Loko 160	Nemo Plus 161	Nemo 162
						
Tokyo 167	Dream Big 168	Avion 169	Multiflex 169	Soft 170	Lido 171	Ken 172



Oil 110



Tall 112



A-Line 112

new



Diesis 113



Fisherman 119



Eris 120



Moby 121



Fiordi 122



Cono 128



Kuky 129



Milk 130



Tristan 130



Lord 136

new



Fade 137



Audi-20 138



Eva 138



Lana 144



Lena 145



Smarties 146



Glory 147



Mapa Sat 153



Mapa Max 153



Mapa Fade 154



MapaBianco 156



Dna 164



Nodi 165



Ovalino 166



Basket 167



Zeno 172

new



Coco 173



Mint 174































Bergen 175



Fade

Pag 137



			
Bistrò 176	Gretel 177	Audi-61 178	Audi-10 178
			
Woody 184	Hilton 185	Wheel 186	Ekos 187
			
Giada 195	Elisir 196	Martinez 197	Carlton 198
			
Caesar 205	Millennium 206	Monet 207	Pegaso 208
			
Tiepolo 216	Amadeus 216	Giudecca 217	Florian 218
			
Strauss 226	Rialto 227	Casanova 228	Doge 229
			
Vanity 237	Harem 238	Nawa 239	Chalet 240

Interni

Sospensioni



Audi-80 179



Madame 180



Phoenix 181



London 182



Nordik 182



Cylinder 183



Cloe 183



Set Up 188



Opera 190



Swan 191



Calypso 192



Orion 192



King 193



Rain 194



Roma 199



Nabucco 200



Pashà 201



Luxor 202



Evasione 203



Audi-77 203



Dubai 204



Blanche 210



Pantheon 211



Provence 211



Colossal 212



Rose 213



Negresco 214



Continental 215



Napoleon 220



Gioconda 222



Impero 223



Liberty 224



Cascina 224



Corte 225



Sem 225



Danieli 230



Brigitta 231



Miramare 232



Bon Bon 233



Firenze 234



Justine 235



Artù 236



Driftwood 241



Canapa 242



Electric 243



Corda 243



Norma 244



Stella 245



Deca 245



Anfora 246



Orangerie 247



Rondo 247



Foglia 248



Haunt 249

Interni

Lampade da soffitto



Oracle Slim 254 Frame 256 Karol 258 Oz 259 Fly 260 Halo 266 Universal R. 268



Ocean 273 Relax 274 Totem 275 Logos 275 Gingle 276 Geko 277 Glory 278



Candy 281 Ovalino 282 Cloud 283 Woody 284 Wheel 285 Ritz 285 Simply 286



Ring 288 Lika 289 Look 290 Sky 291 Nitro 292 Mood 293 Oak 294



Toby 297 Petit 298 Winery 299 Mouse 300 Spot 300 Rudy 301 Oby 301



Nodi 306 Nodino 307 NodiCrystal 307 Triumph 308 Plumber 308 Birds 309 Dea 310



Cosmopolitan 313 Lingotto 314 Almond 316 Daisy 316 Compo 317 Roma 318 Pashà 319





























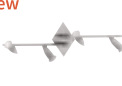



Admiral 323 Neve 324 Moonlight 325 Royal 326 Bijoux 327 Magnolia 328 Dubai 329

























Oracle Slim

Pag 254



























































			
Universal S. 270	Union 272	Flat 272	Celine 273
			
Level 278	Smarties 279	Arizona 280	MapaBianco 280
			
Lana 286	Dony 287	Shell 287	Gemma 288
			
Tower 295	Spike 295	Dynamite 296	Play 297
			
Glim 302	Alfa 304	Slem 304	Maracas 305
			
Pauline 310	Multiflex 311	Octopus 311	Spark 312
			
King 320	Virgin 321	Orion 321	Quadro 322
			
Caesar 329	Rain 330	Martinez 330	Carlton 331



<small>new</small>			
Syntesi 338	Oz 339	Cover 340	
		<small>new</small>	
Puzzle 345	Box 345	Posta 346	
<small>new</small>	<small>new</small>		
		Kool 354	
Echo 352	Zig Zag 353		
			
Soda 359	Tonic 359	Smarties 360	
<small>new</small>			
Essence 364	Privè 366	Line 367	
			
Cico 373	Double 373	Focus 374	
			
Lite 381	Probe 382	Read 382	
	<small>new</small>	<small>new</small>	
Elis 386	Alfa 387	Slem 387	

Interni

Lampade da parete

						
Peggy 341	Pouche 341	Vela 342	Commodore 342	Fix 343	Foglio 343	Moris 344
						
Clip 347	Cube 348	Virtus 348	Click 349	Bright 349	Desk 350	Linus 351
						
Flash 355	FlashGesso 355	Sky 356	Look 357	Paul 358	Elica 358	Ovalino 358
						
MapaBianco 360	Triplo 361	Audi-B 361	Ali 362	Denis 362	Tudor 363	Camerino 363
						
Riflesso 367	Alma 368	Bonjour 369	Bow 370	Mirror-10 371	Retrò 372	Mirror-20 373
new 						new 
IO 375	Goose 376	Flex 377	Dynamo 377	Bean 378	Page 379	Pipe 380
						
Book 383	Mouse 384	Spot 384	Gim 385	Rudy 385	Oby 386	Snake 386
						
Barber 388	Bob Mini 388	Winery 389	Radio 390	Edison 391	Minimal 392	Frida 393

Interni

Lampade da parete



Igor 394

new



Birds 395



Nodi 396



Kepler 396

new



Perlage 397



Triumph 398

new



Maracas 398



Newton 400



Shower 401



Pan 402



Sunrise 403



Tick 404



Eclissi 405



Set Up 406



Luxury 410



Nordik 410



Hotel 411



Holiday 412



Sheraton 412



Gea 413



Calypso 414



Carlton 415



Dubai 415



Opera 416



Swan 416



Corte 417



Pegaso 417



Negresco 418



Strauss 419



Firenze 420



Chalet 420



Peter 421



Harem 422



Santa 423



Fiocco 423



Carrara 425



Equinoxe 399



Cantina 400



Hilton 408



Woody 409



Roma 414



Pashà 414



Florian 418



Gioconda 418



Stones 424



Scacchi 425



Perlage

Pag 397













































Axel

Pag 448



Interni

Lampade da tavolo

				 new		 new
Oz 430	Cerchio 431	Gru 432	Yoko 433	Futura 434	Kelly 436	Sally 437
 new						
Wally 437	Truman 438	Lawyer 439	Smarties 440	Candy 440	MapaBianco 441	MapaMax 442
					 new	
Birillo 443	Prato 444	Cupcake 444	Edo 445	Microphone 446	Birds 446	Lingotto 447
 new						
Axel 448	London 449	Luxury 450	Nordik 450	Hilton 451	Alfiere 452	Eternity 453
						
Dolomiti 454	Boulder 454	Kali 455	Set Up 456	Driftwood 458	Snell 459	Chalet 460
						
Firenze 461	Roma 462	Rain 462	Opera 463	Kate 464	Duchessa 465	Queen 466
						
				Le Roy 466	Paris 467	Pegaso 467

Interni

Lampade da terra

new



Birds 472



Yoko 474



Stand Up 475



Minimal 476



Microphone 476

new



Diesis 477



Newton 478

new



Wally 482

new



Sally 483



Stage 484



Kraken 485



Dorsale 486



Daddy 488

new



Axel 491



Driftwood 492



York 493



Klimt 493



Regol 494



London 495



Set Up 496



Colonna 500



Hilton 501



Forcola 502



Dorothy 503



Opera 503



Queen 504



Pegaso 504

Birds

Pag 472



Elvis 479



Polly 480

new



Futura 481



Pagoda 489



Eminent 490



Cylinder 498



Nordik 498



Luxury 499



Provence 505



Firenze 505



One

Pag 642

Sistemi

new



Arca 508

new



Ego 522



Fluo 542



Steel 552



Office 556



Tesi 558



Vision 560



Slot Recessed 568



Slot Surface 570



Slot Angular 572

Proiettori e binari



Quick 576



Smile 584

new



Fox 592

new



Eos 600

new



Mouse 602

new



Spot 602



Glim 603



Look 603

new



Display 604



Link 612

Interni

Lampade da incasso

new



Bento 620



Dynamic 626

new



Game 634



Room-33 640

new



One 642



Virus 644



Quark 645



Off 646



Deep 650



Basic 652



Groove 658



Play 660



Channel 661



Nova 662



Led Panel 664



Lika 666



Eye 672



Zephyr 673



Samba 674



Jazz 676



Swing 676



Lounge 676



Funky 676



Room-65 677



Blues 678



Soul 679



Soul 679



Polka 680



Walky 681

Sospensioni e soffitto



Sole 684



Luna 685



Clio 686



Clio 686



Clio 686



Clio 686



Clio 686



Clio 686



Techo 688



Gun 689



Livia 689



Sunglasses 690



Xeno 690



Urano 691



Bubble 692











































Mib 692



Fiesta 693





Esterni

Lampade da parete

<small>new</small>	<small>new</small>					
						
Omega R. 698	Omega S. 699	Minitommy 700	Tommy 701	Terra 702	Gas 702	Xeno 703
						
Flood 704	Style 705	Tronco 706	Etere 707	Snif R. 708	Snif S. 709	Keope 710
						
Apollo 711	Gun 712	Base 714	Iko 715	Up 716	Rubik 717	Tetris-1 718
						
Tetris-2 719	Argo 719	Twin 720	Andromeda 721	Giove 722	Francy 723	Rex-1 724
						
Rex-2 725	Rex-3 725	Lucia 726	Maddi 727	Bubble 728	Clio 729	Clio 729
						
Clio 729	Cima 730	Anna 731	Cometa 732	Down 733	Febe 733	

Esterni

Bollard e lampade da tavolo

						
Lolita 738	Stardust 739	Live 740	Live 740	Live 740	Jar 741	Doris 742
						
Sole 743	Luna 744	Sasso 745	Itaca 746	Hub 747	Agos 748	Style 749
						
Sirio 750	Titano 751	Tesla 752	Path 753	Gas 754	Zenith 754	Acqua 755
						
Tifone 756	Vega 757	Tronco 758	Amelia 760	Pulsar 761	Venus 761	Etere 762
						
Edo Outdoor 763	Torre 764	Elisa 765	Marte 766	Mercurio 766	Classic Globe 767	Clio 768
						
Clio 768	Clio 768	Cima 770	Anna 771			

Proiettori



Thor 774



Starlight 776



Minitommy 778



Tommy 779



Terra 780



Inside 781



Zenith 781



Ulex 782



Krypton 784



Alien 785

Incassi



Bit 788



Wire 789



Indio 790



Leo 790



Leti 791



Taurus 792



Floor 793



Park 794



Park Led 795



Ceci 796



Cecilia 797



RocketMini 798



Rocket 799



Way 799



Lolita

Pag 738

“C'è un gesto quotidiano
che ognuno di noi compie
al sopraggiungere del buio.
Un rito familiare che
rappresenta gioia, sicurezza,
momento dedicato allo
stare insieme.

**Accendere una luce è
un'azione semplice,
ma carica di significati.
Da qui inizia la nostra storia.”**



ideal lux



Light up your moments

Ideal lux **si impegna ogni giorno per diventare** il punto di riferimento nella scelta di una lampada che esprima la propria personalità attraverso un complemento d'arredo unico e attuale.

Tutto nasce nel 1974, dall'intuizione di ideare complementi d'arredo illuminotecnici attuali e accessibili. Da allora, ideal lux si impegna ad ascoltare le necessità di tutti, proponendo un'ampissima varietà di stili di illuminazione e **venendo incontro** a ogni esigenza funzionale. Che sia una famiglia, un'attività commerciale o una persona all'inizio

della sua avventura in una nuova casa, ideal lux promette **componenti all'altezza di esigenze e sogni.**

Il punto di forza, irrinunciabile quando si parla di vicinanza tra azienda e persone, è un catalogo che va incontro a qualunque tipo di esigenza: **più di 3.000 complementi d'arredo** che spaziano tra tantissime linee prodotte, dai complementi da interno ed esterno, fino ad arrivare a quelli più tecnici.



Giving shape to light

Quando si parla di soluzioni da interno, l'obiettivo di ideal lux è quello di **creare scenografie** versatili per tutti gli ambienti, lasciando **vivere ogni momento** con la giusta atmosfera e offrendo a tutti la possibilità di **sperimentare con la propria idea di casa**. Anche fuori, le soluzioni proposte per gli spazi esterni non rinunciano a estetica e sicurezza, restando un piacevole **elemento di design** anche nei momenti in cui si ha bisogno di un po' d'aria.

Per gli spazi professionali, che richiedono **un'attenzione tecnica particolare**, ideal lux ha pensato di lavorare su tantissime proposte che aiutano a distribuire la luce nella giusta direzione dando maggiore

resa ai colori, senza mai perdere di vista il design e **rendendo unici** anche gli spazi in cui si creano relazioni professionali.

Ma se da una parte garantire la scelta e proporre un catalogo vasto costituisce un obiettivo commerciale molto importante, dall'altra, anche **la relazione con i clienti** è un aspetto che ideal lux coltiva con meticolosa cura. Come lo fa? Assicurando la possibilità di acquistare un prodotto di design, aggiornato alle tendenze più attuali e, soprattutto, accessibile a tutti. Che lo stile preferito sia industrial, minimal, classico, contemporaneo, moderno o eclettico... chiunque lo desideri può **entrare nel mondo ideal lux**.













Per ideal lux una lampada è molto più di un oggetto. L'illuminazione ha il potere di **influenzare la quotidianità**, donando **carattere e personalità uniche agli ambienti**. Per questo, ogni giorno ideal lux si impegna ad ascoltare le persone e le loro storie, con l'obiettivo di coltivare un **rapporto autentico e spontaneo**, e trovando nel racconto nuovi punti di vista, nuove ispirazioni. Il **Customer Care** costituisce un ramo importante dell'azienda, distinguendosi per la cura e per l'attenzione che dedica ai clienti e facendo dell'affidabilità uno dei principi più importanti.

L'attenzione per le persone è centrale. Con ideal lux la luce diventa quell'elemento della quotidianità capace di **trasformare l'ordinario in straordinario**. Perché accada, è importante scegliere l'illuminazione adatta alle proprie esigenze, perché con la luce giusta ogni ambiente può assumere **tutta un'altra forma, un'altra storia**.

The ordinary is extraordinary

Un brand, tante persone.

Crederci nelle persone è una scelta che facciamo ogni giorno. Valorizziamo i dipendenti, crescendo giorno dopo giorno assieme a loro, e costruiamo relazioni durature e trasparenti con clienti e fornitori.

Il design alla portata di tutti.

Vogliamo far entrare il design nella quotidianità delle persone, con soluzioni luminose esteticamente belle e funzionali, ma a costi contenuti.

Saper ascoltare.

Ci impegniamo a comprendere le necessità e i sogni dei clienti e a trasformare le difficoltà in occasioni, con l'obiettivo di migliorare costantemente in questa direzione.

Non c'è qualità senza garanzia.

Abbiamo esteso la garanzia di tutti i nostri complementi illuminotecnici a 5 anni, per assicurare in ogni momento una qualità elevata di prodotto e servizio.

Un brand,
tante persone.

Saper
ascoltare.

Non c'è
qualità senza
garanzia.

Il design
alla portata
di tutti.

Cliente



Your projects,

Projects — Restaurant & Bar

Murcia, Spain

Restaurant
Yakk and Grill

Products:
Winery
Triumph





our products.

Projects — Working spaces

Cremona, Italy

Company
Nicro S.p.A.

Products:
Nova



Projects — Restaurant & Bar

Backery
Strobino

Novara, Italy

Products:
Look
Nova



Projects — Home spaces

Private house

Spain

Products:
Equinoxe





Interni

Sospensioni

Indice alfabetico

Abc	87	Carlton	198	Edison	107
A-Line	112	Carta	158	Ekos	187
Amadeus	216	Casanova	228	Electric	243
Ampolla	102	Cascina	224	Elisir	196
Anfora	246	Chalet	240	Equinoxe	93
Aria	142	Citrus	104	Eris	120
Arizona	148	Clarissa	100	Essence	76
Artù	236	Cloe	183	Etna	140
Audi-10	178	Clown	150	Eva	138
Audi-20	138	Cocktail	131	Evasione	203
Audi-61	178	Coco	173	Fade	137
Audi-77	203	Colossal	212	Filo	74
Audi-80	179	Cono	128	Fiordi	122
Avion	169	Continental	215	Firenze	234
Basket	167	Copernico	92	Fish	82
Bergen	175	Corde	243	Fisherman	119
Birds	90	Corte	225	Flam	126
Bistrò	176	Cylinder	183	Florian	218
Blanche	210	Danieli	230	Flut	133
Blossom	136	Deca	245	Fly	66
Boa	159	Desk	78	Foglia	248
Bollicine	151	Diesis	113	Folk	141
Bon Bon	233	Disco	98	Frame	64
Breeze	117	Dna	164	Frida	106
Brigitta	231	Doc	106	Gemini	56
Brooklyn	125	Doge	229	Giada	195
Caesar	205	Dream Big	168	Gioconda	222
Calypso	192	Driftwood	241	Giudecca	217
Canapa	242	Dubai	204	Glory	147
Candy	149	Dust	97	Gocce	127
Cantina	124	Dynamite	84	Grape	160







Indice alfabetico

Gretel	177	Mapa Sat	153	Pop	83
Halo	67	Martinez	197	Provence	211
Hangar	118	Metro	117	Rain	194
Harem	238	Milk	130	Rhapsody	81
Haunt	249	Millennium	206	Rialto	227
Hilton	185	Minimal	108	Roma	199
Holly	114	Minor	68	Rondo	247
Hugo	107	Mint	174	Rose	213
Hula hoop	62	Miramare	232	Sailor	123
Ice	103	Moby	121	Sem	225
Igor	89	Monet	207	Set Up	188
Iguazù	127	Mr Jack	109	Sky	73
Impero	223	Multiflex	169	Smarties	146
Justine	235	Nabucco	200	Soft	170
Karma	140	Napoleon	220	Spark	95
Karousel	80	Navy	118	Stella	245
Ken	172	Nawa	239	Strauss	226
Kepler	94	Negresco	214	Swan	191
King	193	Nemo	162	Tall	112
Konse	99	Nemo Plus	161	Tiepolo	216
Kuky	129	Nodi	165	Tokyo	167
Lana	144	Nordik	182	Tolomeo	139
Leaves	96	Norma	244	Triade	115
Lena	145	Oak	72	Tristan	130
Liberty	224	Oil	110	Triumph	86
Lido	171	Olimpia	132	Tube	72
Lingotto	88	Onion	101	Ulisse	148
Linus	79	Opera	190	Ultrathin	75
Loko	160	Oracle	63	Umile	135
London	182	Oracle Slim	60	Up And Down	125
Look	70	Orangerie	247	Vanity	237
Lord	136	Origami	134	Versus	69
Luce Max	152	Orion	192	V-Line	77
Lugano	105	Ovalino	166	Vortex	97
Luxor	202	Oz	58	Wheel	186
Madame	180	Pan	85	Woody	184
Mama	142	Pantheon	211	World	99
Manhattan	132	Pashà	201	Yoko	77
Mapa Bianco	156	Pauline	96	Yurta	116
Mapa Fade	154	Pegaso	208	Zeno	172
Mapa Max	153	Perlage	91		
Mapa Plus	151	Phoenix	181		
Mapa Riga	159	Plissé	143		

























































Interni

Indice icone

		new 				
Gemini 056	Oz 058	OracleSlim 060	Hulahoop 062	Oracle 063	Frame 064	Fly 066
						
Halo 067	Minor 068	Versus 069	Look 070	Tube 072	Oak 072	Sky 073
new 		new 		new 		
Filo 074	Ultrathin 075	Essence 076	Yoko 077	V-Line 077	Desk 078	Linus 079
						
Karousel 080	Rhapsody 081	Fish 082	Pop 083	Dynamite 084	Pan 085	Triumph 086
			new 	new 		
Abc 087	Lingotto 088	Igor 089	Birds 090	Perlage 091	Copernico 092	Equinoxe 093
						
Kepler 094	Spark 095	Leaves 096	Pauline 096	Vortex 097	Dust 097	Disco 098
						
Konse 099	World 099	Clarissa 100	Onion 101	Ampolla 102	Ice 103	Citrus 104
						
Lugano 105	Frida 106	Doc 106	Edison 107	Hugo 107	Minimal 108	Mr Jack 109

Interni

Indice icone

			<small>new</small> 			<small>new</small> 
Oil 110	Tall 112	A-Line 112	Diesis 113	Holly 114	Triade 115	Yurta 114
						
Navy 118	Fisherman 119	Eris 120	Moby 121	Fiordi 122	Sailor 123	Cantina 124
						
Iguazù 127	Gocce 127	Cono 128	Kuky 129	Milk 130	Tristan 130	Cocktail 131
				<small>new</small> 		
Origami 134	Umile 135	Blossom 136	Lord 136	Fade 137	Audi-20 138	Eva 138
			<small>new</small> 			
Folk 141	Aria 142	Mama 142	Plissé 143	Lana 144	Lena 145	Smarties 146
						
Candy 149	Clown 150	Bollicine 151	Mapa Plus 151	Luce Max 152	Mapa Sat 153	Mapa Max 153
						
Boa 159	Mapa Riga 159	Grape 160	Loko 160	Nemo Plus 161	Nemo 162	Dna 164
						
Tokyo 167	Dream Big 168	Avion 169	Multiflex 169	Soft 170	Lido 171	Ken 172



Metro 117



Breeze 117



Hangar 118



Brooklyn 125



UpandDown 125



Flam 126



Olimpia 132



Manhattan 132



Flut 133



Tolomeo 139



Karma 140



Etna 140



Glory 147



Ulisse 148



Arizona 148



Mapa Fade 154



Mapa Bianco 156

new



Carta 158



Nodi 165



Ovalino 166



Basket 167



Zeno 172

new



Coco 173



Mint 174



Diesis

Pag 113





Bergen 175



Bistrò 176



Gretel 177



Audi-61 178



Cloe 183



Woody 184



Hilton 185



Wheel 186



Rain 194



Giada 195



Elisir 196



Martinez 197



Dubai 204



Caesar 205



Millennium 206



Monet 207



Continental 215



Tiepolo 216



Amadeus 216



Giudecca 217



Sem 225



Strauss 226



Rialto 227



Casanova 228



Artù 236



Vanity 237



Harem 238



Nawa 239

Coco

Pag 173



Audi-10 178



Audi-80 179



Madame 180



Phoenix 181



London 182



Nordik 182



Cylinder 183



Ekos 187



Set Up 188



Opera 190



Swan 191



Calypso 192



Orion 192



King 193



Carlton 198



Roma 199



Nabucco 200



Pashà 201



Luxor 202



Evasione 203



Audi-77 203



Pegaso 208



Blanche 210



Pantheon 211



Provence 211



Colossal 212



Rose 213



Negresco 214



Florian 218



Napoleon 220



Gioconda 222



Impero 223



Liberty 224



Cascina 224



Corte 225



Doge 229



Danieli 230



Brigitta 231



Miramare 232



Bon Bon 233



Firenze 234



Justine 235



Chalet 240



Driftwood 241



Canapa 242



Electric 243



Corda 243



Norma 244



Stella 245



Deca 245



Anfora 246



Orangerie 247



Rondo 247



Foglia 248



Haunt 249



Gemini

Rosone e paralume in metallo verniciato a polveri o placcato. Diffusore in policarbonato opale. Cavo in pvc trasparente. Disponibile nelle finiture bianco, nero o ottone spazzolato.

LED Sorgente luminosa LED 3000 K, 30.000 h di durata.

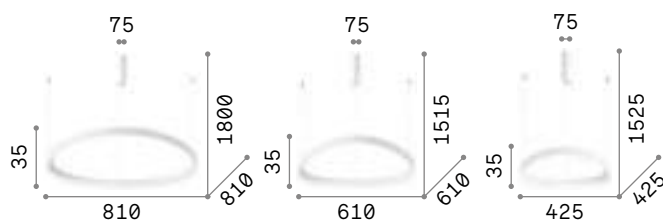

IP20

2,060 Kg / 0,0774 m³
LED 60W / 6200 lm

€ 418

247274 ■ Bianco
247281 ■ Nero
269849 ■ Ottone

IP20

1,710 Kg / 0,0462 m³
LED 48W / 4950 lm

€ 319

247250 ■ Bianco
247267 ■ Nero
269832 ■ Ottone

IP20

1,290 Kg / 0,0230 m³
LED 38W / 3900 lm

€ 231

247229 ■ Bianco
247236 ■ Nero
247243 ■ Ottone



Oz

Base e montatura in metallo verniciato a polveri o placcato. Cavi in pvc. Diffusore in gomma opale. Disponibile nelle finiture bianco, nero o ottone spazzolato.

LED Sorgente luminosa LED 3000 K, 30.000 h di durata.

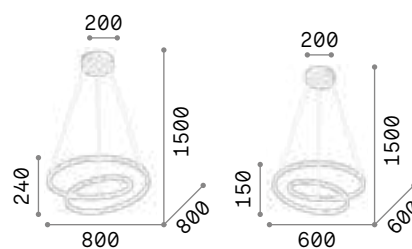

IP20

1,920 Kg / 0,1215 m³
LED 59W / 6000 lm

€ 379,50

253664 ■ Bianco
269450 ■ Nero
269467 ■ Ottone

IP20

1,630 Kg / 0,0676 m³
LED 47W / 5000 lm

€ 319

253671 ■ Bianco
269436 ■ Nero
269443 ■ Ottone



P. 259

P. 339

P. 430

Oracle Slim new

Lampada a sospensione costituita da una montatura sottile in alluminio verniciato bianco o nero opaco e diffusore opale in policarbonato. Disponibile nel modello circolare o quadrato in quattro dimensioni diverse. LED integrati, disponibile in temperatura di colore 3000 K e 4000 K per il modello circolare, CRI ≥ 80, durata utile LED 17.500 h, protezione IP20, classe isolamento II.

Sorgente	LED SMD	Durata LED	17.500 h
Potenza	30W / 66W	Classe	II
Driver incluso	On/Off	isolamento	
Driver disponibili	No	IP	20
Angolo	115°	Materiale	Alluminio
CCT	3000 K / 4000 K		
CRI	≥80		

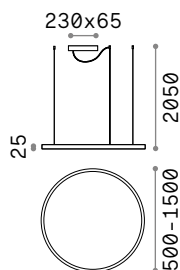

LED SMD Driver ON/OFF incluso

Dimensioni	Peso	Volume	Potenza	Lumen	CCT	Finitura		Codice	€
ø 500	1,400 Kg	0,0130 m³	30 W	2350 lm	3000 K	Bianco		229461	198
					3000 K	Nero		229492	198
				2480 lm	4000 K	Bianco		269856	198
					4000 K	Nero		229485	242
ø 700	1,660 Kg	0,0252 m³	35 W	3050 lm	3000 K	Bianco		229485	242
					3000 K	Nero		229515	242
				3220 lm	4000 K	Bianco		269863	242
					4000 K	Nero		229478	297
ø 900	1,800 Kg	0,0652 m³	51 W	4060 lm	3000 K	Bianco		229478	297
					3000 K	Nero		229508	297
				4280 lm	4000 K	Bianco		269870	297
					4000 K	Nero		265957	484 new
ø 1500	2,480 Kg	0,4096 m³	66 W	6250 lm	3000 K	Bianco		265957	484 new
					3000 K	Nero		285061	484 new
				6600 lm	4000 K	Bianco		285078	484 new

Lunghezza cavo 2500 mm

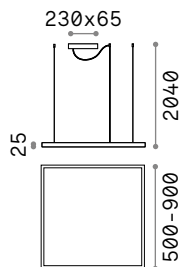

LED SMD Driver ON/OFF incluso

Dimensioni	Peso	Volume	Potenza	Lumen	CCT	Finitura		Codice	€
500 x 500	1,730 Kg	0,0422 m³	33 W	3080 lm	3000 K	Bianco		259154	209
						Nero		259161	209
700 x 700	2,000 Kg	0,0819 m³	41 W	3950 lm	3000 K	Bianco		259178	253
						Nero		259185	253
900 x 900	2,100 Kg	0,1317 m³	51 W	5250 lm	3000 K	Bianco		259192	308
						Nero		259208	308

Lunghezza cavo 2500 mm







Hulahoop

Rosone e montatura in metallo verniciato a polveri con finitura bianca. Diffusore in gomma opale. Cavi in acciaio con supporti a soffitto. Cavo elettrico in pvc trasparente.

LED Sorgente luminosa LED 3000 K, 17.500 h di durata.

IP20	IP20	IP20
2,700 Kg / 0,1603 m³ LED 50W / 5000 lm	1,800 Kg / 0,1060 m³ LED 40W / 4000 lm	1,400 Kg / 0,0628 m³ LED 30W / 3000 lm
€ 308	€ 275	€ 187
258751 Bianco	258768 Bianco	258775 Bianco

Oracle Round

Rosone e corpo luce in alluminio verniciato a polveri di colore bianco o nero. Diffusore in materiale plastico color opale. Sorgente luminosa a led integrati.

LED Sorgente luminosa LED 3000 K, 20.000 h di durata.

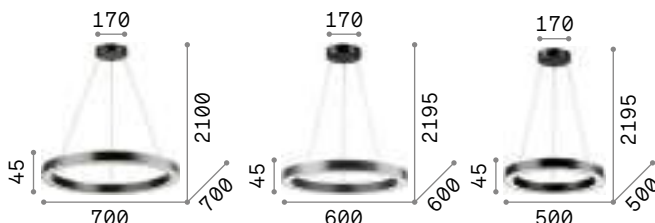

IP20

2,160 Kg / 0,0353 m³
LED 43W / 3850 lm

€ 478,50

211381 Bianco
222110 Nero

IP20

1,870 Kg / 0,0260 m³
LED 38W / 3300 lm

€ 412,50

211398 Bianco
222103 Nero

IP20

1,640 Kg / 0,0169 m³
LED 31W / 2850 lm

€ 346,50

211404 Bianco
222097 Nero



Oracle Square

Rosone e corpo luce in alluminio verniciato a polveri di colore bianco o nero. Diffusore in materiale plastico color opale. Sorgente luminosa a led integrati.

LED Sorgente luminosa LED 3000 K, 30.000 h di durata.

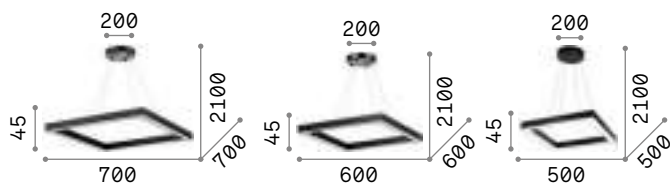

IP20

3,400 Kg / 0,0306 m³
LED 43W / 3900 lm

€ 528

245706 Bianco
245713 Nero

IP20

2,870 Kg / 0,0220 m³
LED 39W / 3500 lm

€ 434,50

245683 Bianco
245690 Nero

IP20

2,460 Kg / 0,0169 m³
LED 35W / 3200 lm

€ 368,50

245669 Bianco
245676 Nero





Frame

Base e montatura in metallo verniciato bianco opaco o nero opaco. Diffusori in materiale plastico colore opale. Cavi regolabili in lunghezza. Emissione luce diretta.

LED Sorgente luminosa LED 3000 K, 30.000 h di durata.

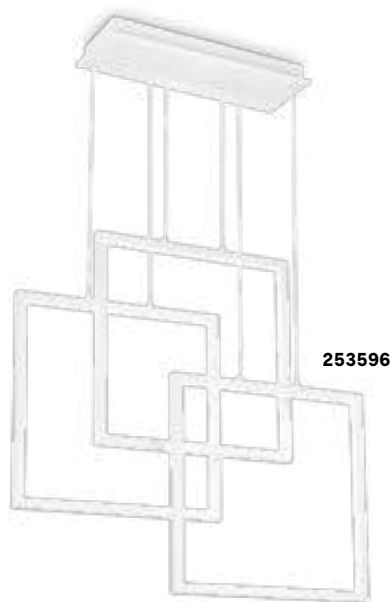
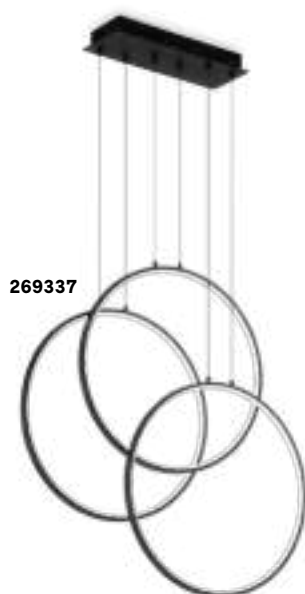

IP20	IP20	IP20
3,500 Kg / 0,1050 m³ LED 82W / 8000 lm	4,270 Kg / 0,0689 m³ LED 80W / 8600 lm	4,300 Kg / 0,2100 m³ LED 93W / 9600 lm
€ 363	€ 533,50	€ 544,50
269351 Bianco 269337 Nero	253596 Bianco 269375 Nero	253589 Bianco 269382 Nero





Fly

Lampada a sospensione con base circolare e corpo luce in alluminio verniciato a polveri. Diffusore in PMMA microprismatizzato con controllo dell'abbagliamento (UGR < 19). Sorgente luminosa a LED integrati; CRI ≥ 90; protezione IP40, classe isolamento I.

LED Sorgente luminosa LED 3000/4000 K, 50.000 h di durata.

IP40 Grado di protezione IP40.



P. 260

IP40	IP40	IP40	IP40
8,400 Kg / 0,0919 m³ LED 68W / 10400 / 10800 Lm	6,000 Kg / 0,0439 m³ LED 50W / 8000 / 8400 Lm	5,200 Kg / 0,0266 m³ LED 26W / 4000 / 4200 Lm	4,500 Kg / 0,0176 m³ LED 18W / 2600 / 2800 Lm
€ 1210	€ 645,50	€ 467,50	€ 363
276625 3000K 276632 4000K	276601 3000K 276618 4000K	276588 3000K 276595 4000K	276564 3000K 276571 4000K







Halo

Lampada a sospensione con base circolare e corpo luce in alluminio verniciato a polveri. Diffusore opale in policarbonato. Sorgente luminosa a LED integrati con binning iniziale \leq 2-Step MacAdam; CRI \geq 80.

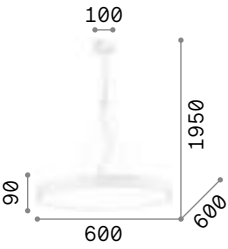
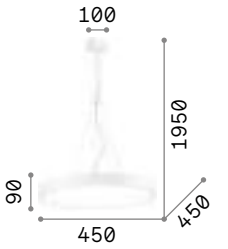
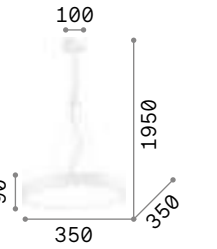
LED Sorgente luminosa LED 3000/4000 K, 35.000 h di durata.

 Luce indiretta inclusa.

		
100 1950 90 600 600	100 1950 90 450 450	100 1950 90 350 350
 IP20	 IP20	 IP20
7,100 Kg / 0,0583 m³	4,930 Kg / 0,0329 m³	3,250 Kg / 0,0194 m³
LED 44W / 4300/5000 Lm	LED 31W / 2800/3200 Lm	LED 25W / 2200/2500 Lm
€ 577,50	€ 424,60	€ 327,80
226743 Bianco 3000K 226750 Bianco 4000K	226729 Bianco 3000K 226736 Bianco 4000K	226712 Bianco 3000K 223254 Bianco 4000K





Minor

Montatura in metallo verniciato a polveri. Cavo elettrico in pvc. Sorgenti luminose a LED sostituibili.

LED Lampadine LED GX53 7W 3000 K incluse. Cod. **101385**

IP20 <small>INCLUSA</small>	IP20 <small>INCLUSA</small>	IP20 <small>INCLUSA</small>	IP20 <small>INCLUSA</small>
3,440 Kg / 0,1200 m³ GX53 max 8 x 15W	2,250 Kg / 0,0564 m³ GX53 max 5 x 15W	2,210 Kg / 0,0203 m³ GX53 max 6 x 15W	1,650 Kg / 0,0135 m³ GX53 max 4 x 15W
€ 478,50	€ 324,50	€ 324,50	€ 247,50
235547 ■ Nero	235516 ■ Nero	235486 ■ Nero	235455 ■ Nero
3000 K 560 lm	3000 K 560 lm	3000 K 560 lm	3000 K 560 lm
101385 € 7,37	101385 € 7,37	101385 € 7,37	101385 € 7,37



Versus

Montatura in metallo cromato.
Elementi decorativi con catenine
metalliche a maglia quadrata. Cavi
in acciaio regolabili in altezza da
dispositivi blocca cavo automatici.

LED Sorgente luminosa LED 3000 K,
30.000 h di durata.

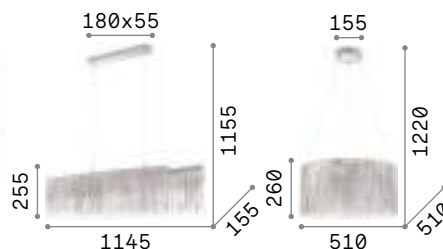

IP20

4,450 Kg / 0,0445 m³
LED 43,2W / 4300 lm

€ 742,50

137056 Cromo

IP20

3,200 Kg / 0,0370 m³
LED 33,6W / 3300 lm

€ 544,50

137032 Cromo



070

Look

Rosone e diffusore in metallo con varie finiture. Cavo in tessuto regolabile in lunghezza. Monta lampadine sostituibili. Modello con finitura cromo sfumato con diffusore in vetro.

LED Lampadine LED GU10 5W e GU10 13W 3000 K incluse.



104935 104942 141800 104928 141817 259239 141794 141855 170589

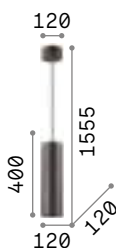

2,950 Kg / 0,0092 m³
GU10 max 1x50W

€ 132

158723 ■ Nero

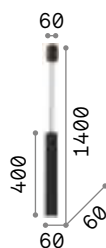

0,990 Kg / 0,0029 m³
GU10 max 1x28W

€ 71,50

104935 ■ Bianco
104942 ■ Cromo
104928 ■ Nero

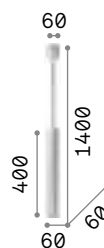

0,990 Kg / 0,0029 m³
GU10 max 1x28W

€ 93,50

194806 ■ Trasparen.
141800 ■ Argento
141817 ■ Oro
259239 ■ Ottone Sat.
141794 ■ Brunito
141855 ■ Rame
170589 ■ Corten



3000 K
950 lm

189031

€ 16,50



3000 K
480 lm

108292

€ 4,95



3000 K
480 lm

108292

€ 4,95



P. 290

P. 357

P. 603

Tube

Rosone e corpo luce in alluminio verniciato a polveri di colore bianco o nero. Cavo in tessuto. Sorgente luminosa a led integrati.

LED Sorgente luminosa LED 3000 K, 35.000 h di durata.

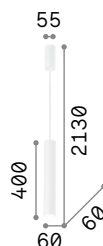

IP20

0,960 Kg / 0,0073 m³
LED 9W / 1200 lm

€ 202,40

211701 ■ Bianco
211718 ■ Nero

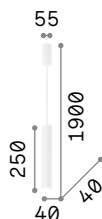

IP20

0,680 Kg / 0,0048 m³
LED 9W / 1200 lm

€ 141,90

211459 ■ Bianco
211466 ■ Nero

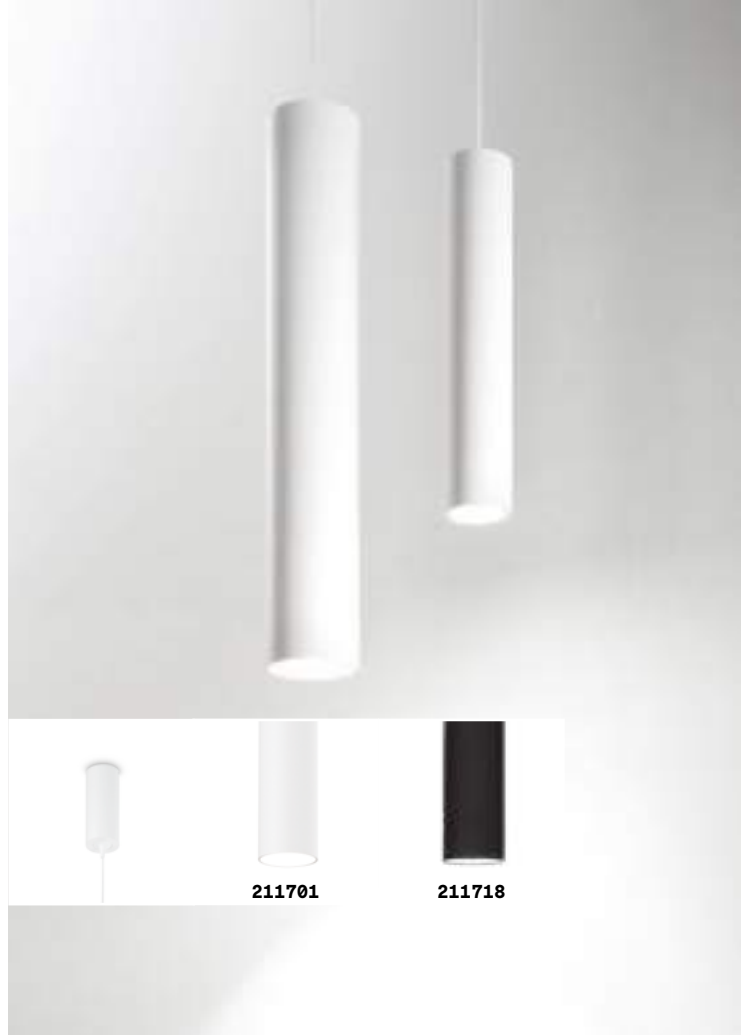

Oak

Rosone in metallo rifinito con vernice opaca. Diffusore in cemento. Cavo in tessuto nero.

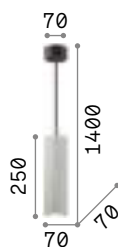

IP20

1,220 Kg / 0,0055 m³
GU10 max 1x 35W

€ 82,50

150635 ■ Cemento

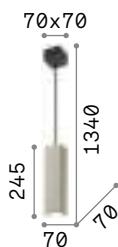

IP20

1,720 Kg / 0,0055 m³
GU10 max 1x 35W

€ 82,50

150673 ■ Cemento

3000 K
480 lm
108292 € 4,95

3000 K
480 lm
108292 € 4,95



P. 294





Sky

Rosone e diffusore in metallo placcato, verniciato opaco o decorato in foglia d'oro o d'argento.

LED Lampadine LED GU10 5W 3000 K incluse. Cod. **108292**



126906 126913 136936 259017

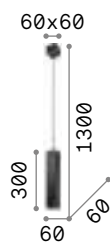

0,950 Kg / 0,0043 m³
GU10 max 1x28W

€ 95,70

126906 Bianco
126913 Nero
136936 Oro
259017 OttoneSat.

3000 K
480 lm
108292 € 4,95



P. 291

P. 356



Filo **new**

Base e corpi luci in metallo verniciato a polveri o placcato. Cavi elettrici in pvc nero. Colori: bianco, nero oppure ottone satinato.

LED Sorgente luminosa LED 3000 K, 20.000 h di durata.

263687

263670

263700

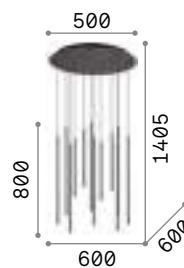

IP20

8,600 Kg / 0,1232 m³
LED 23W / 2400 lm

€ 687,50

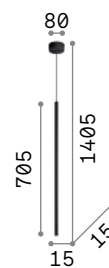

IP20

0,530 Kg / 0,0142 m³
LED 3,5W / 400 lm

€ 121

263441	■ Bianco	new	263687	■ Bianco	new
263434	■ Nero	new	263670	■ Nero	new
263663	■ Ottone	new	263700	■ Ottone	new



Ultrathin

Rosone e diffusore in metallo placcato cromo o rifinito con vernice opaca bianco o nero. Cavo elettrico in tessuto.

LED Sorgente luminosa LED 3000 K, 30.000 h di durata.



142913, 156699 194196, 194202

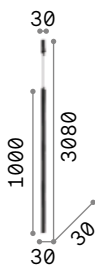

IP20

0,670 Kg / 0,0036 m³
LED 11,5W / 1000 lm / 51°

€ 121

142906 ■ Bianco
164878 ■ Cromo
142913 ■ Nero

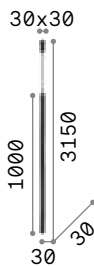

IP20

0,860 Kg / 0,0036 m³
LED 11,5W / 1000 lm / 51°

€ 176

194172 ■ Bianco
194196 ■ Nero

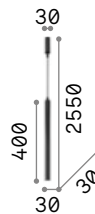

IP20

0,460 Kg / 0,0036 m³
LED 11,5W / 1000 lm / 51°

€ 93,50

156682 ■ Bianco
187662 ■ Cromo
156699 ■ Nero

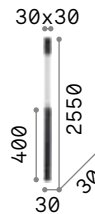

IP20

0,450 Kg / 0,0019 m³
LED 11,5W / 1000 lm / 51°

€ 148,50

194189 ■ Bianco
194202 ■ Nero



Essence ^{new}

Rosone e corpo luce in alluminio verniciato a polveri. Diffusore in materiale acrilico opale. Cavi in pvc. Colori: bianco o nero.

LED Sorgente luminosa LED 3000 K, 20.000 h di durata.

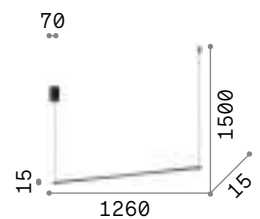
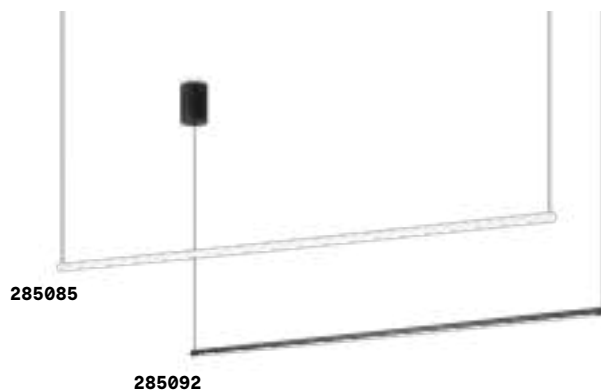

IP20

0,880 Kg / 0,0414 m³
LED 17W / 1600 lm

€ 275

285085 ■ Bianco ^{new}
285092 ■ Nero ^{new}



Yoko

Rosone, montatura e supporto per il cavo in metallo verniciato opaco. Diffusore in policarbonato opale. Cavo in pvc trasparente. Colori: bianco o nero.

LED Sorgente luminosa LED 3000 K, 17.500 h di durata.

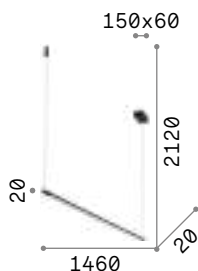

IP20

0,700 Kg / 0,0383 m³
LED 17W / 1500 lm

€ 151,80

258898 ■ Bianco
258928 ■ Nero

P. 433

P. 474



V-Line ^{new}

Corpo luce in alluminio verniciato a polveri o placcato. Diffusore in silicone opale. Cavi d'acciaio con supporti cromati. Cavo elettrico in pvc. Colori: bianco, nero oppure ottone spazzolato.

LED Sorgente luminosa LED 3000 K, 20.000 h di durata.

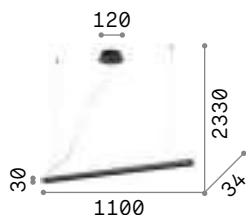

IP20

1,050 Kg / 0,0058 m³
LED 25W / 1450 lm

€ 206,80

275369 ■ Bianco ^{new}
275376 ■ Nero ^{new}
275383 ■ Ottone Sat. ^{new}





Desk

Corpo luce e rosone in alluminio rifinito con vernice a polveri color bianco o nero opaco. Sospensione con cavi elettrici regolabili in lunghezza.

LED Sorgente luminosa LED 3000 K, 30.000 h di durata.



138237



173245

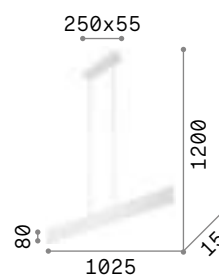

 IP20

1,890 Kg / 0,0196 m³
LED 32W / 2100 lm

€ 336,60

138237  Bianco
173245  Nero



P. 350



Linus

Lampada lineare in alluminio con illuminazione diretta e indiretta. La lampada è modulare e può essere proposta singolarmente oppure in linea continua. LED integrati; binning iniziale \leq 3-Step MacAdam; CRI \geq 80; protezione IP20, classe isolamento I. Alimentatore dimmerabile 1-10V integrato di serie.

LED Sorgente luminosa LED 3000/4000 K, 50.000 h di durata.

☀️ Luce indiretta inclusa.

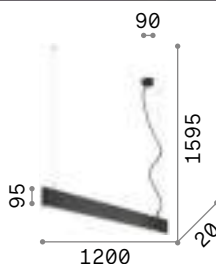

IP20

2,550 Kg / 0,0158 m³
LED 34W / 3850 lm

€ 220

241968 Bianco 3000K
268231 Bianco 4000K
241975 Nero 3000K
268217 Nero 4000K

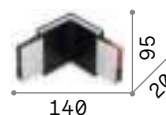

IP20

0,260 Kg / 0,0023 m³
LED 3W / 350 lm

€ 45,10

241999 Bianco 3000K
268149 Bianco 4000K
242002 Nero 3000K
268118 Nero 4000K

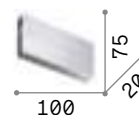

Connector
Non incluso
Optional

€ 5,50

241982



P. 351



Karousel

Montatura in metallo rifinito in ottone satinato. Diffusori in vetro incamiciato bianco, soffiato e acidato.

LED Lampadine LED G9 3W 3000 K incluse.
Cod. **209043**



IP20	IP20
4,340 Kg / 0,1739 m³ G9 max 10 x 15W	2,810 Kg / 0,1055 m³ G9 max 6 x 15W
€ 770	€ 511,50
206394 ■ Ottone Sat.	206387 ■ Ottone Sat.
3000 K 370 lm	3000 K 370 lm
209043 € 4,29	209043 € 4,29



Rhapsody

Montatura in metallo con rosone rifinito ottone satinato e bracci nero opaco. Cavi in pvc. Diffusori in vetro soffiato bianco acidato.

LED Lampadine LED G9 3W 3000 K incluse.
Cod. **209043**

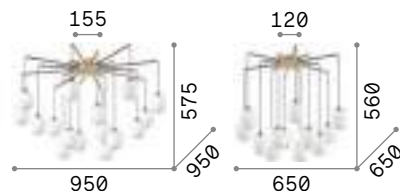

IP20 INCLUSA

5,020 Kg / 0,2040 m³
G9 max 16 x 15W

€ 759

236964 ■ Nero

3000 K
370 lm

209043 € 4,29

IP20 INCLUSA

3,510 Kg / 0,1400 m³
G9 max 12 x 15W

€ 528

236957 ■ Nero

3000 K
370 lm

209043 € 4,29



Fish

Rosone, asta e diffusore in metallo verniciato bianco o nero opaco. Cavo in acciaio con supporto in metallo cromato. Led integrato con schermo opale.

LED Sorgente luminosa LED 3000 K, 20.000 h di durata.



196985



196992

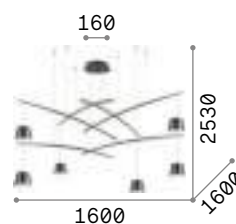

IP20

6,790 Kg / 0,0377 m³
LED 37W / 2800 lm

€ 660

196985 ■ Bianco
196992 ■ Nero



Pop

Rosone, montatura e copri portalampane in metallo rifinito con vernice opaca bianca o nera. Cavi regolabili in lunghezza.



186795

158815



IP20

2,920 Kg / 0,0147 m³
E27 max 10 x 60W

€ 291,50

186801 ■ Bianco
158860 ■ Nero

3000 K
900 lm

123899 € 7,70



IP20

1,670 Kg / 0,0096 m³
E27 max 6 x 60W

€ 183,70

186795 ■ Bianco
158815 ■ Nero

3000 K
900 lm

123899 € 7,70



Dynamite

Montatura in metallo rifinito con vernice a polveri o placcato e spazzolato. Diffusori orientabili. Cavo elettrico in tessuto. Sospensioni con incluso kit per installazione anche a plafone.

LED Lampadine LED GU10 5W 3000 K incluse. Cod. **108292**

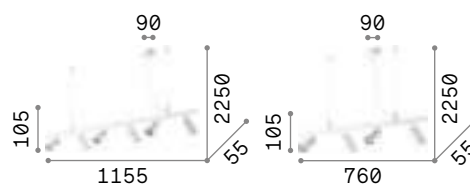

2,700 Kg / 0,0360 m³
GU10 max 6 x 28W

€ 418

231433 Bianco
 231396 Nero
 244648 Ottone Sat.

3000 K
480 lm

108292 € 4,95



2,310 Kg / 0,0243 m³
GU10 max 4 x 28W

€ 308

231372 Bianco
 231341 Nero
 244624 Ottone Sat.

3000 K
480 lm

108292 € 4,95



231433

231396

244648

P. 296



Pan

Montatura in metallo. Diffusori con elementi decorativi a tubi metallici di diverse misure. Cavi d'acciaio regolabili.

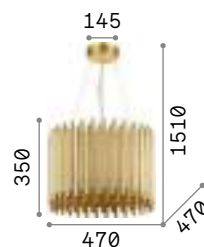

IP20

13,920 Kg / 0,1355 m³
E27 max 5 x 60W

€ 825

208817 Oro

3000 K
910 lm

119571 € 7,70



P. 402



Triumph

Base, bracci e copri porta lampade in metallo con finitura ottone invecchiato.



242347



160269

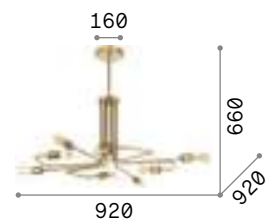

IP20

3,640 Kg / 0,0470 m³
E27 max 8 x 60W

€ 533,50

242347 ■ Nero
160269 ■ Ottone

2200 K
370 lm

151687 € 6,05



P. 308

P. 398



Abc

Rosone, copri portalamapade e struttura decorativa interamente in metallo rifinito ottone satinato. Cavo in tessuto nero.

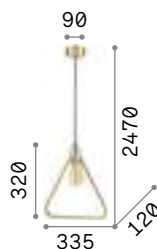

IP20

0,590 Kg / 0,0117 m³
E27 max 1x70W

€ 116,60

207834 Ottone

2200 K
440 lm
151694 € 7,70

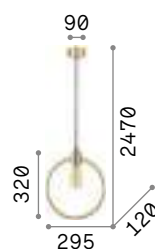

IP20

0,570 Kg / 0,0100 m³
E27 max 1x70W

€ 116,60

207841 Ottone

2200 K
330 lm
151700 € 6,05

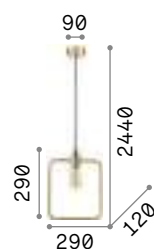

IP20

0,610 Kg / 0,0100 m³
E27 max 1x70W

€ 116,60

207858 Ottone

2200 K
500 lm
151717 € 9,79



Lingotto

Montatura in metallo verniciato: base nera opaca e telaio ottone opaco. Diffusori in vetro incamiciato bianco, soffiato e acidato.

LED Lampadine LED G9 3W 3000 K incluse nei modelli: **251110** e **251103**. Cod. **209043**

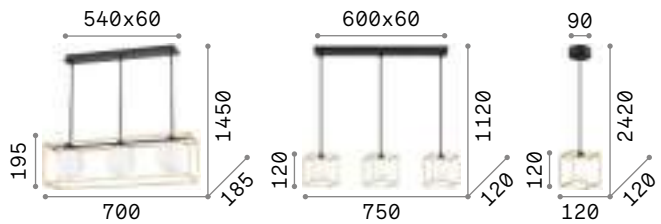

IP20	IP20	IP20
4,530 Kg / 0,0564 m³ E14 max 3 x 40W	2,260 Kg / 0,0442 m³ G9 max 3 x 28W	0,660 Kg / 0,0105 m³ G9 max 1 x 28W
€ 290,40	€ 240,90	€ 91,30
198125 Ottone	251110 Ottone	251103 Ottone
3000 K 420 lm	3000 K 370 lm	3000 K 370 lm
101217 € 3,30	209043 € 4,29	209043 € 4,29



P. 314



P. 447



Igor

Montatura in metallo rifinito con vernice opaca nera. Diffusore con lastre di vetro trasparente.

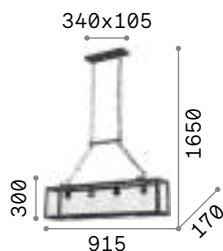

IP20

8,810 Kg / 0,0941m³
E27 max 4 x 60W

€ 372,90

092942 ■ Nero

2200 K
440 lm

151694 € 7,70

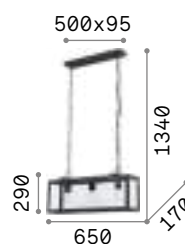

IP20

7,100 Kg / 0,0682m³
E27 max 3 x 60W

€ 290,40

092881 ■ Nero

2200 K
440 lm

151694 € 7,70

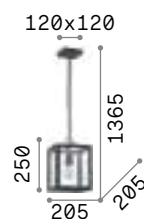

IP20

2,600 Kg / 0,0281m³
E27 max 1 x 60W

€ 145,20

092850 ■ Nero

2200 K
440 lm

151694 € 7,70





Birds new

Montatura in metallo verniciato con disco decorativo in ottone satinato. Diffusori in vetro soffiato bianco acidato. Cavo in pvc con interruttore e spina. Colore: nero opaco con dettaglio ottone satinato.

LED

Lampadine LED G9 3W 3000 K incluse.
Cod. **209043**



P. 309



P. 395



P. 446



P. 472

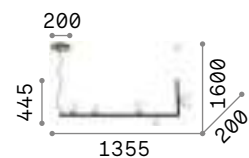

IP20

2,750 Kg / 0,1353 m³
G9 max 5 x 15W

€ 275

273648 ■ Nero new

3000 K
370 lm

209043

€ 4,29



Perlage **new**

Montatura in metallo con struttura lineare a sezione tonda o circolare a sezione quadrata. Diffusori in vetro soffiato. Cavi in acciaio gommati. Cavo elettrico in pvc. Colori: nero opaco oppure ottone satinato.

LED Lampadine LED G9 3W 3000 K incluse. Cod. **209043**

3,400 Kg / 0,1140 m³ G9 max 14 x 15W € 610,50	2,800 Kg / 0,0887 m³ G9 max 11 x 15W € 517	2,200 Kg / 0,0777 m³ G9 max 10 x 15W € 379,50	1,400 Kg / 0,0393 m³ G9 max 6 x 15W € 253
271385 ■ Nero 283814 ■ Ottone Sat.	new 271392 ■ Nero new 283807 ■ Ottone Sat.	new 271408 ■ Nero new 283791 ■ Ottone Sat.	new 271422 ■ Nero new 283821 ■ Ottone Sat.
3000 K 370 lm 209043 € 4,29	3000 K 370 lm 209043 € 4,29	3000 K 370 lm 209043 € 4,29	3000 K 370 lm 209043 € 4,29



P. 397



Copernico

Montatura in metallo verniciato bianco o nero opaco con dettagli in ottone. Diffusori in vetro incamiciato bianco soffiato e acidato.

LED

Lampadine LED G9 3W 3000 K incluse.
Cod. 209043



197302



197319

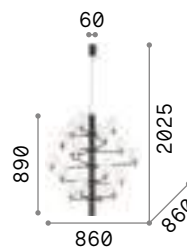

IP20

10,270 Kg / 0,1340 m³
G9 max 20 x 40W

€ 1045

197326 ■ Bianco
197333 ■ Nero

3000 K
370 lm

209043 € 4,29

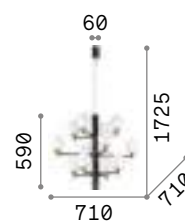

IP20

6,870 Kg / 0,0970 m³
G9 max 12 x 40W

€ 627

197302 ■ Bianco
197319 ■ Nero

3000 K
370 lm

209043 € 4,29



Equinoxe

Montatura a bracci in metallo con finitura cromo o ottone antico. Diffusori in vetro soffiato trasparente.



Lampadine LED G4 2W 3000 K incluse.
Cod. 222257

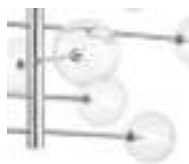

200118



200125

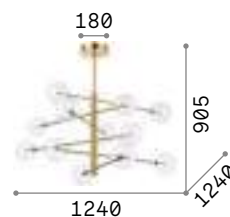

5,540 Kg / 0,1304 m³
G4 max 12 x 2W

€ 907,50

200118 Cromo
200125 Ottone

3000 K
170 lm

222257 € 4,95



P. 399



Kepler

Catena e montatura in metallo verniciato nero opaco. Diffusori in vetro soffiato trasparente ambrato.

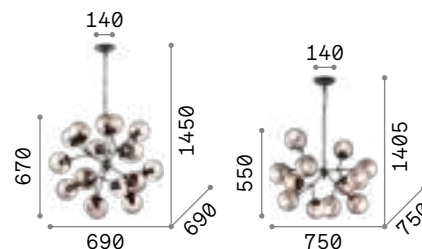

IP20

5,300 Kg / 0,1296 m³
E27 max 18 x 40W

€ 786,50

162478 ■ Nero

3000 K
430 lm

101279 € 3,30

IP20

3,630 Kg / 0,1010 m³
E27 max 12 x 40W

€ 533,50

162201 ■ Nero

3000 K
430 lm

101279 € 3,30



P. 396



Spark

Rosone e montatura in metallo verniciato nero opaco con portalampade placcati. Cavo elettrico rivestito in tessuto.

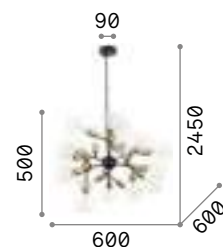

IP20

3,000 Kg / 0,0885 m³
E27 max 24 x 25W

€ 479,60

238241 ■ Nero

3000 K
1120 lm

101323 € 8,25



Leaves

Montatura in metallo bianco.
Elementi decorativi in vetro soffiato bianco e modellato a mano. Cavi d'acciaio regolabili in lunghezza.

LED Lampadine LED G9 3W 3000 K incluse.
Cod. **209043**

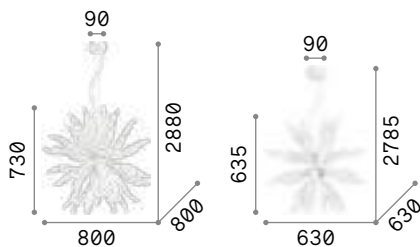

5,800 Kg / 0,1123 m³
G9 max 12 x 40W

€ 880

112268 **Bianco**

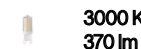

209043 € 4,29



3,700 Kg / 0,0702 m³
G9 max 8 x 40W

€ 583

111957 **Bianco**

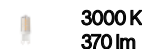

209043 € 4,29



Pauline

Montatura in metallo cromato.
Elementi decorativi in vetro soffiato e modellato a mano. Sospensioni con cavi d'acciaio regolabili in lunghezza.

LED Lampadine LED G9 3W 3000 K incluse.
Cod. **209043**

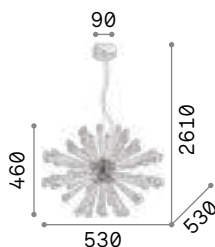

6,300 Kg / 0,0596 m³
G9 max 8 x 40W

€ 638

115801 **Fumè**

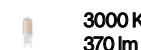

209043 € 4,29



P. 310



Vortex

Montatura in metallo verniciato bianco opaco. Elementi decorativi in metallo modellato artigianalmente e dipinti a mano con oro o argento.

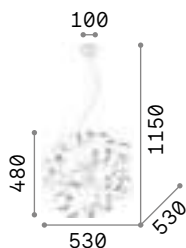

IP20

2,500 Kg / 0,2344 m³

E14 max 6x 40W

€ 236,50

101613 Argento

101606 Oro

3000 K
480 lm

101200 € 3,30



101613



101606



Dust

Montatura in tubolare di alluminio argentato lavorato e modellato artigianalmente. Cavo elettrico regolabile in lunghezza.

LED Lampadine LED G9 3W 3000 K incluse.
Cod. 209043

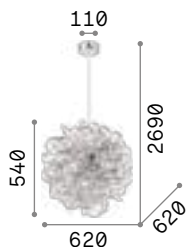

IP20

2,280 Kg / 0,2421 m³

G9 max 12x 40W

€ 732,60

114361 Argento

3000 K
370 lm

209043 € 4,29

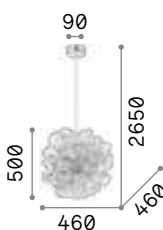

IP20

1,450 Kg / 0,1250 m³

G9 max 8x 40W

€ 443,30

114811 Argento

3000 K
370 lm

209043 € 4,29





Disco

Montatura con elementi decorativi circolari rotanti e posizionabili a piacere. Disponibile in metallo verniciato in bianco o nero opaco oppure in legno naturale sagomato.



138275



103723



114262



IP20

1,240 Kg / 0,0447 m³
E27 max 1x 60W

€ 214,50

138275 ■ Legno

3000 K
950 lm

101330 € 8,80

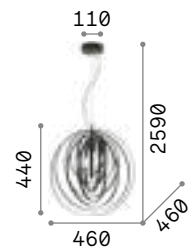

IP20

2,660 Kg / 0,0365 m³
E27 max 1x 60W

€ 258,50

103723 ■ Bianco
114262 ■ Nero

3000 K
950 lm

101330 € 8,80

Konse

Montatura ed elementi decorativi interamente in metallo. Finitura con vernice oro scuro satinato.

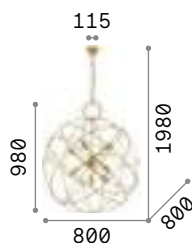

IP20

4,600 Kg / 0,7203 m³
E27 max 7x60W

€ 1078

156033 Oro

3000 K
910 lm

119571 € 7,70

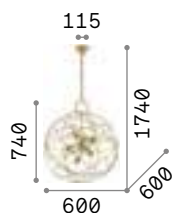

IP20

3,510 Kg / 0,1201 m³
E27 max 6x60W

€ 682

156026 Oro

3000 K
910 lm

119571 € 7,70

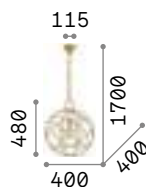

IP20

1,930 Kg / 0,1175 m³
E27 max 1x60W

€ 319

155968 Oro

3000 K
910 lm

119571 € 7,70

World

Montatura in metallo con finitura brunito o cromo. Diffusore in vetro soffiato trasparente. SP4 con paralumi in PVC rivestiti in tessuto. Copricatena in velluto.

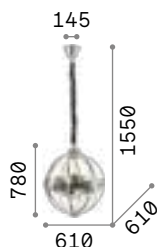

IP20

13,020 Kg / 0,5011 m³
E14 max 4x40W

€ 1320

156347 Cromo
156330 Brunito

3000 K
470 lm

101224 € 3,30

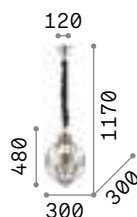

IP20

4,870 Kg / 0,0771 m³
E14 max 3x40W

€ 660

156323 Cromo
156316 Brunito

3000 K
470 lm

101224 € 3,30





Clarissa

Rosone, copri portalampane e diffusore interamente in metallo verniciato bianco opaco o rifinito in rame lucido.

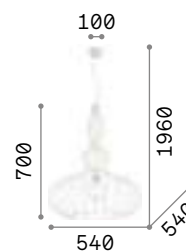

IP20

3,000 Kg / 0,3169 m³
E27 max 1x60W

€ 242

220604 Bianco
220611 Rame

3000 K
1120 Lm

101323 € 8,25



Onion

Struttura in metallo con finitura in vernice marrone ad effetto metallico. Cavo in tessuto.

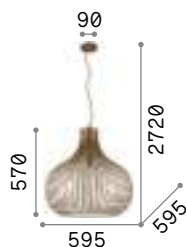

IP20

5,050 Kg / 0,2383 m³
E27 max 1x 60W

€ 401,50

205311 ■ Marrone

2200 K
480 lm

151724 € 10,89

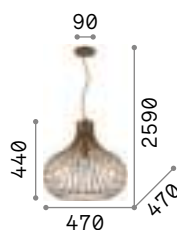

IP20

3,520 Kg / 0,1325 m³
E27 max 1x 60W

€ 269,50

205304 ■ Marrone

2200 K
480 lm

151724 € 10,89

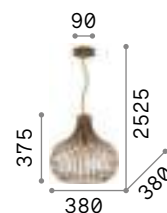

IP20

2,380 Kg / 0,0705 m³
E27 max 1x 60W

€ 176

205298 ■ Marrone

2200 K
500 lm

151717 € 9,79

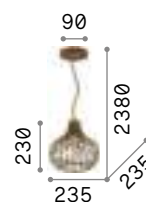

IP20

1,260 Kg / 0,0169 m³
E27 max 1x 60W

€ 93,50

205281 ■ Marrone

2200 K
500 lm

151717 € 9,79



Ampolla

Rosone porta lampade e struttura decorativa in metallo con finitura bianco e nero. Cavo elettrico regolabile in lunghezza.

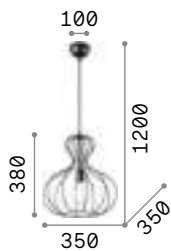

IP20

0,950 Kg / 0,0709 m³
E27 max 1x60W

€ 115,50

194295 ■ Bianco
148502 ■ Nero

2200 K
500 lm
151717 € 9,79

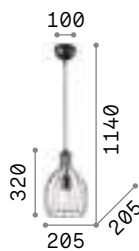

IP20

0,590 Kg / 0,0480 m³
E27 max 1x60W

€ 104,50

200880 ■ Bianco
148151 ■ Nero

2200 K
370 lm
151687 € 6,05

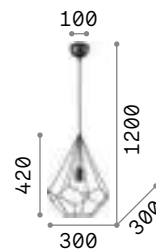

IP20

0,720 Kg / 0,0480 m³
E27 max 1x60W

€ 181,50

200897 ■ Bianco
148175 ■ Nero

2200 K
440 lm
151694 € 7,70



IP20

1,470 Kg / 0,0709 m³
E27 max 1x60W

€ 203,50

200903 ■ Bianco
167497 ■ Nero

2200 K
440 lm
151694 € 7,70



Ice

Rosone e montatura in metallo verniciato bianco o nero opaco. Copri porta lampade in metallo rifinito ottone satinato. Cavo elettrico in pvc.



237671



237664

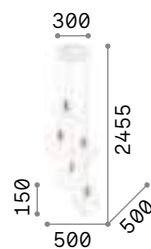

IP20

2,920 Kg / 0,0345 m³
E27 max 5 x 60W

€ 225,50

237671 ■ Bianco
237664 ■ Nero

3000 K
340 lm

101286 € 3,30



Citrus

Rosone in legno naturale. Corpo luce con elementi in multistrato di legno verniciato. Cavo in tessuto nero.

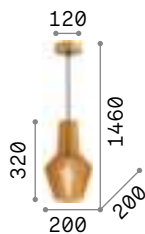

IP20

0,660 Kg / 0,0174 m³
E27 max 1x60W

€ 151,80

159843 Legno

3000 K
910 lm

119571 € 7,70

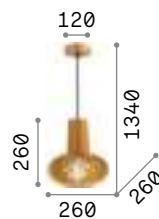

IP20

0,720 Kg / 0,0242 m³
E27 max 1x60W

€ 158,40

159850 Legno

3000 K
910 lm

119571 € 7,70

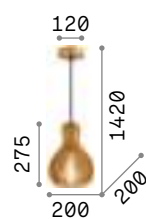

IP20

0,510 Kg / 0,0148 m³
E27 max 1x60W

€ 133,10

159867 Legno

3000 K
910 lm

119571 € 7,70



Lugano

Rosone in metallo verniciato opaco.
Cavo in tessuto con portalampane in metallo brunito. Diffusore in ceramica.

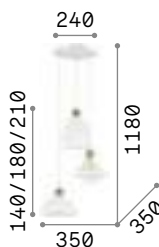

IP20

2,950 Kg / 0,0618 m³
E27 max 3x60W

€ 385

206875 Bianco

3000 K
900 lm
123899 € 7,70

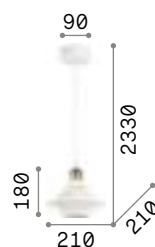

IP20

0,850 Kg / 0,0090 m³
E27 max 1x60W

€ 137,50

206806 Bianco

3000 K
900 lm
123899 € 7,70

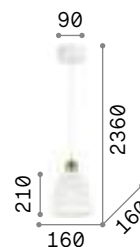

IP20

0,860 Kg / 0,0068 m³
E27 max 1x60W

€ 137,50

206820 Bianco

3000 K
900 lm
123899 € 7,70

Frida

Rosone e copriportalampada in metallo con finitura placcata o in vernice opaca. Cavo in tessuto nero.

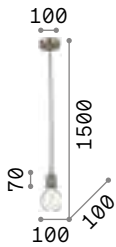

IP20

0,320 Kg / 0,0015 m³
E27 max 1x 60W

€ 36,30

- 139432 Cromo
- 139425 Nero
- 122106 Rame
- 122083 Brunito

2200 K
500 lm

151717

€ 9,79

P. 393



Doc

Rosone e copriportalampada in metallo con finiture varie. Cavo in tessuto nero. Interruttore incorporato al portalampada.

ON
OFF Lampada con interruttore integrato.



IP20

0,220 Kg / 0,0015 m³
E27 max 1x 60W

€ 66

- 163123 Rame
- 163154 Ottone
- 163109 Brunito
- 163161 Piombo

2200 K
350 lm

223933

€ 8,25



Edison

Rosone e copri porta lampada in metallo rifinito con vernice opaca bianca o nera. Cavo elettrico in tessuto.

LED Lampadine LED E27 8W Globo D125 trasparente 3000 K incluse.
Cod. **101347**

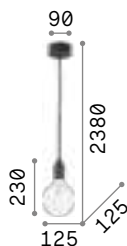

0,320 Kg / 0,0098 m³
E27 max 1x60W

€ 66

113302 **Bianco**
113319 **Nero**

 3000 K
1020 lm

101347 € 9,35

[P. 391](#)



Hugo

Rosone e corpo luce in metallo con finitura in vernice opaca nera. Cavo elettrico rivestito in tessuto.

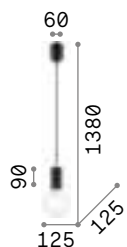

0,380 Kg / 0,0099 m³
E27 max 1x60W

€ 38,50

139685 **Nero**

 3000 K
1020 lm

101347 € 9,35

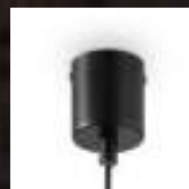



Minimal

Montatura in metallo rifinito in smalto colorato. Cavo elettrico con rivestimento in tessuto. Sospensioni SPI fornite con due metri di cavo.

LED Lampadine LED E27 8W Globo D125 trasparente 3000 K incluse. Cod. **101347**

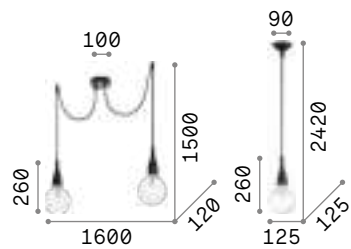

IP20

0,900 Kg / 0,0171 m³
E27 max 2 x 60W

€ 126,50

112718 ■ Bianco
112671 ■ Nero

3000 K
1020 lm

101347 € 9,35

IP20

0,470 Kg / 0,0099 m³
E27 max 1 x 70W

€ 66

009360 ■ Bianco
009407 ■ Nero
009391 ■ Oro

3000 K
1020 lm

101347 € 9,35



P. 392

P. 476



Mr Jack

Montatura e diffusore sferico in metallo rifinito in bianco, cromo o nero. Cavo elettrico rivestito in tessuto.

LED Lampadine LED GU10 5W 3000 K incluse. Cod. **108292**

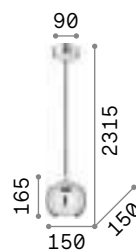

0,890 Kg / 0,0090 m³
GU10 max 1x28W

€ 93,50

231273 Bianco
116464 Cromo
231297 Nero

3000 K
480 lm

108292 € 4,95

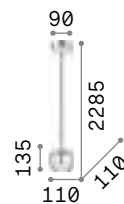

0,520 Kg / 0,0040 m³
GU10 max 1x28W

€ 82,50

231228 Bianco
116457 Cromo
231259 Nero

3000 K
480 lm

108292 € 4,95



Oil

Montatura in metallo con finitura nero opaco. Diffusore in cemento. Per il modello 110462 12 metri di cavo rivestito in tessuto e fornito con sei ganci di fissaggio e spina italiana che può essere sostituita al rosone.

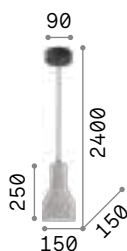

1,780 Kg / 0,0130 m³
E27 max 1x15W

€ 115,50

110417 ■ Cemento

3000 K
430 lm

101279 € 3,30

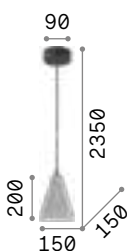

1,180 Kg / 0,0119 m³
E27 max 1x15W

€ 115,50

110424 ■ Cemento

3000 K
430 lm

101279 € 3,30

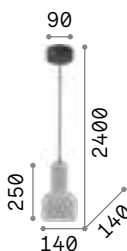

1,810 Kg / 0,0130 m³
E27 max 1x15W

€ 115,50

110431 ■ Cemento

3000 K
430 lm

101279 € 3,30

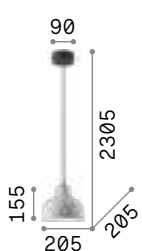

1,650 Kg / 0,0165 m³
E27 max 1x15W

€ 115,50

129082 ■ Cemento

3000 K
430 lm

101279 € 3,30

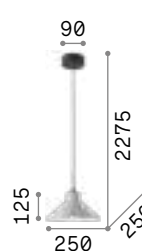

1,760 Kg / 0,0236 m³
E27 max 1x15W

€ 115,50

129099 ■ Cemento

3000 K
430 lm

101279 € 3,30



1,490 Kg / 0,0111 m³
GU10 max 1x15W

€ 137,50

110462 ■ Cemento

3000 K
480 lm

108292 € 4,95

Tall

Diffusore e dettagli in metallo verniciato bianco o nero opaco. Modello 196794 e 196800 con led integrato e schermo opale. Modello 196770 e 196787 aperto e con lampadina sostituibile.

LED Sorgente luminosa LED 3000 K nel modello **196794** e **196800**, 20.000 h di durata.

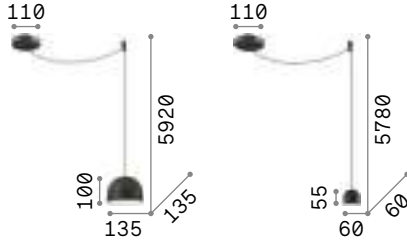

IP20

IP20

0,550 Kg / 0,0036 m³
E27 max 1x 42W

€ 129,80

196770 ■ Bianco
196787 ■ Nero

0,500 Kg / 0,0024 m³
LED 4,5W / 510lm

€ 150,70

196794 ■ Bianco
196800 ■ Nero

3000 K
340 lm
101286 € 3,30



A-Line

Rosone in metallo verniciato a polveri. Diffusore in metallo verniciato bianco o nero opaco con interno bianco. Cavo rivestito in tessuto.

LED Lampadine LED GU10 5W 3000 K incluse nei modelli: **232690** e **232713**. Cod. **108292**

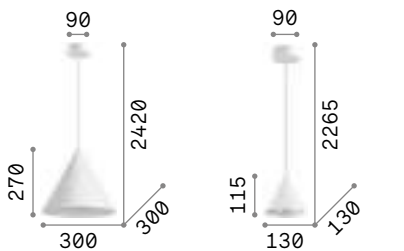

IP20

IP20

1,080 Kg / 0,0491 m³
E27 max 1x 60W

€ 73,70

232720 ■ Bianco
232744 ■ Nero

0,330 Kg / 0,0114 m³
GU10 max 1x 28W

€ 51,70

232690 ■ Bianco
232713 ■ Nero

3000 K
900 lm
123899 € 7,70

3000 K
480 lm
108292 € 4,95





Diesis new

Rosone e diffusore in metallo verniciato a polveri o placcato. Cavo in pvc nero. Colori: nero, nichel satinato oppure ottone satinato.

LED Sorgente luminosa LED 3000 K, 20.000 h di durata.



285122



279770



279794

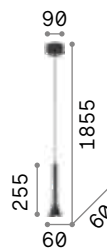

IP20

0,450 Kg / 0,0054 m³
LED 7W / 660 lm

€ 93,50

285122 ■ Nickel new
279770 ■ Nero new
279794 ■ Ottone Sat. new



P. 477



Holly

Rosone e diffusori in metallo con finitura ottone spazzolato o verniciato a polveri con finitura bianca o nera. Cavi rivestiti in tessuto.

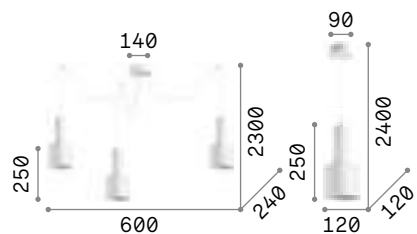

IP20

2,740 Kg / 0,0254 m³
E27 max 3 x 60W

€ 181,50

231587 ■ Bianco
231594 ■ Nero
231600 ■ OttoneSat.

3000 K
900 lm

123899 € 7,70

IP20

0,780 Kg / 0,0064 m³
E27 max 1 x 60W

€ 71,50

231556 ■ Bianco
231563 ■ Nero
231570 ■ OttoneSat.

3000 K
900 lm

123899 € 7,70



Triade

Rosone e diffusore in metallo verniciato a polveri con interno bianco. Elemento decorativo a sfera dorato.

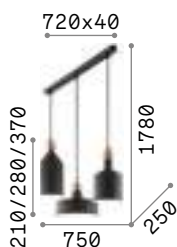

IP20

2,630 Kg / 0,0797 m³
E27 max 3 x 42W

€ 253

194677 ■ Grigio Scuro

3000 K
900 lm

123899 € 7,70

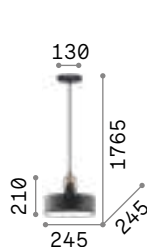

IP20

0,960 Kg / 0,0169 m³
E27 max 1 x 42W

€ 71,50

221489 ■ Grigio Scuro

3000 K
900 lm

123899 € 7,70

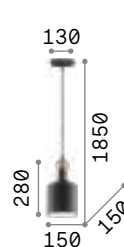

IP20

0,750 Kg / 0,0090 m³
E27 max 1 x 42W

€ 71,50

221496 ■ Grigio Scuro

3000 K
900 lm

123899 € 7,70

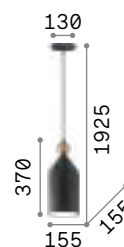

IP20

1,020 Kg / 0,0105 m³
E27 max 1 x 42W

€ 71,50

194684 ■ Grigio Scuro

3000 K
900 lm

123899 € 7,70



Yurta **new**

Rosone e paralume in metallo verniciato a polveri. Cavo in pvc. Colori: tutto bianco o nero con interno bianco.



285146



281568

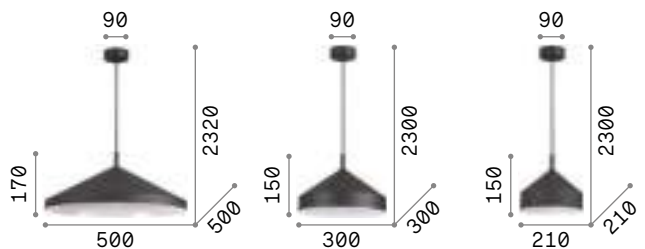

IP20

1,760 Kg / 0,0687 m³
E27 max 1x60W

€ 110

IP20

1,000 Kg / 0,0277 m³
E27 max 1x60W

€ 77

IP20

0,740 Kg / 0,0138 m³
E27 max 1x60W

€ 66

285160 **Bianco** **new** 285153 **Bianco** **new** 285146 **Bianco** **new**
281582 **Nero** **new** 285139 **Nero** **new** 281568 **Nero** **new**

3000 K
900 lm

123899 € 7,70

3000 K
340 lm

101286 € 3,30

3000 K
340 lm

101286 € 3,30

Metro

Montatura e diffusore in metallo.
Interno smaltato in bianco. Cavo
elettrico regolabile in lunghezza.

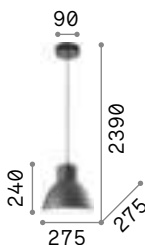

0,970 Kg / 0,0261 m³

E27 max 1x60W

€ 66

139098 ■ Grigio Scuro

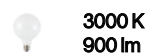

101354 € 9,35



Breeze

Montatura e diffusore in metallo.
Interno smaltato in bianco. Cavo
elettrico regolabile in lunghezza.

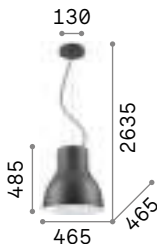

3,490 Kg / 0,0707 m³

E27 max 1x60W

€ 187

232041 ■ Grigio Scuro

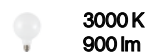

101354 € 9,35

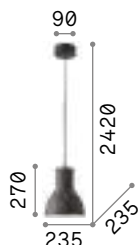

0,790 Kg / 0,0206 m³

E27 max 1x60W

€ 60,50

137681 ■ Grigio Scuro

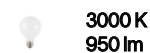

101330 € 8,80



Hangar

Montatura e diffusore in alluminio anodizzato. Interno smaltato bianco. Cavo elettrico regolabile in lunghezza.

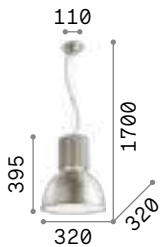

1,800 Kg / 0,0442 m³
E27 max 1x60W

€ 195,80

100326 ■ Alluminio
100333 ■ Nero

3000 K
900 lm

101354 € 9,35



100326



100333

Navy

Montatura e diffusore in metallo con finitura brunito e rame. Interno smaltato bianco. Cavo elettrico regolabile in lunghezza.

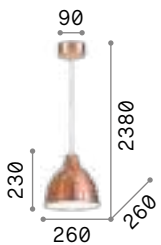

0,800 Kg / 0,0235 m³
E27 max 1x60W

€ 104,50

020747 ■ Rame
020723 ■ Brunito

3000 K
900 lm

101354 € 9,35



020747



020723



Fisherman

Corpo luce interamente in metallo con finitura in cromo, rame o in vernice nera opaca. Diffusore in lastra di vetro serigrafato bianco.



⚡ IP20

5,040 Kg / 0,0899 m³
E27 max 1x60W

€ 385

125824 Cromo
125831 Nero
134871 Rame

3000 K
1120 lm

101323 € 8,25



Eris

Montatura in metallo con rosone e diffusore verniciati bianco o nero opaco, dettagli in finitura oro satinato. Cavo elettrico intrecciato con rivestimento in tessuto.



238104



249056

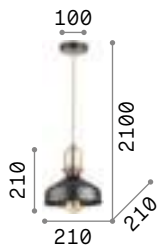

IP20

0,630 Kg / 0,0102 m³
E27 max 1x60W

€ 71,50

238104 ■ Bianco
249056 ■ Nero

3000 K
340 lm

101286 € 3,30



IP20

1,080 Kg / 0,0257 m³
E27 max 1x60W

€ 82,50

238135 ■ Bianco
249063 ■ Nero

3000 K
950 lm

101330 € 8,80



IP20

0,740 Kg / 0,0126 m³
E27 max 1x60W

€ 71,50

238173 ■ Bianco
249070 ■ Nero

3000 K
340 lm

101286 € 3,30

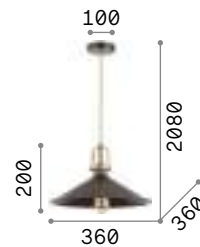

IP20

0,960 Kg / 0,0231 m³
E27 max 1x60W

€ 82,50

238210 ■ Bianco
249087 ■ Nero

3000 K
340 lm

101286 € 3,30



Moby

Montatura e diffusore in metallo con interno bianco. Disponibile nelle finiture alluminio, bianco, nero o rame.

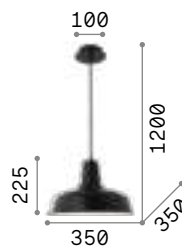

IP20

1,200 Kg / 0,0356 m³
E27 max 1x 60W

€ 126,50

102047 Bianco
102054 Alluminio
093659 Nero
093697 Rame



102047



102054



093659



093697

3000 K
950 lm

101330 € 8,80



Fiordi

Corpo luce in metallo, disponibile con finitura in brunito. Diffusore in vetro trasparente soffiato e rifinito artigianalmente.

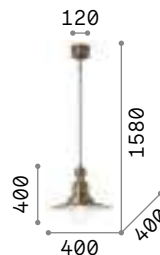

 IP20

2,370 Kg / 0,0464 m³
E27 max 1x60W

€ 258,50

005041  Brunito

 3000 K
910 lm

119571 € 7,70



Sailor

Corpo luce a cupola in metallo con finitura brunito e rame e smaltato bianco all'interno. Diffusore in vetro soffiato con effetto rustico.



025278



025308

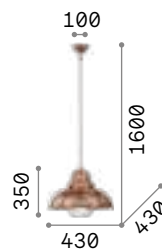

IP20

2,920 Kg / 0,1060 m³
E27 max 1x60W

€ 275

025315 Rame
025285 Brunito

3000 K
910 lm

119571 € 7,70

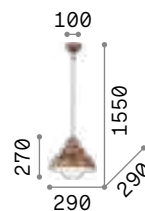

IP20

1,700 Kg / 0,0467 m³
E27 max 1x60W

€ 170,50

025278 Rame
025308 Brunito

3000 K
910 lm

119571 € 7,70



Cantina

Montatura, diffusore e copriportalampada in metallo disponibile con finitura brunito o rame. Cavo elettrico rivestito in tessuto e intrecciato.

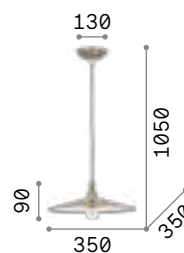

IP20

0,810 Kg / 0,0189 m³
E27 max 1x60W

€ 93,50

112732 Rame
112701 Brunito

3000 K
910 lm

119571 € 7,70



P. 400

Brooklyn

Montatura in metallo con finitura in brunito. Diffusore in cemento. Sospensioni con cavo in tessuto nero.

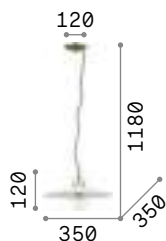

1,930 Kg / 0,0288 m³

E27 max 1x60W

€ 148,50

153445 ■ Cemento

1,070 Kg / 0,0154 m³

E27 max 1x60W

€ 121

153438 ■ Cemento



151694 € 7,70

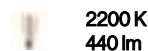

151694 € 7,70



Up and Down

Montatura in metallo rifinito con vernice nera opaca. Copri portalampade e viti in metallo brunito. Diffusori regolabili in altezza individualmente con sistema a contrappeso.

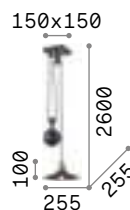
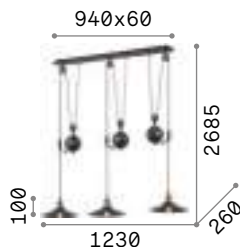

6,760 Kg / 0,0582 m³

E27 max 3x60W

€ 437,80

136349 ■ Nero

1,940 Kg / 0,0151 m³

E27 max 1x60W

€ 148,50

136332 ■ Nero

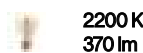

151687 € 6,05

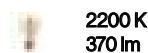

151687 € 6,05





Flam

Montatura in metallo cromato.
 Diffusore in vetro pirex
 trasparente, smerigliato nella zona
 centrale.

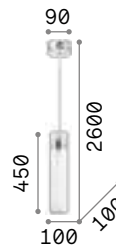

IP20

1,330 Kg / 0,0164 m³
 E27 max 1x 60W

€ 66

027364 Bianco

3000 K
 910 lm

119571 € 7,70

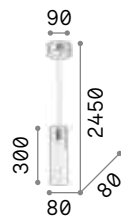

IP20

0,810 Kg / 0,0115 m³
 E27 max 1x 60W

€ 60,50

027357 Bianco

3000 K
 910 lm

119571 € 7,70

Iguazù

Montatura in metallo cromato.
Diffusore in vetro pirex e
pendenti con ottagoni di cristallo.
Sospensioni con cavi a lunghezza
regolabile da dispositivi ferma cavo
automatici.

3,950 Kg / 0,0524 m³ E14 max 4 x 40W	2,940 Kg / 0,0364 m³ E14 max 3 x 40W	0,950 Kg / 0,0126 m³ E14 max 1 x 40W
€ 297	€ 224,40	€ 92,40
052373	052366	052359
3000 K 470 lm	3000 K 470 lm	3000 K 470 lm
101224 € 3,30	101224 € 3,30	101224 € 3,30

Gocce

Montatura in metallo cromato.
Diffusore in tubolare di vetro pirex.
Elementi decorativi con ottagoni
e gocce in cristallo molato. Cavi
elettrici regolabili in lunghezza.

LED Lampadine LED GU10 5W 3000 K
incluse. Cod. **108292**

1,140 Kg / 0,0123 m³ GU10 max 1x28W
€ 126,50
089669
3000 K 480 lm
108292 € 4,95





Cono

Montatura e copri porta lampade in metallo cromato. Diffusore in vetro soffiato a mano. Disponibile in cromo con vetro tutto trasparente.

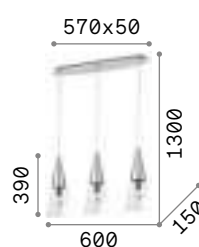

IP20

4,110 Kg / 0,0763 m³
E14 max 3 x 40W

€ 295,90

112367 Cromo

3000 K
300 lm

101255 € 4,95

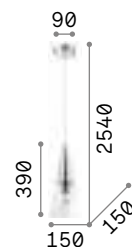

IP20

1,420 Kg / 0,0243 m³
E14 max 1 x 40W

€ 116,60

017440 Cromo

3000 K
300 lm

101255 € 4,95



Kuky

Montatura in metallo cromato.
Disponibile con vetro pirex smerigliato a sabbia nella zona centrale o vetro bianco soffiato e acidato.



023021

053448

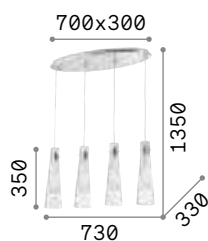

IP20

4,580 Kg / 0,0766 m³
E27 max 4 x 60W

€ 250,80

023038 Trasparen.

3000 K
910 lm

119571 € 7,70

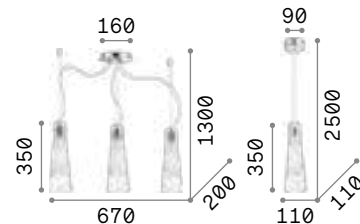

IP20

2,510 Kg / 0,0464 m³
E27 max 3 x 60W

€ 168,30

033952 Trasparen.

3000 K
910 lm

119571 € 7,70

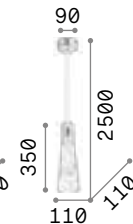

IP20

0,980 Kg / 0,0165 m³
E27 max 1 x 60W

€ 57,20

023021 Trasparen.
053448 Bianco

3000 K
910 lm

119571 € 7,70

Milk

Base ellittica in metallo smaltato bianco. Diffusore in vetro bianco soffiato e acidato. Cavi elettrici regolabili in lunghezza.

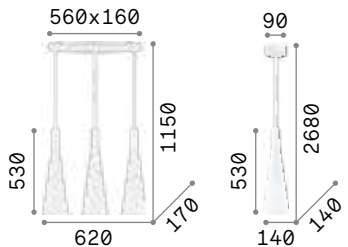

IP20

IP20

4,220 Kg / 0,1024 m³
E27 max 3x60W

1,270 Kg / 0,0354 m³
E27 max 1x60W

€ 264

€ 104,50

030326 Bianco

026787 Bianco

3000 K
900 lm

3000 K
900 lm

123899 € 7,70

123899 € 7,70



Tristan

Rosone e corpo luce in metallo verniciato a polveri. Paralume in acrilico trasparente rigato. Diffusore in policarbonato satinato. Cavo in pvc trasparente. Disponibile nelle finiture bianco, nero o oro metallizzato.

LED

Sorgente luminosa LED 3000 K,
20.000 h di durata.

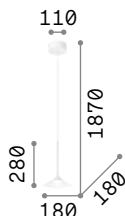

IP20

0,430 Kg / 0,0099 m³
LED 5W / 540 lm

€ 121

256429 Bianco
256436 Nero
256443 Oro



256429

256436

256443





Cocktail

Diffusore in vetro soffiato incamiciato e acidato. Bianco all'interno e colorato all'esterno. Sospensioni con cavi a lunghezza regolabile.



074337



074344

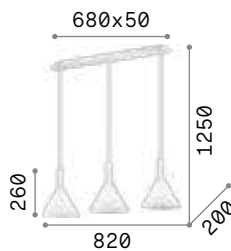

IP20

3,740 Kg / 0,0708 m³
E14 max 3x40W

€ 247,50

074245 ■ Bianco

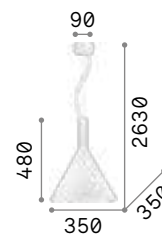

IP20

3,200 Kg / 0,1259 m³
E27 max 1x60W

€ 291,50

074313 ■ Bianco

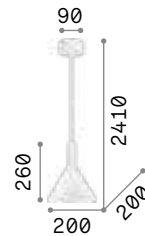

IP20

1,180 Kg / 0,0257 m³
E14 max 1x40W

€ 104,50

074337 ■ Bianco
074344 ■ Nero

3000 K
420 lm
101217 € 3,30

3000 K
900 lm
123899 € 7,70

3000 K
420 lm
101217 € 3,30

Olimpia

Montatura in cromo. Diffusore in vetro colorato soffiato e incamiciato. Cavo elettrico regolabile in lunghezza.

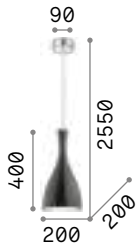

1,080 Kg / 0,0374 m³
E27 max 1x60W

€ 144,10

013244 ■ Bianco
012919 ■ Nero

3000 K
900 lm

123899

€ 7,70



013244

012919



Manhattan

Rosone e diffusore in metallo rifinito con vernice opaca bianca o nera e con dettaglio in legno naturale. Cavo in tessuto.

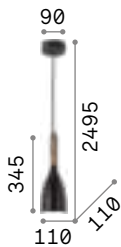

0,560 Kg / 0,0061 m³
E14 max 1x40W

€ 74,80

110745 ■ Bianco
110752 ■ Nero

3000 K
480 lm

101200

€ 3,30



110745

110752





Flut

Diffusore in vetro soffiato incamiciato e acidato, bianco all'interno e colorato all'esterno. Cavo a lunghezza regolabile.

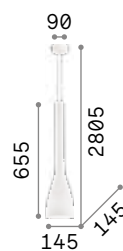

IP20

1,570 Kg / 0,0422 m³
E27 max 1x60W

€ 137,50

035666 ■ Bianco
035680 ■ Nero

3000 K
900 lm

123899 € 7,70

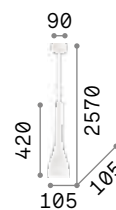

IP20

0,930 Kg / 0,0179 m³
E14 max 1x40W

€ 72,60

035697 ■ Bianco
035710 ■ Nero
035703 ■ Rosso

3000 K
420 lm

101217 € 3,30



Origami

Montatura in metallo verniciato opaco. Diffusori in vetro bianco soffiato e acidato con effetto piegature in rilievo.

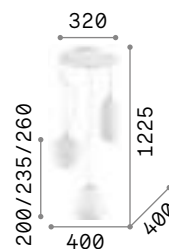

IP20

3,740 Kg / 0,0642 m³
E27 max 3 x 60W

€ 280,50

198095 Bianco

3000 K
900 lm

123899 € 7,70



Umile

Rosone ed elementi decorativi in metallo con finitura oro satinato. Diffusori in vetro soffiato bianco acidato. Led integrati.

LED Sorgente luminosa LED 3000 K, 20.000 h di durata.

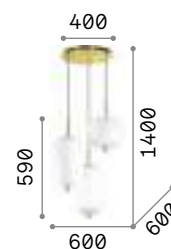

IP20

8,600 Kg / 0,2150 m³
LED 60,2W / 5300 lm

€ 412,50

224541 Bianco

Blossom

Montatura e rosone in metallo cromato. Diffusore in vetro soffiato trasparente con finitura ambra o fumè. Cavo elettrico in pvc trasparente.

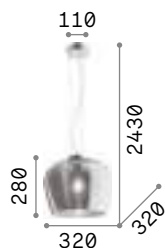

IP20

1,890 Kg / 0,0705 m³

E27 max 1x60W

€ 170,50

241517 ■ Fumè

241524 ■ Ambra

3000 K
900 lm

101354

€ 9,35



241517



241524



Lord

Rosone e montatura in metallo verniciato a polveri con finitura nera. Cavo in pvc nero. Diffusore in vetro soffiato con decori in rilievo. Disponibile con vetro ambra, trasparente o fumè.

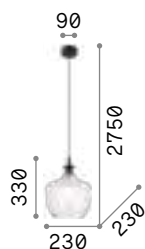

IP20

1,430 Kg / 0,0389 m³

E27 max 1x60W

€ 104,50

263632 ■ Trasparen.

263649 ■ Fumè

263656 ■ Ambra

3000 K
910 lm

119571

€ 7,70





Fade new

Rosone e montatura in metallo. Paralume in vetro soffiato trasparente con sfumatura galvanica. Diffusore interno in vetro soffiato bianco acidato. Cavo in pvc nero. Colori paralumi: trasparente con sfumatura ambra, cromo o rame.

LED Lampadine LED G9 3W 3000 K incluse.
Cod. **209043**

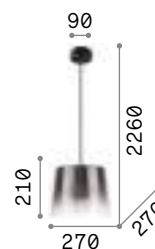

1,900 Kg / 0,0370 m³
G9 max 1x 15W

€ 198

271293 **Cromo** new
271316 **Ambra** new
271309 **Rame** new

3000 K
370 lm
209043 € 4,29

Audi-20

Elemento centrale portalampada in metallo cromato. Diffusore in vetro soffiato trasparente o cromo sfumato. Cavo in acciaio a lunghezza regolabile con dispositivo ferma cavo automatico.

LED Lampadine LED E27 8W Globo D125 3000 K incluse. Cod. **101347/101354**

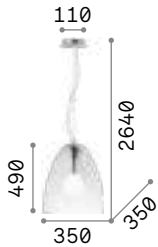

4,370 Kg / 0,1017 m³
E27 max 1x60W

€ 278,30

016931 **Trasparen.**
103990 **CromoSfum.**

3000 K
900 lm

101354

€ 9,35



016931



103990



Eva

Montatura in metallo cromato. Diffusore in vetro soffiato in vetro trasparente con effetto fumè. Cavi in acciaio a lunghezza regolabile da dispositivi automatici.

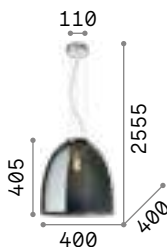

5,750 Kg / 0,1201 m³
E27 max 1x60W

€ 389,40

101095 **Fumè**

3000 K
1020 lm

101347

€ 9,35

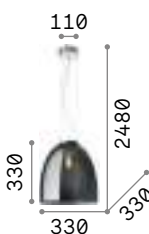

3,600 Kg / 0,0741 m³
E27 max 1x60W

€ 302,50

101101 **Fumè**

3000 K
1020 lm

101347

€ 9,35





Tolomeo

Diffusore in vetro soffiato, incamiciato e decorato a mano. Cavi in acciaio a lunghezza regolabile con dispositivi ferma cavo automatici.



IP20

3,390 Kg / 0,0871 m³
E27 max 1x60W

€ 273,90

001814 ■ Bianco
001821 ■ Grigio

3000 K
900 lm

101354 € 9,35

Karma

Montatura in metallo cromato.
Diffusore in vetro soffiato bianco incamiciato e acidato.
Cavi in acciaio a lunghezza regolabile da dispositivi ferma cavo automatici.

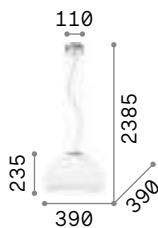

4,310 Kg / 0,1185 m³
E27 max 1x60W

3,700 Kg / 0,0693 m³
E27 max 1x60W

€ 247,50

€ 247,50

132365 Bianco

132389 Bianco

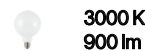

101354 € 9,35

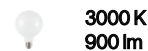

101354 € 9,35



Etna

Montatura in metallo con finitura nickel satinato.
Diffusore in vetro bianco soffiato e acidato.

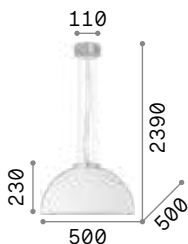

4,390 Kg / 0,1072 m³
E27 max 1x60W

€ 342,10

027906 Bianco

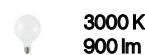

101354 € 9,35





Folk

Rosone e diffusore in metallo decorato con effetto ossidato oppure con vernice opaca bianca. Parabola interna ondulata e smaltata bianca. Cavo in tessuto.



174228



103136

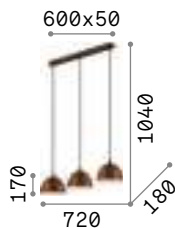

IP20

2,190 Kg / 0,0255 m³
E27 max 3 x 60W

€ 236,50

174235 ■ Corten

3000 K
340 lm

101286 € 3,30

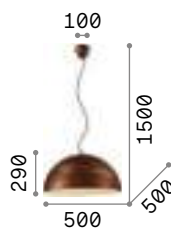

IP20

3,070 Kg / 0,0843 m³
E27 max 1 x 60W

€ 280,50

174228 ■ Corten
103136 ■ Bianco

3000 K
900 lm

101354 € 9,35

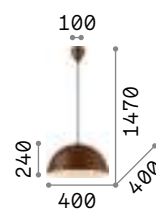

IP20

1,980 Kg / 0,0420 m³
E27 max 1 x 60W

€ 154

174211 ■ Corten
103112 ■ Bianco

3000 K
950 lm

101330 € 8,80

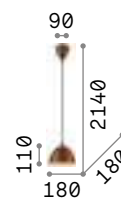

IP20

0,530 Kg / 0,0072 m³
E27 max 1 x 60W

€ 82,50

174204 ■ Corten

3000 K
900 lm

123899 € 7,70

Aria

Diffusore in vetro bianco soffiato e acidato. Cavi in acciaio a lunghezza regolabile con dispositivi ferma cavo automatici.

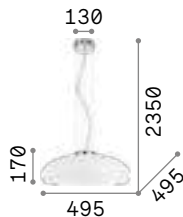

IP20

4,080 Kg / 0,0847 m³

E27 max 1x 60W

€ 280,50

059679 Bianco

3000 K
950 lm

101330 € 8,80



Mama

Montatura e anello sul bordo inferiore in metallo rifinito con smalto bianco satinato. Diffusore in vetro bianco soffiato e acidato. Cavi in acciaio a lunghezza regolabile da dispositivi automatici.

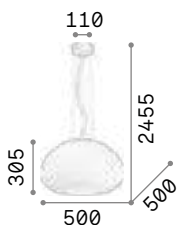

IP20

4,170 Kg / 0,1223 m³

E27 max 3x 60W

€ 371,80

071022 Bianco

3000 K
900 lm

101354 € 9,35



IP20

2,810 Kg / 0,0722 m³

E27 max 1x 60W

€ 195,80

071015 Bianco

3000 K
950 lm

101330 € 8,80





Plissé **new**

Montatura in metallo placcato.
Diffusore in vetro soffiato bianco acidato, con decoro in rilievo. Cavo elettrico in pvc trasparente. Colori: cromo oppure ottone satinato.



264509



285177

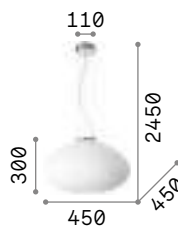

IP20

3,300 Kg / 0,1208 m³
E27 max 1x60W

€ 242

264523 || Cromo
285191 || Ottone Sat.

3000 K
900 lm

123899 € 7,70

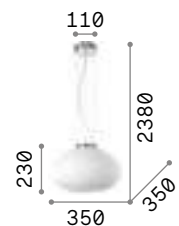

IP20

2,060 Kg / 0,0705 m³
E27 max 1x60W

€ 176

new 285184 || Cromo
new 264547 || Ottone Sat.

3000 K
900 lm

123899 € 7,70

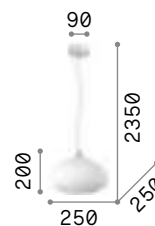

IP20

1,200 Kg / 0,0394 m³
E14 max 1x40W

€ 88

new 264509 || Cromo
new 285177 || Ottone Sat.

3000 K
420 lm

101217 € 3,30

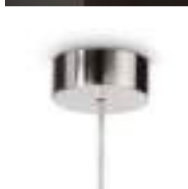

Lana

Diffusore in vetro trasparente con decorazioni serigrafate all'interno e sabbiate all'esterno. Ganci ferma vetro in metallo cromato.

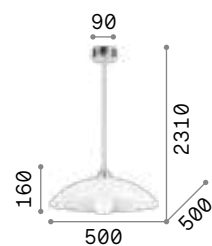
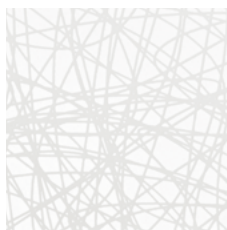

IP20

2,720 Kg / 0,0533 m³
E27 max 1x60W

€ 115,50

068169 Bianco

3000 K
950 lm

101330 € 8,80



P. 286



Lena

Montatura in metallo cromato.
Diffusore con doppio vetro:
smerigliato e colorato quello
esterno, bianco quello interno.
Sospensioni con cavi in acciaio a
lunghezza regolabile da dispositivi
automatici.

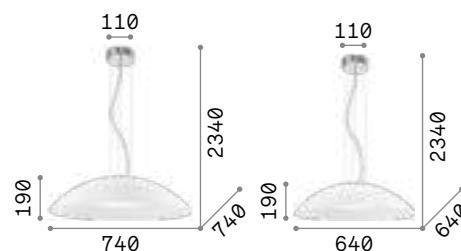

IP20

8,310 Kg / 0,1785 m³
E27 max 3x60W

€ 407

052786 ■ Bianco

3000 K
340 lm

101286 € 3,30

IP20

6,600 Kg / 0,1304 m³
E27 max 3x60W

€ 346,50

035727 ■ Bianco
066592 ■ Grigio
066608 ■ Marrone

3000 K
340 lm

101286 € 3,30



035727



066592



066608



Smarties

Montatura in metallo verniciato bianco. Diffusore in vetro bianco soffiato. Cavi in acciaio a lunghezza regolabile con dispositivi ferma cavo automatici.

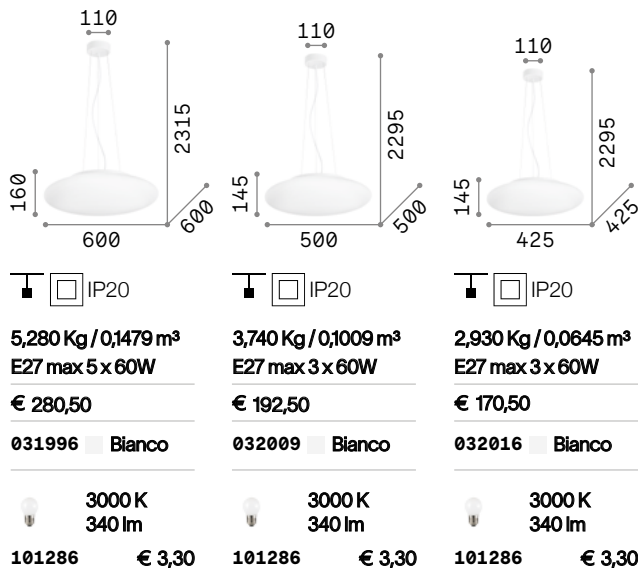

P. 279



P. 360



P. 440



Glory

Montatura rifinita in nickel satinato. Diffusore in vetro bianco soffiato e acidato. Sospensioni con cavi in acciaio regolabili in lunghezza con dispositivi automatici.

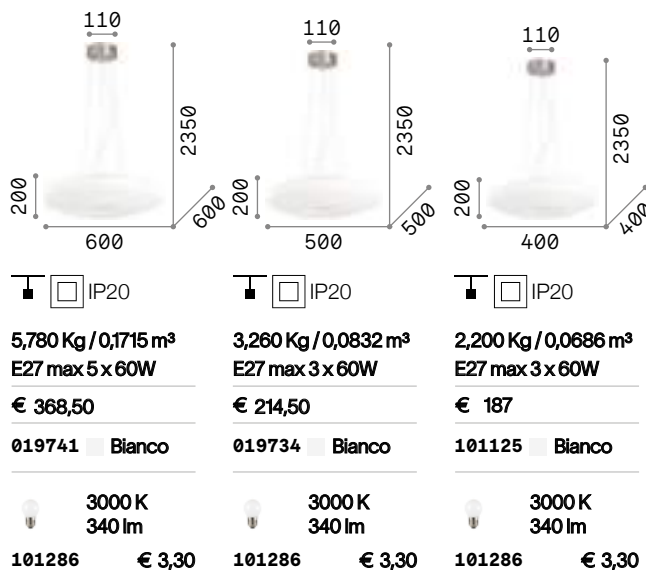

P. 278

Ulisse

Montatura in metallo verniciato bianco opaco. Diffusore in vetro bianco soffiato e acidato. Sospensioni con cavi in acciaio a lunghezza regolabile da dispositivi automatici.

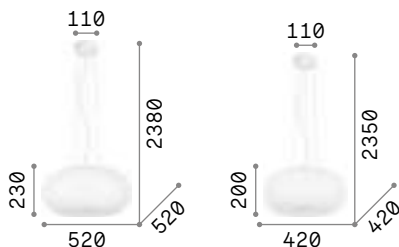

IP20

5,010 Kg / 0,1177 m³
E27 max 3 x 60W

€ 294,80

098616 Bianco

3000 K
910 lm

119571 € 7,70

IP20

3,110 Kg / 0,0720 m³
E27 max 3 x 60W

€ 217,80

095226 Bianco

3000 K
910 lm

119571 € 7,70



Arizona

Montatura in metallo rifinito in ottone satinato. Diffusore in vetro bianco soffiato, acidato e con rigature decorative in rilievo.

LED Lampadine LED GX53 9W 3000 K incluse. Cod. **123936**

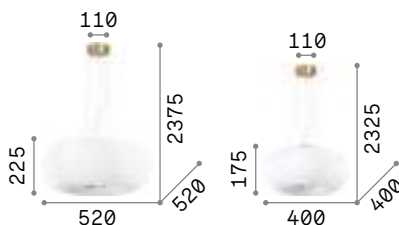

IP20

6,190 Kg / 0,1288 m³
GX53 max 5 x 15W

€ 511,50

214481 Bianco

3000 K
910 lm

123936 € 7,15

IP20

3,260 Kg / 0,0740 m³
GX53 max 3 x 15W

€ 379,50

214474 Bianco

3000 K
910 lm

123936 € 7,15



P. 280





Candy

Montatura in metallo con finitura nickel satinato. Diffusore in vetro bianco soffiato e acidato. Cavi in acciaio a lunghezza regolabile con dispositivi ferma cavo automatici.

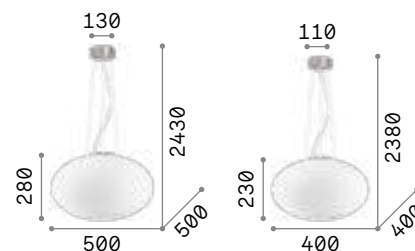

IP20

4,200 Kg / 0,1547 m³
E27 max 1x60W

€ 345,40

086743 Bianco

IP20

3,100 Kg / 0,0778 m³
E27 max 1x60W

€ 205,70

086736 Bianco



P. 281



P. 440

3000 K
900 lm

123899 € 7,70

3000 K
900 lm

123899 € 7,70

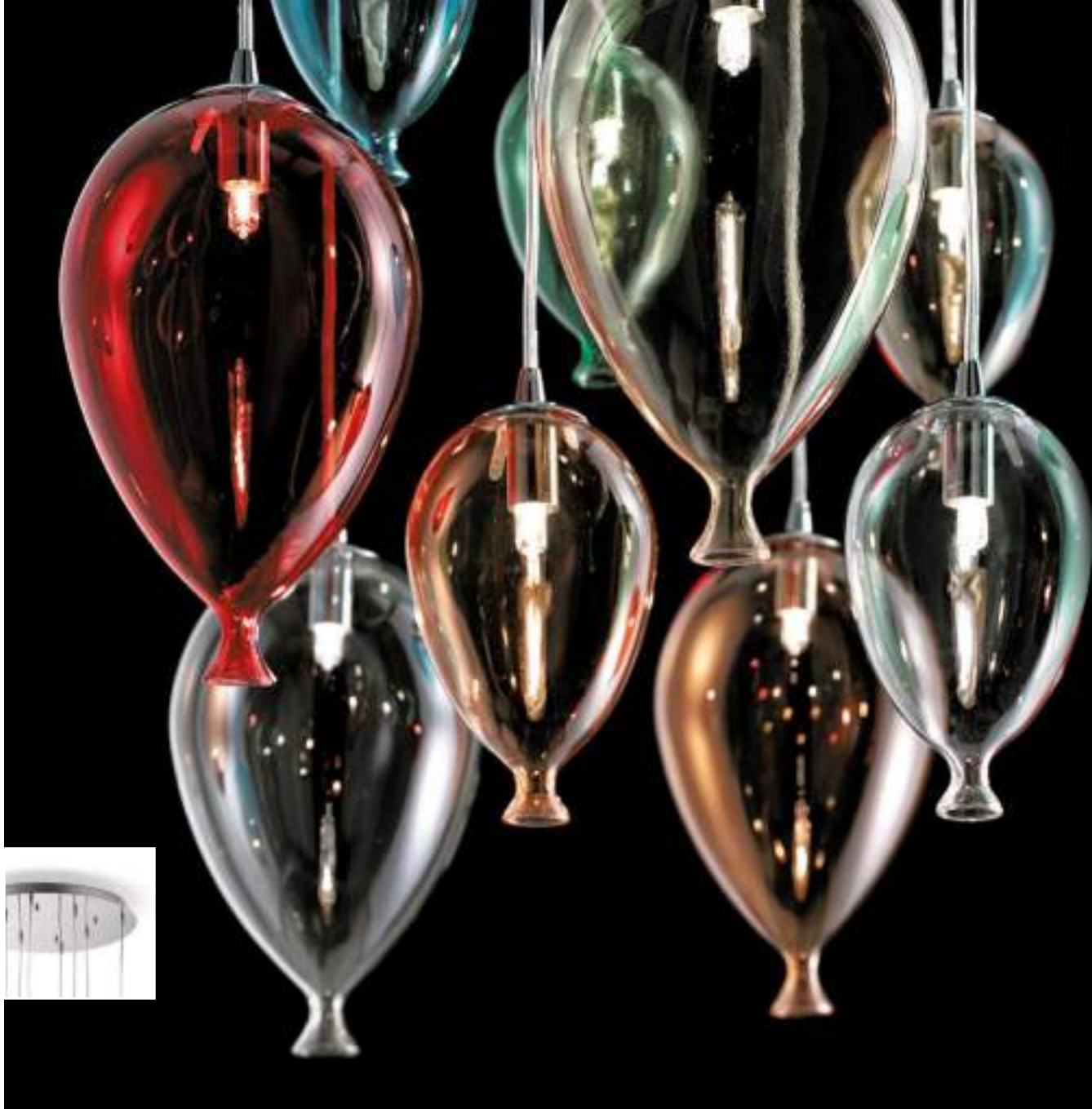

Clown

Montatura in metallo con diffusori in vetro soffiato e modellato a mano. Disponibile con montatura in cromo e vetri multicolor o cromati o con montatura e vetri bianchi.

LED

Lampadine LED G9 3W 3000 K incluse.
Cod. **209043**



100944



100883



100913

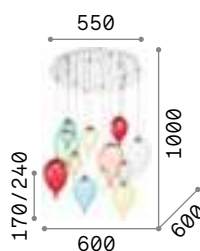

6,000 Kg / 0,1860 m³
G9 max 12 x 28W

€ 742,50

100951 Color

3000 K
370 lm

209043 € 4,29

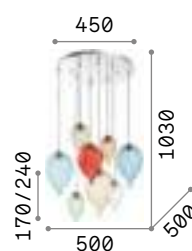

5,700 Kg / 0,1442 m³
G9 max 8 x 28W

€ 511,50

100944 Color
100883 Bianco
100913 Cromo

3000 K
370 lm

209043 € 4,29

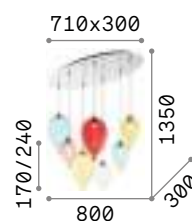

5,000 Kg / 0,1283 m³
G9 max 7 x 28W

€ 467,50

100937 Color

3000 K
370 lm

209043 € 4,29

Bollicine

Elementi decorativi con bolle di vetro soffiato. Disponibile con bolle trasparenti e bianche o trasparenti e cromo.

LED Lampadine LED G9 3W 3000 K incluse.
Cod. **209043**

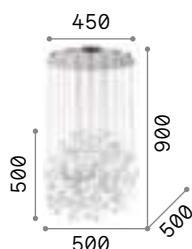

9,500 Kg / 0,2076 m³
G9 max 14 x 40W

€ 1210

087924 Bianco
093024 Cromo

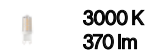

209043 € 4,29



087924



093024



Mapa Plus

Montatura in metallo. Diffusore a sfera in vetro bianco soffiato e acidato. Cavi in acciaio a lunghezza regolabile.

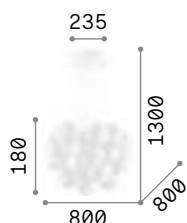

10,800 Kg / 0,1976 m³
E14 max 22 x 40W

€ 671

140230 Bianco

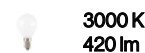

101217 € 3,30

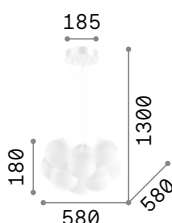

5,520 Kg / 0,1205 m³
E14 max 11 x 40W

€ 396

131924 Bianco

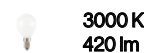

101217 € 3,30





Luce Max

Montatura in cromo. Diffusore in vetro soffiato con decorazione interna in filo d'alluminio. Sospensioni con cavo in acciaio a lunghezza regolabile da dispositivo ferma cavo automatico.

4,150 Kg / 0,0851 m³ E27 max 4 x 60W	2,150 Kg / 0,0458 m³ E27 max 3 x 60W	2,460 Kg / 0,0732 m³ E27 max 1 x 60W	1,500 Kg / 0,0334 m³ E27 max 1 x 60W
€ 248,60	€ 200,20	€ 119,90	€ 83,60
047799 Trasparen.	081762 Trasparen.	033662 Trasparen.	033679 Trasparen.
3000 K 910 lm	3000 K 910 lm	3000 K 910 lm	3000 K 910 lm
119571 € 7,70	119571 € 7,70	119571 € 7,70	119571 € 7,70

Mapa Sat

Montatura in metallo con finitura nickel o ottone. Diffusore in vetro soffiato trasparente con decoro interno in filo d'alluminio.

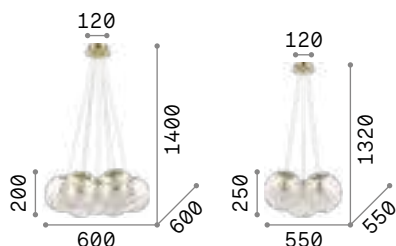

IP20

6,550 Kg / 0,1862 m³
E27 max 7x60W

€ 519,20

176062 Nickel
176000 Ottone

3000 K
910 lm

119571 € 7,70

IP20

2,700 Kg / 0,1210 m³
E27 max 3x60W

€ 293,70

176031 Nickel
175973 Ottone

3000 K
910 lm

119571 € 7,70



Mapa Max

Montatura in cromo. Diffusore in vetro soffiato con decorazione interna in filo d'alluminio. Sospensioni con cavo in acciaio a lunghezza regolabile da dispositivo ferma cavo automatico.

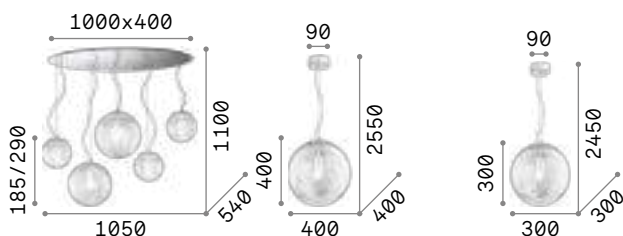

IP20

8,700 Kg / 0,2456 m³
E27 max 5x60W

€ 539

091112 Cromo

3000 K
910 lm

119571 € 7,70

IP20

3,450 Kg / 0,1370 m³
E27 max 1x60W

€ 165

045122 Cromo

3000 K
910 lm

119571 € 7,70

IP20

1,370 Kg / 0,0527 m³
E27 max 1x60W

€ 117,70

045115 Cromo

3000 K
910 lm

119571 € 7,70





Mapa Fade

Rosone e montatura in metallo cromato. Diffusore a sfera in vetro soffiato trasparente rifinito con cromatura sfumata verso il basso. Cavo in pvc trasparente. Colore: cromo.

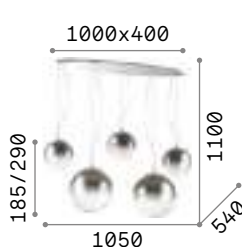

IP20

8,700 Kg / 0,2470 m³
E27 max 5x60W

€ 638

140759 ■ CromoStim.

3000 K
910 lm

119571 € 7,70

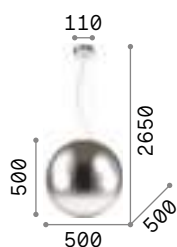

IP20

5,390 Kg / 0,2254 m³
E27 max 1x60W

€ 478,50

161327 ■ CromoStim.

3000 K
910 lm

119571 € 7,70

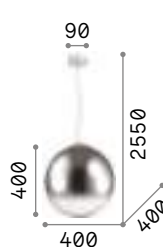

IP20

3,620 Kg / 0,1215 m³
E27 max 1x60W

€ 269,50

161334 ■ CromoStim.

3000 K
910 lm

119571 € 7,70

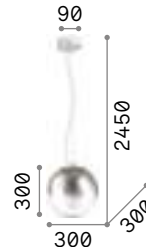

IP20

1,920 Kg / 0,0630 m³
E27 max 1x60W

€ 165

140728 ■ CromoStim.

3000 K
910 lm

119571 € 7,70

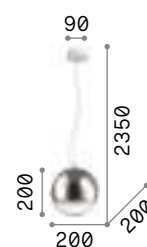

IP20

1,130 Kg / 0,0272 m³
E27 max 1x60W

€ 93,50

140711 ■ CromoStim.

3000 K
910 lm

119571 € 7,70



Mapa Bianco

Montatura in metallo bianco.
Diffusore a sfera in vetro soffiato e acidato. Cavi in acciaio a lunghezza regolabile.



8,700 Kg / 0,2470 m ³ E27 max 5x60W	5,390 Kg / 0,2254 m ³ E27 max 1x60W	3,620 Kg / 0,1215 m ³ E27 max 1x60W	1,920 Kg / 0,0630 m ³ E27 max 1x60W	1,130 Kg / 0,0272 m ³ E27 max 1x60W
€ 528	€ 302,50	€ 145,20	€ 78,10	€ 51,70
043562 Bianco	032122 Bianco	032139 Bianco	009087 Bianco	009148 Bianco
3000 K 910 lm	3000 K 910 lm	3000 K 910 lm	3000 K 910 lm	3000 K 910 lm
P. 280 P. 360 P. 441 119571 € 7,70	119571 € 7,70	119571 € 7,70	119571 € 7,70	119571 € 7,70



Carta new

Montatura in metallo verniciato bianco opaco. Diffusore in policarbonato con rivestimento ad effetto carta. Cavo rivestito in tessuto.

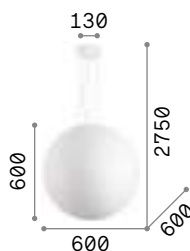
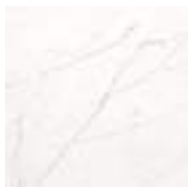

IP20

2,750 Kg / 0,2746 m³
E27 max 1x 60W

€ 456,50

272139 Bianco new

3000 K
2180 lm

151786 € 8,80

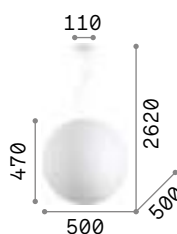

IP20

1,780 Kg / 0,1662 m³
E27 max 1x 25W

€ 335,50

226040 Bianco

3000 K
950 lm

101330 € 8,80

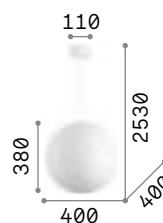

IP20

1,460 Kg / 0,0911 m³
E27 max 1x 25W

€ 209

226033 Bianco

3000 K
950 lm

101330 € 8,80

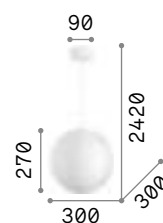

IP20

0,860 Kg / 0,0428 m³
E27 max 1x 25W

€ 104,50

226026 Bianco

3000 K
950 lm

101330 € 8,80

Boa

Montatura in metallo verniciato opaco bianco o nero. Cavo in tessuto da 12 metri con 6 supporti. Diffusore in vetro soffiato bianco acidato.

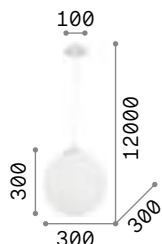

IP20

2,900 Kg / 0,0726 m³

E27 max 1x60W

€ 148,50

160863 Bianco

160856 Nero

3000 K
900 lm

123899 € 7,70



160863

160856



Mapa Riga

Montatura in metallo bianco. Diffusore a sfera in vetro soffiato bianco con decorazione dipinta. Cavi in acciaio a lunghezza regolabile.

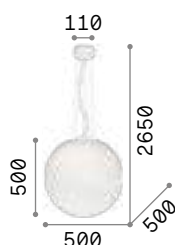

IP20

5,390 Kg / 0,2254 m³

E27 max 1x60W

€ 368,50

161365 Bianco

3000 K
910 lm

119571 € 7,70

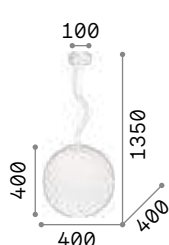

IP20

3,620 Kg / 0,1215 m³

E27 max 1x60W

€ 258,50

161372 Bianco

3000 K
910 lm

119571 € 7,70

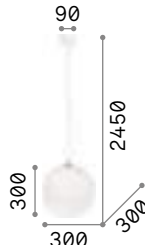

IP20

1,920 Kg / 0,0630 m³

E27 max 1x60W

€ 137,50

161389 Bianco

3000 K
910 lm

119571 € 7,70



Grape

Montatura in metallo rifinito ottone satinato. Cavi rivestiti in tessuto. Diffusore in vetro soffiato bianco con striature satinate.

LED Lampadine LED G9 3W 3000 K incluse nel modello **241340**. Cod. **209043**

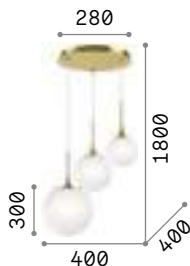

3,300 Kg / 0,0639 m³
G9 max 3x28W

€ 275

241340 ■ Bianco

3000 K
370 lm
209043 **€ 4,29**



3,080 Kg / 0,1303 m³
E27 max 1x60W

€ 225,50

241364 ■ Bianco

3000 K
900 lm
123899 **€ 7,70**



2,500 Kg / 0,0693 m³
E27 max 1x60W

€ 159,50

241357 ■ Bianco

3000 K
900 lm
123899 **€ 7,70**

Loko

Montatura in metallo con finitura ottone satinato. Diffusore in vetro incamiciato bianco, soffiato e acidato.

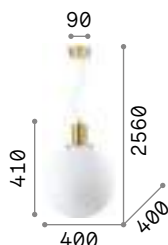

2,970 Kg / 0,1290 m³
E27 max 1x60W

€ 247,50

197920 ■ Bianco

3000 K
900 lm
123899 **€ 7,70**





Nemo Plus

Montatura in cromo. Diffusore in vetro soffiato con finitura in cromo sfumato. Cavi in acciaio a lunghezza regolabile da dispositivo ferma cavo automatico.

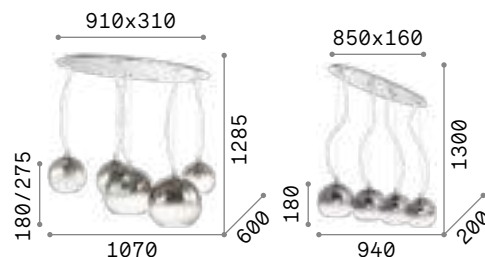

IP20

8,700 Kg / 0,2424 m³
E27 max 5 x 60W

€ 734,80

138305 CromoStum.

3000 K
910 lm

119571 € 7,70

IP20

4,500 Kg / 0,0873 m³
E27 max 4 x 60W

€ 415,80

149561 CromoStum.

3000 K
910 lm

119571 € 7,70



Nemo

Diffusore in vetro soffiato.
Disponibile in versione fumé,
trasparente, rame o cromo
sfumato. Modello 052793 con copri
lampada in vetro bianco soffiato e
acidato.

LED Lampadine LED G9 3W 3000 K incluse
nel modello **052793**. Cod. **209043**



052809 **149592** **094236** **250335** **111902**

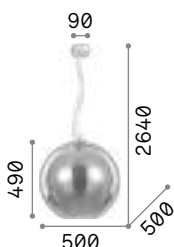

4,000 Kg / 0,2220 m³
E27 max 1x60W

€ 429

094137 **Fumè**

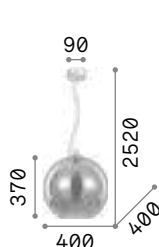

3,490 Kg / 0,1227 m³
E27 max 1x60W

€ 269,50

052816 **Trasparen.**
250359 **Cromo Sfum.**
094229 **Fumè**
250342 **Cromo**
111919 **Rame**

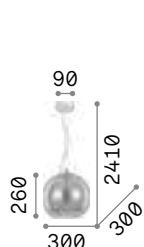

2,960 Kg / 0,0664 m³
E27 max 1x60W

€ 187

052809 **Trasparen.**
149592 **Cromo Sfum.**
094236 **Fumè**
250335 **Cromo**
111902 **Rame**

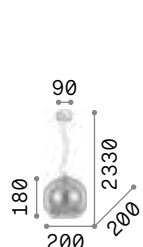

1,300 Kg / 0,0241 m³
E27 max 1x60W

€ 93,50

149585 **Cromo Sfum.**
250311 **Fumè**
250304 **Cromo**
250328 **Rame**

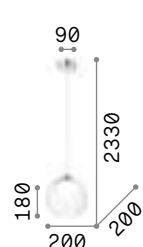

1,080 Kg / 0,0241 m³
G9 max 1x40W

€ 93,50

052793 **Trasparen.**

3000 K
1020 lm
101347 € 9,35

3000 K
1020 lm
101347 € 9,35

3000 K
1120 lm
101323 € 8,25

3000 K
1120 lm
101323 € 8,25

3000 K
370 lm
209043 € 4,29



Dna

Rosone e montatura in metallo dorato. Diffusori in vetro incamiciato bianco, soffiato e acidato. Cavi d'acciaio regolabili.

LED Lampadine LED G9 3W 3000 K incluse.
Cod. **209043**

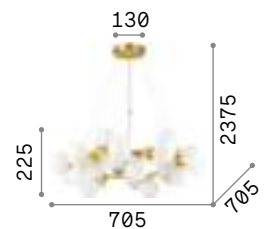

IP20

4,930 Kg / 0,2034 m³
G9 max 25 x 15W

€ 1100

208398 **Bianco**

3000 K
370 lm

209043 **€ 4,29**



Nodi

Montatura in metallo cromato oppure in ottone satinato. Diffusori in vetro bianco soffiato, acidato o trasparente e cromato.



082073



200491



241012



P. 306



P. 396

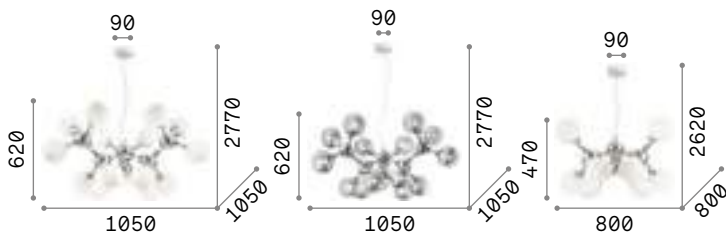

8,000 Kg / 0,4651 m³
E14 max 15 x 40W

€ 610,50

082073 ■ Bianco
241012 ■ OttoneSat.

3000 K
480 lm

101200 € 3,30



8,000 Kg / 0,4651 m³
E14 max 15 x 40W

€ 786,50

200491 ■ Cromo

3000 K
480 lm

101200 € 3,30



5,300 Kg / 0,1479 m³
E14 max 9 x 40W

€ 423,50

082059 ■ Bianco
241036 ■ OttoneSat.

3000 K
480 lm

101200 € 3,30



Ovalino

Diffusore composto da elementi circolari in lastra di vetro curvata e acidata. Cavi in acciaio regolabili in lunghezza da dispositivi automatici.

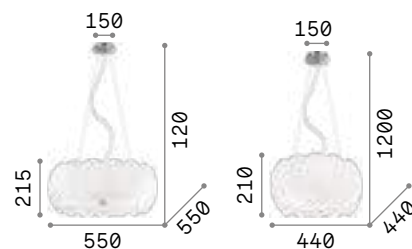

IP20

6,700 Kg / 0,1448 m³
E27 max 8 x 60W

€ 319

090481 Bianco

3000 K
900 lm

123899 € 7,70

IP20

4,810 Kg / 0,1184 m³
E27 max 5 x 60W

€ 250,80

074139 Bianco

3000 K
900 lm

123899 € 7,70



P. 282

P. 358

Basket

Montatura in metallo cromato.
Diffusore in spago ignifugo.
Sospensione a sfera con cavo in acciaio regolabile in lunghezza da dispositivo automatico.



0,800 Kg / 0,0911 m³
E27 max 1x60W

0,500 Kg / 0,0429 m³
E27 max 1x60W

€ 143

€ 99

096162 Bianco

096100 Bianco

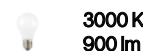

123899 € 7,70

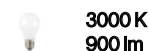

123899 € 7,70

Tokyo

Montatura in metallo cromato regolabile in altezza. Diffusori in vetro soffiato bianco incamiciato e acidato.

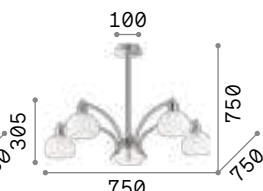
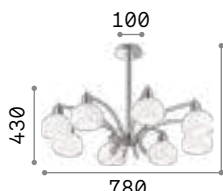

5,200 Kg / 0,1519 m³
E14 max 8 x 40W

3,600 Kg / 0,1386 m³
E14 max 5 x 40W

€ 346,50

€ 275

068466 Cromo

068459 Cromo

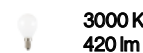

101217 € 3,30

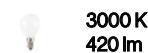

101217 € 3,30





Dream Big

Rosone in metallo verniciato bianco opaco. Cavo in tessuto. Diffusore in vetro soffiato bianco acidato. Cesto in corda.

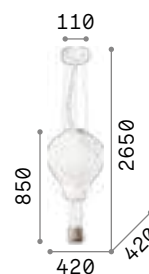

IP20

3,830 Kg / 0,1676 m³
E27 max 1x 42W

€ 258,50

261195 Bianco

3000 K
900 lm

123899 € 7,70

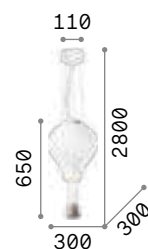

IP20

2,420 Kg / 0,1013 m³
E27 max 1x 42W

€ 148,50

179858 Bianco

3000 K
900 lm

123899 € 7,70

Avion

Corpo luce e rosone in legno dipinto con vernice opaca. Dettagli in metallo cromato. Diffusori in vetro soffiato bianco acidato.

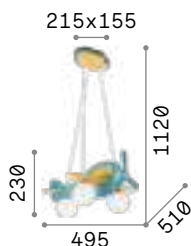

⚡ IP20

2,440 Kg / 0,0618 m³
E14 max 3x 40W

€ 181,50

136325 ■ Azzurro
136318 ■ Rosso

💡 3000 K
420 lm

101217 € 3,30



Multiflex

Montatura in metallo rifinito con vernice opaca. Bracci flessibili rivestiti di gomma. Cavo in acciaio regolabile in lunghezza da dispositivo automatico.

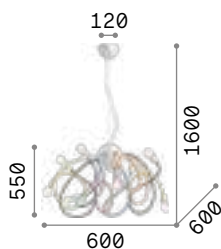

⚡ IP20

4,440 Kg / 0,0656 m³
E14 max 8x 40W

€ 396

141893 ■ Bianco
141909 ■ Color

💡 3000 K
420 lm

101217 € 3,30



141893



141909



P. 311





Soft

Montatura in metallo con finiture bianco e cromo. Diffusori in vetro soffiato bianco o fumè.



087818



111841

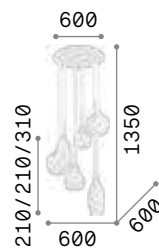

IP20

6,400 Kg / 0,1138 m³
E14 max 6 x 40W

€ 374

087818 ■ Bianco
111841 ■ Fumè

3000 K
420 lm

101217 € 3,30

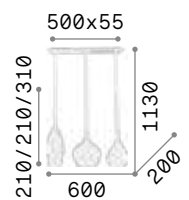

IP20

3,000 Kg / 0,0657 m³
E14 max 3 x 40W

€ 214,50

111858 ■ Bianco
111865 ■ Fumè

3000 K
420 lm

101217 € 3,30



Lido

Montatura in metallo cromato. Cavo in tessuto. Diffusori in vetro soffiato trasparente fumè.

LED

Lampadine LED G9 3W 3000 K incluse.
Cod. **209043**

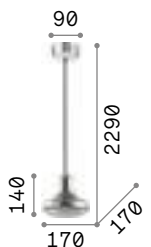

0,790 Kg / 0,0180 m³
G9 max 1x 15W

€ 77

168326 ■ Fumè

3000 K
370 lm
209043 € 4,29

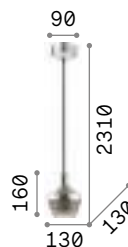

0,790 Kg / 0,0156 m³
G9 max 1x 15W

€ 77

168357 ■ Fumè

3000 K
370 lm
209043 € 4,29

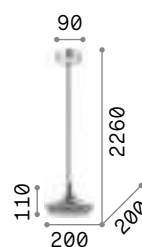

0,660 Kg / 0,0243 m³
G9 max 1x 15W

€ 88

168364 ■ Fumè

3000 K
370 lm
209043 € 4,29

Ken

Montatura in metallo cromato.
Diffusore in vetro soffiato. Cavi in acciaio a lunghezza regolabile con dispositivi ferma cavo automatici.

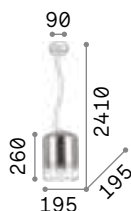
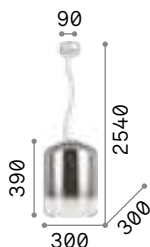

3,050 Kg / 0,0862 m³
E27 max 1x60W

1,520 Kg / 0,0309 m³
E27 max 1x60W

€ 313,50

€ 203,50

112107 ■ CromoStum.

112084 ■ CromoStum.

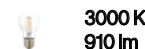
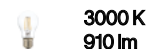

119571 € 7,70

119571 € 7,70



Zeno

Montatura in metallo cromato.
Diffusore in vetro soffiato trasparente e colorato. Cavo elettrico regolabile in lunghezza.

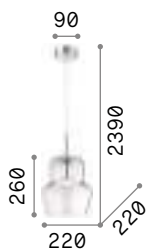

1,370 Kg / 0,0231 m³
E27 max 1x60W

€ 115,50

088921 ■ Trasparen.

088938 ■ Fumè

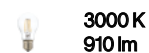

119571 € 7,70



088921

088938



Coco **new**

Montatura in metallo verniciato a polveri con finitura nera. Diffusore in acrilico trasparente con bordo laterale satinato. Vetro soffiato trasparente con finitura fumè. Cavo in pvc.

LED Sorgente luminosa LED 3000 K, 20.000 h di durata.

IP20	IP20	IP20
1,200 Kg / 0,0128 m ³ LED 7W / 660 lm	1,140 Kg / 0,0132 m ³ LED 7W / 660 lm	1,080 Kg / 0,0152 m ³ LED 7W / 660 lm
€ 148,50	€ 148,50	€ 148,50
275567 ■ Fumè	new 275581 ■ Fumè	new 275543 ■ Fumè new



Mint

Montatura in metallo con finitura ottone satinato e rosone nero opaco. Cavo rivestito in tessuto. Diffusore in vetro soffiato con rigatura in rilievo. Disponibile nelle finiture fumè o verde.



237510



237497

IP20	IP20	IP20
1,350 Kg / 0,0147 m³ E27 max 1x 60W	1,560 Kg / 0,0532 m³ E27 max 1x 60W	1,80 Kg / 0,0269 m³ E27 max 1x 60W
€ 104,50	€ 126,50	€ 137,50
237442 Fumè 248554 Verde	237398 Fumè 237428 Verde	237510 Fumè 237497 Verde
3000 K 910 lm	3000 K 910 lm	3000 K 910 lm
119571 € 7,70	119571 € 7,70	119571 € 7,70



Bergen

Rosone in metallo verniciato a polveri di colore nero. Montatura in legno naturale. Diffusore in vetro soffiato trasparente con motivo decorativo in rilievo e finitura fumè. Cavo rivestito in tessuto.

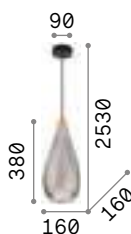
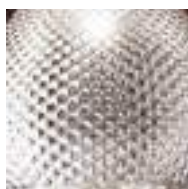

1,570 Kg / 0,0331 m³
E27 max 1x60W

€ 181,50

238838 ■ Fumè

3000 K
910 lm
119571 € 7,70



1,840 Kg / 0,0439 m³
E27 max 1x60W

€ 181,50

238920 ■ Fumè

3000 K
910 lm
119571 € 7,70

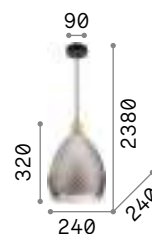

1,430 Kg / 0,0378 m³
E27 max 1x60W

€ 181,50

238746 ■ Fumè

3000 K
910 lm
119571 € 7,70



Bistrò

Montatura in metallo verniciato nero. Diffusore in vetro, ambra, trasparente o fumè, soffiato e modellato artigianalmente.



112305



112312



163789

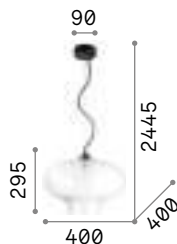

IP20

2,190 Kg / 0,0806 m³
E27 max 1x60W

€ 205,70

120898 Trasparen.
120904 Fumè

3000 K
910 lm

119571 € 7,70

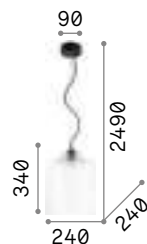

IP20

1,840 Kg / 0,0427 m³
E27 max 1x60W

€ 139,70

112305 Trasparen.
112312 Fumè
163789 Ambra

3000 K
910 lm

119571 € 7,70

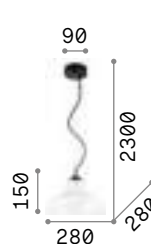

IP20

1,200 Kg / 0,0274 m³
E27 max 1x60W

€ 107,80

112336 Trasparen.
112343 Fumè

3000 K
910 lm

119571 € 7,70



Gretel

Montatura in metallo rifinito in vernice nera opaca con applicazione in legno naturale. Diffusori in vetro soffiato trasparente. Cavi in tessuto nero.

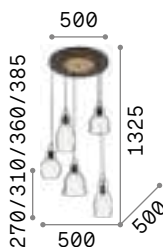

IP20

5,960 Kg / 0,1419 m³
E27 max 5x60W

€ 492,80

103174 ■ Nero

3000 K
910 lm
119571 € 7,70

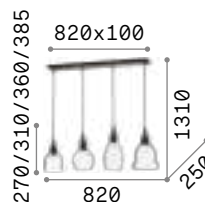

IP20

4,090 Kg / 0,0983 m³
E27 max 4x60W

€ 404,80

122557 ■ Nero

3000 K
910 lm
119571 € 7,70

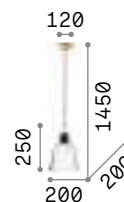

IP20

0,950 Kg / 0,0243 m³
E27 max 1x60W

€ 104,50

122564 ■ Nero

3000 K
910 lm
119571 € 7,70

Audi-61

Montatura in metallo cromato.
Catene di ottagononi in cristallo.
Diffusore in vetro soffiato.
Sospensioni con cavi in acciaio a
lunghezza regolabile da dispositivi
automatici.

LED Lampadine LED G9 3W 3000 K incluse.
Cod. **209043**

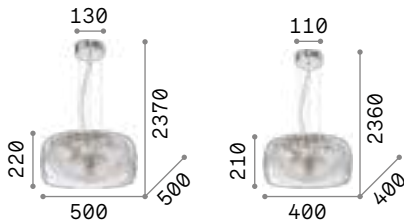

7,790 Kg / 0,1170 m³
G9 max 8 x 40W

€ 550

133881 Cromo

4,570 Kg / 0,0783 m³
G9 max 6 x 40W

€ 357,50

133874 Cromo

3000 K
370 lm
209043 € 4,29

3000 K
370 lm
209043 € 4,29



Audi-10

Montatura in metallo cromato.
Diffusore in vetro soffiato
trasparente o fumè. Cavi in
acciaio a lunghezza regolabile con
dispositivi ferma cavo automatici.

LED Lampadine LED E27 8W Globo D95
3000 K incluse. Cod. **101330/101323**

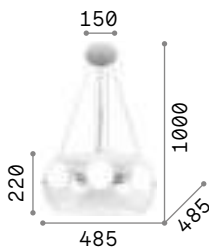

5,520 Kg / 0,1044 m³
E27 max 5 x 60W

€ 412,50

016863 Trasparen.
103983 Fumè

3000 K
950 lm
101330 € 8,80



016863

103983





Audi-80

Montatura in metallo cromato.
Elementi decorativi con sfere di vetro
su fili di metallo. Diffusore in vetro
soffiato trasparente o fumé. Cavi in
acciaio a lunghezza regolabile con
ferma cavo automatici.



031743



197661

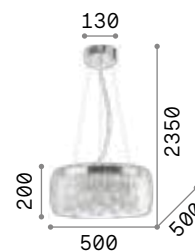

9,560 Kg / 0,1289 m³
G9 max 8 x 40W

€ 605

031750 Trasparen.
197654 Fumé

3000 K
370 lm

209043 € 4,29

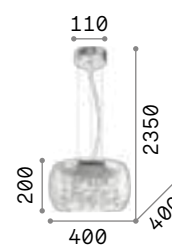

5,890 Kg / 0,0876 m³
G9 max 5 x 40W

€ 412,50

031743 Trasparen.
197661 Fumé

3000 K
370 lm

209043 € 4,29

LED Lampadine LED G9 3W 3000 K incluse.
Cod. 209043



Madame

Rosone in metallo verniciato opaco bianco o nero. Cavo in tessuto. Diffusore con telaio metallico avvolto da nastro in tessuto di raso bianco, canvas o nero.

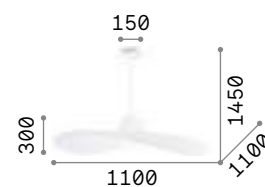

IP20

2,560 Kg / 0,2012 m³
E27 max 1x60W

€ 385

174396 ■ Bianco
219875 ■ Avorio
174402 ■ Nero



174396



219875



174402

3000 K
900 lm

101354 € 9,35



Phoenix

Montatura in metallo cromato. Paralume con telaio in metallo e rivestimento in tessuto. Elementi decorativi con catene di ottagononi in cristallo molato. Sospensioni con cavi in acciaio regolabili in lunghezza da dispositivi automatici.



099101



101163

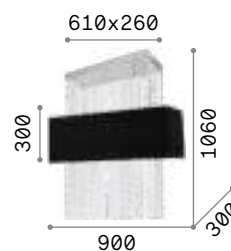

IP20

8,400 Kg / 0,1030 m³
E27 max 5 x 60W

€ 825

099101 ■ Bianco
101163 ■ Nero

3000 K
900 lm

123899 € 7,70

London

Montatura in metallo cromato.
Paralume in lamina di PVC
cromata e semi trasparente. Per
la sospensione, cavi in acciaio a
lunghezza regolabile con dispositivi
ferma cavo automatici.

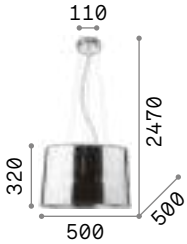

2,950 Kg / 0,1055 m³
E27 max 5 x 60W

€ 225,50

032351 Cromo

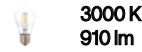

119571 € 7,70



P. 449

P. 495



Nordik

Montatura in metallo verniciato
nero opaco. Paralume in lamina
di PVC dorato rivestito in tessuto
nero.



1,760 Kg / 0,1694 m³
E27 max 6 x 60W

€ 275

161662 Nero

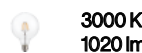

101347 € 9,35

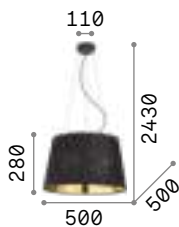

1,500 Kg / 0,1064 m³
E27 max 4 x 60W

€ 209

161648 Nero

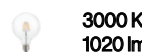

101347 € 9,35

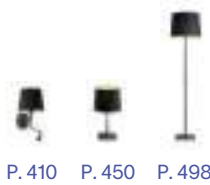

P. 410

P. 450

P. 498



Cylinder

Montatura in metallo. Diffusore in vetro soffiato bianco acidato. Cavi in acciaio a lunghezza regolabile con dispositivi ferma cavo automatici.

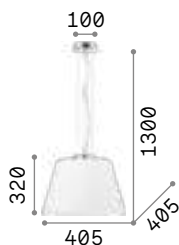

4,040 Kg / 0,0729 m³

E27 max 1x60W

€ 225,50

025438 Bianco

3000 K
900 lm

101354 € 9,35



P. 498



Cloe

Rosone e paralume in metallo verniciato a polveri o placcato. Diffusore in policarbonato opale. Cavo in pvc trasparente. Colori: bianco, nero o cromo spazzolato.

LED Sorgente luminosa LED 3000 K, 30.000 h di durata.

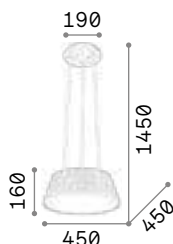

2,040 Kg / 0,0622 m³

LED 43W / 2900 lm

€ 313,50

247298 Bianco

269795 Cromo

247304 Nero



247298

269795

247304





Woody

Montatura in metallo cromato.
Diffusore in PVC o in tessuto,
chiuso sul fondo da vetro
trasparente acidato. Sospensioni
con cavi regolabili in lunghezza.



087719

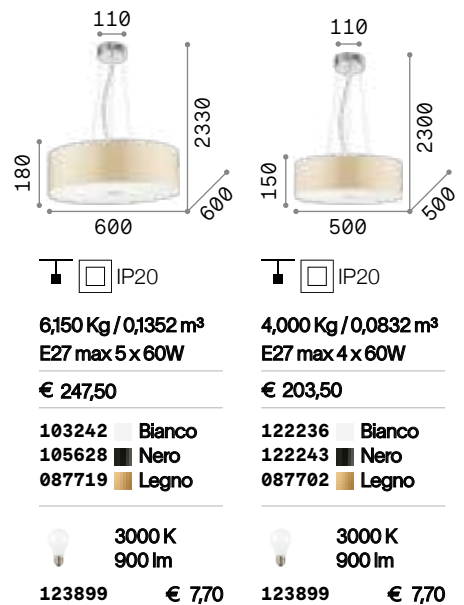



Hilton

Montatura in cromo. Paralume in lamina di PVC rivestita in tessuto. Sul fondo, diffusore in vetro trasparente sabbiato. Sospensioni con cavi a lunghezza regolabile.

LED Lampadine LED G9 3W 3000 K incluse nel modello **075495**. Cod. **209043**

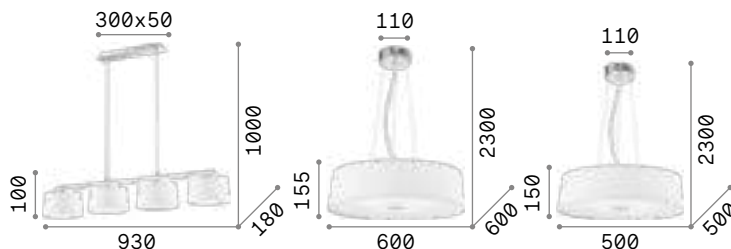

2,850 Kg / 0,0374 m³
G9 max 4x40W

€ 214,50

075495 Bianco

3000 K
370 lm

209043 € 4,29



5,980 Kg / 0,1183 m³
E27 max 6x60W

€ 253

075518 Bianco

3000 K
900 lm

123899 € 7,70



3,480 Kg / 0,0817 m³
E27 max 4x60W

€ 187

075501 Bianco

3000 K
900 lm

123899 € 7,70



P. 408

P. 451

P. 501



Wheel

Montatura circolare in metallo smaltato. Paralume in lamina di PVC rivestita di tessuto. Cavi in acciaio a lunghezza regolabile con dispositivi ferma cavo automatici.

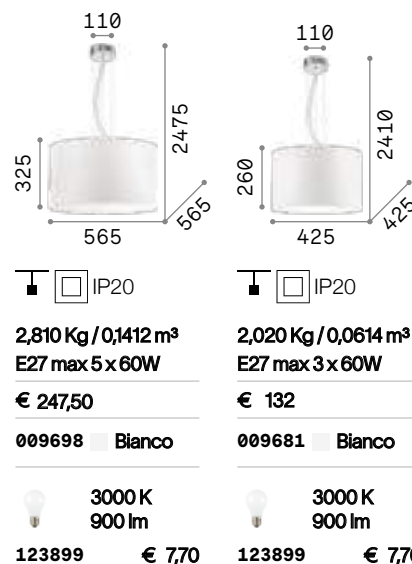

P. 285



Ekos

Montatura in metallo con finitura bianco opaco. Paralumi in lamina di PVC rivestita di tessuto canvas.

LED

Lampadine LED G9 3W 3000 K incluse.
Cod. **209043**

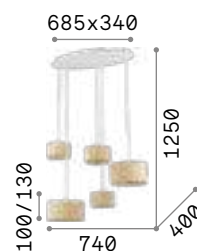

IP20

3,950 Kg / 0,0917 m³
G9 max 5 x 40W

€ 368,50

110868 Canvas

3000 K
370 lm

209043 € 4,29



P. 406

P. 456

P. 496

Set up

Montature in metallo verniciato a polveri o placcato. Paralumi in pvc ignifugo rivestito di tessuto. Colori montature: bianco, nero oppure nichel satinato o ottone spazzolato. Colori paralumi: beige, bianco o nero.



260013



260044



260020



260051

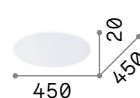
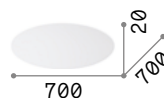
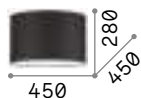
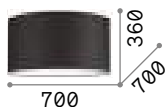

0,350 Kg / 0,0019 m³
E27 max 1x60W

€ 27,50

260013 Bianco
260044 Nickel
260020 Nero
260051 Ottone

1,260 Kg / 0,2131 m³

€ 115,50

260471 Bianco
270029 Nero
260488 Beige

0,047 Kg / 0,0768 m³

€ 82,50

260457 Bianco
270012 Nero
260464 Beige

0,700 Kg / 0,0259 m³

€ 55

270050 Trasparen.

0,280 Kg / 0,0108 m³

€ 33

270043 Trasparen.



3000 K
900 lm

123899

€ 7,70



Opera

Montatura in cromo. Paralume in lamina di PVC con riflessi metallizzati e rivestita da fili.
 Pendagli in cristallo molato.
 Sospensioni con cavi in acciaio a lunghezza regolabile.

IP20	IP20	IP20
7,340 Kg / 0,3322 m³ E27 max 10 x 60W	4,889 Kg / 0,1652 m³ E27 max 6 x 60W	3,166 Kg / 0,0646 m³ E27 max 4 x 60W
€ 836	€ 495	€ 363
165011 Bianco	068299 Bianco	182179 Bianco
3000 K 900 lm	3000 K 900 lm	3000 K 900 lm
123899 € 7,70	123899 € 7,70	123899 € 7,70

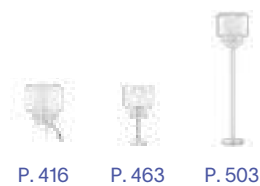

P. 416

P. 463

P. 503



Swan

Montatura in cromo. Corpo luce in vetro soffiato e lavorato a mano. Elementi decorativi in cristallo molato. Paralume in tessuto d'organza plissettato. Copricatena in velluto.



035840



208497

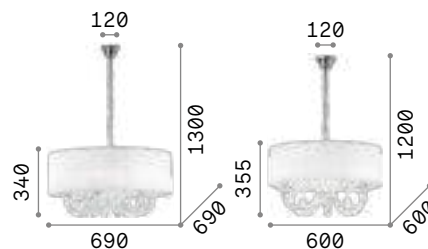

IP20

6,420 Kg / 0,2708 m³
E14 max 6 x 40W

€ 568,70

035826 ■ Bianco
208152 ■ Argento

IP20

4,770 Kg / 0,1632 m³
E14 max 3 x 40W

€ 394,90

035840 ■ Bianco
208497 ■ Argento

 3000 K
420 lm

101217 € 3,30

 3000 K
420 lm

101217 € 3,30



P. 416

Calypso

Montatura in metallo cromato.
Elementi decorativi in cristallo
molato. Sospensioni con cavi in
acciaio a lunghezza regolabile da
dispositivi ferma cavo automatici.

LED Lampadine LED G9 3W 3000 K incluse
nel modello **044187**. Cod. **209043**



IP20

6,410 Kg / 0,0893 m³
E27 max 5 x 60W

€ 671

044200 Cromo

3000 K
430 lm

101279 € 3,30



IP20

4,000 Kg / 0,0566 m³
E27 max 3 x 60W

€ 528

044194 Cromo

3000 K
430 lm

101279 € 3,30

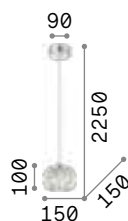

IP20

1,130 Kg / 0,0138 m³
G9 max 1 x 40W

€ 154

044187 Cromo

3000 K
370 lm

209043 € 4,29



P. 414

Orion

Diffusore composto da anelli in
metallo cromato con ottagononi di
cristallo incastonati all'interno.
Sospensioni con cavi in acciaio
regolabili in lunghezza da
dispositivi automatici.



IP20

10,100 Kg / 0,2435 m³
E14 max 12 x 40W

€ 935

066394 Cromo

3000 K
480 lm

101200 € 3,30



IP20

6,800 Kg / 0,1476 m³
E14 max 8 x 40W

€ 605

066387 Cromo

3000 K
480 lm

101200 € 3,30



IP20

4,600 Kg / 0,0875 m³
E14 max 6 x 40W

€ 440

059181 Cromo

3000 K
480 lm

101200 € 3,30



P. 321



King

Diffusore composto da anelli in metallo cromato o dorato con ottagoni di cristallo incastonati all'interno. Sospensioni con cavi in acciaio a lunghezza regolabile da dispositivi automatici.



088013



088020

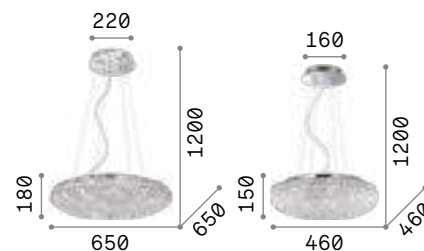

10,000 Kg / 0,1486 m³
G9 max 12 x 40W

€ 1045

088013 Cromo
088020 Oro

3000 K
370 lm

209043 € 4,29



5,300 Kg / 0,0748 m³
G9 max 7 x 40W

€ 660

087979 Cromo

3000 K
370 lm

209043 € 4,29



P. 320



Rain

Montatura in metallo cromato.
 Pendagli con elementi in cristallo
 molato in varie forme e gocce finali.
 Sospensioni con cavi in acciaio a
 lunghezza regolabile.



P. 330 P. 462

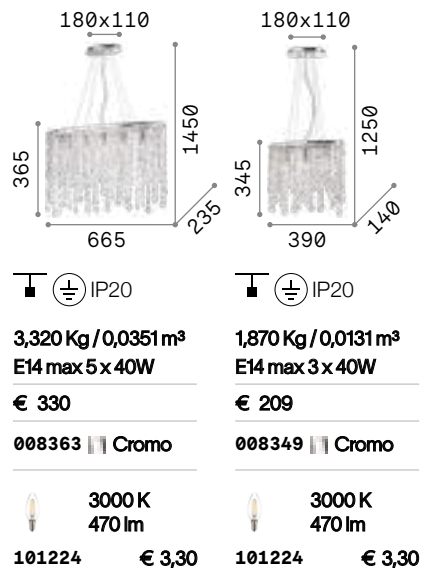



Giada

Montatura in metallo cromato.
Pendagli con elementi ottagonali
e puntali finali in cristallo molato.
Sospensioni con cavi in acciaio a
lunghezza regolabile.

LED

Lampadine LED G9 3W 3000 K incluse.
Cod. **209043**

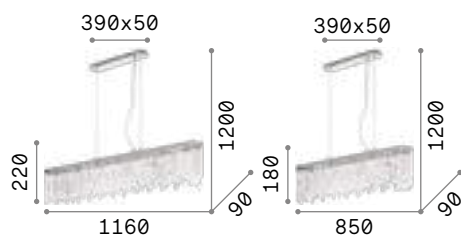

5,500 Kg / 0,0297 m³
G9 max 7 x 40W

€ 533,50

098739 Trasparen.

3000 K
370 lm

209043 € 4,29



4,000 Kg / 0,0217 m³
G9 max 5 x 40W

€ 396

098722 Trasparen.

3000 K
370 lm

209043 € 4,29



Elisir

Montatura in metallo. Elementi decorativi a prisma in cristallo molato trasparente nella versione cromo, ambra in quella ottone.

LED Lampadine LED G9 3W 3000 K incluse.
Cod. **209043**



200002



200071

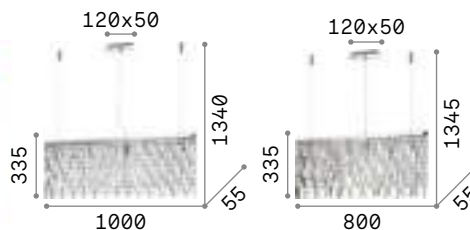

8,380 Kg / 0,0408 m³
G9 max 8 x 40W

€ 624,80

200002 Cromo
200071 Ottone

3000 K
370 lm

209043 € 4,29



6,370 Kg / 0,0325 m³
G9 max 6 x 40W

€ 544,50

199993 Cromo
200064 Ottone

3000 K
370 lm

209043 € 4,29



Martinez

Montatura in metallo cromato o dorato. Elementi decorativi con catene di ottagononi e barre in cristallo molato trasparente.



166360



213583

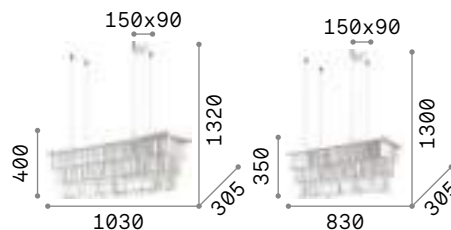

IP20

17,600 Kg / 0,1129 m³
E14 max 8 x 40W

€ 742,50

166360 Cromo
213583 Oro

IP20

14,490 Kg / 0,0723 m³
E14 max 6 x 40W

€ 632,50

166322 Cromo



P. 330

3000 K
470 lm

101224 € 3,30

3000 K
470 lm

101224 € 3,30



Carlton

Montatura in metallo cromato o dorato. Elementi decorativi con catene di ottagoni e barre in cristallo molato trasparente.



166247



213521

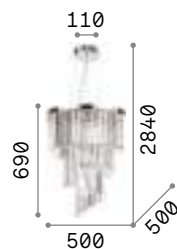

IP20

12,800 Kg / 0,1614 m³
E14 max 12 x 40W

€ 660

166247 Cromo
213521 Oro

3000 K
470 lm

101224 € 3,30

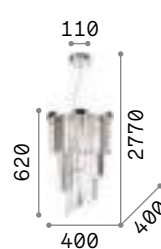

IP20

10,000 Kg / 0,1136 m³
E14 max 8 x 40W

€ 550

117737 Cromo

3000 K
470 lm

101224 € 3,30



P. 331



P. 415

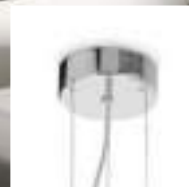

Roma

Montatura e dettagli in metallo cromato. Diffusore con elementi quadrati in cristallo molato sulla fascia laterale e vetro sabbato sul fondo. Sospensioni con cavi a lunghezza regolabile.

LED Lampadine LED G9 3W 3000 K incluse.
Cod. **209043**

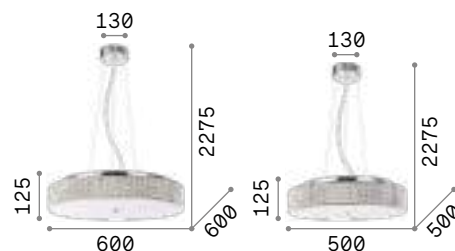

10,000 Kg / 0,1202 m³
G9 max 12 x 40W

7,100 Kg / 0,0890 m³
G9 max 9 x 40W

€ 797,50

€ 632,50

093062 || Cromo

093048 || Cromo

3000 K
370 lm

3000 K
370 lm

209043 € 4,29

209043 € 4,29



P. 318

P. 414

P. 462



Nabucco

Montatura in metallo con finitura oro. Elementi decorativi in cristallo trasparente molato. Quadrati nella parte superiore e a losanga in quella inferiore.

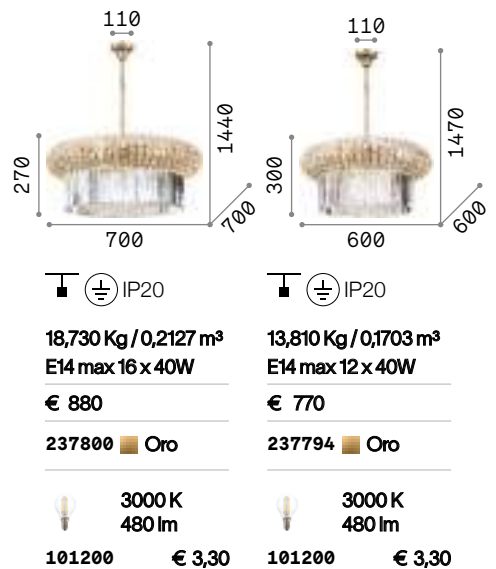



Pashà

Montatura in metallo. Diffusore composto da filari di perle in cristallo molato e fondo chiuso da vetro circolare sabbato. Cavi in acciaio a lunghezza regolabile con dispositivi fermacavo automatici.

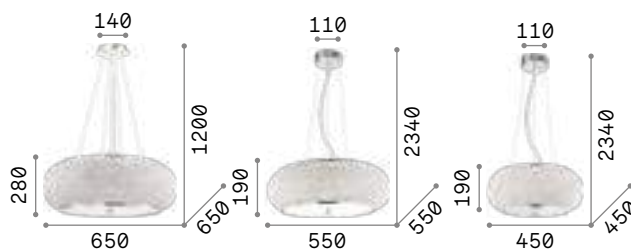

13,000 Kg / 0,1777 m³
E14 max 14 x 40W

€ 1210

164977 Cromo
164984 Oro

3000 K
480 lm

101200 € 3,30



8,500 Kg / 0,1007 m³
E14 max 10 x 40W

€ 946

082196 Cromo
082257 Oro

3000 K
480 lm

101200 € 3,30



5,350 Kg / 0,0573 m³
E14 max 6 x 40W

€ 731,50

082158 Cromo
082172 Oro

3000 K
480 lm

101200 € 3,30



164977



164984



P. 319



P. 414

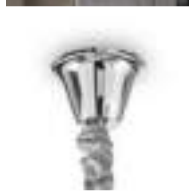

Luxor

Montatura in metallo cromato.
Diffusore con elementi decorativi
ottagonali e rettangolari in cristallo
molato. Copricatena in velluto.

LED Lampadine LED G9 3W 3000 K incluse.
Cod. **209043**



12,250 Kg / 0,3097 m³
G9 max 12 x 40W

€ 1320

116235 || Cromo

3000 K
370 lm

209043 € 4,29

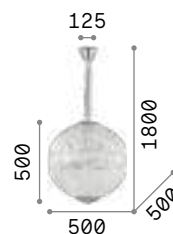

8,780 Kg / 0,2054 m³
G9 max 8 x 40W

€ 935

116228 || Cromo

3000 K
370 lm

209043 € 4,29

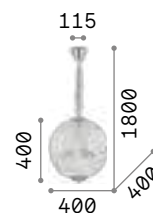

8,340 Kg / 0,1260 m³
G9 max 6 x 40W

€ 715

092911 || Cromo

3000 K
370 lm

209043 € 4,29

Evasione

Pendagli in cristallo molato.
Sospensioni con cavo in acciaio a
lunghezza regolabile da dispositivo
fermacavo automatico.

LED Lampadine LED G9 3W 3000 K incluse.
Cod. **209043**



7,100 Kg / 0,1082 m³
G9 max 10 x 40W

€ 563,20

044767 Cromo

3000 K
370 lm

209043 € 4,29



5,900 Kg / 0,0706 m³
G9 max 8 x 40W

€ 454,30

044774 Cromo

3000 K
370 lm

209043 € 4,29

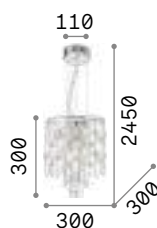

2,800 Kg / 0,0283 m³
G9 max 4 x 40W

€ 244,20

062211 Cromo

3000 K
370 lm

209043 € 4,29



Audi-77

Pendagli ottagonali e tondi in
cristallo molato. Sospensioni con
cavi a lunghezza regolabile da
dispositivi automatici.

LED Lampadine LED G9 3W 3000 K incluse.
Cod. **209043**

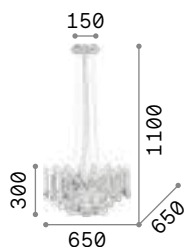

6,550 Kg / 0,1347 m³
G9 max 8 x 40W

€ 563,20

020556 Cromo

3000 K
370 lm

209043 € 4,29

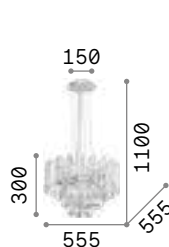

5,230 Kg / 0,1044 m³
G9 max 6 x 40W

€ 476,30

019499 Cromo

3000 K
370 lm

209043 € 4,29





Dubai

Montatura in metallo con finitura cromo o ottone. Elementi decorativi con perle, ottagoni e prismi in cristallo molato trasparente.



243597



243528



P. 329

P. 415

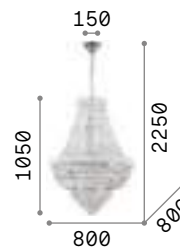

IP20

20,000 Kg / 0,7875 m³
E14 max 24 x 40W

€ 1650

243597 Cromo
243528 Ottone

3000 K
470 lm

101224 € 3,30

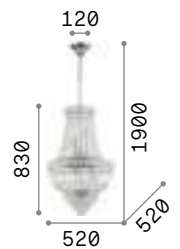

IP20

9,170 Kg / 0,2859 m³
E14 max 10 x 40W

€ 1045

215969 Cromo
207216 Ottone

3000 K
470 lm

101224 € 3,30



Caesar

Montatura in metallo con finitura in oro o cromo. Elementi decorativi in cristallo molato ottagonali con finali a puntale.



Lampadine alogene G9 28W
2700 K incluse.



114279



114743



P. 329



9,600 Kg / 0,2965 m³
G9 max 12 x 40W

€ 1210

114279 || Cromo
114743 || Oro

3000 K
370 lm

209043 € 4,29



6,700 Kg / 0,1936 m³
G9 max 9 x 40W

€ 907,50

041827 || Cromo
114736 || Oro

3000 K
370 lm

209043 € 4,29

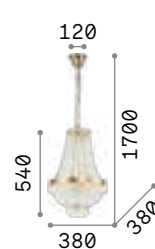

5,100 Kg / 0,1175 m³
G9 max 6 x 40W

€ 715

033532 || Cromo
114729 || Oro

3000 K
370 lm

209043 € 4,29



Millennium

Montatura e dettagli in metallo verniciato con effetto ruggine. Elementi decorativi centrali in legno naturale antichizzato.

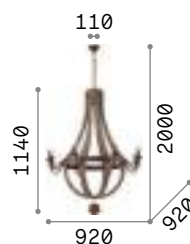

IP20

8,330 Kg / 1,0291 m³
E14 max 8 x 40W

€ 1192,40

129709 ■ Legno

3000 K
470 lm

101224 € 3,30

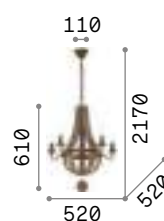

IP20

2,670 Kg / 0,2695 m³
E14 max 5 x 40W

€ 434,50

129921 ■ Legno

3000 K
470 lm

101224 € 3,30



Monet

Montatura in metallo con fasce circolari decorate a sbalzo. Catene con perle in legno naturale. Finitura con vernice opaca bianca.

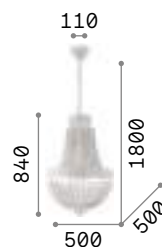

IP20

6,700 Kg / 0,0534 m³
E14 max 6 x 40W

€ 519,20

162751 Bianco

3000 K
420 lm

101217 € 3,30

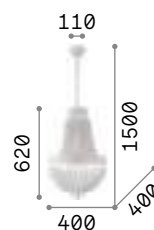

IP20

5,300 Kg / 0,0387 m³
E14 max 5 x 40W

€ 415,80

162737 Bianco

3000 K
420 lm

101217 € 3,30



Pegaso

Montatura in metallo cromato oppure ottone satinato. Corpo centrale, bobeches e pendagli in cristallo molato. Paralumi in organza. Copricatena in velluto.



059242



197739

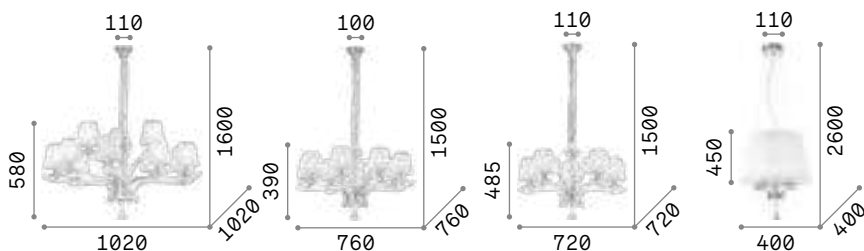

8,100 Kg / 0,3349 m³
E14 max 12 x 40W

€ 797,50

066431 Bianco
197746 OttoneSat.

3000 K
370 lm

101231 € 3,30



7,900 Kg / 0,2138 m³
E14 max 8 x 40W

€ 627

059242 Bianco
197739 OttoneSat.

3000 K
370 lm

101231 € 3,30



5,600 Kg / 0,1445 m³
E14 max 5 x 40W

€ 451

066448 Bianco
197722 OttoneSat.

3000 K
370 lm

101231 € 3,30



3,050 Kg / 0,0758 m³
E14 max 3 x 40W

€ 220

059235 Bianco
197715 OttoneSat.

3000 K
370 lm

101231 € 3,30



P. 417



P. 467



P. 504



Blanche

Montatura in metallo rifinito con smalto satinato bianco o nero. Paralumi in lamina di PVC rivestita di tessuto bianco o nero. Copricatena in velluto.

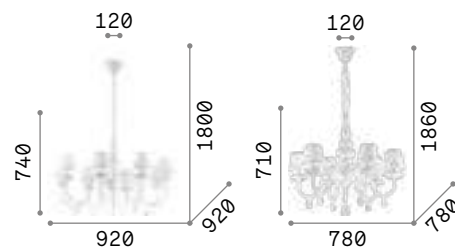

IP20

6,820 Kg / 0,1975 m³
E14 max 8 x 40W

€ 550

035574 ■ Bianco
111896 ■ Nero

3000 K
370 lm

101231 € 3,30

IP20

4,800 Kg / 0,1451 m³
E14 max 6 x 40W

€ 440

035581 ■ Bianco
111872 ■ Nero

3000 K
370 lm

101231 € 3,30



035581



111872

Pantheon

Montatura in metallo cromato o dorato. Elemento centrale con biglie in vetro. Pendagli e bobecche in vetro. Paralumi in vetro molato. Paralume di tessuto con decorazione in rilievo e brillantini. Copricatena in velluto.

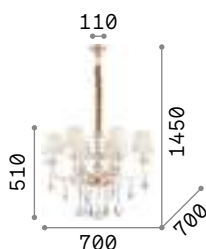

IP20

5,500 Kg / 0,0900 m³

E14 max 6 x 40W

€ 587,40

088051 Cromo

088068 Oro

3000 K
470 lm

101224 € 3,30



088051



088068

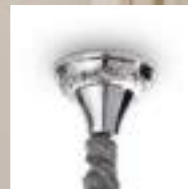

Provence

Corpo luce in legno tornito e bracci in metallo. Finitura con vernice opaca. Paralumi in lamina di PVC rivestita in tessuto a trama grossa.

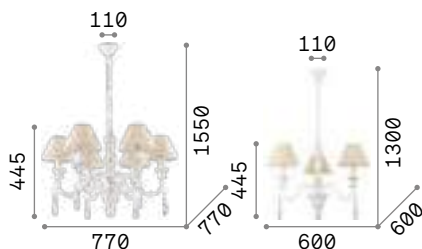

IP20

3,100 Kg / 0,0700 m³

E14 max 6 x 40W

€ 387,20

003399 Bian. Ant.

3000 K
470 lm

101224 € 3,30

IP20

2,000 Kg / 0,0420 m³

E14 max 3 x 40W

€ 233,20

025032 Bian. Ant.

3000 K
470 lm

101224 € 3,30



P. 505





114170

081564

081526

Colossal

Montatura e dettagli in metallo cromato. Bracci in vetro soffiato trasparente o con interno di colore grigio o bianco avorio. Pendagli ed elementi decorativi in vetro trasparente e cristallo molato. Copricatena in velluto.

IP20	IP20	IP20
19,000 Kg / 0,2828 m³ E14 max 15 x 40W	11,400 Kg / 0,1386 m³ E14 max 8 x 40W	9,200 Kg / 0,1095 m³ E14 max 6 x 40W
€ 1210	€ 770	€ 605
114170 Trasparen. 081564 Avorio 081526 Grigio	114187 Trasparen. 081557 Avorio 081519 Grigio	114194 Trasparen. 081540 Avorio 081502 Grigio
3000 K 470 lm	3000 K 470 lm	3000 K 470 lm
101224 € 3,30	101224 € 3,30	101224 € 3,30



Rose

Lampadario in vetro soffiato con dettagli in metallo cromato. Ottagoni e gocce in cristallo molato. Copricatena in velluto.

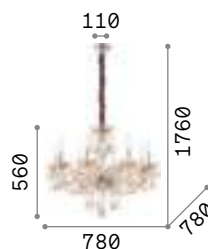

IP20

7,630 Kg / 0,1321 m³
E14 max 8 x 40W

€ 550

166889 ■ Ambra

3000 K
430 lm

101248 € 3,30

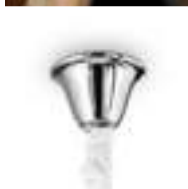

Negresco

Montatura in metallo con finitura in cromo o dorata. Bracci in vetro soffiato trasparente con interno dorato nella versione oro. Centrale composto da blocchi di cristallo molato. Elementi decorativi in vetro trasparente e cristallo molato. Copricatena in velluto.



141060



087771

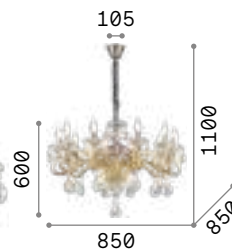

IP20

14,400 Kg / 0,1687 m³
E14 max 10 x 40W

€ 990

141060 Trasparen.
087771 Oro

3000 K
430 lm

101248 € 3,30

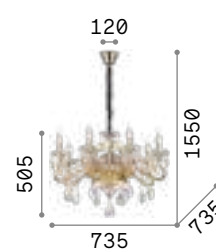

IP20

11,300 Kg / 0,1461 m³
E14 max 8 x 40W

€ 847

141053 Trasparen.
087764 Oro

3000 K
430 lm

101248 € 3,30



P. 418



Continental

Montatura e dettagli in metallo cromato. Bracci in vetro soffiato. Pendagli ed elementi decorativi in vetro trasparente e cristallo molato. Copricatena in velluto.

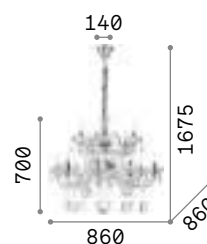

IP20

14,900 Kg / 0,2574 m³
E14 max 12 x 40W

€ 1023

207483 Trasparen.

3000 K
470 lm

101224 € 3,30

Tiepolo

Lampadario in vetro soffiato lavorato a mano con dettagli in metallo cromato. Pendagli con ottagoni e gocce in cristallo molato. Copricatena in velluto.

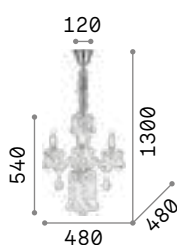
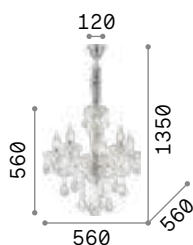
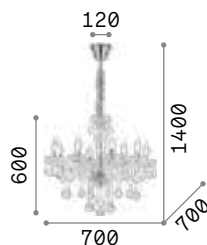

7,220 Kg / 0,1080 m³

E14 max 8 x 40W

€ 605

034720 ■ Trasparen.



3000 K
370 lm

101231 € 3,30



5,120 Kg / 0,0791 m³

E14 max 5 x 40W

€ 495

034713 ■ Trasparen.



3000 K
370 lm

101231 € 3,30



3,650 Kg / 0,0609 m³

E14 max 3 x 40W

€ 330

034706 ■ Trasparen.



3000 K
370 lm

101231 € 3,30

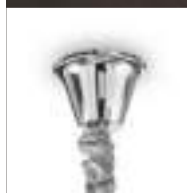

Amadeus

Montatura in metallo cromato. Elementi decorativi in vetro soffiato e cristallo molato. Copricatena in velluto.

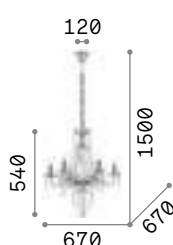
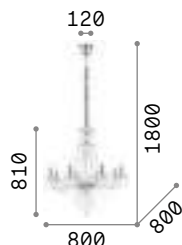

8,200 Kg / 0,1574 m³

E14 max 8 x 40W

€ 528

168777 ■ Trasparen.



3000 K
470 lm

101224 € 3,30



6,700 Kg / 0,1202 m³

E14 max 6 x 40W

€ 440

168753 ■ Trasparen.



3000 K
470 lm

101224 € 3,30





Giudecca

Lampadario in vetro soffiato lavorato a mano con dettagli in metallo cromato. Pendagli con ottagoni e gocce in cristallo molato. Copricatena in velluto. Disponibile nelle finiture trasparente, nero e rosso.

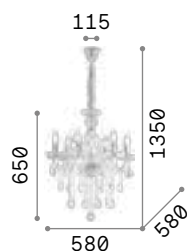

IP20

5,770 Kg / 0,1041 m³
E14 max 6 x 40W

€ 434,50

027821 Trasparen.
032504 Nero
027418 Rosso

101248 3000 K
430 lm
€ 3,30



027821



032504



027418

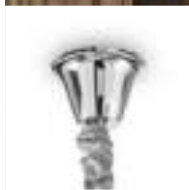

Florian

Montatura in metallo con elementi decorativi in vetro. Pendagli con ottagoni e gocce finali in cristallo molato. Disponibile nelle versioni con vetro trasparente e metallo dorato o cromato.



035604



035611

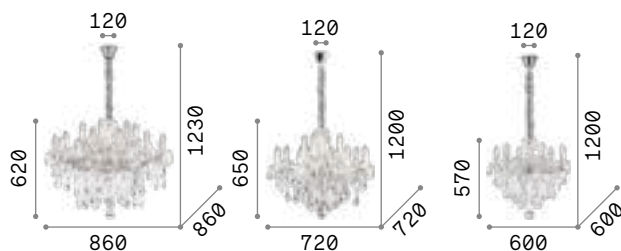

IP20

17,200 Kg / 0,3482 m³
E14 max 18 x 40W

€ 1023

075150 Cromo
075181 Oro

3000 K
470 lm

101224 € 3,30

IP20

9,760 Kg / 0,2187 m³
E14 max 12 x 40W

€ 639,10

035604 Cromo
035611 Oro

3000 K
470 lm

101224 € 3,30

IP20

6,380 Kg / 0,1368 m³
E14 max 6 x 40W

€ 493,90

035628 Cromo
035635 Oro

3000 K
470 lm

101224 € 3,30





Napoleon

Montatura in metallo cromato o dorato. Elementi decorativi in vetro soffiato e cristallo molato. Copricatena in velluto.



167244



167398

17,920 Kg / 0,4424 m³ E14 max 18 x 40W	11,260 Kg / 0,2633 m³ E14 max 12 x 40W	9,070 Kg / 0,2156 m³ E14 max 8 x 40W
€ 1001	€ 629,20	€ 592,90
167268 Cromo 167411 Oro	167251 Cromo 167404 Oro	167244 Cromo 167398 Oro
3000 K 470 lm	3000 K 470 lm	3000 K 470 lm
101224 € 3,30	101224 € 3,30	101224 € 3,30



Gioconda

Corpo luce in fusione di metallo con finitura oro o argento antico. Pendagli ottagonali e tondi in cristallo molato. Copricatena in velluto.

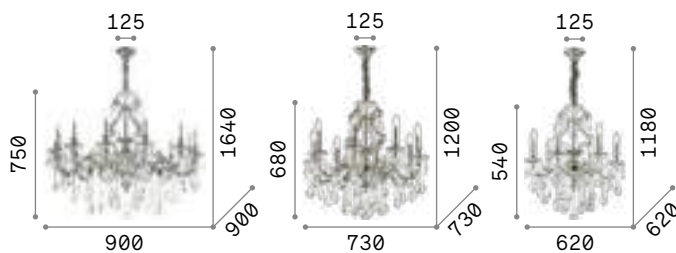

IP20

18,100 Kg / 0,1360 m³
E14 max 12 x 40W

€ 1353

164953 Argento
164960 Oro

3000 K
470 lm

101224 € 3,30

IP20

9,060 Kg / 0,0809 m³
E14 max 8 x 40W

€ 957

044934 Argento
060514 Oro

3000 K
470 lm

101224 € 3,30

IP20

6,340 Kg / 0,0682 m³
E14 max 6 x 40W

€ 715

044927 Argento
060507 Oro

3000 K
470 lm

101224 € 3,30



164953



164960



P. 419

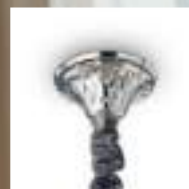

Impero

Corpo luce in fusione di metallo con finitura argento antico. Elementi decorativi in cristallo molato. Copricatena in velluto.

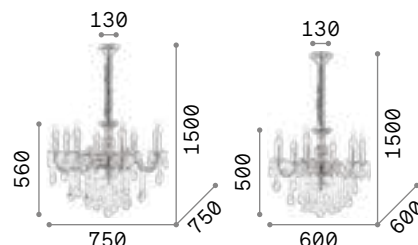

IP20

7,500 Kg / 0,0454 m³
E14 max 8 x 40W

€ 825

014395 ■ Argento

3000 K
470 lm

101224 € 3,30

IP20

5,000 Kg / 0,0340 m³
E14 max 6 x 40W

€ 550

002408 ■ Argento

3000 K
470 lm

101224 € 3,30

Liberty

Montatura in metallo verniciato color ruggine. Elementi decorativi in cristallo molato. Copricatena in velluto.

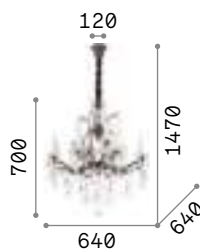

IP20

8,660 Kg / 0,2042 m³
E14 max 12 x 40W

€ 737

166551 ■ Ruggine

3000 K
470 lm

101224 € 3,30

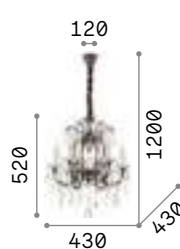

IP20

5,300 Kg / 0,1160 m³
E14 max 6 x 40W

€ 495

073729 ■ Ruggine

3000 K
470 lm

101224 € 3,30

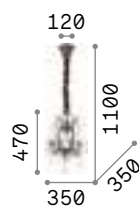

IP20

3,800 Kg / 0,0643 m³
E14 max 4 x 40W

€ 363

166544 ■ Ruggine

3000 K
470 lm

101224 € 3,30



Cascina

Montatura ed elementi decorativi a foglia in metallo lavorato artigianalmente. Decorato a mano con vernice bianca e oro.

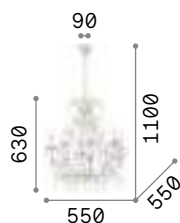

IP20

4,000 Kg / 0,2288 m³
E14 max 8 x 40W

€ 401,50

100289 ■ Bian. Ant.

3000 K
470 lm

101224 € 3,30

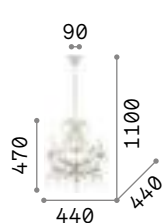

IP20

2,300 Kg / 0,0851 m³
E14 max 5 x 40W

€ 253

100272 ■ Bian. Ant.

3000 K
470 lm

101224 € 3,30



Corte

Montatura completamente in metallo modellato con lavorazione artigianale. Finitura dipinta a mano con effetto antichizzato. Disponibile nella versione bianca o ruggine.

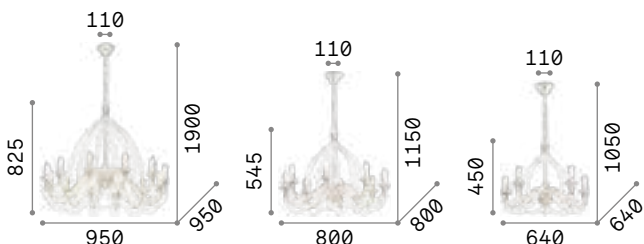

IP20

7,100 Kg / 0,6840 m³
E14 max 12 x 40W

€ 368,50

097664 **Bian. Ant.**
097671 **Ruggine**

3000 K
470 lm

101224 € 3,30

IP20

5,220 Kg / 0,3169 m³
E14 max 8 x 40W

€ 258,50

005898 **Bian. Ant.**
057194 **Ruggine**

3000 K
470 lm

101224 € 3,30

IP20

3,180 Kg / 0,1500 m³
E14 max 5 x 40W

€ 165

005881 **Bian. Ant.**
057187 **Ruggine**

3000 K
470 lm

101224 € 3,30



P. 417

005881

057187



Sem

Montatura completamente in metallo modellato con lavorazione artigianale. Rifinito con vernice satinata bianca.

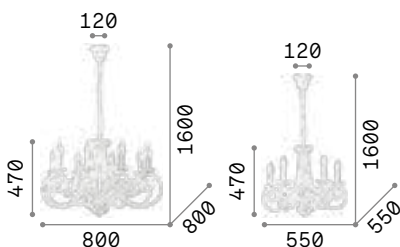

IP20

4,300 Kg / 0,1593 m³
E14 max 8 x 40W

€ 489,50

092782 **Bianco**

3000 K
470 lm

101224 € 3,30

IP20

2,200 Kg / 0,0773 m³
E14 max 5 x 40W

€ 313,50

092751 **Bianco**

3000 K
470 lm

101224 € 3,30





Strauss

Montatura e dettagli in metallo con finitura oro. Bracci in vetro soffiato trasparente. Elementi decorativi in cristallo ambrato. Copricatena in velluto.

IP20	IP20	IP20
20,700 Kg / 0,4508 m³ E14 max 18 x 40W	14,930 Kg / 0,3414 m³ E14 max 12 x 40W	7,410 Kg / 0,1420 m³ E14 max 6 x 40W
€ 1320	€ 990	€ 550
140629 Oro	140612 Oro	140605 Oro
3000 K 430 lm	3000 K 430 lm	3000 K 430 lm
101248 € 3,30	101248 € 3,30	101248 € 3,30





Rialto

Lampadario in vetro trasparente soffiato e lavorato a mano, rifinito con ambra in pasta di vetro. La coppa interna è in metallo ottonato.

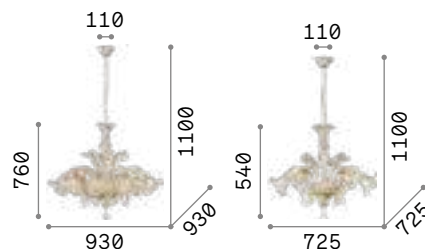

IP20

9,900 Kg / 0,1821 m³
E14 max 8 x 40W

€ 1100

004099 ■ Ambra

3000 K
480 lm

101200 € 3,30

IP20

6,970 Kg / 0,1485 m³
E14 max 5 x 40W

€ 990

009704 ■ Ambra

3000 K
480 lm

101200 € 3,30



Casanova

Lampadario in vetro soffiato e lavorato a mano con copri portalampane e dettagli in metallo cromato. Disponibile trasparente, bianco o fumè.

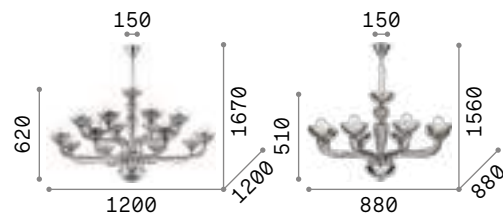

IP20

15,960 Kg / 0,2445 m³
E14 max 16 x 40W

€ 1485

044248 Trasparen.
094120 Bianco
095639 Fumè

3000 K
480 lm

101200 € 3,30

IP20

9,210 Kg / 0,1592 m³
E14 max 8 x 40W

€ 715

044255 Trasparen.
094045 Bianco
095615 Fumè

3000 K
480 lm

101200 € 3,30



044255



094045



095615



Doge

Lampadario in vetro, trasparente o bianco, soffiato e lavorato a mano. Montatura e dettagli in metallo rifinito in cromo.



044422

113678

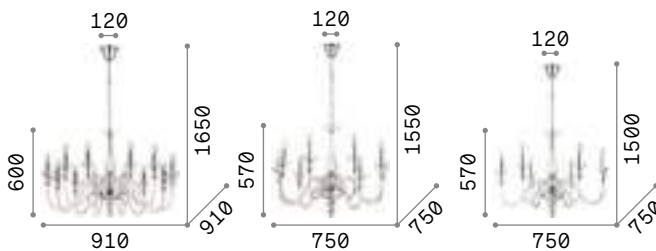

IP20

IP20

IP20

9,400 Kg / 0,3064 m³
E14 max 12 x 40W

6,660 Kg / 0,2229 m³
E14 max 9 x 40W

5,240 Kg / 0,1602 m³
E14 max 6 x 40W

€ 671

€ 550

€ 473

168906 ■ Trasparen.

044453 ■ Trasparen.

044422 ■ Trasparen.
113678 ■ Bianco

3000 K
470 lm



3000 K
470 lm



3000 K
470 lm

101224 € 3,30

101224 € 3,30

101224 € 3,30



Danieli

Montatura in metallo cromato o dorato. Elementi decorativi in vetro soffiato trasparente o ambrato. Copricatena in velluto.



159980



159973

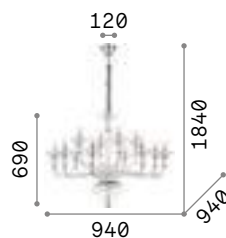

IP20

10,180 Kg / 0,2477 m³
E14 max 12 x 40W

€ 880

213484 Trasparen.
221373 Ambra

3000 K
480 lm

101200 € 3,30

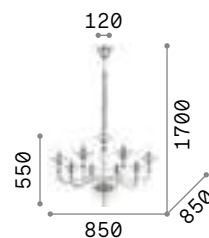

IP20

7,510 Kg / 0,2048 m³
E14 max 8 x 40W

€ 605

159980 Trasparen.
159973 Ambra

3000 K
480 lm

101200 € 3,30

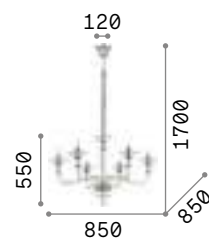

IP20

3,840 Kg / 0,1759 m³
E14 max 6 x 40W

€ 550

159959 Trasparen.
159942 Ambra

3000 K
480 lm

101200 € 3,30



Brigitta

Lampadario in vetro soffiato trasparente o ambrato, lavorato artigianalmente con montatura in metallo e copricatena in velluto.

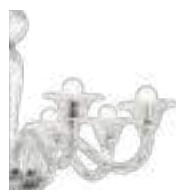

199382



199412

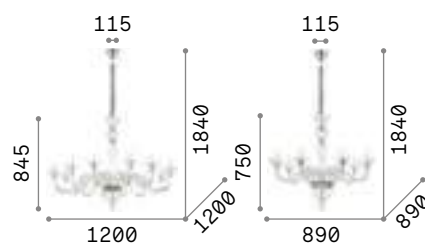

IP20

12,500 Kg / 0,2380 m³
E14 max 12 x 40W

€ 935

199375 Trasparen.
199405 Ambra

3000 K
480 lm

101200 € 3,30

IP20

7,700 Kg / 0,1797 m³
E14 max 8 x 40W

€ 693

199382 Trasparen.
199412 Ambra

3000 K
480 lm

101200 € 3,30



Miramare

Lampadario in vetro trasparente e bianco soffiato e lavorato a mano. Copri portalampade e dettagli in metallo cromato. Copricatena in velluto.

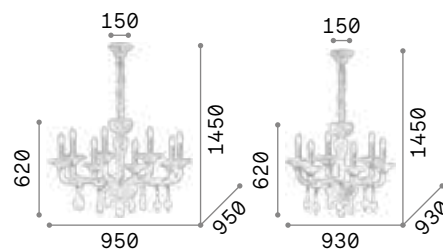

IP20

8,800 Kg / 0,1653 m³
E14 max 8 x 40W

€ 577,50

068190 Bianco

3000 K
470 lm

101224 € 3,30

IP20

8,100 Kg / 0,1437 m³
E14 max 6 x 40W

€ 500,50

068183 Bianco

3000 K
470 lm

101224 € 3,30



Bon Bon

Montatura con bracci in fusione di metallo rifinito con vernice opaca bianca o nera. Bobeche in vetro soffiato nella versione bianca, in metallo in quella nera. Copricatena in velluto.

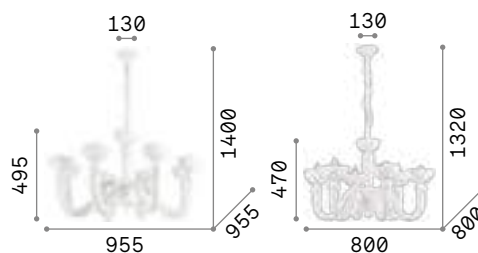

IP20

11,710 Kg / 0,1953 m³
E14 max 8 x 40W

€ 880

094007 ■ Bianco

3000 K
420 lm

101217 € 3,30

IP20

8,110 Kg / 0,1547 m³
E14 max 6 x 40W

€ 605

093994 ■ Bianco
140339 ■ Nero

3000 K
420 lm

101217 € 3,30



093994



140339



Firenze

Corpo luce in resina. Bracci e foglie in metallo modellato artigianalmente. Decorato a mano con foglia d'oro e antichizzato.

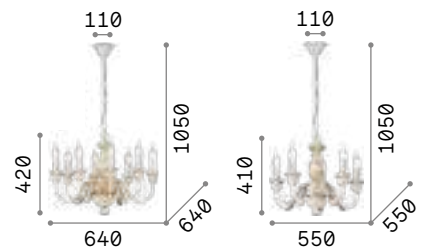

IP20

6,440 Kg / 0,0842 m³
E14 max 8 x 40W

€ 495

012872 Bian. Ant.
020839 Oro

3000 K
430 lm

101248 € 3,30

IP20

4,360 Kg / 0,0609 m³
E14 max 5 x 40W

€ 385

012865 Bian. Ant.
020822 Oro

3000 K
430 lm

101248 € 3,30



012872



020839



P. 420



P. 461



P. 505



Justine

Rosone e montatura in metallo con bracci in fusione. Rifinito con vernice opaca bianca. Copricatena in velluto.

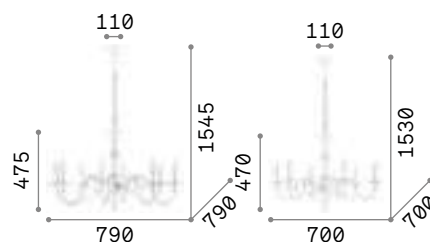

IP20

4,550 Kg / 0,3281 m³
E14 max 8 x 40W

€ 517

197524 Bianco

3000 K
430 lm

101248 € 3,30

IP20

3,440 Kg / 0,2592 m³
E14 max 6 x 40W

€ 385

197500 Bianco

3000 K
430 lm

101248 € 3,30



Artù

Montatura in nickel con finitura lucida. Alle estremità dei bracci, elementi decorativi in cristallo molato. Copricatena in velluto.

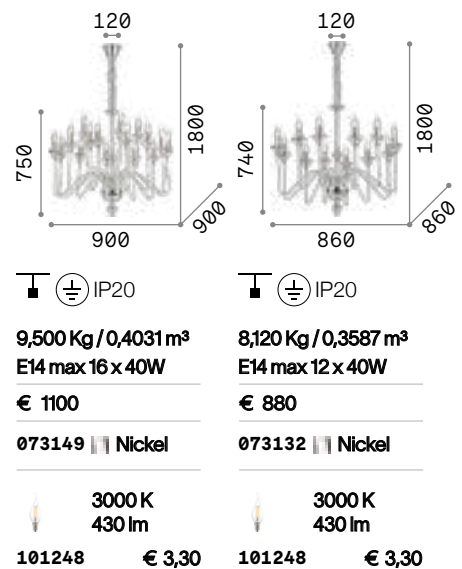



Vanity

Montatura in metallo dorato con dettagli nero opaco. Elementi decorativi in cristallo molato. Copricatena in velluto.

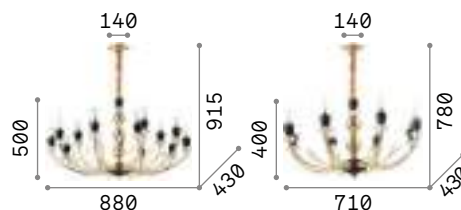

IP20

8,850 Kg / 0,2878 m³
E14 max 15 x 40W

€ 621,50

206639 Oro

3000 K
470 lm

101224 € 3,30

IP20

4,940 Kg / 0,1454 m³
E14 max 8 x 40W

€ 402,60

206622 Oro

3000 K
470 lm

101224 € 3,30



Harem

Montatura con decori in rilievo in metallo brunito e ottagononi in cristallo molato incastonati. Diffusori in vetro soffiato trasparente leggermente ambrato con pendaglio a nappa. Copricatena in velluto.

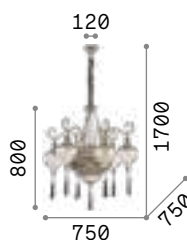

IP20

8,550 Kg / 0,2571 m³
E27 max 9 x 60W

€ 1159,40

116006 ■ Brunito

3000 K
910 lm

119571 € 7,70

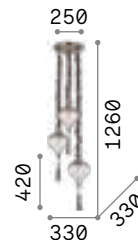

IP20

3,150 Kg / 0,0604 m³
E27 max 3 x 60W

€ 413,60

115986 ■ Brunito

3000 K
910 lm

119571 € 7,70

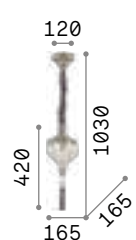

IP20

0,980 Kg / 0,0228 m³
E27 max 1 x 60W

€ 168,30

115979 ■ Brunito

3000 K
910 lm

119571 € 7,70



P. 422



Nawa

Diffusore in metallo traforato con
finitura effetto argento e ottagoni
in cristallo incastonati.

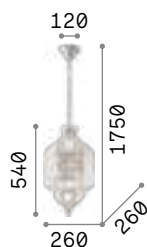

IP20

2,760 Kg / 0,0852 m³
E27 max 3x60W

€ 468,60

141923 ■ Argento

3000 K
910 lm
119571 € 7,70

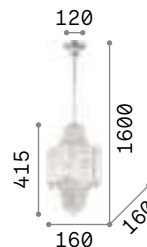

IP20

2,100 Kg / 0,0368 m³
E27 max 1x60W

€ 312,40

138343 ■ Argento

3000 K
910 lm
119571 € 7,70



IP20

1,350 Kg / 0,0368 m³
E27 max 1x60W

€ 220

140827 ■ Argento

3000 K
910 lm
119571 € 7,70



Chalet

Montatura con struttura portante in metallo. Elementi decorativi in resina lavorata artigianalmente e dipinta a mano come fedele riproduzione di corna e legno intagliato.

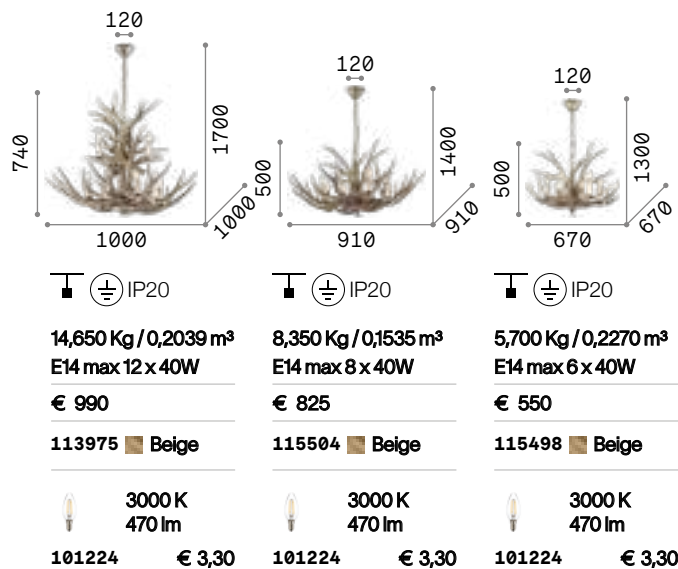

P. 420



P. 460



Driftwood

Rosone in metallo. Struttura sospesa di rami naturali. Copri portalampade in metallo spazzolato.

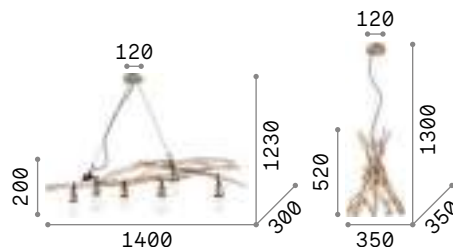

□ IP20

4,500 Kg / 0,1402 m³
E27 max 6x 60W

€ 416,90

180922 **Legno**

💡 2200 K
370 lm

151687 € 6,05

⊕ IP20

1,240 Kg / 0,0599 m³
E27 max 1x 60W

€ 293,70

129600 **Legno**

💡 2200 K
370 lm

151687 € 6,05



P. 458

P. 492



Canapa

Montatura in metallo verniciato.
Cavi elettrici e diffusori rivestiti in
corda di canapa naturale.

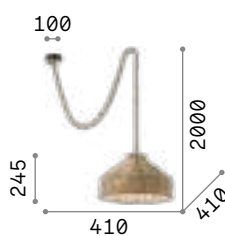

IP20

2,190 Kg / 0,0944 m³
E27 max 1x15W

€ 167,20

134833 Corda

3000 K
910 lm
119571 € 7,70



IP20

0,650 Kg / 0,0063 m³
E27 max 2x15W

€ 58,30

134840 Corda

3000 K
910 lm
119571 € 7,70

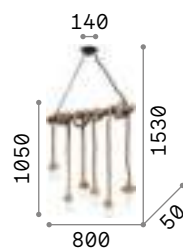

IP20

2,410 Kg / 0,0254 m³
E27 max 6x15W

€ 165

134826 Corda

3000 K
910 lm
119571 € 7,70

Electric

Montatura in metallo rifinito corten. Cavo in tessuto.
Portalampane in ceramica smaltata. Cavi in acciaio a lunghezza regolabile.

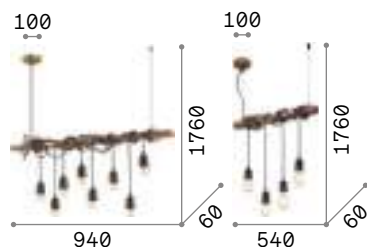

3,000 Kg / 0,0162 m³
E27 max 8 x 60W

€ 290,40

176369 ■ Corten

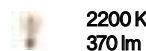

151687 € 6,05



1,800 Kg / 0,0093 m³
E27 max 4 x 60W

€ 194,70

176352 ■ Corten

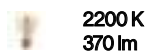

151687 € 6,05



Corda

Montatura e dettagli in metallo verniciato nero opaco con parti rivestite in corda di canapa naturale.

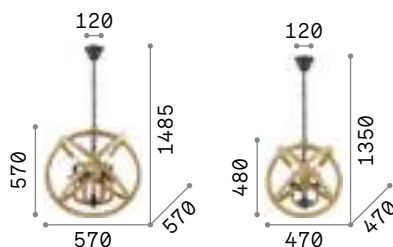

4,550 Kg / 0,2084 m³
E14 max 6 x 40W

€ 335,50

130910 ■ Corda

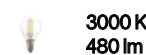

101200 € 3,30



3,580 Kg / 0,1273 m³
E14 max 3 x 40W

€ 236,50

130903 ■ Corda

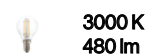

101200 € 3,30





Norma

Montatura in metallo con finitura in cromo o in brunito. Diffusore composto da lastre di vetro trasparente con bordo molato. Copricatena in velluto.



094786



005911

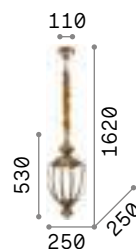

IP20

2,620 Kg / 0,0286 m³
E27 max 1x 60W

€ 212,30

094786 Cromo
005911 Brunito

3000 K
430 lm

101279 € 3,30

Stella

Montatura in metallo modellata artigianalmente. Diffusore composto di lastre di vetro trasparente incastonate nella struttura metallica. Porzione apribile per la sostituzione della lampadina.

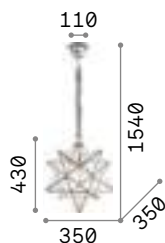

IP20

3,100 Kg / 0,0968 m³

E27 max 1x60W

€ 301,40

093079 Cromo

3000 K
910 lm

119571 € 7,70

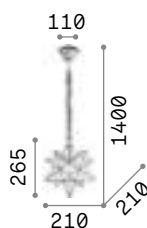

IP20

1,600 Kg / 0,0226 m³

E27 max 1x60W

€ 168,30

093000 Cromo

3000 K
910 lm

119571 € 7,70

Deca

Montatura in metallo con finitura in brunito. Diffusore in lastre di vetro trasparente, apribile per sostituzione lampadina.

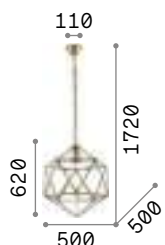

IP20

6,720 Kg / 0,2288 m³

E27 max 1x60W

€ 416,90

168869 Brunito

2200 K
480 lm

151724 € 10,89

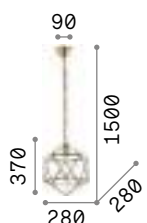

IP20

2,580 Kg / 0,0589 m³

E27 max 1x60W

€ 222,20

168852 Brunito

2200 K
500 lm

151717 € 9,79





Anfora

Montatura in metallo sagomato artigianalmente e smaltato nero.
Diffusore in vetro trasparente soffiato a mano.

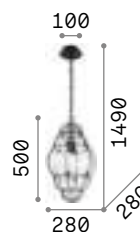

IP20

3,340 Kg / 0,0846 m³
E27 max 1x 42W

€ 169,40

131795 ■ Nero

3000 K
910 lm

119571 € 7,70

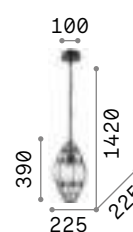

IP20

1,940 Kg / 0,0461 m³
E27 max 1x 42W

€ 136,40

131788 ■ Nero

3000 K
910 lm

119571 € 7,70

Orangerie

Montatura in metallo rifinito brunito. Diffusore in lastre di vetro trasparente. Cavo in tessuto nero.

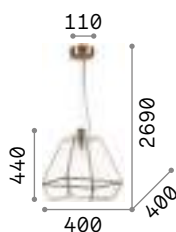

IP20

5,000 Kg / 0,1221 m³
E27 max 1x60W

€ 374

160085 ■ Brunito

3000 K
910 lm

119571 € 7,70

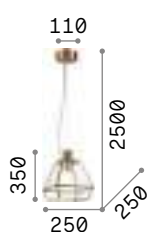

IP20

2,200 Kg / 0,0414 m³
E27 max 1x60W

€ 264

152776 ■ Brunito

3000 K
910 lm

119571 € 7,70



Rondo

Montatura in metallo con finitura in brunito. Diffusore in lastre di vetro trasparente. Cavo in acciaio regolabile in lunghezza.

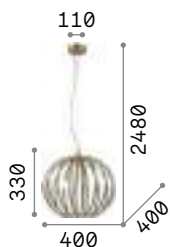

IP20

3,910 Kg / 0,1237 m³
E27 max 1x60W

€ 456,50

168968 ■ Brunito

2200 K
480 lm

151724 € 10,89

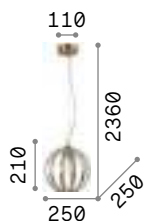

IP20

1,970 Kg / 0,0403 m³
E27 max 1x60W

€ 236,50

168951 ■ Brunito

2200 K
500 lm

151717 € 9,79





Foglia

Montatura in metallo decorato a mano di colore nero. Diffusore in vetro centrifugato con decorazioni in rilievo dipinte a mano.

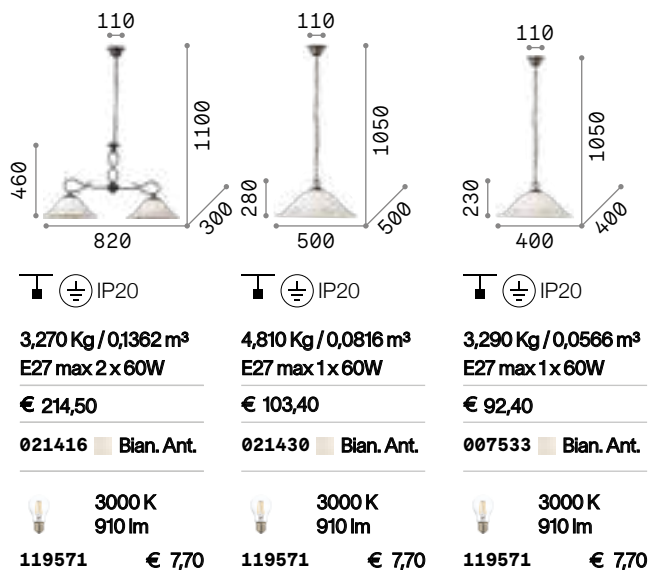



Haunt

Rosone in metallo verniciato bianco opaco. Cavo in tessuto. Diffusore con cesto in vimini al naturale o verniciato in bianco.

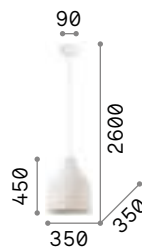

0,460 Kg / 0,0622 m³
E27 max 1x60W

€ 170,50

159256 Bianco
159812 Legno

3000 K
1020 lm

101347 € 9,35



159256



159812



Interni

Lampade da soffitto

Indice alfabetico

Admiral	323	Lika	289	Rain	330
Alfa	304	Lingotto	314	Relax	274
Almond	316	Logos	275	Ring	288
Arizona	280	Look	290	Ritz	285
Bijoux	327	Magnolia	328	Roma	318
Birds	309	Mapa Bianco	280	Royal	326
Caesar	329	Maracas	305	Rudy	301
Candy	281	Martinez	330	Shell	287
Carlton	331	Mood	293	Simply	286
Celine	273	Moonlight	325	Sky	291
Cloud	283	Mouse	300	Slem	304
Compo	317	Multiflex	311	Smarties	279
Cosmopolitan	313	Neve	324	Spark	312
Daisy	316	Nitro	292	Spike	295
Dea	310	Nodi	306	Spot	300
Dony	287	Nodi Crystal	307	Toby	297
Dubai	329	Nodino	307	Totem	275
Dynamite	296	Oak	294	Tower	295
Flat	272	Oby	301	Triumph	308
Fly	260	Ocean	273	Union	272
Frame	256	Octopus	311	Universal R.	268
Geko	277	Oracle Slim	254	Universal S.	270
Gemma	288	Orion	321	Virgin	321
Gingle	276	Ovalino	282	Wheel	285
Glim	302	Oz	259	Winery	299
Glory	278	Pashà	319	Woody	284
Halo	266	Pauline	310		
Karol	258	Petit	298		
King	320	Play	297		
Lana	286	Plumber	308		
Level	278	Quadro	322		



new



Oracle Slim 254



Frame 256



Karol 258



Oz 259



Ocean 273



Relax 274



Totem 275



Logos 275



Candy 281



Ovalino 282

new



Cloud 283



Woody 284



Ring 288



Lika 289



Look 290



Sky 291

new



Toby 297



Petit 298



Winery 299



Mouse 300



Nodi 306

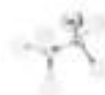

Nodino 307



NodiCrystal 307



Triumph 308

new



Cosmopolitan 313



Lingotto 314



Almond 316



Daisy 316



Admiral 323



Neve 324



Moonlight 325













































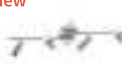

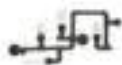









Royal 326

Toby

Pag 297

Interni

Indice icone

						
Fly 260	Halo 266	Universal R. 268	Universal S. 270	Union 272	Flat 272	Celine 273
						
Gingle 276	Geko 277	Glory 278	Level 278	Smarties 279	Arizona 280	MapaBianco 280
						
Wheel 285	Ritz 285	Simply 286	Lana 286	Dony 287	Shell 287	Gemma 288
				 new		
Nitro 292	Mood 293	Oak 294	Tower 295	Spike 295	Dynamite 296	Play 297
				 new	 new	 new
Spot 300	Rudy 301	Oby 301	Glim 302	Alfa 304	Slem 304	Maracas 305
	 new					
Plumber 308	Birds 309	Dea 310	Pauline 310	Multiflex 311	Octopus 311	Spark 312
						
Compo 317	Roma 318	Pashà 319	King 320	Virgin 321	Orion 321	Quadro 322
						
Bijoux 327	Magnolia 328	Dubai 329	Caesar 329	Rain 330	Martinez 330	Carlton 331



Oracle Slim new

Lampada da soffitto costituita da una montatura sottile in alluminio verniciato bianco o nero opaco e diffusore opale in policarbonato. Disponibile nel modello circolare in tre dimensioni diverse. LED integrati, disponibile in temperatura di colore 3000 K, CRI ≥ 80, durata utile LED 17.500 h, protezione IP20, classe isolamento II.

LED Sorgente luminosa LED 3000 K, 17.500 h di durata.

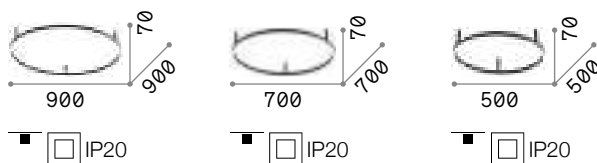

1,700 Kg / 0,1345 m ³ LED 51W / 4060 lm € 291,50	1,430 Kg / 0,0852 m ³ LED 35W / 3050 lm € 236,50	1,240 Kg / 0,0455 m ³ LED 30W / 2350 lm € 192,50
-------------------------------------------------------------------	-------------------------------------------------------------------	-------------------------------------------------------------------

266015 Bianco new	265995 Bianco new	265971 Bianco new
266022 Nero	266008 Nero new	265988 Nero new



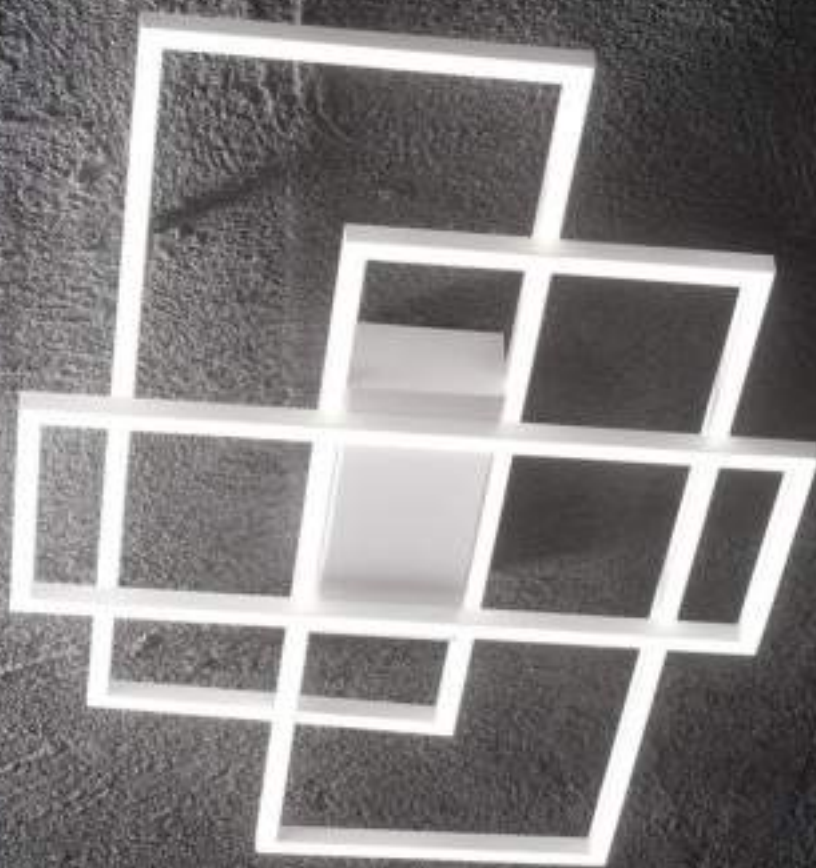

Frame

Base e montatura in metallo verniciato bianco opaco o nero opaco. Diffusori in materiale plastico colore opale. Emissione luce diretta.

LED Sorgente luminosa LED 3000 K, 30.000 h di durata.

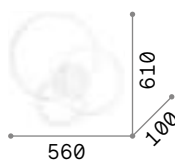
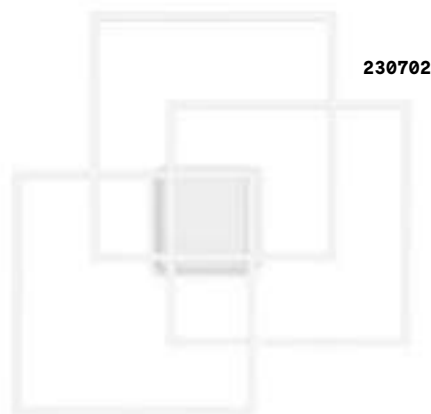
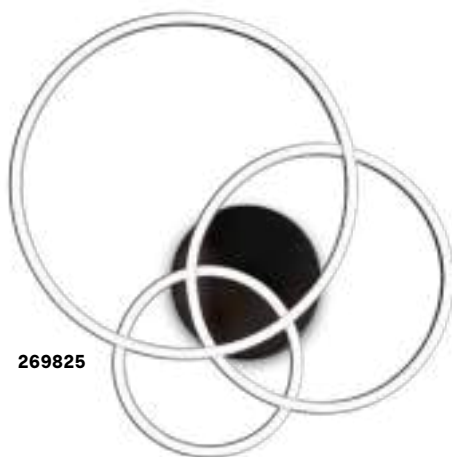

■ ■ □ IP20
1,600 Kg / 0,0458 m³
LED 40W / 2800 lm
€ 313,50

255019 ■ Bianco
 269825 ■ Nero

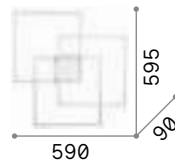

■ ■ □ IP20
1,430 Kg / 0,0530 m³
LED 35W / 3200 lm
€ 313,50

230702 ■ Bianco
 270678 ■ Nero

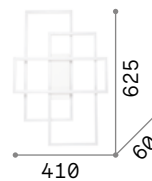

■ ■ □ IP20
1,240 Kg / 0,0264 m³
LED 31W / 2700 lm
€ 280,50

230726 ■ Bianco
 270661 ■ Nero







Karol

Corpo luce in metallo verniciato bianco opaco. Diffusore in materiale plastico colore opale.

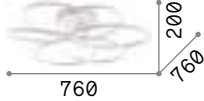
LED Sorgente luminosa LED 4000 K, 10.000 h di durata.

	
760	650
200	180
■ □ ⊕ IP20	■ □ ⊕ IP20
3,430 Kg / 0,185 m ³ LED 90W / 8380 lm	2,300 Kg / 0,0901 m ³ LED 74W / 6900 lm
€ 491,70	€ 363
227832 Bianco	227825 Bianco



Oz

Base e montatura in metallo verniciato a polveri o placcato. Diffusore in gomma opale. Disponibile nelle finiture bianco, nero o ottone spazzolato.

LED Sorgente luminosa LED 3000 K, 30.000 h di durata.

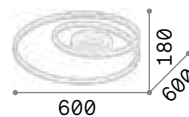

IP20

2,010 Kg / 0,0676 m³
LED 49W / 5000 lm

€ 313,50

253688 ■ Bianco
269412 ■ Nero
269429 ■ Ottone



P. 058

P. 339

P. 430

Fly

Famiglia di lampade a plafone con base circolare, disponibile in quattro diametri diversi (350 mm, 450 mm, 600 mm, 900 mm). Corpo luce in alluminio verniciato a polveri in finitura bianco RAL 9016, ottica arretrata con diffusore in PMMA microprismatizzato con controllo dell'abbagliamento (UGR < 19). La lampada è predisposta per essere integrata con il modulo accessorio uplight per la componente di illuminazione indiretta. Sorgente luminosa a LED integrati; disponibile in temperatura di colore 3000 K e 4000 K; CRI ≥ 80; durata utile LED 50.000 h; protezione IP40, classe isolamento I. Driver incluso, integrato nel corpo illuminante, disponibile in versione dimmerabile 1-10V, DALI e Push. Sistema adatto per ambienti dove richiesta un'illuminazione professionale e uniforme, ad esempio UFFICI e spazi COMMERCIALI. L'elevata resa cromatica lo rende ideale anche per gli spazi espositivi e la valorizzazione della merce in showroom e aree vendita nel settore RETAIL.

PRO Prodotto ad alto contenuto tecnologico, elevata qualità dei materiali, destinato ad uso professionale.

IP40 Grado di protezione IP40.

Sorgente	LED SMD
Potenza	18W / 26W / 50W / 68W
Driver incluso	On/Off
Driver disponibili	1-10V / DALI / Push
MacAdam	SDCM 3
CCT	3000 K / 4000 K
CRI	≥80
UGR	<19
Durata LED	50.000 h
Classe isolamento	I
IP	40
Materiale	Alluminio
Garanzia	5 anni



P. 066





Fly

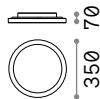

LED SMD SAMSUNG Driver TRIDONIC ON/OFF incluso

Potenza	Angolo	Lumen	CCT	Finitura	Codice	€
18 W	87°	2600 lm	3000 K	Bianco	270272	308
		2800 lm	4000 K	Bianco	270289	308

3,000 Kg/0,0160 m³

DIMMABLE DRIVER Non incluso/Optional

	Potenza	Output	Misura	Codice	€
1-10V/Push	20 W	500 mA	108 x 52 x 22 mm	270333	58,30
DALI	20 W	500 mA	108 x 52 x 22 mm	270364	79,20

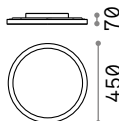

LED SMD SAMSUNG Driver TRIDONIC ON/OFF incluso

Potenza	Angolo	Lumen	CCT	Finitura	Codice	€
26 W	87°	4000 lm	3000 K	Bianco	254272	412,50
		4200 lm	4000 K	Bianco	270296	412,50

3,700 Kg/0,0250 m³

DIMMABLE DRIVER Non incluso/Optional

	Potenza	Output	Misura	Codice	€
1-10V/Push	32 W	700 mA	94 x 67 x 21 mm	270586	67,10
DALI	32 W	700 mA	94 x 67 x 21 mm	270593	90,20

UPLIGHT Non incluso/Optional



Modello	Potenza	Angolo	Lumen	CCT	Codice	€
ø 35	13 W	120°	900 lm	3000 K	270258	77
			1000 lm	4000 K	270395	77
ø 45	13 W	120°	900 lm	3000 K	270258	77
			1000 lm	4000 K	270395	77



Light beam: ACCENT

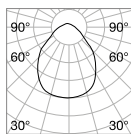

m	lx	Øm
1	2945	1,90
2	736	3,80
3	327	5,60
4	184	7,50
5	116	9,40

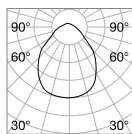

m	lx	Øm
1	1562	1,90
2	390	3,70
3	174	5,60
4	98	7,50
5	62	9,40

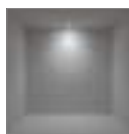

CRI≥83 18W 87° 2600lm 3000K

CRI≥83 26W 87° 4000lm 3000K



Fly

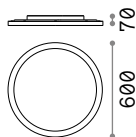

LED SMD SAMSUNG Driver TRIDONIC ON/OFF incluso

Potenza	Angolo	Flux	CCT	Finitura	Codice	€
50 W	87°	8000 lm	3000 K	Bianco	270302	599,50
		8400 lm	4000 K	Bianco	270319	599,50

4,500 Kg/0,0423 m³

DIMMABLE DRIVER Non incluso/Optional

	Potenza	Output	Misura	Codice	€
1-10V	60 W	1400 mA	124 x 82 x 23 mm	270340	100,10
DALI / Push	60 W	1400 mA	125 x 85 x 28 mm	270371	130,90

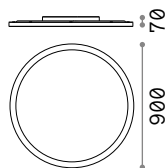

LED SMD SAMSUNG Driver TRIDONIC ON/OFF incluso

Potenza	Angolo	Lumen	CCT	Finitura	Codice	€
68 W	87°	10400 lm	3000 K	Bianco	270326	1155
		10800 lm	4000 K	Bianco	270241	1155

6,900 Kg/0,0903 m³

DIMMABLE DRIVER Non incluso/Optional

	Potenza	Output	Misura	Codice	€
1-10V	68 W	1400 mA	130 x 75 x 25 mm	270357	113,30
DALI / Push	100 W	1400 mA	140 x 100 x 30 mm	270388	174,90

UPLIGHT Non incluso/Optional



Modello	Potenza	Angolo	Lumen	CCT	Codice	€
ø60	20 W	120°	1900 lm	3000 K	270401	134,20
			2000 lm	4000 K	270265	134,20
ø90	28 W	120°	2700 lm	3000 K	271002	202,40
			2900 lm	4000 K	270715	202,40



Light beam: ACCENT

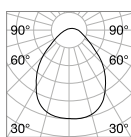

m	lx	Øm
1	2945	1,90
2	736	3,80
3	327	5,60
4	184	7,50
5	116	9,40

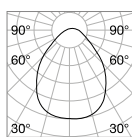
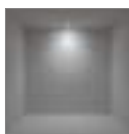

m	lx	Øm
1	3991	1,90
2	998	3,90
3	443	5,80
4	249	7,80
5	160	9,70

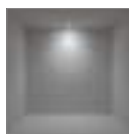

CRI≥83 50W 87° 8000lm 3000K

CRI≥83 68W 87° 10400lm 3000K



Halo

Lampada a plafone con base circolare e corpo luce in alluminio verniciato a polveri. Diffusore opale in policarbonato. Disponibile in tre diversi diametri di colore bianco. Sorgente luminosa a LED integrati con binning iniziale ≤ 2-Step MacAdam; disponibile in temperatura di colore 3000 K e 4000 K; CRI ≥ 80; durata utile LED 35.000 h; protezione IP20, classe isolamento I.

Sorgente	LED SMD	Durata LED	35.000 h
Potenza	25W / 31W / 44W	Classe	I
Driver incluso	On/Off	isolamento	
Driver disponibili	No	IP	20
CCT	3000 K / 4000 K	Materiale	Alluminio
CRI	≥80		
UGR	<22		



Luce indiretta inclusa.



LED SMD Driver ON/OFF incluso

Potenza	Angolo	Lumen	CCT	Finitura	Codice	€
25 W	110°	2200 lm	3000 K	Bianco	223186	294,80
		2500 lm	4000 K	Bianco	223193	294,80

2,750 Kg/0,0177 m³



LED SMD Driver ON/OFF incluso

Potenza	Angolo	Lumen	CCT	Finitura	Codice	€
31 W	110°	2800 lm	3000 K	Bianco	223209	391,60
		3200 lm	4000 K	Bianco	223216	391,60

4,430 Kg/0,0313 m³

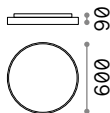

LED SMD Driver ON/OFF incluso

Potenza	Angolo	Lumen	CCT	Finitura	Codice	€
44 W	110°	4300 lm	3000 K	Bianco	223223	544,50
		5000 lm	4000 K	Bianco	223230	544,50

6,600 Kg/0,0566 m³



P. 067



Universal Round

Plafoniera diffusiva per installazione a soffitto o parete in interni, adatta per un'illuminazione generale e uniforme. Scocca in acciaio verniciato con finitura bianca, diffusore in materiale plastico. Sorgente luminosa integrata a LED, disponibile in 4 potenze differenti. Durata utile LED 17.500 h; protezione IP20, classe isolamento II.

Sorgente	LED SMD	Classe	II
Potenza	13,5W / 32W	isolamento	
Driver incluso	On/Off	IP	20
Driver disponibili	No	Materiale	Acciaio
CCT	3000 K		
CRI	≥80		
Durata LED	17.500 h		

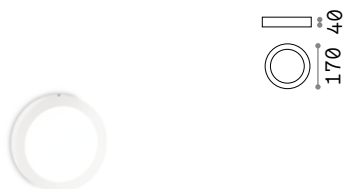

0,420 Kg/0,0015 m³

LED SMD Driver ON/OFF incluso

Potenza	Angolo	Lumen	CCT	Finitura	Codice	€
13,5 W	110°	840 lm	3000 K	Bianco	138596	31,90



0,580 Kg/0,0025 m³

LED SMD Driver ON/OFF incluso

Potenza	Angolo	Lumen	CCT	Finitura	Codice	€
19 W	110°	1250 lm	3000 K	Bianco	138602	38,50



0,850 Kg/0,0045 m³

LED SMD Driver ON/OFF incluso

Potenza	Angolo	Lumen	CCT	Finitura	Codice	€
25 W	110°	1800 lm	3000 K	Bianco	138619	55

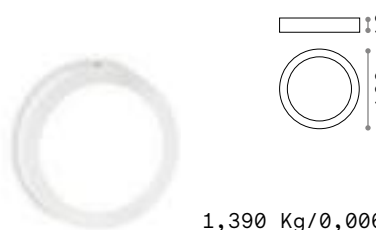

1,390 Kg/0,0068 m³

LED SMD Driver ON/OFF incluso

Potenza	Angolo	Lumen	CCT	Finitura	Codice	€
32 W	110°	3060 lm	3000 K	Bianco	240367	88



Universal Square

Plafoniera diffusiva per installazione a soffitto o parete in interni, adatta per un'illuminazione generale e uniforme. Scocca in acciaio verniciato con finitura bianca, diffusore in materiale plastico. Sorgente luminosa integrata a LED, disponibile in 4 potenze differenti. Durata utile LED 17.500 h; protezione IP20, classe isolamento II.

Sorgente	LED SMD	Classe	II
Potenza	13,5W / 32W	isolamento	
Driver incluso	On/Off	IP	20
Driver disponibili	No	Materiale	Acciaio
CCT	3000 K		
CRI	≥80		
Durata LED	17.500 h		



0,510 Kg/0,0015 m³

LED SMD Driver ON/OFF incluso

Potenza	Angolo	Lumen	CCT	Finitura	Codice	€
13,5 W	110°	840 lm	3000 K	Bianco	138633	31,90



0,710 Kg/0,0025 m³

LED SMD Driver ON/OFF incluso

Potenza	Angolo	Lumen	CCT	Finitura	Codice	€
19 W	110°	1250 lm	3000 K	Bianco	138640	38,50



1,070 Kg/0,0045 m³

LED SMD Driver ON/OFF incluso

Potenza	Angolo	Lumen	CCT	Finitura	Codice	€
25 W	110°	1800 lm	3000 K	Bianco	138657	55

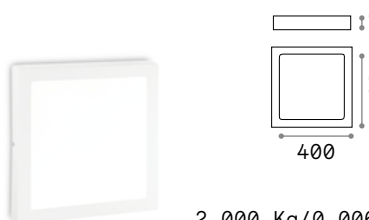

2,000 Kg/0,0068 m³

LED SMD Driver ON/OFF incluso





Potenza	Angolo	Lumen	CCT	Finitura	Codice	€
32 W	110°	3060 lm	3000 K	Bianco	240374	88

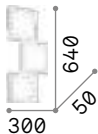
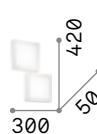
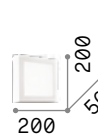

Union

Montatura in metallo rifinito con vernice opaca bianca. Diffusore con lastra di vetro trasparente acidato, fissato con magneti.

LED Lampadine LED GX53 9W 3000 K
includ. Cod. **123936**







		
3,950 Kg / 0,0368 m ³ GX53 max 3 x 15W	2,640 Kg / 0,0257 m ³ GX53 max 2 x 15W	1,360 Kg / 0,0092 m ³ GX53 max 1 x 15W
€ 244,20	€ 162,80	€ 83,60
142203 Bianco	142197 Bianco	116099 Bianco
 3000 K 910 lm	 3000 K 910 lm	 3000 K 910 lm
123936 € 7,15	123936 € 7,15	123936 € 7,15



Flat

Montatura in metallo smaltato bianco opaco. Diffusore in lastra di acrilico satinato trasparente.

LED Lampadine LED GX53 9W 3000 K
includ. Cod. **123936**

		
2,480 Kg / 0,0263 m ³ GX53 max 4 x 15W	1,620 Kg / 0,0159 m ³ GX53 max 4 x 15W	0,700 Kg / 0,0088 m ³ GX53 max 1 x 15W
€ 220	€ 132	€ 88
134901 Bianco	134895 Bianco	134888 Bianco
 3000 K 910 lm	 3000 K 910 lm	 3000 K 910 lm
123936 € 7,15	123936 € 7,15	123936 € 7,15



Celine

Base in metallo smaltato. Diffusore in vetro trasparente sabbato. Viti ferma vetro in metallo cromato.

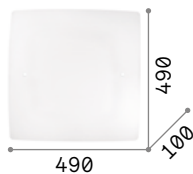

IP20

2,540 Kg / 0,0467 m³
E27 max 4x60W

€ 101,20

044293 Bianco

101286 € 3,30

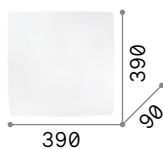

IP20

1,740 Kg / 0,0296 m³
E27 max 3x60W

€ 59,40

044286 Bianco

101286 € 3,30

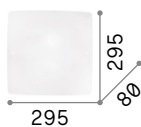

IP20

1,120 Kg / 0,0189 m³
E27 max 2x60W

€ 46,20

044279 Bianco

101286 € 3,30

Ocean

Diffusore composto da due lastre di vetro: sotto con bordo a specchio e smerigliato al centro, sopra con decorazione serigrafata e applicazioni di bottoni in vetro.

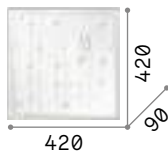

IP20

2,930 Kg / 0,0281 m³
E27 max 3x60W

€ 110

081441 Trasparen.
091013 Color

101286 € 3,30

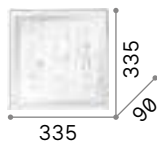

IP20

1,930 Kg / 0,0160 m³
E27 max 2x60W

€ 72,60

081434 Trasparen.
091006 Color

101286 € 3,30

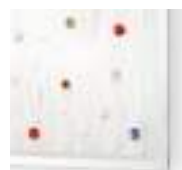

091013



0801441



Relax

Montatura in metallo rifinito con vernice opaca bianca. Diffusori in policarbonato opale. Doppia emissione luminosa: principale e laterale. Sorgente LED sostituibile. Alimentatore dimmerabile integrato.

LED Sorgente luminosa LED 3000 K, 17.500 h di durata.

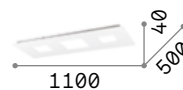

8,190 Kg / 0,0740 m³
LED 84W / 8100 lm

€ 492,80

255941 Bianco

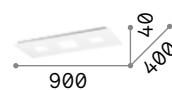

5,760 Kg / 0,0486 m³
LED 65W / 6100 lm

€ 382,80







255934 Bianco

Totem

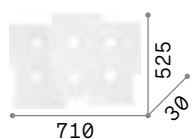
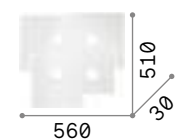
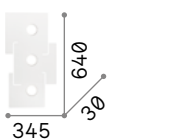
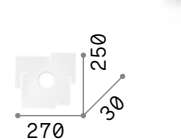
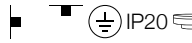
Base in metallo sagomato a laser e verniciato bianco opaco. Sorgenti luminose a LED sostituibili.

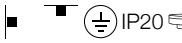
LED Lampadine LED GX53 9W 3000 K incluse. Cod. **123936**

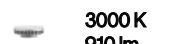

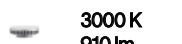
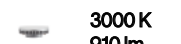



			
710 525 30	560 510 30	345 640 30	270 250 30
			
5,320 Kg / 0,0470 m ³ GX53 max 6 x 15W	3,890 Kg / 0,0322 m ³ GX53 max 4 x 15W	2,960 Kg / 0,0227 m ³ GX53 max 3 x 15W	0,960 Kg / 0,0055 m ³ GX53 max 1 x 15W
€ 247,50	€ 201,30	€ 169,40	€ 73,70
215785 Bianco	215778 Bianco	215761 Bianco	215747 Bianco
 3000 K 910 lm	 3000 K 910 lm	 3000 K 910 lm	 3000 K 910 lm
123936 € 7,15	123936 € 7,15	123936 € 7,15	123936 € 7,15

Logos

Montatura in metallo con finitura in vernice bianca opaca. Sorgenti luminose a LED sostituibili.

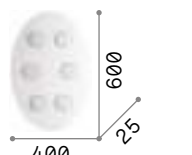
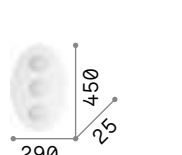
LED Lampadine LED GX53 9W 3000 K incluse. Cod. **123936**

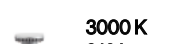

	
400 600 25	290 450 25
	
2,850 Kg / 0,0278 m ³ GX53 max 6 x 15W	1,450 Kg / 0,0160 m ³ GX53 max 3 x 15W
€ 291,50	€ 181,50
175799 Bianco	175768 Bianco
 3000 K 910 lm	 3000 K 910 lm
123936 € 7,15	123936 € 7,15



Gingle

Base e corpo luce in metallo verniciato a polveri. Sorgente luminosa a led integrati con emissione di luce riflessa.



Sorgente luminosa LED 3000 K, 17.500 h di durata.

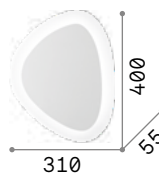

1,540 Kg / 0,0233 m³
LED 34W / 3550 lm

€ 302,50

196220 Bianco

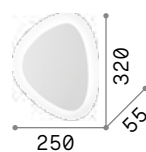

1,000 Kg / 0,0139 m³
LED 26W / 2580 lm

€ 214,50

196206 Bianco

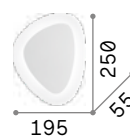

0,730 Kg / 0,0153 m³
LED 18W / 1940 lm











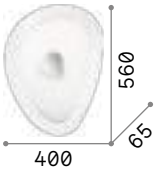
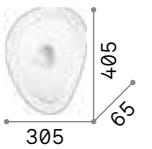
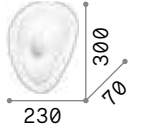





€ 159,50

196190 Bianco



Geko

Montatura in metallo smaltato bianco. Diffusore con vetro trasparente serigrafato in bianco. Elemento centrale fissa vetro in metallo cromato.

		
400	305	230
560	405	300
65	65	70
   IP20	   IP20	   IP20
3,820 Kg / 0,0385 m³	2,000 Kg / 0,0203 m³	1,200 Kg / 0,0130 m³
E27 max 4 x 60W	E27 max 3 x 60W	E27 max 2 x 60W
€ 173,80	€ 118,80	€ 82,50
116112  Bianco	018508  Bianco	010861  Bianco
 3000 K 340 lm	 3000 K 340 lm	 3000 K 340 lm
101286 € 3,30	101286 € 3,30	101286 € 3,30

Glory

Montatura in metallo con finitura nickel satinato. Diffusore in vetro bianco soffiato e acidato.

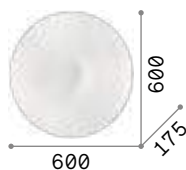

IP20

4,810 Kg / 0,1789 m³
E27 max 5 x 60W

€ 368,50

019765 Bianco

3000 K
340 lm
101286 € 3,30

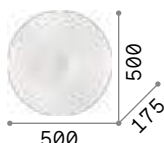

IP20

3,410 Kg / 0,0744 m³
E27 max 3 x 60W

€ 214,50

019758 Bianco

3000 K
340 lm
101286 € 3,30

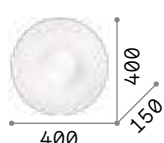

IP20

2,100 Kg / 0,0700 m³
E27 max 2 x 60W

€ 187

101132 Bianco

3000 K
340 lm
101286 € 3,30



P. 147

Level

Base in metallo verniciato a polveri. Diffusore in vetro soffiato bianco acidato con sistema di fissaggio senza viti. Sorgente a led integrato facilmente sostituibile.

LED Sorgente luminosa LED 3000 K, 17.500 h di durata.

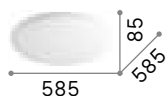

IP20

5,120 Kg / 0,1122 m³
LED 24W / 2100 lm

€ 330

261188 Bianco

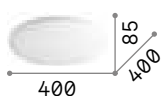

IP20

2,360 Kg / 0,0541 m³
LED 18W / 1600 lm

€ 176

261164 Bianco





Smarties

Montatura in metallo verniciato bianco. Diffusore in vetro bianco soffiato.

IP20	IP20	IP20	IP20
4,690 Kg / 0,1480 m ³ E27 max 3 x 60W	3,070 Kg / 0,1009 m ³ E27 max 3 x 60W	2,810 Kg / 0,0599 m ³ E27 max 2 x 60W	1,440 Kg / 0,0454 m ³ E27 max 1 x 60W
€ 275	€ 187	€ 165	€ 110
032023 Bianco	032030 Bianco	032047 Bianco	009223 Bianco
3000 K 340 lm	3000 K 340 lm	3000 K 340 lm	3000 K 340 lm
101286 € 3,30	101286 € 3,30	101286 € 3,30	101286 € 3,30



P. 146



P. 360



P. 440

Arizona

Montatura in metallo rifinito in ottone satinato. Diffusore in vetro bianco soffiato, acidato e con rigature decorative in rilievo.

LED Lampadine LED GX53 9W 3000 K incluse. Cod. **123936**

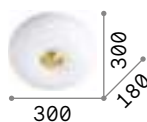
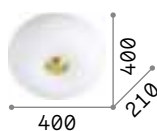
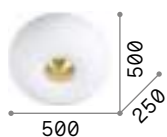

7,680 Kg / 0,1299 m³
GX53 max 5 x 15W

3,050 Kg / 0,0744 m³
GX53 max 3 x 15W

2,960 Kg / 0,0452 m³
GX53 max 2 x 15W

€ 489,50

€ 319

€ 223,30

214511 Bianco

214504 Bianco

214498 Bianco

3000 K
910 lm

3000 K
910 lm

3000 K
910 lm

123936 € 7,15

123936 € 7,15

123936 € 7,15



P. 148

Mapa Bianco

Base e sistema di fissaggio in metallo bianco. Diffusore a sfera in vetro bianco soffiato e acidato.



2,590 Kg / 0,1290 m³
E27 max 1 x 60W

€ 188,10

059839 Bianco

3000 K
910 lm



119571 € 7,70

P. 156

P. 360

P. 441



Candy

Montatura in metallo con finitura nickel satinato. Diffusore in vetro bianco soffiato e acidato.

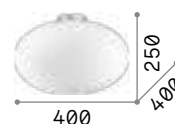

IP20

2,500 Kg / 0,0799 m³
E27 max 1x60W

€ 196,90

086781 Bianco

3000 K
900 lm

123899 € 7,70



P. 149



P. 440



Ovalino

Montatura in metallo smaltato.
Diffusore con elementi in lastra di
vetro curvata e acidata.



IP20

7,700 Kg / 0,1448 m³
E27 max 8 x 60W

€ 308

094014 Bianco

3000 K
900 lm

123899 € 7,70

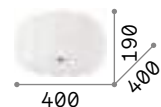

IP20

5,100 Kg / 0,1202 m³
E27 max 5 x 60W

€ 247,50

093963 Bianco

3000 K
900 lm

123899 € 7,70



P. 166



P. 358



Cloud **new**

Montatura ed elementi decorativi in metallo rifinito con vernice opaca. Diffusori in acrilico opale. Emissione luce indiretta. Colore: bianco.

LED Sorgente luminosa LED 3000 K, 17.500 h di durata.

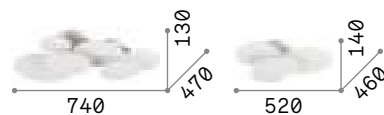

IP20

4,700 Kg / 0,0792 m³
LED 51W / 3150 lm

€ 302,50

285207 Bianco **new**

IP20

3,200 Kg / 0,0647 m³
LED 25W / 2000 lm

€ 203,50

263519 Bianco **new**



122205

122212

090863

Woody

Montatura in metallo cromato.
Diffusore in PVC o in tessuto,
chiuso sul fondo da vetro
trasparente acidato.



6,000 Kg / 0,1352 m³
E27 max 5 x 60W

€ 255,20

122205 ■ Bianco
122212 ■ Nero
090863 ■ Legno

3000 K
900 lm

123899 € 7,70

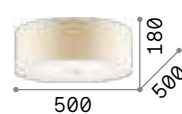

3,800 Kg / 0,0908 m³
E27 max 4 x 60W

€ 192,50

103266 ■ Bianco
103273 ■ Nero
090900 ■ Legno

3000 K
900 lm

123899 € 7,70



P. 184



P. 409

Wheel

Base e telaio in metallo smaltato.
Paralume in lamina di PVC ignifugo,
rivestita di tessuto.

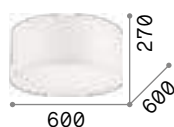

3,890 Kg / 0,1270 m³
E27 max 5 x 60W

€ 246,40

036021 Bianco

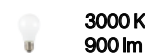

123899 € 7,70

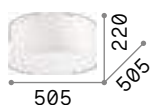

2,280 Kg / 0,0758 m³
E27 max 3 x 60W

€ 127,60

036014 Bianco

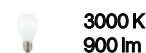

123899 € 7,70



P. 186



Ritz

Base in metallo smaltato. Paralume
e pannello diffusore inferiore in
lamina di PVC rivestita di tessuto.

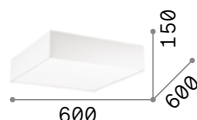

1,710 Kg / 0,0968 m³
E27 max 4 x 60W

€ 237,60

152912 Bianco

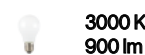

123899 € 7,70

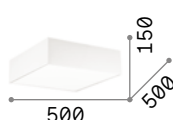

1,480 Kg / 0,0700 m³
E27 max 4 x 60W

€ 189,20

152899 Bianco

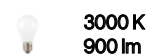

123899 € 7,70

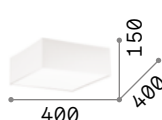

1,110 Kg / 0,0444 m³
E27 max 4 x 52W

€ 147,40

152875 Bianco

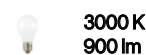

123899 € 7,70



Simply

Diffusore in vetro trasparente sabbato. Ganci ferma vetro in metallo cromato con sistema di bloccaggio a molla.

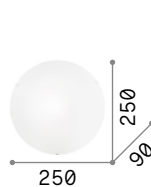
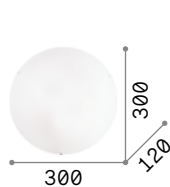
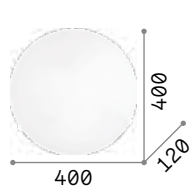
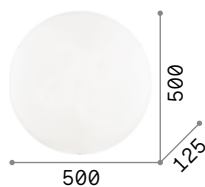

3,190 Kg / 0,0487 m³

E27 max 4 x 60W

€ 82,50

007991 Bianco

1,670 Kg / 0,0284 m³

E27 max 3 x 60W

€ 53,90

007984 Bianco

1,010 Kg / 0,0172 m³

E27 max 2 x 60W

€ 36,30

007977 Bianco

0,670 Kg / 0,0131 m³

E27 max 1 x 60W

€ 27,50

007960 Bianco

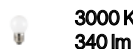

3000 K
340 lm

101286 € 3,30

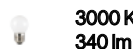

3000 K
340 lm

101286 € 3,30

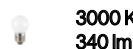

3000 K
340 lm

101286 € 3,30

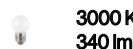

3000 K
340 lm

101286 € 3,30

Lana

Diffusore in vetro trasparente con decorazioni serigrafate all'interno e sabbato all'esterno. Ganci ferma vetro in metallo cromato.

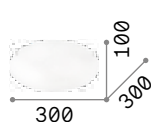
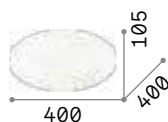

1,500 Kg / 0,0279 m³

E27 max 3 x 60W

€ 67,10

068145 Bianco

0,800 Kg / 0,0168 m³

E27 max 2 x 60W

€ 45,10

068138 Bianco

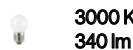

3000 K
340 lm

101286 € 3,30

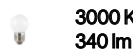

3000 K
340 lm

101286 € 3,30



P. 144

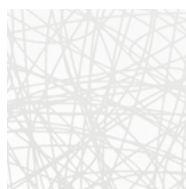

Dony

Diffusore in vetro trasparente soffiato ed acidato. Decorazioni serigrafate in bianco. Ganci ferma vetro in metallo cromato.

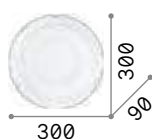

1,880 Kg / 0,0389 m³
E27 max 3x60W

1,100 Kg / 0,0179 m³
E27 max 2x60W

€ 64,90

€ 42,90

019635 Bianco

020891 Bianco

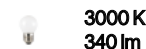
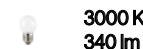

101286 € 3,30

101286 € 3,30

Shell

Diffusore di vetro trasparente lavorato in piastra e decorato all'interno con graniglia. Blocca vetro con dettaglio in metallo. Disponibile trasparente con dettaglio cromato o ambra con dettaglio ottonato.

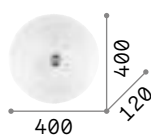
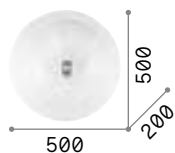
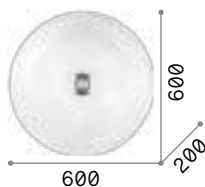

8,850 Kg / 0,0943 m³
E27 max 6x60W

6,150 Kg / 0,0647 m³
E27 max 4x60W

3,940 Kg / 0,0381 m³
E27 max 3x60W

€ 287,10

€ 207,90

€ 134,20

008622 Trasparen.
140193 Ambra

008615 Trasparen.
140186 Ambra

008608 Trasparen.
140179 Ambra

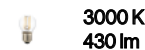
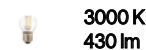
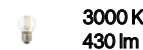

101279 € 3,30

101279 € 3,30

101279 € 3,30



008622

140193

Gemma

Base in plastica con varie finiture.
Diffusore in policarbonato bianco opaco.
Sistema di fissaggio rapido.

LED Sorgente luminosa LED 3000 K,
20.000 h di durata.

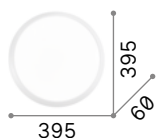

■ ■ □ IP20

0,760 Kg / 0,0275 m³
LED 24W / 2880 lm

€ 45,10

252612 ■ Bianco
252629 ■ Nero

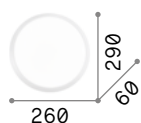

■ ■ □ IP20

0,430 Kg / 0,0164 m³
LED 12W / 1440 lm

€ 34,10

252599 ■ Bianco
252605 ■ Nero

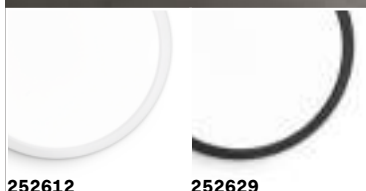

252612

252629

Ring

Montatura in metallo cromato.
Diffusore in vetro bianco soffiato e
acidato con fissaggio a baionetta.



■ ■ □ IP20

2,020 Kg / 0,0370 m³
E27 max 3 x 60W

€ 130,90

045733 ■ Bianco

101286 ■ 3000 K
340 lm

€ 3,30

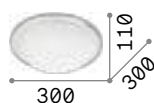

■ ■ □ IP20

1,220 Kg / 0,0217 m³
E27 max 2 x 60W

€ 96,80

045726 ■ Bianco

101286 ■ 3000 K
340 lm

€ 3,30





Lika Surface

Famiglia di moduli LED rettangolari in alluminio pressofuso, verniciato nero o bianco con riflettore in policarbonato. Moduli disponibili con cinque lenti. Appositamente disegnato per evitare abbagliamenti (UGR<16), trova la sua migliore collocazione all'interno di UFFICI e spazi COMMERCIALI.

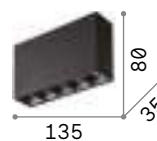

IP20

0,370 Kg / 0,0011 m³
LED 12,5W / 1100/1250 lm

€ 90,20

248530	Bianco	3000K
267838	Bianco	4000K
244884	Nero	3000K
267821	Nero	4000K



Sorgente luminosa LED 3000/4000 K,
30.000 h di durata.



P. 666



233079



233062



285214

Look ^{new}

Base di fissaggio in alluminio tornito. Diffusore cilindrico in metallo verniciato a polveri bianco o nero oppure in ottone satinato.

LED

Lampadine LED GU10 5W 3000 K incluse. Cod. **108292**

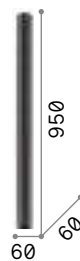

3,070 Kg / 0,0061 m³
GU10 max 1x28W

€ 85,80

259260 ■ Bianco ^{new}
259277 ■ Nero ^{new}



3000 K
480 lm

108292 € 4,95



1,380 Kg / 0,0037 m³
GU10 max 1x28W

€ 68,20

233352 ■ Bianco
233321 ■ Nero



3000 K
480 lm

108292 € 4,95

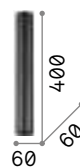

0,740 Kg / 0,0025 m³
GU10 max 1x28W

€ 56,10

233215 ■ Bianco
233192 ■ Nero



3000 K
480 lm

108292 € 4,95

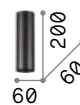

0,400 Kg / 0,0013 m³
GU10 max 1x28W

€ 45,10

233079 ■ Bianco
233062 ■ Nero
285214 ■ OttoneSat. ^{new}



3000 K
480 lm

108292 € 4,95



P. 070



P. 357



P. 603



Sky ^{new}

Corpo luce diffusore in metallo verniciato a polveri con finitura bianca o nera oppure in ottone satinato. Sistema di fissaggio senza viti a vista.

LED Lampadine LED GU10 5W 3000 K incluse. Cod. **108292**





P. 073



P. 356







IP20  
1,940 Kg / 0,0047 m³
GU10 max 1x28W
€ 101,20

234007  Bianco
 233970  Nero

 **3000 K**
480 lm
108292 € 4,95





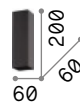

IP20  
1,090 Kg / 0,0027 m³
GU10 max 1x28W
€ 90,20

233833  Bianco
 233826  Nero

 **3000 K**
480 lm
108292 € 4,95



IP20  
0,600 Kg / 0,0016 m³
GU10 max 1x28W
€ 71,50

233772  Bianco
 233765  Nero
 285221  **Ottone Sat. ^{new}**

 **3000 K**
480 lm
108292 € 4,95



Nitro

Corpo luce in alluminio verniciato bianco o nero opachi. Interno rifinito con mascherina in plastica. Sorgente luminosa a led integrato con lente.

LED Sorgente luminosa LED 3000 K, 30.000 h di durata.



206035

206042



IP20

0,910 Kg / 0,0030 m³
LED 15W / 1350 lm

€ 86,90

205977 ■ Bianco
205984 ■ Nero

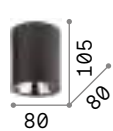

IP20

0,390 Kg / 0,0013 m³
LED 10W / 900 lm

€ 63,80

205991 ■ Bianco
206004 ■ Nero



IP20

0,400 Kg / 0,0013 m³
LED 15W / 1350 lm

€ 86,90

206011 ■ Bianco
206028 ■ Nero

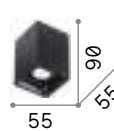

IP20

0,230 Kg / 0,0005 m³
LED 10W / 900 lm

€ 63,80

206035 ■ Bianco
206042 ■ Nero



Mood

Corpo luce in metallo disponibile con sezione quadra o tonda. Nero all'interno e bianco o nero all'esterno. Diffusore interno orientabile.

 Lampadine alogene GU10 28W e GU10 50W 2700 K incluse.



140841



243924

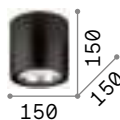

1,210 Kg / 0,0061 m³
GU10 max 1x 50W

€ 96,80

140872  Bianco
243450  Nero

 3000 K
950 lm

189031 € 16,50



0,400 Kg / 0,0022 m³
GU10 max 1x 28W

€ 63,80

140841  Bianco
243924  Nero

 3000 K
480 lm

108292 € 4,95

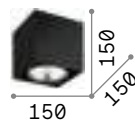

1,420 Kg / 0,0068 m³
GU10 max 1x 50W

€ 96,80

140933  Bianco
243931  Nero

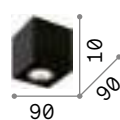

 3000 K
950 lm

189031 € 16,50



0,460 Kg / 0,0023 m³
GU10 max 1x 28W

€ 63,80

140902  Bianco
243948  Nero

 3000 K
480 lm

108292 € 4,95



Oak

Corpo luce in gesso o cemento.
Elemento portalampada centrale orientabile in metallo verniciato.



Articolo adatto alla pittura e verniciatura.

150475



150420

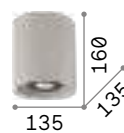

1,730 Kg / 0,0082 m³
GU10 max 1x 35W

€ 75,90

150420 ■ Bianco
150437 ■ Cemento

 3000 K
480 lm

108292 € 4,95

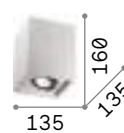

2,210 Kg / 0,0078 m³
GU10 max 1x 35W

€ 75,90

150468 ■ Bianco
150475 ■ Cemento

 3000 K
480 lm

108292 € 4,95



P. 072

Tower

Base di fissaggio in materiale plastico con sistema a baionetta.
Corpo luce interamente in gesso.
Monta lampadine GU10 sostituibili.



Articolo adatto alla pittura e verniciatura.



0,430 Kg / 0,0023 m³
GU10 max 1x 35W

€ 38,50

155869 Bianco

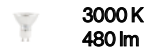

108292 € 4,95



0,620 Kg / 0,0023 m³
GU10 max 1x 35W

€ 38,50

155791 Bianco

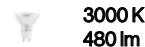

108292 € 4,95



Spike ^{new}

Corpo luce e base in alluminio tornito verniciato a polveri o placcato. Sorgente luminosa a led sostituibile. Colori: bianco, nero oppure ottone satinato.



Lampadine LED GX53 9W 3000 K incluse. Cod. **123936**

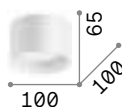

0,240 Kg / 0,0017 m³
GX53 max 1x 15W

€ 77

277417 Bianco ^{new}

278704 Nero ^{new}

285238 Ottone Sat. ^{new}

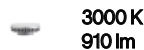

123936 € 7,15





Dynamite

Montatura in metallo rifinito con vernice a polveri o placcato e spazzolato. Diffusori orientabili.

LED Lampadine LED GU10 5W 3000 K incluse. Cod.108292



0,430 Kg / 0,0037 m³
GU10 max 1x28W

€ 96,80

231495 ■ Bianco
231471 ■ Nero
244662 ■ OttoneSat.

3000 K
480 lm

108292 € 4,95



P. 084

Play

Base, snodo e corpo luce orientabile in alluminio pressofuso verniciato a polveri. Diffusore in acrilico trasparente zigrinato. Disponibile nelle finiture nero oppure bianco con cover posteriore e ghiera frontale interni neri.

LED Sorgente luminosa LED 3000 K, 50.000 h di durata.

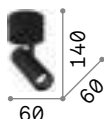

IP20

0,240 Kg / 0,0010 m³
LED 7W / 520 lm

€ 80,30

258287 **Bianco**
268101 **Nero**

P. 660



Toby ^{new}

Montatura in alluminio pressofuso verniciato a polveri. Diffusori orientabili in rotazione e inclinazione. Colori: bianco o nero.

LED Lampadine LED GU10 5W 3000 K incluse. Cod.108292

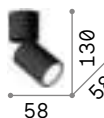

IP20

0,220 Kg / 0,0008 m³
GU10 max 1x 35W

€ 49,50

271538 **Bianco** ^{new}
271545 **Nero** ^{new}

3000 K
480 lm

108292 € 4,95





Petit

Corpo luce in metallo placcato o verniciato opaco. Sistema di fissaggio senza viti a vista. Disponibile con finitura bianca, cromo, ottone e nero.

LED Lampadine LED E27 8W Globo D95 3000 K include. Cod. **101330**



232966

233017

232980

233031

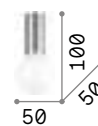

0,790 Kg / 0,0071 m³
E27 max 1x60W

€ 36,30

232966 Bianco
233017 Cromo
232980 Nero
233031 OttoneSat.

3000 K
950 lm
101330 € 8,80



Winery

Corpo luce con portalampane incorporato interamente in ceramica con finitura in smalto lucido bianco o nero.



155227



155142

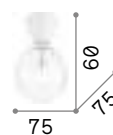

IP20

0,290 Kg / 0,0004 m³
E27 max 1x60W

€ 23,10

155227 ■ Bianco
155142 ■ Nero

3000 K
1120 lm

101323 € 8,25



Mouse

Base, montatura e diffusori in metallo rifinito con vernice opaca e dettagli in cromo. Diffusori orientabili. Disponibile nelle finiture bianco o nero.

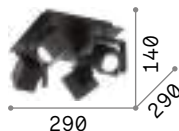

■ □ ⊕ IP20

1,900 Kg / 0,0157 m³
GU10 max 4 x 50W

€ 258,50

073583 ■ Bianco
156712 ■ Nero



108292 € 4,95



P. 384



P. 602



073583

156712

Spot

Base, montatura e diffusori in metallo rifinito con vernice opaca e dettagli in cromo. Diffusori orientabili. Disponibile nelle finiture bianco o nero.



■ □ ⊕ IP20

1,320 Kg / 0,0139 m³
GU10 max 4 x 50W

€ 99

156774 ■ Bianco
156781 ■ Nero

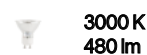

108292 € 4,95



P. 384



P. 602



156774

156781

Rudy

Montatura in alluminio pressofuso verniciato a polveri bianco o nero. Diffusori orientabili in rotazione e inclinazione.

LED Lampadine LED GU10 5W 3000 K incluse. Cod. **108292**

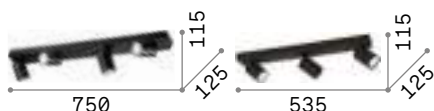

1,230 Kg / 0,0057 m³
GU10 max 4 x 35W

€ 181,50

229089 Bianco
229072 Nero

1,080 Kg / 0,0041 m³
GU10 max 3 x 35W

€ 126,50

229065 Bianco
229058 Nero

3000 K
480 lm

108292 € 4,95

3000 K
480 lm

108292 € 4,95

P. 385



Oby

Montatura in metallo verniciato bianco opaco, con snodi cromati. Corpo luce orientabile con diffusore in materiale plastico bianco.

LED Sorgente luminosa LED 3000 K, 20.000 h di durata.



1,210 Kg / 0,0058 m³
LED 24W / 2200 lm

€ 258,50

196718 Bianco



0,870 Kg / 0,0038 m³
LED 18W / 1650 lm

€ 181,50

196701 Bianco



P. 386





Glim

Montatura interamente in metallo verniciato a polveri di colore bianco o nero. Diffusore orientabile con lampadina sostituibile.

LED Lampadine LED GU10 13W 3000 K incluse. Cod. **189031**

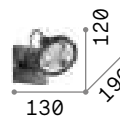
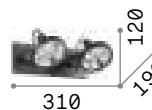
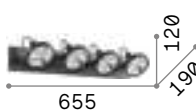
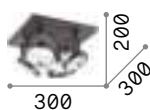

1,850 Kg / 0,0228 m³
GU10 max 4 x 50W

1,270 Kg / 0,0202 m³
GU10 max 4 x 50W

0,890 Kg / 0,0074 m³
GU10 max 2 x 50W

0,480 Kg / 0,0034 m³
GU10 max 1 x 50W

€ 280,50

€ 258,50

€ 137,50

€ 71,50

229638 ■ Bianco
229645 ■ Nero

200217 ■ Bianco
200255 ■ Nero

200200 ■ Bianco
200248 ■ Nero

200194 ■ Bianco
200231 ■ Nero

3000 K
950 lm

3000 K
950 lm

3000 K
950 lm

3000 K
950 lm

189031 € 16,50

189031 € 16,50

189031 € 16,50

189031 € 16,50



Alfa ^{new}

Montatura in metallo con finitura in cromo, bianco satinato, nickel satinato od ottone satinato. Corpo luce posizionabile con rotazione dello stelo e snodo per l'inclinazione.

LED Lampadine LED GU10 5W 3000 K incluse. Cod. **108292**

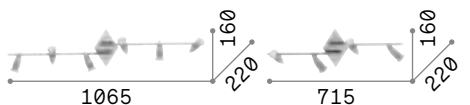

1,140 Kg / 0,0196 m³
GU10 max 6 x 50W

€ 132

122748 Bianco
089591 Cromo
006338 Nickel
287805 OttoneSat.

1,070 Kg / 0,0158 m³
GU10 max 4 x 50W

€ 88

122731 Bianco
089584 Cromo
006321 Nickel
new 287799 OttoneSat. new

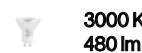

108292 € 4,95

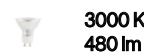

108292 € 4,95



P. 387



122731

089584

006321

287799

Slem ^{new}

Montatura in metallo con finitura in bianco, cromo, nickel satinato od ottone satinato. Corpo luce posizionabile con rotazione dello stelo e snodo per l'inclinazione.

LED Lampadine LED GU10 5W 3000 K incluse. Cod. **108292**

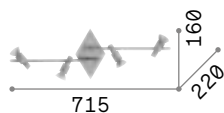

1,070 Kg / 0,0152 m³
GU10 max 4 x 50W

€ 88

142098 Bianco
142067 Cromo
018850 Nickel
287812 OttoneSat. new

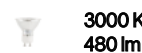

108292 € 4,95



P. 387



142098

142067

018850

287812



Maracas ^{new}

Montatura interamente in metallo rifinito in bianco od ottone satinato. Diffusori orientabili in vetro soffiato trasparente.

LED Lampadine LED G4 2W 3000 K incluse.
Cod. 222257



200392



200354

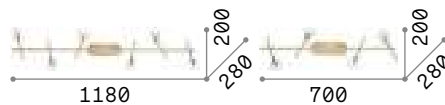

IP20

1,280 Kg / 0,0242 m³
G4 max 6 x 2W

€ 374

200408 **Bianco** ^{new}
200361 **Ottone**

3000 K
170 lm

222257 € 4,95

IP20

0,960 Kg / 0,0142 m³
G4 max 4 x 2W

€ 268,40

200392 **Bianco** ^{new}
200354 **Ottone**

3000 K
170 lm

222257 € 4,95



P. 398

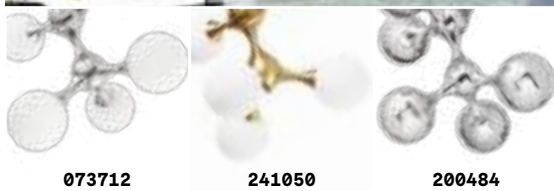

073712

241050

200484

Nodi

Montatura in metallo cromato oppure in ottone satinato. Diffusori in vetro bianco soffiato, acidato o trasparente e cromato.

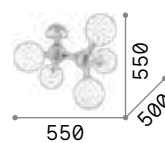

IP20

3,200 Kg / 0,1012 m³
E14 max 5 x 40W

€ 207,90

073712 ■ Bianco
241050 ■ OttoneSat.

101200 3000 K
480 lm € 3,30

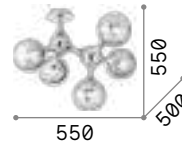

IP20

3,200 Kg / 0,1012 m³
E14 max 5 x 40W

€ 346,50

200484 ■ Cromo

101200 3000 K
480 lm € 3,30



P. 165



P. 396

Nodino

Montatura in metallo con finitura in cromo o in vernice opaca bianca. Diffusori in vetro bianco soffiato e acidato.

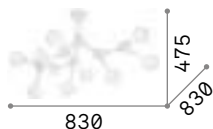

LED Lampadine LED G9 3W 3000 K incluse.
Cod. **209043**



IP20 

3,160 Kg / 0,3975 m³
G9 max 9 x 15W

€ 534,60

149622  Bianco
133393  Cromo

 3000 K
370 lm

209043 € 4,29



Nodi Crystal

Montatura in metallo cromato. Diffusori composti da anelli in metallo cromato con ottagononi di cristallo incastonati all'interno.

 Lampadine alogene G9 28W 2700 K incluse.

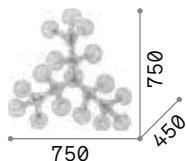

IP20 

5,000 Kg / 0,2422 m³
G9 max 15 x 40W

€ 983,40

093512  Cromo

 3000 K
370 lm

209043 € 4,29

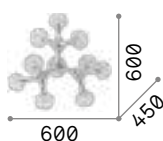

IP20 

3,400 Kg / 0,1012 m³
G9 max 9 x 40W

€ 531,30

093505  Cromo

 3000 K
370 lm

209043 € 4,29



Triumph

Base, bracci e copri porta lampade in metallo con finitura nero opaco o ottone invecchiato.

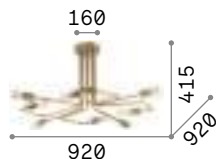

■ IP20

3,270 Kg / 0,0454 m³
E27 max 8 x 60W

€ 544,50

242378 ■ Nero
160313 ■ Ottone

2200 K
370 lm

151687

€ 6,05



P. 086

P. 398



242378

160313

Plumber

Montatura con elementi idraulici in metallo. Rifinito con vernice opaca nera.

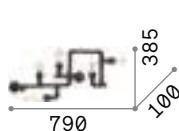
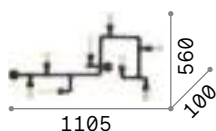

■ IP20

5,570 Kg / 0,1076 m³
E27 max 8 x 42W

€ 407

136714 ■ Nero

2200 K
370 lm

151687

€ 6,05

■ IP20

4,180 Kg / 0,0504 m³
E27 max 5 x 42W

€ 281,60

136707 ■ Nero

2200 K
370 lm

151687

€ 6,05





Birds new

Montatura in metallo verniciato con disco decorativo in ottone satinato. Diffusori in vetro soffiato bianco acidato. Colore: nero opaco con dettaglio ottone satinato.



Lampadine LED G9 3W 3000 K incluse.
Cod. **209043**



P. 090



P. 395



P. 446



P. 472

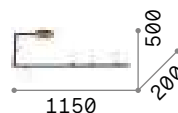

2,800 Kg / 0,1535 m³
G9 max 5 x 15W

€ 269,50

273631 ■ Nero new

3000 K
370 lm

209043

€ 4,29

Dea

Montatura a semi-sfera e copri porta lampade in metallo cromato. Lampade a LED sostituibili.

LED

Lampadine LED E27 2W Globo D125 trasparente 3000 K incluse.
Cod. **184470**

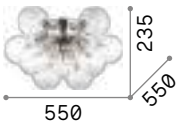

3,300 Kg / 0,0777 m³
E27 max 10 x 20W

€ 335,50

074740 **Cromo**

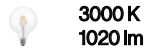

101347 **€ 9,35**

Pauline

Montatura in metallo cromato. Elementi decorativi in vetro trasparente modellato a mano e cromato.

LED

Lampadine LED G9 3W 3000 K incluse.
Cod. **209043**

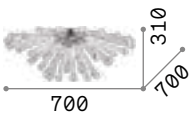

3,500 Kg / 0,0380 m³
G9 max 5 x 40W

€ 482,90

111117 **Fumè**

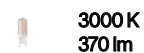

209043 **€ 4,29**



P. 096

Multiflex

Montatura in metallo rifinito con vernice opaca. Bracci flessibili metallici, rivestiti in gomma.

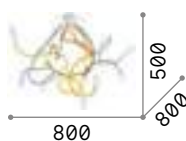

IP20

4,330 Kg / 0,0353 m³

E14 max 8 x 40W

€ 399,30

159010 Color

3000 K
420 lm

101217 € 3,30



P. 169



Octopus

Base in metallo rifinito opaco. Bracci flessibili rivestiti di gomma di colore bianco o multicolor. Diffusori in vetro trasparente soffiato e sabbato.



Lampadine alogene G9 28W 2700 K incluse.

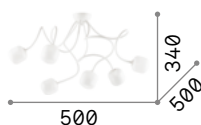

IP20

3,000 Kg / 0,0390 m³

G9 max 6 x 28W

€ 338,80

174921 Bianco

174976 Color

3000 K
370 lm

209043 € 4,29



174921

174976



Spark

Montatura in metallo verniciato
nero opaco con portalampane
placcati.

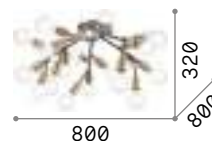

■ □ IP20

2,730 Kg / 0,0864 m³
E27 max 20 x 25W

€ 415,80

238333 ■ Nero

💡 3000 K
1120 lm

101323 € 8,25



P. 095



Cosmopolitan new

Montatura in metallo rifinito con vernice opaca. Diffusori in vetro soffiato bianco acidato. Colori: tutto bianco o nero con dettagli ottone satinato.



Lampadine LED G9 3W 3000 K incluse.
Cod. 209043



285245



273693

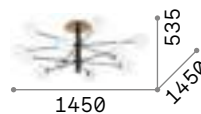

IP20 INCLUSA

7,600 Kg / 0,1787 m³
G9 max 12 x 15W

€ 660

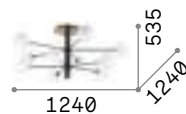

IP20 INCLUSA

6,500 Kg / 0,1397 m³
G9 max 10 x 15W

€ 577,50

285252 Bianco new 285245 Bianco new
273709 Nero new 273693 Nero new

3000 K
370 lm
209043 € 4,29

3000 K
370 lm
209043 € 4,29



Lingotto

Montatura in metallo verniciato: base nera opaca e telaio ottone opaco. Diffusori in vetro incamiciato bianco, soffiato e acidato.



■ IP20

5,580 Kg / 0,0540 m³
E14 max 4 x 40W

€ 301,40

198156 Ottone

3000 K
420 lm

101217 € 3,30

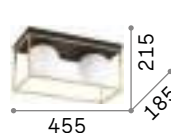

■ IP20

3,370 Kg / 0,0451 m³
E14 max 2 x 40W

€ 201,30

198149 Ottone

3000 K
420 lm

101217 € 3,30

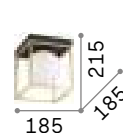

■ IP20

1,810 Kg / 0,0183 m³
E14 max 1 x 40W

€ 125,40

198132 Ottone

3000 K
420 lm

101217 € 3,30



P. 088



P. 447

Almond

Montatura in metallo verniciato bianco opaco. Elementi diffusori in vetro soffiato bianco incamiciato e acidato.

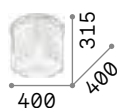

IP20

IP20

26,390 Kg / 0,3100 m³
E27 max 9 x 60W

7,610 Kg / 0,1048 m³
E27 max 3 x 60W

€ 675,40

€ 337,70

159645 Bianco

159638 Bianco

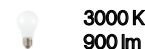

123899 € 7,70

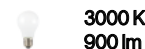

123899 € 7,70



Daisy

Base in metallo rifinita con foglia oro. Diffusori in vetro soffiato bianco, acidato e con rigatura in rilievo.

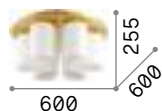

IP20

12,000 Kg / 0,1711 m³
E27 max 6 x 60W

€ 435,60

247779 Oro

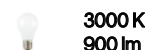

123899 € 7,70





Compo

Montatura in metallo cromato o verniciato bianco opaco. Elementi diffusori in vetro soffiato bianco incamiciato e acidato o trasparente fumè.



125503



172828

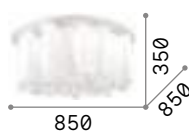

IP20

25,620 Kg / 0,5084 m³
E27 max 15 x 60W

€ 1375

125565 Bianco

3000 K
910 lm

119571 € 7,70



IP20

17,200 Kg / 0,3008 m³
E27 max 10 x 60W

€ 1017,50

125510 Bianco
172804 Fumè

3000 K
910 lm

119571 € 7,70

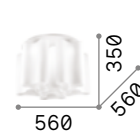

IP20

9,900 Kg / 0,1918 m³
E27 max 6 x 60W

€ 550

125503 Bianco
172828 Fumè

3000 K
910 lm

119571 € 7,70



Roma

Montatura e dettagli in metallo cromato. Diffusore con elementi quadrati in cristallo molato sulla fascia laterale e vetro sabbato sul fondo.

LED Lampadine LED G9 3W 3000 K incluse.
Cod. 209043

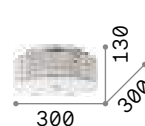
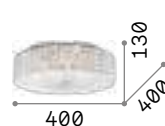
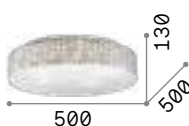
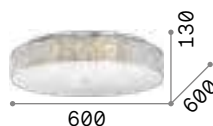

9,600 Kg / 0,1220 m³
G9 max 12 x 40W

6,800 Kg / 0,0905 m³
G9 max 9 x 40W

4,800 Kg / 0,0588 m³
G9 max 6 x 40W

2,500 Kg / 0,0390 m³
G9 max 4 x 40W

€ 605

€ 543,40

€ 380,60

€ 260,70

087870 || Cromo

087863 || Cromo

000657 || Cromo

093093 || Cromo

3000 K
370 lm

3000 K
370 lm

3000 K
370 lm

3000 K
370 lm

209043 € 4,29

209043 € 4,29

209043 € 4,29

209043 € 4,29



P. 199

P. 414

P. 462



Pashà

Montatura in metallo. Diffusore composto da filari di perle in cristallo molato e fondo chiuso da vetro circolare sabbato.



164991



165004



P. 201

P. 414



IP20

13,000 Kg / 0,1809 m³
E14 max 14 x 40W

€ 1144

164991 || Cromo
165004 || Oro

3000 K
480 lm

101200 € 3,30



IP20

8,800 Kg / 0,1040 m³
E14 max 10 x 40W

€ 979

100746 || Cromo
100791 || Oro

3000 K
480 lm

101200 € 3,30

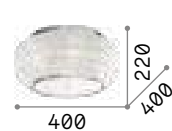

IP20

6,200 Kg / 0,0529 m³
E14 max 6 x 40W

€ 781

100784 || Cromo
100807 || Oro

3000 K
480 lm

101200 € 3,30



King

Diffusore composto da anelli in metallo cromato o dorato con ottagononi di cristallo incastonati all'interno.

LED

Lampadine LED G9 3W 3000 K incluse.
Cod. **209043**



073255



073262



P. 193

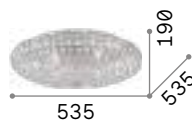

6,250 Kg / 0,0946 m³
G9 max 9 x 40W

€ 645,70

073255 || Cromo
073262 || Oro

3000 K
370 lm

209043 € 4,29

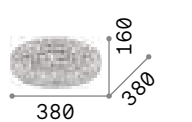

3,200 Kg / 0,0487 m³
G9 max 5 x 40W

€ 368,50

075419 || Cromo
073187 || Oro

3000 K
370 lm

209043 € 4,29

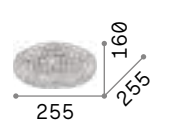

1,750 Kg / 0,0240 m³
G9 max 3 x 40W

€ 213,40

075389 || Cromo
075402 || Oro

3000 K
370 lm

209043 € 4,29

Virgin

Montatura in metallo cromato.
Elementi decorativi di cristallo
molato in forma di perle e quadrati
di varie misure.

LED Lampadine LED G9 3W 3000 K incluse.
Cod. **209043**

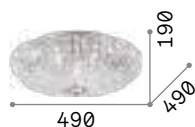

6,100 Kg / 0,0721 m³
G9 max 6 x 40W

€ 573,10

016122 Cromo

3000 K
370 lm

209043 € 4,29

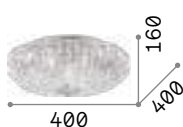

3,700 Kg / 0,0470 m³
G9 max 5 x 40W

€ 404,80

018089 Cromo

3000 K
370 lm

209043 € 4,29

Orion

Diffusore composto da anelli in
metallo cromato con ottagoni di
cristallo incastonati all'interno.

LED Lampadine LED G9 3W 3000 K incluse.
Cod. **209043**

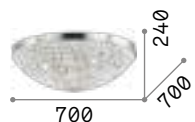

9,500 Kg / 0,1879 m³
G9 max 12 x 40W

€ 974,60

059129 Cromo

3000 K
370 lm

209043 € 4,29

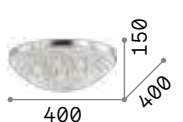

3,250 Kg / 0,0451 m³
G9 max 5 x 40W

€ 280,50

059143 Cromo

3000 K
370 lm

209043 € 4,29

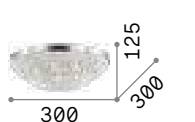

1,950 Kg / 0,0282 m³
G9 max 3 x 40W

€ 157,30

059136 Cromo

3000 K
370 lm

209043 € 4,29



P. 192



Quadro

Base quadrata ed elementi porta lampade in metallo cromato. Corpo luce cubico con facciate di reticolo a maglia larga con spessore di 2,5 mm in fusione d'alluminio.

LED

Lampadine LED G9 3W 3000 K incluse.
Cod. **209043**

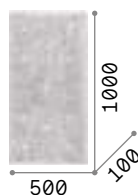

9,900 Kg / 0,1097 m³
G9 max 11 x 40W

€ 720,50

036045 ■ Alluminio

3000 K
370 lm

209043 € 4,29

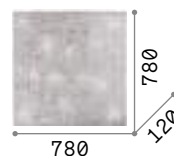

13,750 Kg / 0,1309 m³
G9 max 12 x 40W

€ 869

031651 ■ Alluminio

3000 K
370 lm

209043 € 4,29

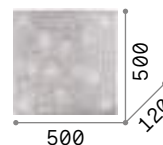

6,840 Kg / 0,0564 m³
G9 max 8 x 40W

€ 495

031668 ■ Alluminio

3000 K
370 lm

209043 € 4,29



Admiral

Diffusore composto da anelli in metallo saldati tra loro e da elementi in cristallo molato incastonati all'interno.

LED Lampadine LED G9 3W 3000 K incluse.
Cod. 209043

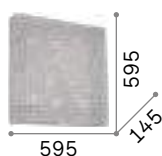

IP20 INCLUSA

8,490 Kg / 0,1000 m³
G9 max 10 x 40W

€ 917,40

080291 || Cromo

3000 K
370 lm

209043 € 4,29

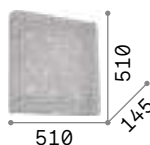

IP20 INCLUSA

7,050 Kg / 0,0731 m³
G9 max 8 x 40W

€ 742,50

080352 || Cromo

3000 K
370 lm

209043 € 4,29

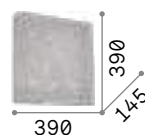

IP20 INCLUSA

4,580 Kg / 0,0486 m³
G9 max 6 x 40W

€ 496,10

080345 || Cromo

3000 K
370 lm

209043 € 4,29

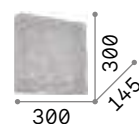

IP20 INCLUSA

3,000 Kg / 0,0318 m³
G9 max 4 x 40W

€ 336,60

080338 || Cromo

3000 K
370 lm

209043 € 4,29



101187

022239

Neve

Montatura in metallo. Elementi decorativi con sfere di vetro fissate a fili di nylon. Disponibile con montatura cromata e sfere trasparenti o con montatura in bianco opaco e sfere bianche e trasparenti.

LED

Lampadine LED G9 3W 3000 K incluse.
Cod. 209043

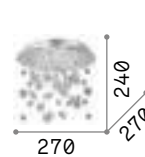
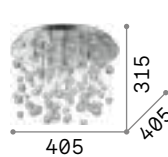
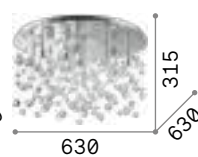
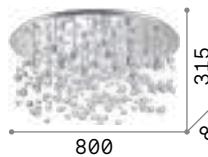

11,250 Kg / 0,1524 m³
G9 max 15 x 40W

7,420 Kg / 0,0920 m³
G9 max 12 x 40W

3,590 Kg / 0,0344 m³
G9 max 8 x 40W

1,500 Kg / 0,0149 m³
G9 max 5 x 40W

€ 731,50

€ 495

€ 291,50

€ 148,50

101194 Bianco
030784 Cromo

101187 Bianco
022239 Cromo

101170 Bianco
022222 Cromo

094687 Cromo

3000 K
370 lm

3000 K
370 lm

3000 K
370 lm

3000 K
370 lm

209043 € 4,29

209043 € 4,29

209043 € 4,29

209043 € 4,29



Moonlight

Montatura in metallo con finitura disponibile in cromo o dorato.
Pendagli con ottagononi e sfere in cristallo molato.

LED Lampadine LED G9 3W 3000 K incluse.
Cod. 209043

IP20	IP20	IP20	IP20
11,800 Kg / 0,1524 m ³ G9 max 15 x 40W	6,000 Kg / 0,0933 m ³ G9 max 12 x 40W	2,900 Kg / 0,0398 m ³ G9 max 8 x 40W	1,500 Kg / 0,0144 m ³ G9 max 5 x 40W
€ 874,50	€ 602,80	€ 337,70	€ 169,40
077819 Cromo 082790 Oro	077802 Cromo 082783 Oro	077796 Cromo 080932 Oro	094649 Cromo 094663 Oro
3000 K 370 lm	3000 K 370 lm	3000 K 370 lm	3000 K 370 lm
209043 € 4,29	209043 € 4,29	209043 € 4,29	209043 € 4,29











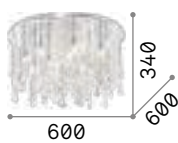
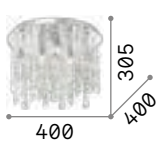

Royal

Montatura circolare e portalampane in metallo cromato. Pendagli con elementi in cristallo molato ottagonali, quadrati, rettangolari e gocce finali.

LED

Lampadine LED G9 3W 3000 K incluse.
Cod. 209043

		
800	600	400
 IP20 	 IP20 	 IP20 
9,830 Kg / 0,1491 m ³ G9 max 15 x 40W	5,900 Kg / 0,0881 m ³ G9 max 12 x 40W	2,840 Kg / 0,0379 m ³ G9 max 8 x 40W
€ 834,90	€ 588,50	€ 306,90
053011 Cromo	053004 Cromo	052991 Cromo
 3000 K 370 lm	 3000 K 370 lm	 3000 K 370 lm
209043 € 4,29	209043 € 4,29	209043 € 4,29



Bijoux

Montatura circolare e portalampane in metallo cromato. Elementi decorativi con catene di ottagoni e pendagli finali a sfera in cristallo molato.

LED

Lampadine LED G9 3W 3000 K incluse.
Cod. **209043**

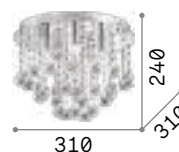

IP20

2,370 Kg / 0,0181 m³
G9 max 5 x 40W

€ 202,40

089485 Cromo

3000 K
370 lm

209043

€ 4,29



Magnolia

Montatura in metallo con finitura oro. Elementi decorativi in cristallo molato trasparente. Nella parte superiore si alternano elementi trasparenti ed elementi fumè.

LED

Lampadine LED G9 3W 3000 K incluse.
Cod. **209043**

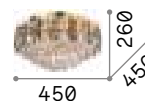

9,780 Kg / 0,0984 m³
G9 max 7 x 15W

€ 620,40

241296  Oro

 **3000 K**
370 lm

209043 € 4,29

Dubai

Montatura in metallo con finitura cromo o ottone. Elementi decorativi con perle, ottagoni e prismi in cristallo molato trasparente.



IP20

14,290 Kg / 0,4438 m³

E14 max 24 x 40W

€ 1375

243566 Cromo
243498 Ottone

3000 K
470 lm

101224 € 3,30

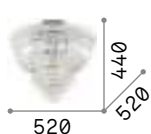

IP20

6,310 Kg / 0,2028 m³

E14 max 6 x 40W

€ 935

207186 Cromo
201016 Ottone

3000 K
470 lm

101224 € 3,30

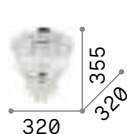

IP20

3,010 Kg / 0,0721 m³

E14 max 3 x 40W

€ 473

207162 Cromo
200996 Ottone

3000 K
470 lm

101224 € 3,30



207186



201016



P. 204



P. 415

Caesar

Montatura in metallo con finitura in oro o cromo. Elementi decorativi in cristallo molato ottagonali con finali a puntale.

LED Lampadine LED G9 3W 3000 K incluse.
Cod. 209043

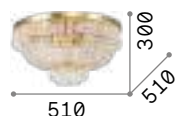

IP20

5,920 Kg / 0,0975 m³

G9 max 6 x 40W

€ 808,50

093475 Cromo
114682 Ottone

3000 K
370 lm

209043 € 4,29

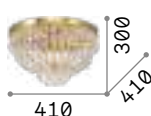

IP20

3,820 Kg / 0,0632 m³

G9 max 5 x 40W

€ 654,50

103792 Cromo
114675 Ottone

3000 K
370 lm

209043 € 4,29



P. 205



093475



114682

Rain

Montatura in metallo cromato.
Pendagli con elementi in cristallo
molato in varie forme e gocce finali.

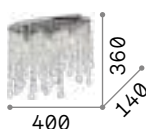
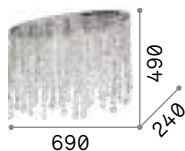

3,820 Kg / 0,0225 m³
E14 max 5 x 40W

1,800 Kg / 0,0094 m³
E14 max 3 x 40W

€ 335,50

€ 165

008455 || Cromo

008370 || Cromo

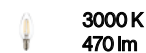
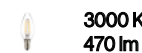

101224 € 3,30

101224 € 3,30



P. 194

P. 462

Martinez

Montatura in metallo cromato
o dorato. Elementi decorativi
con catene di ottagoni e barre in
cristallo molato trasparente.

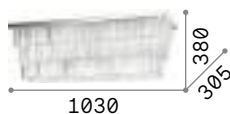

17,500 Kg / 0,0807 m³
E14 max 8 x 40W

€ 770

166285 || Cromo

213569 || Oro

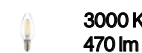

101224 € 3,30

P. 197



166285



213569



Carlton

Montatura in metallo cromato o dorato. Elementi decorativi con catene di ottoni e barre in cristallo molato trasparente.



168937



213507

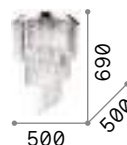

■ IP20

13,840 Kg / 0,1563 m³
E14 max 12 x 40W

€ 687,50

168937 Cromo
213507 Ottone

3000 K
470 lm
101224 € 3,30

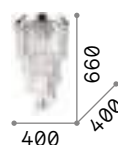

■ IP20

10,200 Kg / 0,1066 m³
E14 max 8 x 40W

€ 605

168920 Cromo

3000 K
470 lm
101224 € 3,30



P. 198

P. 415



Interni

Lampade da parete

Indice alfabetico

Alfa	387	Eclissi	405	Luxury	410	Retro'	372
Ali	362	Edison	391	Mapa Bianco	360	Riflesso	367
Alma	368	Elica	358	Maracas	398	Roma	414
Audi-B	361	Elis	386	Minimal	392	Rudy	385
Barber	388	Equinoxe	399	Mirror-10	371	Santa	423
Bean	378	Essence	364	Mirror-20	373	Scacchi	424
Birds	395	Fiocco	423	Moris	344	Set Up	406
Bob Mini	388	Firenze	420	Mouse	384	Sheraton	412
Bonjour	369	Fix	343	Negresco	418	Shower	401
Book	383	Flash	355	Newton	400	Sky	356
Bow	370	Flash Gesso	355	Nodi	396	Slem	387
Box	345	Flex	377	Nordik	410	Smarties	360
Bright	349	Florian	418	Oby	386	Snake	386
Calypso	414	Focus	374	Opera	416	Soda	359
Camerino	363	Foglio	343	Ovalino	358	Spot	384
Cantina	400	Frida	393	Oz	339	Stones	424
Carlton	415	Gea	413	Page	379	Strauss	419
Carrara	425	Gim	385	Pan	402	Sunrise	403
Chalet	420	Gioconda	419	Pasha'	414	Swan	416
Cico	373	Goose	376	Paul	358	Syntesi	338
Click	349	Harem	422	Pegaso	417	Tick	404
Clip	347	Hilton	408	Peggy	341	Tonic	359
Commodore	342	Holiday	412	Perlage	397	Triplo	361
Corte	417	Hotel	411	Peter	421	Triumph	398
Cover	340	Igor	394	Pipe	380	Tudor	363
Cube	348	Io	375	Posta	346	Vela	342
Denis	362	Kepler	396	Pouche	341	Virtus	348
Desk	350	Kool	354	Prive'	366	Winery	389
Double	373	Line	367	Probe	382	Woody	409
Dubai	415	Linus	351	Puzzle	345	Zig Zag	353
Dynamo	377	Lite	381	Radio	390		
Echo	352	Look	357	Read	382		

Essence

Pag 364



new



Syntesi 338



Oz 339



Cover 340



Puzzle 345



Box 345

new



Posta 346

new



Echo 352

new



Zig Zag 353



Kool 354



Soda 359



Tonic 359



Smarties 360

new



Essence 364



Privè 366



Line 367



Cico 373



Double 373



Focus 374



Lite 381



Probe 382



Read 382



Elis 386

new



Alfa 387

























































new



Slem 387





































Interni

Indice icone

						
Peggy 341	Pouche 341	Vela 342	Commodore 342	Fix 343	Foglio 343	Moris 344
						
Clip 347	Cube 348	Virtus 348	Click 349	Bright 349	Desk 350	Linus 351
						
Flash 355	FlashGesso 355	Sky 356	Look 357	Paul 358	Elica 358	Ovalino 358
						
MapaBianco 360	Tripla 361	Audi-B 361	Ali 362	Denis 362	Tudor 363	Camerino 363
						
Riflesso 367	Alma 368	Bonjour 369	Bow 370	Mirror-10 371	Retrò 372	Mirror-20 373
new 						new 
IO 375	Goose 376	Flex 377	Dynamo 377	Bean 378	Page 379	Pipe 380
						
Book 383	Mouse 384	Spot 384	Gim 385	Rudy 385	Oby 386	Snake 386
						
Barber 388	Bob Mini 388	Winery 389	Radio 390	Edison 391	Minimal 392	Frida 393

Interni

Indice icone

	new 			new 		new 
Igor 394	Birds 395	Nodi 396	Kepler 396	Perlage 397	Triumph 398	Maracas 398
						
Newton 400	Shower 401	Pan 402	Sunrise 403	Tick 404	Eclissi 405	Set Up 406
						
Luxury 410	Nordik 410	Hotel 411	Holiday 412	Sheraton 412	Gea 413	Calypso 414
						
Carlton 415	Dubai 415	Opera 416	Swan 416	Corte 417	Pegaso 417	Negresco 418
						
Strauss 419	Firenze 420	Chalet 420	Peter 421	Harem 422	Santa 423	Fiocco 423
						
Carrara 425						

Birds

Pag 395



Equinoxe 399



Cantina 400



Hilton 408



Woody 409



Roma 414



Pashà 414



Florian 418



Gioconda 418



Stones 424



Scacchi 424





Syntesi ^{new}

Struttura e corpo luce in alluminio verniciato a polveri. Diffusore orientabile con schermo in acrilico trasparente zigrinato. Colore: bianco o nero.

LED

Sorgente luminosa LED 3000 K, 50.000 h di durata.

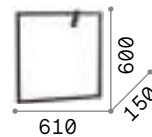

■ □ IP20

■ □ IP20

1,140 Kg / 0,0696 m³
LED 5W / 500 lm

0,200 Kg / 0,0047 m³
LED 3W / 300 lm

€ 495

€ 302,5

285276 ■ Bianco ^{new} 285269 ■ Bianco ^{new}
271897 ■ Nero ^{new} 271880 ■ Nero ^{new}



Oz

Base e montatura in metallo verniciato a polveri o placcato. Diffusore in gomma opale. Disponibile nelle finiture bianco, nero o ottone spazzolato.

LED Sorgente luminosa LED 3000 K, 30.000 h di durata.



269399



253695



269405

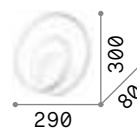

IP20

1,140 Kg / 0,0248 m³
LED 30W / 3000 lm

€ 187

253695 ■ Bianco
269399 ■ Nero
269405 ■ Ottone



P. 058

P. 259

P. 430



Cover

Corpo luce in alluminio verniciato a polveri di colore bianco o nero. Diffusore in materiale plastico opale. Sorgente luminosa a led integrati con emissione di luce riflessa.

LED

Sorgente luminosa LED 3000 K, 17.500 h di durata.

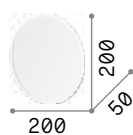

0,690 Kg / 0,0028 m³
LED 11W / 1100 lm

€ 99

195711 ■ Bianco
195759 ■ Nero

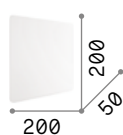

0,860 Kg / 0,0028 m³
LED 11W / 1100 lm

€ 99

195735 ■ Bianco
195773 ■ Nero

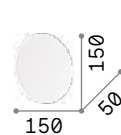

0,390 Kg / 0,0018 m³
LED 9,5W / 950 lm

€ 84,70

195704 ■ Bianco
195742 ■ Nero

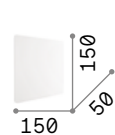

0,510 Kg / 0,0018 m³
LED 9,5W / 950 lm

€ 84,70

195728 ■ Bianco
195766 ■ Nero

Peggy

Base e montatura in metallo verniciato a polveri con finitura bianca. Diffusore in acrilico satinato. Emissione luce indiretta.

LED Sorgente luminosa LED 3000 K, 50.000 h di durata.

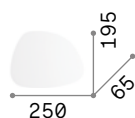

■ IP20

0,710 Kg / 0,0068 m³
LED 15W / 1980 Lm

€ 161,70

257242 Bianco

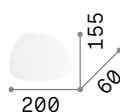

■ IP20

0,520 Kg / 0,0030 m³
LED 10,5W / 1240 Lm

€ 104,50

257235 Bianco



Pouche

Montatura in metallo rifinito con vernice a polveri di colore bianco. Diffusore in acrilico trasparente satinato. Emissione luce indiretta.

LED Sorgente luminosa LED 3000 K, 20.000 h di durata.

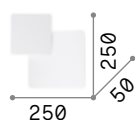

■ IP20

1,440 Kg / 0,0067 m³
LED 14W / 1300 Lm

€ 106,70

259352 Bianco

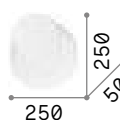

■ IP20

1,120 Kg / 0,0067 m³
LED 14W / 1300 Lm

€ 106,70

259345 Bianco



Vela

Base in metallo verniciato bianco opaco. Diffusore-dissipatore in lastra curva d'alluminio da 6 mm di spessore.

LED Sorgente luminosa LED 3000 K, 15.000 h di durata.



■ □ IP20

0,450 Kg / 0,0057 m³

LED 5W / 420 Lm

€ 91,30

090337 ■ Bianco



Commodore

Corpo luce interamente in metallo con finitura in vernice bianca opaca. Sorgente LED sostituibile.

LED Lampadine LED GX53 9W 3000 K incluse. Cod. **123936**

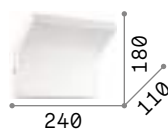

■ □ IP20  INCLUSA

1,170 Kg / 0,0069 m³
GX53 max 2 x 15W

€ 117,70

125923 ■ Bianco

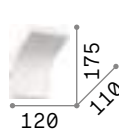

■ □ IP20  INCLUSA

0,640 Kg / 0,0034 m³
GX53 max 1 x 15W

€ 85,80

125886 ■ Bianco

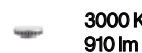

123936 € 7,15

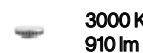

123936 € 7,15



Fix

Base in metallo con finitura bianca opaca. Diffusore-dissipatore in lastra d'alluminio da 6 mm di spessore. LED integrati.

LED Sorgente luminosa LED 3000 K, 20.000 h di durata.

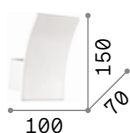

■ □ IP20

0,390 Kg / 0,0050 m³

LED 5W / 420 lm

€ 93,50

117867 ■ Bianco



Foglio

Articolo da incasso per finitura a scomparsa. Corpo luce interamente in gesso. Emette luce indiretta.

■ Articolo adatto alla pittura e verniciatura.

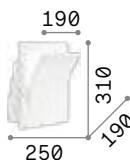

■ ⊕ IP20

4,000 Kg / 0,0292 m³

E14 max 1x 40W

€ 99

150581 ■ Bianco

● 3000 K
420 lm

101217 € 3,30





Moris

Montatura in metallo cromato.
Diffusore in vetro soffiato bianco.



Lampadine LED G9 3W 3000 K incluse.
Cod. **209043**

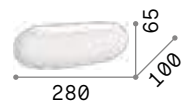

0,520 Kg / 0,0071 m³
G9 max 2x40W

€ 88

034546 Bianco

 **3000 K**
370 lm

209043 € 4,29

Puzzle

Montatura in metallo con finitura cromo. Diffusore in vetro soffiato bianco, incamiciato e acidato.

LED Lampadine LED G9 3W 3000 K incluse.
Cod. **209043**

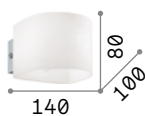

0,520 Kg / 0,0061 m³

G9 max 1x 40W

€ 55

035185 **Bianco**

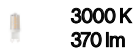

209043 € 4,29



Box

Montatura in metallo cromato. Diffusore in vetro soffiato, incamiciato e acidato. Bianco all'interno e colorato all'esterno.

LED Lampadine LED G9 3W 3000 K incluse.
Cod. **209043**

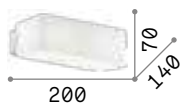

0,660 Kg / 0,0100 m³

G9 max 2 x 40W

€ 77

009537 **Bianco**

009513 **Nero**

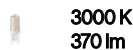

209043 € 4,29



009537

009513



051963

009940

051932

284729

Posta ^{new}

Corpo luce in metallo disponibile in alluminio spazzolato, in cromo, smaltato bianco o placcato ottone. Diffusore composto di tre vetri trasparenti smerigliati.

620	500	360
■ IP20	■ IP20	■ IP20
1,560 Kg / 0,0156 m³ E14 max 4 x 40W	1,270 Kg / 0,0136 m³ E14 max 3 x 40W	0,950 Kg / 0,0098 m³ E14 max 2 x 40W
€ 93,50	€ 82,50	€ 71,50
051987 Bianco 009957 Alluminio 051956 Cromo 288628 Ottone ^{new}	051970 Bianco 009933 Alluminio 051949 Cromo 288611 Ottone ^{new}	051963 Bianco 009940 Alluminio 051932 Cromo 284729 Ottone ^{new}
3000 K 480 lm	3000 K 480 lm	3000 K 480 lm
101200 € 3,30	101200 € 3,30	101200 € 3,30



Clip

Corpo luce interamente in lamina di metallo con varie finiture. Nella versione piccola, diffusori in vetro pirex sabbato.

LED

Lampadine LED G9 3W 3000 K incluse nei modelli: **049236**, **091136**, **049229**, **091129** e **170923**. Cod. **209043**

	014166		
	088273		
	031361		
	088266	1,210 Kg / 0,0161 m³ E27 max 2 x 60W	0,730 Kg / 0,0035 m³ G9 max 2 x 40W
	187365	€ 104,50	€ 93,50
		014166 Bianco	049236 Bianco
		088273 Argento	091136 Argento
		031361 Cromo	049229 Cromo
		088266 Oro	091129 Oro
		187365 Corten	170923 Corten
		3000 K 430 lm	3000 K 370 lm
		101279 € 3,30	209043 € 4,29

Cube

Corpoluce dissipatore interamente in lastra d'alluminio da 6 mm di spessore. Rifinito con vernice a polveri. LED integrati.

LED Sorgente luminosa LED 3000 K, 25.000 h di durata.

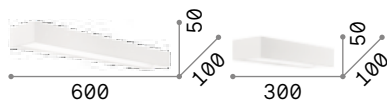

■ IP20

1,390 Kg / 0,0055 m³
LED 12W / 1200 lm

€ 192,50

161792 ■ Bianco

■ IP20

0,800 Kg / 0,0028 m³
LED 6W / 600 lm

€ 143

161785 ■ Bianco



Virtus

Montatura in metallo verniciato a polveri. Diffusore in acrilico satinato. Emissione luminosa diffusa, sopra, sotto e frontale. Colore: bianco.

LED Sorgente luminosa LED 3000/4000 K, 15.000 h di durata.

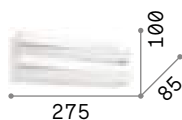

■ IP20

0,980 Kg / 0,0035 m³
LED 17W / 800/850 Lm

€ 110

267760 ■ Bianco 3000K
255989 ■ Bianco 4000K



Click

Corpo luce interamente in alluminio verniciato a polveri con finitura bianca. Struttura interna che riflette il fascio luminoso sia sopra che sotto.

LED Sorgente luminosa LED 3000 K, 20.000 h di durata.

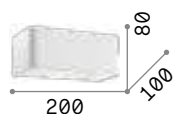

■ IP20

0,600 Kg / 0,0040 m³
LED 12W / 1200 lm

€ 82,50

017518 Bianco

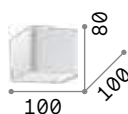

■ IP20

0,400 Kg / 0,0019 m³
LED 6W / 470 lm

€ 60,50

051444 Bianco



Bright

Corpo luce interamente in alluminio con finitura bianca. Fascio luminoso orientato sia verso l'alto che verso il basso.

LED Sorgente luminosa LED 3000 K, 30.000 h di durata.



■ IP20

1,660 Kg / 0,0101 m³
LED 22,5W / 1500 lm

€ 214,50

131962 Bianco

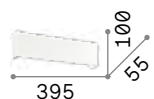

■ IP20

1,120 Kg / 0,0064 m³
LED 17W / 1100 lm

€ 159,50

134789 Bianco

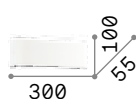

■ IP20

0,930 Kg / 0,0051 m³
LED 12W / 800 lm

€ 121

134796 Bianco





Desk

Corpo luce in alluminio verniciato a polveri con finitura bianca o nera. Diffusori in acrilico satinato. Emissione luce sopra e sotto.



Sorgente luminosa LED 3000 K, 30.000 h di durata.



138251



173252



IP20

0,640 Kg / 0,0045 m³
LED 12,5W / 740 lm

€ 140,80

138251 ■ Bianco
173252 ■ Nero



P. 078



Linus

Lampada lineare in alluminio con illuminazione diretta e indiretta per applicazione a parete. La lampada è modulare e può essere proposta singolarmente oppure in linea continua. È disponibile in finitura bianca o nera. LED integrati; binning iniziale ≤ 3-Step MacAdam; disponibile in temperatura di colore 3000 K e 4000 K; CRI ≥ 80; protezione IP20, classe isolamento I. Alimentatore dimmerabile 1-10V integrato di serie.

LED Sorgente luminosa LED 3000/4000 K, 50.000 h di durata.



P. 079

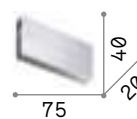
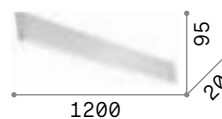

■ IP20

1,250 Kg / 0,0158 m³
LED 34W / 3850 lm

€ 209

233840	■ Bianco	3000K
268095	■ Bianco	4000K
242019	■ Nero	3000K
268071	■ Nero	4000K

Connector
Non incluso
Optional

€ 5,50

233666



273914

285283

285290

Echo ^{new}

Base e diffusore interamente in alluminio verniciato a polveri o placcato. Emissione luce indiretta. Colori: bianco, nero, ottone satinato.

LED

Sorgente luminosa LED 3000 K, 50.000 h di durata.

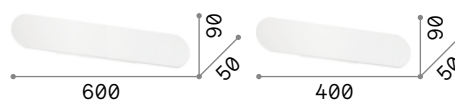

■ IP20

0,930 Kg / 0,0051 m³
LED 30W / 2850 lm

€ 154

273945 Bianco
285306 Nero
285313 Ottone Sat.

■ IP20

0,640 Kg / 0,0032 m³
LED 20W / 2000 lm

€ 132

^{new}273914 Bianco ^{new}
^{new}285283 Nero ^{new}
^{new}285290 Ottone Sat. ^{new}



Zig Zag ^{new}

Corpo luce dissipatore interamente in lastra d'alluminio da 6 mm di spessore. Rifinito con vernice a polveri di colore bianco o nero o placcato ottone. LED integrati.

LED

Sorgente luminosa LED 3000/4000 K, 15.000 h di durata.

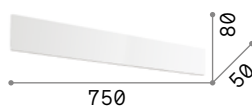

■ (⊕) IP20

1,040 Kg / 0,0053 m³
LED 30W / 2850/3000 lm

€ 132

277219 ■ Bianco 3000K^{new}
277257 ■ Bianco 4000K^{new}
277226 ■ Nero 3000K^{new}
287072 ■ Ottone 3000K^{new}

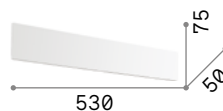

■ (⊕) IP20

0,590 Kg / 0,0029 m³
LED 22W / 2100/2200 lm

€ 99

179308 ■ Bianco 3000K
277240 ■ Bianco 4000K^{new}
179322 ■ Nero 3000K
282138 ■ Ottone 3000K^{new}

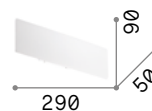

■ (⊕) IP20

0,450 Kg / 0,0020 m³
LED 12W / 1150/1200 lm

€ 85,80

179292 ■ Bianco 3000K
277233 ■ Bianco 4000K^{new}
179315 ■ Nero 3000K
282121 ■ Ottone 3000K^{new}



Kool

Corpo luce in vero cemento.
Supporto di fissaggio in metallo non visibile. Emette luce sopra e sotto.

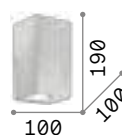

■ □ IP20

1,260 Kg / 0,0060 m³
GU10 max 2 x 15W

€ 94,60

141275 ■ Cemento

🔆 3000 K
480 lm

108292 € 4,95

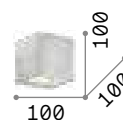

■ □ IP20

0,700 Kg / 0,0036 m³
G9 max 1 x 15W

€ 63,80

141268 ■ Cemento

🔆 3000 K
370 lm

209043 € 4,29

Flash

Montatura in metallo rifinito in effetto corten o vernice opaca di colore bianco. Emette luce sopra e sotto.

LED Lampadine LED G9 3W 3000 K incluse.
Cod. **209043**

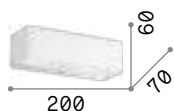

IP20

0,360 Kg / 0,0012 m³
G9 max 2 x 40W

€ 60,50

095288 Bianco

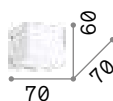

IP20

0,200 Kg / 0,0005 m³
G9 max 1 x 40W

€ 33

095264 Bianco
169118 Corten

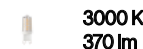

3000 K
370 lm

209043 € 4,29

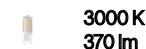

3000 K
370 lm

209043 € 4,29

Flash Gesso

Base in metallo smaltato. Corpo luce interamente in gesso. Doppia emissione luminosa: sopra e sotto.

Articolo adatto alla pittura e verniciatura.

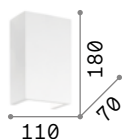

IP20

0,710 Kg / 0,0049 m³
G9 max 1 x 40W

€ 49,50

214689 Bianco

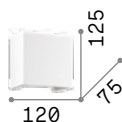

IP20

0,770 Kg / 0,0024 m³
G9 max 1 x 40W

€ 47,30

214672 Bianco

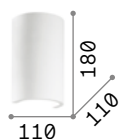

IP20

0,950 Kg / 0,0034 m³
G9 max 1 x 40W

€ 44

214696 Bianco

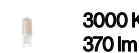

3000 K
370 lm

209043 € 4,29

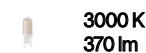

3000 K
370 lm

209043 € 4,29

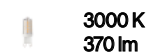

3000 K
370 lm

209043 € 4,29



095264

169118



214689, 214672 214696



Sky

Base e diffusore in metallo placcato o verniciato opaco o decorato in foglia d'oro o d'argento.

LED Lampadine LED GU10 5W 3000 K incluse. Cod. **108292**





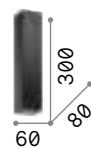

126883 **136905** **136882** **126890** **136899**



IP20 



0,940 Kg / 0,0049 m³
GU10 max 2x28W

€ 115,50

- 126883  Bianco
- 136905  Cromo
- 136882  Argento
- 126890  Nero
- 136899  Oro

 3000 K
480 lm

108292 € 4,95

 P. 073  P. 291



Look

Corpo luce in metallo con finitura rame, cromo, brunito o vernice opaca di colore bianco o nero.

LED Lampadine LED GU10 5W 3000 K
includ. Cod. **108292**



096018

094182

095998

164847

164823

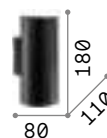

0,500 Kg / 0,0028 m³
GU10 max 2x 28W

€ 79,20

096018 Bianco
094182 Cromo
095998 Nero
164847 Rame
164823 Brunito

3000 K
480 lm

108292 € 4,95



P. 070

P. 290

P. 603

Paul

Base in metallo rifinito con vernice opaca. Diffusore in vetro soffiato, incamiciato e acidato. Disponibile con finitura bianca.

LED Lampadine LED G9 3W 3000 K incluse.
Cod. 209043



0,560 Kg / 0,0064 m³
G9 max 2 x 40W

€ 63,80

060620 Bianco



0,540 Kg / 0,0056 m³
G9 max 2 x 40W

€ 63,80

231129 Bianco

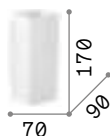

3000 K / 370 lm
209043 € 4,29

3000 K / 370 lm
209043 € 4,29

Elica

Montatura in metallo con finitura nickel satinato. Diffusore in vetro bianco soffiato e acidato.

LED Lampadine LED G9 3W 3000 K incluse.
Cod. 209043



0,980 Kg / 0,0217 m³
G9 max 2 x 40W

€ 82,50

017617 Bianco



3000 K / 370 lm
209043 € 4,29

Ovalino

Diffusore composto da elementi circolari in lastra di vetro curvata e acidata.



1,800 Kg / 0,0563 m³
E27 max 2 x 60W

€ 123,20

038025 Bianco

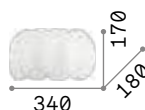

P. 166

P. 282

3000 K / 340 lm
101286 € 3,30

Soda

Corpo luce in gesso bianco. Base in metallo smaltato bianco. Diffusore inferiore in vetro trasparente satinato. Emissione luce sia sopra che sotto.



Articolo adatto alla pittura e verniciatura.



■ IP20

2,630 Kg / 0,0154 m³
E14 max 2x 40W

€ 99

105727 Bianco



3000 K
420 lm

101217 € 3,30

■ IP20

1,100 Kg / 0,0068 m³
E14 max 1x 40W

€ 62,70

105710 Bianco



3000 K
420 lm

101217 € 3,30

Tonic

Corpo luce in gesso bianco. Base in metallo smaltato bianco. Diffusore inferiore in vetro trasparente satinato. Emissione luce sia sopra che sotto.



Articolo adatto alla pittura e verniciatura.

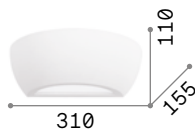

■ IP20

3,250 Kg / 0,0150 m³
E14 max 1x 40W

€ 72,60

105734 Bianco



3000 K
420 lm

101217 € 3,30



Smarties

Base in metallo. Diffusore in vetro soffiato bianco acidato con sistema di fissaggio senza viti.

LED Lampadine LED G9 3W 3000 K incluse.
Cod. **209043**

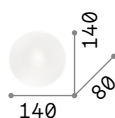

■ ■ □ IP20 

0,440 Kg / 0,0079 m³

G9 max 1x15W

€ 44

014814 ■ Bianco

 3000 K
370 lm

209043 € 4,29



P. 146



P. 279



P. 440

Mapa Bianco

Base e sistema di fissaggio in metallo bianco. Diffusore a sfera in vetro bianco soffiato e acidato.

LED Lampadine LED G9 3W 3000 K incluse
nel modello **059808**. Cod. **209043**

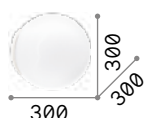

■ ■ □ IP20

1,660 Kg / 0,0647 m³
E27 max 1x 60W

€ 88

059822 ■ Bianco

 3000 K
430 lm

101279 € 3,30

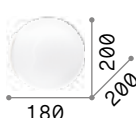

■ ■ □ IP20

0,900 Kg / 0,0259 m³
E27 max 1x 60W

€ 49,50

059815 ■ Bianco

 3000 K
430 lm

101279 € 3,30

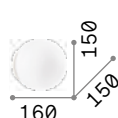

■ ■ □ IP20 

0,380 Kg / 0,0115 m³
G9 max 1x 15W

€ 44

059808 ■ Bianco

 3000 K
370 lm

209043 € 4,29



P. 156



P. 280



P. 441

Triplo

Diffusore con triplo vetro, uno trasparente e piano alla base e due smerigliati ad acido e ricurvi sulla parte superiore. Elementi ferma vetro in metallo cromato.

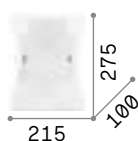
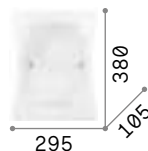

■ IP20

■ IP20

2,170 Kg / 0,0283 m³
E27 max 2x60W

1,260 Kg / 0,0141 m³
E27 max 1x60W

€ 70,40

€ 48,40

026480 Bianco

026473 Bianco

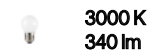

101286 € 3,30

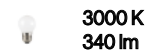

101286 € 3,30



Audi-B

Montatura in metallo cromato.
Diffusore in lastra di vetro trasparente con spessore di 10 mm.
Emette luce verso l'alto e verso il basso.

LED Lampadine LED R7s 6W 78 mm
3000 K incluse. Cod. **189109**



■ IP20

1,610 Kg / 0,0105 m³
R7s max 1x100W

€ 108,90

017082 Trasparen.

3000 K
380 lm

20, € 15,95



Ali

Diffusore in vetro bianco acidato composto da tre elementi: due laterali e uno frontale. Viti fermavetro cromate.

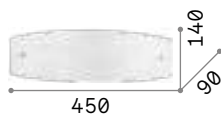

■ □ ⊕ IP20

1,410 Kg / 0,0204 m³

E27 max 2x 60W

€ 56,10

026558 ■ Bianco

💡 3000 K
340 lm

101286 € 3,30



Denis

Diffusore con triplo vetro. Due laterali in vetro trasparente acidato e uno frontale trasparente con decorazione bianca centrale serigrafata.

LED Lampadine LED R7s 7W 118 mm
3000 K include. Cod. **189093**

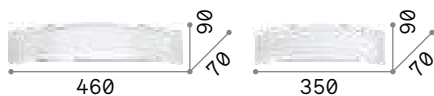

■ ⊕ IP20  ■ ⊕ IP20 

1,070 Kg / 0,0169 m³

R7s max 1x 100W

€ 71,50

005454 ■ Bianco

➡ 3000 K
560 lm

189093 € 20,35

0,820 Kg / 0,0132 m³

R7s max 1x 100W

€ 60,50

005294 ■ Bianco









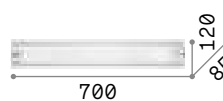
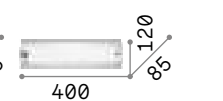
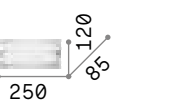

➡ 3000 K
560 lm

189093 € 20,35



Tudor









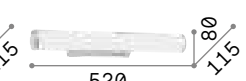

Base in metallo cromato. Diffusore composto da cornice in vetro trasparente molato e mezzo tubo in vetro pirex sabbato nella parte centrale.

		
700	400	250
■  IP20	■  IP20	■  IP20
1,900 Kg / 0,0214 m ³ E14 max 4 x 40W	1,130 Kg / 0,0117 m ³ E14 max 2 x 40W	0,700 Kg / 0,0077 m ³ E14 max 1 x 40W
€ 102,30	€ 68,20	€ 50,60
051864  Trasparen.	051857  Trasparen.	051840  Trasparen.
 3000 K 420 lm	 3000 K 420 lm	 3000 K 420 lm
101217 € 3,30	101217 € 3,30	101217 € 3,30



Camerino

Base in alluminio. Diffusore in vetro bianco soffiato e acidato, chiuso alle estremità da dischi in materiale acrilico trasparente.

		
650	520	370
■  IP20	■  IP20	■  IP20
1,170 Kg / 0,0157 m ³ E14 max 4 x 40W	0,960 Kg / 0,0123 m ³ E14 max 3 x 40W	0,780 Kg / 0,0097 m ³ E14 max 2 x 40W
€ 96,80	€ 85,80	€ 74,80
027104  Bianco	027098  Bianco	027081  Bianco
 3000 K 420 lm	 3000 K 420 lm	 3000 K 420 lm
101217 € 3,30	101217 € 3,30	101217 € 3,30





Essence ^{new}

Base e corpo luce in alluminio verniciato a polveri. Diffusore in materiale acrilico opale. Emissione luce indiretta. Colori: bianco o nero.

LED Sorgente luminosa LED 3000 K, 20.000 h di durata.



285115



285108

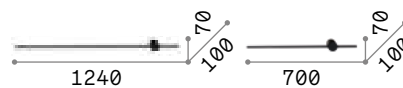

1,200 Kg / 0,0346 m³
LED 17W / 1850 lm

€ 236,50

265575 Bianco ^{new}
285108 Nero ^{new}



0,800 Kg / 0,0205 m³
LED 11W / 950 lm

€ 181,50

285115 Bianco ^{new}
265643 Nero ^{new}





Privè

Corpo luce interamente in metallo con varie finiture. L'assenza di diffusore consente di montare una vasta gamma di lampade con attacco E14.

159423



045627



159508



179681



■ IP20

1,420 Kg / 0,0143 m³
E14 max 8 x 40W

€ 119,90

159522 Bianco
045634 Cromo

3000 K
420 lm

101217 € 3,30

■ IP20

1,100 Kg / 0,0095 m³
E14 max 6 x 40W

€ 97,90

159423 Bianco
045627 Cromo
159508 Nero
179681 Ottone

3000 K
420 lm

101217 € 3,30

Line

Montatura in metallo con finitura in cromo. Diffusore a LED con barra a sezione quadrata in acrilico satinato.

LED Sorgente luminosa LED 3000 K, 20.000 h di durata.

ON/OFF Lampada con interruttore integrato.



IP20

0,790 Kg / 0,0046 m³
LED 8,4W / 740 lm

€ 192,50

031491 Cromo

IP20

0,540 Kg / 0,0028 m³
LED 4,8W / 420 lm

€ 137,50

031484 Cromo



Riflesso

Montatura in metallo rifinito in cromo o vernice bianca opaca. Diffusore in materiale acrilico trasparente e satinato.

LED Sorgente luminosa LED 3000 K, 30.000 h di durata.

IP44 Grado di protezione IP44.

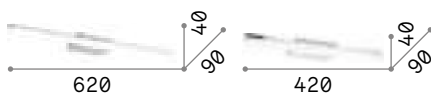

IP44

0,750 Kg / 0,0192 m³
LED 14W / 1350 lm

€ 193,60

142289 Bianco
142265 Cromo

IP44

0,600 Kg / 0,0143 m³
LED 11W / 900 lm

€ 151,80

142296 Bianco
142272 Cromo



142296

142272



Alma

Corpo luce in metallo rifinito ottone satinato, cromo o con vernice a polveri bianco. Diffusore fisso in materiale plastico colore opale.

LED Sorgente luminosa LED 3000 K, 20.000 h di durata.

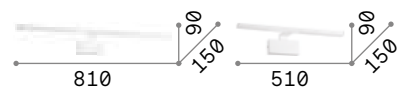

■ □ IP20

0,660 Kg / 0,0264 m³
LED 20W / 1620 lm

€ 159,50

225029 □ Bianco
224992 ▨ Cromo
225005 ■ Ottone Sat.

■ □ IP20

0,650 Kg / 0,0162 m³
LED 12W / 1020 lm

€ 121

224985 □ Bianco
224930 ▨ Cromo
224954 ■ Ottone Sat.



Bonjour

Montatura in metallo o bianco.
Diffusore inclinabile con schermo in
materiale plastico. Led integrato.

LED Sorgente luminosa LED 3000 K,
20.000 h di durata.



199870



199894

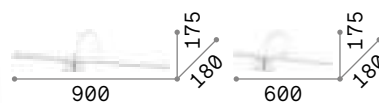

■ □ IP20

0,530 Kg / 0,0407 m³
LED 12W / 900 lm

€ 205,70

199931 ■ Bianco
199917 ■ Cromo

■ □ IP20

0,480 Kg / 0,0265 m³
LED 8W / 650 lm

€ 167,20

199894 ■ Bianco
199870 ■ Cromo



Bow

Montatura in metallo con finitura disponibile in brunito, cromo, nickel o ottone satinato. Diffusore a LED inclinabile. Interruttore sulla base.

LED Sorgente luminosa LED 3000 K, 20.000 h di durata.

ON OFF Lampada con interruttore integrato.

■ IP20	■ IP20	■ IP20
0,860 Kg / 0,0328 m³ LED 7,98W / 600 lm	0,790 Kg / 0,0207 m³ LED 4,62W / 350 lm	0,640 Kg / 0,0117 m³ LED 2,52W / 200 lm
€ 187	€ 137,50	€ 117,70
007021 Cromo 007069 Nickel 121130 Ottone Sat. 121147 Brunito	007045 Cromo 007038 Nickel 121178 Ottone Sat. 121161 Brunito	005386 Cromo 005379 Nickel 121154 Ottone Sat. 121338 Brunito



Mirror-10

Montatura in metallo con finitura
in brunito, cromo o nickel satinato.
Diffusore posizionabile.

LED Lampadine LED G9 3W 3000 K incluse.
Cod. **209043**

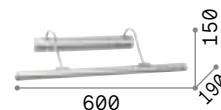

IP20

1,090 Kg / 0,0181 m³
G9 max 4 x 40W

€ 137,50

017303 Cromo
017297 Nickel
017310 Brunito

3000 K
370 lm
209043 € 4,29



Retrò

Base braccio e diffusore
interamente in metallo con finitura
brunito. Diffusore orientabile.



■  IP20

0,790 Kg / 0,0152 m³
E14 max 2x28W

€ 115,50

144917 ■ Brunito

 3000 K
470 lm
101224 € 3,30

Mirror-20

Montatura in metallo con finitura disponibile in brunito, in cromo o in ottone. Diffusore regolabile.

LED Lampadine LED G9 3W 3000 K incluse.
Cod. 209043

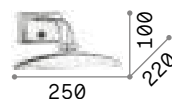

IP20 INCLUSA

0,550 Kg / 0,0077 m³
G9 max 2 x 40W

€ 93,50

017334 **Cromo**
031507 **Ottone**
017327 **Brunito**

3000 K / 370 lm
209043 € 4,29



017334



031507



017327

Cico

Montatura in metallo con finitura cromo. Diffusori indipendenti tra loro e posizionabili.

LED Lampadine LED G9 3W 3000 K incluse.
Cod. 209043

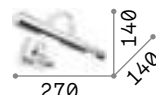

IP20 INCLUSA

0,530 Kg / 0,0036 m³
G9 max 2 x 40W

€ 88

014432 **Cromo**

3000 K / 370 lm
209043 € 4,29



Double

Montatura in metallo cromato. Diffusori in vetro pirex trasparente chiuso alle estremità e smerigliato a sabbia nelle parti centrali.

LED Lampadine LED G9 3W 3000 K incluse.
Cod. 209043

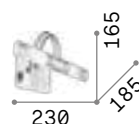

IP20 INCLUSA

0,530 Kg / 0,0042 m³
G9 max 2 x 40W

€ 66

008851 **Cromo**

3000 K / 370 lm
209043 € 4,29





Focus

Corpo luce in metallo con braccio flessibile orientabile rivestito in gomma. Rifinito in bianco o in nero opaco oppure in grigio con dettagli in cromo.

LED Sorgente luminosa LED 3000 K, 30.000 h di durata.

ON OFF Lampada con interruttore integrato.



097183



097206



097190



203171



203188



203195

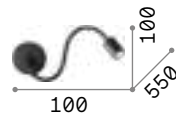

IP20

0,400 Kg / 0,0025 m³
LED 3W / 210 lm

€ 68,20

097183 ■ Bianco
097206 ■ Cromo
097190 ■ Nero

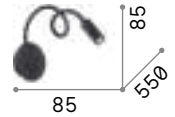

IP20

0,410 Kg / 0,0020 m³
LED 3W / 210 lm

€ 72,60

203171 ■ Bianco
203188 ■ Cromo
203195 ■ Nero



IO new

Corpo luce da incasso con montatura in metallo verniciato a polveri. Braccio flessibile rivestito in gomma. Diffusore con schermo acrilico trasparente zigrinato. Interruttore incorporato. Colori: bianco o nero.

LED Sorgente luminosa LED 3000 K, 50.000 h di durata.

ON OFF Lampada con interruttore integrato.



285320



272030

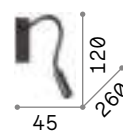

IP20

0,240 Kg / 0,0027 m³
LED 3W / 300 lm

€ 126,50

285320 **Bianco** new
272030 **Nero** new



Goose

Montatura e diffusore in fusione d'alluminio verniciato a polveri con colori opachi. Braccio flessibile rivestito in gomma siliconica.



Sorgente luminosa LED 3000 K, 30.000 h di durata.



Lampada con interruttore integrato.



142708

142692

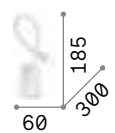

IP20

0,430 Kg / 0,0040 m³
LED 3W / 200 lm

€ 143

142708 ■ Bianco
142692 ■ Nero

Flex

Montatura e braccio flessibile in metallo con finitura disponibile in cromo e nickel. Diffusore orientabile a piacere. Dotato di interruttore sulla base.

LED Lampadine LED GU10 5W 3000 K incluse. Cod. **108292**

ON/OFF Lampada con interruttore integrato.



0,270 Kg / 0,0014 m³
GU10 max 1x50W

€ 36,30

000305 Cromo
006161 Nickel

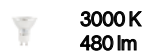

108292 € 4,95



000305



006161

Dynamo

Montatura e braccio flessibile in metallo con finitura disponibile in cromo, nickel e brunito. Diffusore orientabile a piacere. Dotato di interruttore sulla base.

LED Sorgente luminosa LED 4000 K, 20.000 h di durata.

ON/OFF Lampada con interruttore integrato.

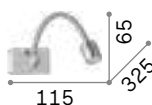

0,500 Kg / 0,0031 m³
LED 3W / 200 lm

€ 85,80

031460 Cromo
031477 Nickel
121352 Brunito



031460



031477



121352



Bean

Base e diffusore orientabile in metallo placcato o verniciato a polveri. Colori bianco, nero oppure ottone o nickel con interruttore e snodo neri.

LED Sorgente luminosa LED 3000 K, 20.000 h di durata.

ON OFF Lampada con interruttore integrato.

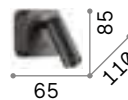

IP20

0,180 Kg / 0,0008 m³
LED 3,5W / 220 lm

€ 47,30

260648 Bianco
260679 Nickel
260655 Nero
260662 Ottone

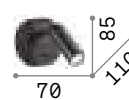

IP20

0,180 Kg / 0,0005 m³
LED 3,5W / 220 lm

€ 47,30

260600 Bianco
260631 Nickel
260617 Nero
260624 Ottone



Page

Corpo luce in alluminio verniciato a polveri bianco o nero. Diffusore orientabile con lente e elemento snodato in metallo cromato.

LED Sorgente luminosa LED 3000 K, 30.000 h di durata.

ON OFF Lampada con interruttore integrato.

142586



142579

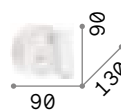

IP20

0,280 Kg / 0,0030 m³
LED 3W / 210 lm

€ 99

142586 ■ Bianco
142579 ■ Nero

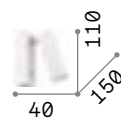

IP20

0,420 Kg / 0,0023 m³
LED 3W / 210 lm

€ 103,40

142258 ■ Bianco
142241 ■ Nero



Pipe **new**

Corpo luce in alluminio verniciato a polveri. Diffusore orientabile con schermo acrilico zigrinato, fissato con ghiera. Interruttore incorporato. Colori: bianco o nero.

LED Sorgente luminosa LED 3000 K, 20.000 h di durata.

ON OFF Lampada con interruttore integrato.



280998



281001

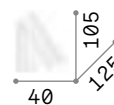

■ □ IP20

0,400 Kg / 0,0009 m³
LED 7W / 660 lm

€ 99

280998 ■ Bianco **new**
281001 ■ Nero **new**



Lite

Base e corpo luce in alluminio con finitura bianco, nero, nickel o ottone. Diffusore orientabile. Interruttore incorporato. Installazione ad incasso su scatola di derivazione tipo 502, non inclusa.

LED Sorgente luminosa LED 3000 K, 20.000 h di durata.

ON OFF Lampada con interruttore integrato.

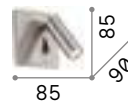

IP20

0,340 Kg / 0,0008 m³
LED 3W / 200 lm

€ 60,50

250106 Bianco
250137 Nickel
250113 Nero
250120 Ottone

Probe

Corpo luce in alluminio verniciato a polveri bianco o nero. Doppio diffusore: superiore in acrilico e inferiore con braccetto flessibile.

LED Sorgente luminosa LED 3000 K, 20.000 h di durata.

ON OFF Lampada con interruttore integrato.

USB Lampada con presa USB integrata.

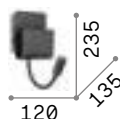

■ IP20

0,870 Kg / 0,0020 m³

LED 9W / 700 lm

€ 146,30

243160 ■ Bianco

237930 ■ Nero



Read

Montatura metallica verniciata a polveri con finitura bianca o nera. Diffusore orientabile con LED integrato. Presa USB.

LED Sorgente luminosa LED 3000 K, 15.000 h di durata.

ON OFF Lampada con interruttore integrato.

USB Lampada con presa USB integrata.

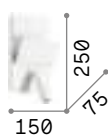

■ IP20

1,060 Kg / 0,0049 m³

LED 3W / 200 lm

€ 148,50

176536 ■ Bianco

176550 ■ Nero





Book

Montatura metallica verniciata a polveri. Diffusore in vetro satinato. Braccio flessibile gommato con LED. Doppio interruttore. Presa USB.

LED Sorgente luminosa LED 3000 K, 15.000 h di durata.

ON/OFF Lampada con interruttore integrato.

USB Lampada con presa USB integrata.



IP20

IP20

1,570 Kg / 0,0125 m³
G9 max 1x 28W +
LED 3W / 200 lm

1,570 Kg / 0,0125 m³
G9 max 1x 28W +
LED 3W / 200 lm

€ 176

€ 176

174792 ■ Bianco
174808 ■ Nero

174822 ■ Bianco
174846 ■ Nero

3000 K
370 lm
209043 € 4,29

3000 K
370 lm
209043 € 4,29

Mouse

Base, montatura e diffusori in metallo rifinito con vernice opaca e dettagli in cromo. Diffusori orientabili. Disponibile nelle finiture bianco o nero.

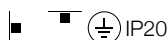
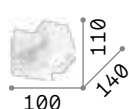

0,910 Kg / 0,0067 m³
GU10 max 2x 50W

0,450 Kg / 0,0034 m³
GU10 max 1x 50W

€ 126,50

€ 71,50

073545 ■ Bianco
156705 ■ Nero

073521 ■ Bianco
073569 ■ Nero

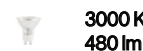

108292 € 4,95

108292 € 4,95



P. 300

P. 602

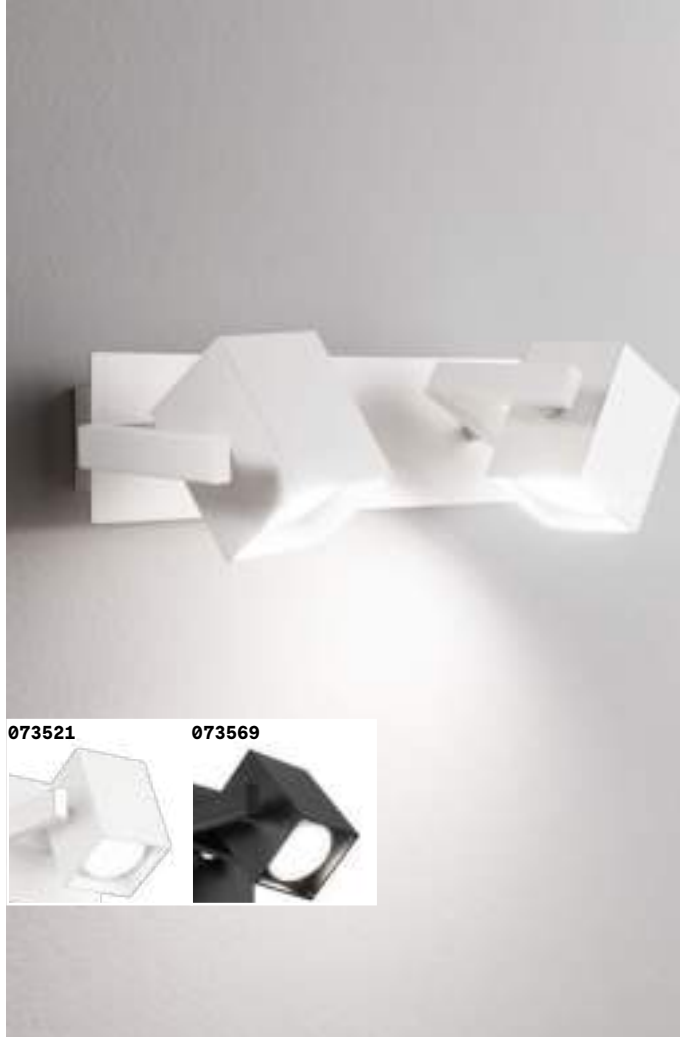

073521

073569



Spot

Base, montatura e diffusori in metallo rifinito con vernice opaca e dettagli in cromo. Diffusori orientabili. Disponibile nelle finiture bianco o nero.

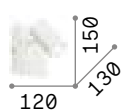
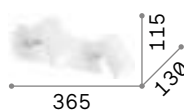

0,610 Kg / 0,0060 m³
GU10 max 2x 50W

0,410 Kg / 0,0037 m³
GU10 max 1x 50W

€ 51,70

€ 31,90

156736 ■ Bianco
156743 ■ Nero

156729 ■ Bianco
115481 ■ Nero

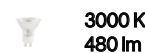
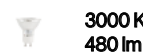

108292 € 4,95

108292 € 4,95



P. 300

P. 602



156729

115481



Gim

Montatura in alluminio verniciato a polveri. Diffusore ruotabile a polveri. Diffusore ruotabile con schermo acrilico satinato. Interruttore incorporato. LED integrati.

LED Sorgente luminosa LED 3000 K, 15.000 h di durata.

ON OFF Lampada con interruttore integrato.

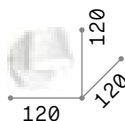

IP20

0,450 Kg / 0,0034 m³

LED 6W / 530 lm

€ 77

167152 ■ Bianco

167121 ■ Nero



167152



167121



Rudy

Montatura in alluminio pressofuso verniciato a polveri bianco o nero. Diffusori orientabili in rotazione e inclinazione.

LED Lampadine LED GU10 5W 3000 K incluse. Cod. **108292**

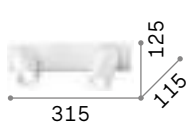

IP20

0,570 Kg / 0,0046 m³
GU10 max 2 x 35W

€ 99

229041 ■ Bianco

229034 ■ Nero

3000 K
480 lm

108292 € 4,95

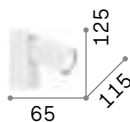

IP20

0,270 Kg / 0,0017 m³
GU10 max 1 x 35W

€ 49,50

229027 ■ Bianco

229010 ■ Nero

3000 K
480 lm

108292 € 4,95

P. 301



229041



229034



Oby

Montatura in metallo verniciato bianco opaco, con snodi cromati.
Corpo luce orientabile con diffusore in materiale plastico bianco.

LED Sorgente luminosa LED 3000 K, 20.000 h di durata.



IP20

0,620 Kg / 0,0030 m³
LED 12W / 1100 lm

€ 121

196695 Bianco

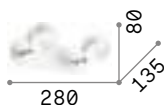

IP20

0,310 Kg / 0,0020 m³
LED 6W / 550 lm

€ 60,50

196688 Bianco



3000 K

P. 301

Snake

Montatura in metallo cromato.
Corpo luce posizionabile. Diffusore in vetro bianco soffiato e acidato.

IP20

0,980 Kg / 0,0096 m³
E14 max 3x40W

€ 71,50

002774 Cromo

3000 K / 420 lm
101217 € 3,30

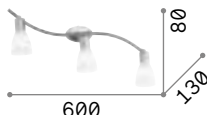

IP20

0,380 Kg / 0,0029 m³
E14 max 1x40W

€ 27,50

002705 Cromo

3000 K / 420 lm
101217 € 3,30



Elis

Montatura in metallo cromato.
Corpo luce orientabile. Diffusore in vetro pirex trasparente e smerigliato a sabbia nella parte centrale.

IP20

0,920 Kg / 0,0064 m³
E14 max 3x40W

€ 93,50

031095 Cromo

3000 K / 420 lm
101217 € 3,30

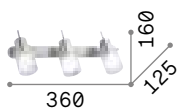

IP20

0,350 Kg / 0,0024 m³
E14 max 1x40W

€ 33

031071 Cromo

3000 K / 420 lm
101217 € 3,30



Alfa ^{new}

Montatura in metallo con finitura in cromo, brunito, bianco satinato, nickel satinato od ottone satinato. Corpo luce posizionabile con rotazione dello stelo e snodo per l'inclinazione.

LED Lampadine LED GU10 5W 3000 K incluse. Cod. **108292**

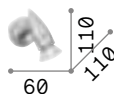
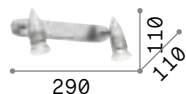

0,390 Kg / 0,0031 m³
GU10 max 2 x 50W

0,170 Kg / 0,0010 m³
GU10 max 1 x 50W

€ 44

€ 22

122717 Bianco
089577 Cromo
009483 Nickel
287829 Ottone Sat. ^{new}

099057 Bianco
089560 Cromo
009377 Nickel
285009 Ottone Sat. ^{new}
119786 Brunito

3000 K
480 lm
108292 € 4,95

3000 K
480 lm
108292 € 4,95



P. 304



099057

089560

009377

285009

119786

Slem ^{new}

Montatura in metallo con finitura in bianco, cromo, nickel satinato od ottone satinato. Corpo luce posizionabile con rotazione dello stelo e snodo per l'inclinazione.

LED Lampadine LED GU10 5W 3000 K incluse. Cod. **108292**

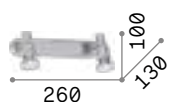

0,400 Kg / 0,0025 m³
GU10 max 2 x 50W

0,200 Kg / 0,0010 m³
GU10 max 1 x 50W

€ 44

€ 22

142081 Bianco
142050 Cromo
018836 Nickel
287836 Ottone Sat. ^{new}

099064 Bianco
122984 Cromo
018829 Nickel
285016 Ottone Sat. ^{new}

3000 K
480 lm
108292 € 4,95

3000 K
480 lm
108292 € 4,95



P. 304



099064

122984

018829

285016

Barber

Base, snodo e copri portalampane interamente in metallo. Corpo luce inclinabile. Disponibile nella versione brunito o nickel.

LED Lampadine LED GU10 7W 3000 K incluse. Cod. **123943**

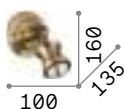

0,230 Kg / 0,0025 m³
GU10 max 1x28W

€ 71,50

160016 ■ Nickel
159997 ■ Brunito

3000 K
630 lm

123943 € 4,95

160016



159997



Bob Mini

Montatura in metallo decorato effetto ruggine. Diffusori orientabili con raccordo di cavo in tessuto e gabbietta metallica nera.

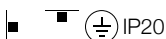
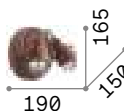

0,630 Kg / 0,0060 m³
GU10 max 2x25W

€ 99

156408 ■ Corten

3000 K
480 lm

108292 € 4,95

0,290 Kg / 0,0025 m³
GU10 max 1x25W

€ 55

156392 ■ Corten

3000 K
480 lm

108292 € 4,95





Winery

Corpo luce con portalampane incorporato interamente in ceramica smaltata bianca o nera. Modello AP con assetto inclinato verso il basso.



180298



180304

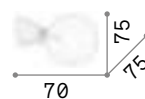

IP20

0,250 Kg / 0,0004 m³
E27 max 1x 60W

€ 25,30

180298 ■ Bianco
180304 ■ Nero

3000 K
1120 lm

101323 € 8,25



P. 299



Radio

Rosone e montatura in metallo.
Diffusore posizionabile. Cavo elettrico in tessuto. Disponibile con finitura in cromo o con vernice opaca bianca o nera.

LED Lampadine LED E27 8W Globo D125 trasparente 3000 K incluse.
Cod. **101347**

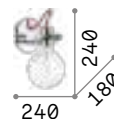

IP20 

0,450 Kg / 0,0119 m³
E27 max 1x 60W

€ 69,30

119465  Bianco
119427  Cromo
119502  Nero

 3000 K
1020 lm

101347 € 9,35



Edison

Montatura in metallo rifinito con vernice opaca bianca o nera. Cavo elettrico in tessuto. Diffusore orientabile.



138374



148908

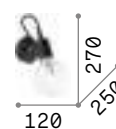

IP20

0,410 Kg / 0,0134 m³
E27 max 1x60W

€ 60,50

138374 ■ Bianco
148908 ■ Nero

3000 K
1020 lm

101347 € 9,35



P. 107



Minimal

Montatura in metallo rifinito in cromo o in smalto colorato. Cavo elettrico con rivestimento in tessuto.

LED

Lampadine LED E27 8W Globo D125 trasparente 3000 K incluse.
Cod. **101347**

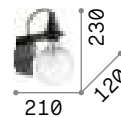

IP20

0,720 Kg / 0,0164 m³
E27 max 1x60W

€ 77

045191 ■ Bianco
045207 ■ Cromo
045214 ■ Nero

3000 K
1020 lm

101347 € 9,35



P. 108

P. 476



Frida

Montatura e copri porta lampade in metallo con finiture brunito e rame. Cavo in tessuto nero.

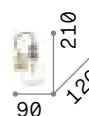

IP20

0,430 Kg / 0,0092 m³
E27 max 1x60W

€ 46,20

163338 ■ Rame
163321 ■ Brunito

2200 K
500 lm

151717 € 9,79





Igor

Montatura in metallo rifinito con vernice opaca nera. Diffusore con lastre di vetro trasparente.

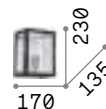

■  IP20

1,590 Kg / 0,0136 m³
E27 max 1x60W

€ 92,40

092836 ■ Nero

 2200 K
440 lm

151694 € 7,70



P. 089



Birds ^{new}

Montatura in metallo verniciato con disco decorativo in ottone satinato. Diffusori in vetro soffiato bianco acidato. Colore: nero opaco con dettaglio ottone satinato.

LED Lampadine LED G9 3W 3000 K incluse.
Cod. **209043**

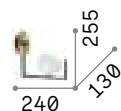

IP20 INCLUSA

0,670 Kg / 0,0192 m³
G9 max 1x 15W

€ 71,50

273655 ■ Nero ^{new}

3000 K
370 lm

209043 € 4,29

Nodi

Montatura in metallo cromato.
Elementi di giunzione ruotabili per
una disposizione personalizzata.
Diffusori in vetro bianco soffiato,
acidato.

LED Lampadine LED G4 2W 3000 K incluse.
Cod. **222257**

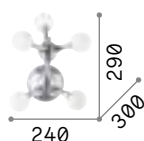

■ ■ ■ IP20

1,400 Kg / 0,0245 m³

G4 max 5 x 2W

€ 203,50

022277 ■ Bianco

3000 K
170 lm

222257

€ 4,95



P. 165



P. 306



Kepler

Montatura in metallo verniciato
nero opaco. Diffusori in vetro
soffiato trasparente ambrato.

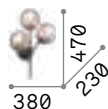

■ □ IP20

0,900 Kg / 0,0428 m³

E27 max 3 x 60W

€ 242

187006 ■ Nero

3000 K
430 lm

101279

€ 3,30



P. 094





Perlage ^{new}

Montatura in metallo con struttura lineare a sezione tonda. Diffusori in vetro soffiato trasparente. Colori: nero opaco oppure ottone satinato.

LED

Lampadine LED G9 3W 3000 K incluse.
Cod. 209043

**ON
OFF**

Lampada con interruttore integrato.



283784



271439

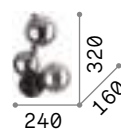

IP20

0,800 Kg / 0,0219 m³
G9 max 3 x 15W

€ 143

271439 ■ Nero ^{new}
283784 ■ Ottone Sat. ^{new}

3000 K
370 lm

209043

€ 4,29



P. 091

Triumph

Montatura interamente in metallo con finitura nero o ottone invecchiato. Modelli AP con cavo in tessuto con interruttore e spina.



Lampada con interruttore integrato.

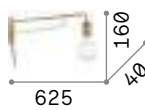

0,710 Kg / 0,0067 m³
E27 max 2 x 60W

0,490 Kg / 0,0083 m³
E27 max 1 x 60W

€ 159,50

€ 104,50

242385 ■ Nero
160245 ■ Ottone

242392 ■ Nero
160214 ■ Ottone



2200 K
370 lm

151687

€ 6,05



2200 K
370 lm

151687

€ 6,05



P. 086

P. 308



242392

160214

Maracas ^{new}

Montatura interamente in metallo rifinito in bianco od ottone satinato. Diffusori orientabili in vetro soffiato trasparente.



Lampadine LED G4 2W 3000 K incluse.
Cod. 222257

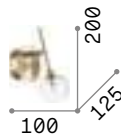
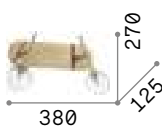

0,550 Kg / 0,0049 m³
G4 max 2 x 2W

0,280 Kg / 0,0034 m³
G4 max 1 x 2W

€ 137,50

€ 71,50

200385 ■ Bianco ^{new}
200347 ■ Ottone

200378 ■ Bianco ^{new}
200330 ■ Ottone



3000 K
170 lm

222257

€ 4,95



3000 K
170 lm

222257

€ 4,95



P. 305



200378

200330



Equinoxe

Montatura a bracci in metallo con finitura cromo o ottone antico. Diffusori in vetro soffiato trasparente.

LED Lampadine LED G4 2W 3000 K incluse.
Cod. 222257



200149



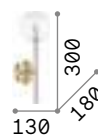

200132



IP20

0,990 Kg / 0,0243 m³
G4 max 1x2W

€ 126,50

200132  Cromo
200149  Ottone

 3000 K
170 lm

222257 € 4,95



P. 093

Cantina

Montatura, diffusore e copriportalampada in metallo disponibile con finitura brunito o rame. Cavo in tessuto.

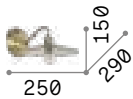

■  IP20

0,520 Kg / 0,0184 m³
E14 max 1x40W

€ 77

112695 ■ Rame
112626 ■ Brunito



3000 K
480 lm



101200 € 3,30 [P. 124](#)



112695

112626

Newton

Montatura e diffusore in metallo. Disponibile con finitura in nickel satinato, brunito o con vernice nera opaca. Braccio regolabile. Diffusore orientabile smaltato bianco all'interno.

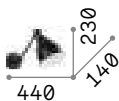

■  IP20

0,600 Kg / 0,0093 m³
E27 max 1x60W

€ 60,50

016399 ■ Nickel
027852 ■ Nero
027876 ■ Brunito



3000 K
900 lm



123899 € 7,70 [P. 478](#)



016399



027852



027876



Shower

Montatura in metallo verniciato opaco nero. Elemento snodato in cromo. Diffusore orientabile. Cavo in tessuto con interruttore e spina.



Lampada con interruttore integrato.

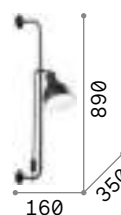

IP20

0,760 Kg / 0,0391 m³
E27 max 1x60W

€ 126,50

179643 ■ Nero

3000 K
900 lm

123899 € 7,70



Pan

Diffusore con tubi decorativi di diverse misure in metallo placcato. Emissione luce sopra e sotto.

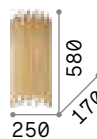

■  IP20

6,340 Kg / 0,0461 m³
E14 max 2x 40W

€ 396

208794  Oro

 3000 K
470 lm

101224 € 3,30



P. 085



Sunrise

Corpo luce interamente in metallo
rifinito con vernice opaca nera,
interno in foglia oro.

LED Lampadine LED G9 3W 3000 K incluse.
Cod. **209043**

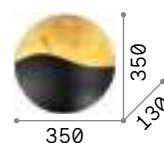

1,290 Kg / 0,0362 m³
G9 max 4 x 40W

€ 225,50

133300 Nero Oro

3000 K
370 lm

209043 € 4,29



0,850 Kg / 0,0224 m³
G9 max 3 x 40W

€ 192,50

133270 Nero Oro

3000 K
370 lm

209043 € 4,29



Tick

Corpo luce in metallo verniciato a polveri bianco o rifinito in foglia oro o argento. Diffusore inclinabile di 90°.

LED Sorgente luminosa LED 3000 K, 30.000 h di durata.



238951



238975



238944

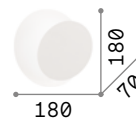

■ □ IP20

0,440 Kg / 0,0029 m³
LED 6W / 600 lm

€ 62,70

238975 ■ Bianco
238951 ■ Argento
238944 ■ Oro



Eclissi

Montatura in metallo rifinito con vernice a polveri e foglia oro. Il posizionamento variabile del diffusore superiore, consente una rifrazione luminosa più bianca o più dorata.

LED Sorgente luminosa LED 3000 K, 17.500 h di durata.



259062



259048

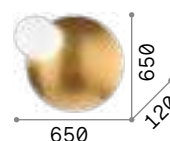

■ □ IP20

5,600 Kg / 0,0615 m³
LED 28W / 2630 lm

€ 363

259062 ■ Oro

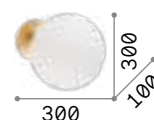

■ □ IP20

1,400 Kg / 0,0131 m³
LED 11W / 940 lm

€ 110

259048 ■ Bianco



P. 188 P. 456 P. 496

Set up

Montature in metallo verniciato a polveri o placcato. Applique a due luci con braccio flessibile rivestito in gomma, interruttori indipendenti e presa USB. Paralumi in pvc ignifugo rivestito di tessuto. Colori montature: bianco, nero oppure nichel satinato o ottone spazzolato con dettagli neri. Colori paralumi: beige, bianco o nero.



LED Sorgente luminosa LED 3000 K nel modello **259819, 259826, 259833** e **259857**, 20.000 h di durata.

ON/OFF Lampada con interruttore integrato nei modelli: **259819, 259826, 259833** e **259857**.

USB Lampada con presa USB integrata nei modelli: **259819, 259826, 259833** e **259857**.



259765

259796

259772

259802

260068

260075

260082

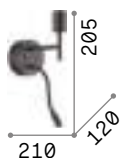

IP20

0,900 Kg / 0,0063 m³
E27 max 1x60W + LED 3W / 220 lm

€ 115,50

- 259819 ■ Bianco
- 259833 ■ Nickel
- 259826 ■ Nero
- 259857 ■ Ottone

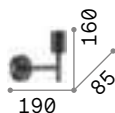

IP20

0,370 Kg / 0,0032 m³
E27 max 1x60W

€ 55

- 259765 ■ Bianco
- 259796 ■ Nickel
- 259772 ■ Nero
- 259802 ■ Ottone

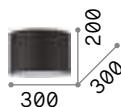

0,023 Kg / 0,0238 m³

€ 55

- 260433 ■ Bianco
- 270005 ■ Nero
- 260440 ■ Beige

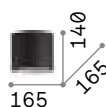

0,012 Kg / 0,0180 m³

€ 27,50

- 260327 ■ Bianco
- 269986 ■ Nero
- 260334 ■ Beige

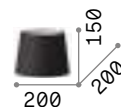

0,013 Kg / 0,0180 m³

€ 27,50

- 260068 ■ Bianco
- 260075 ■ Nero
- 260082 ■ Beige

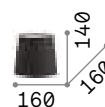

0,011 Kg / 0,0180 m³

€ 24,20

- 260341 ■ Bianco
- 270036 ■ Nero
- 260358 ■ Beige

123899 € 7,70

123899 € 7,70



Hilton

Montatura in cromo. Paralume in lamina di PVC rivestita in tessuto bianco, chiuso da vetro trasparente acidato.



Lampadine LED G9 3W 3000 K incluse.
Cod. **209043**

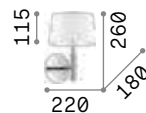

IP20 TRUSSARDI

0,700 Kg / 0,0105 m³
G9 max 1x40W

€ 77

075471 Bianco

3000 K
370 lm

209043 € 4,29



P. 185



P. 451



P. 501



Woody

Montatura in metallo cromato.
Diffusore in PVC o in tessuto,
chiuso sul fondo da vetro
trasparente acidato.

LED Lampadine LED G9 3W 3000 K incluse.
Cod. **209043**



143156



087665

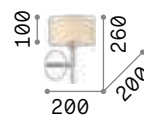

IP20 G9 LED

0,460 Kg / 0,0100 m³
G9 max 1x 40W

€ 74,80

143156 **Bianco**
087665 **Legno**



P. 184

P. 284

3000 K
370 lm

209043

€ 4,29

Luxury

Montatura in metallo rifinita in ottone o cromo. Base nera opaca. Paralume in pvc con bordi in tessuto.

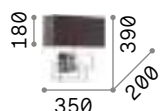

■ IP20

1,220 Kg / 0,0371 m³
E27 max 1x 60W

€ 247,50

201054 Cromo
201092 Ottone

3000 K
910 lm

119571 € 7,70



P. 450

P. 499

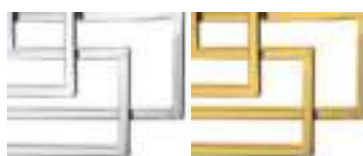

201054

201092

Nordik

Montatura in metallo verniciato nero opaco. Paralume in lamina di PVC dorato rivestito in tessuto nero.

LED Sorgente luminosa LED 3000 K,
15.000 h di durata.

ON OFF Lampada con interruttore integrato.

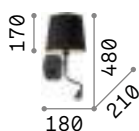

■ IP20

0,630 Kg / 0,0156 m³
E14 max 1x 40W +
LED 1W / 55 lm

€ 110

158242 Nero

3000 K
480 lm

101200 € 3,30



P. 182

P. 450

P. 498





Hotel

Paralume rivestito in tessuto.
Diffusori in vetro satinato. Modello
AP2 con LED esterno orientabile e
interruttore indipendente.

LED

Sorgente luminosa LED 3000 K nel
modello **215693**, **035949**, **103204**,
215709 e **035956**, 15.000 h di durata.

**ON
OFF**

Lampada con interruttore integrato nei
modelli: **215693**, **035949**, **103204**,
215709 e **035956**.

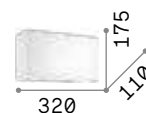
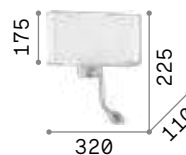

IP20

IP20

1,410 Kg / 0,0166 m³
E27 max 1x60W +
LED 1W / 55 lm

1,230 Kg / 0,0166 m³
E27 max 1x60W

€ 110

€ 82,50

215693 Total White
035949 Bianco
215709 Total Black
035956 Nero
103204 Canvas

152851 Bianco

3000 K
900 lm

123899 € 7,70

3000 K
900 lm

123899 € 7,70

Holiday

Montatura in metallo verniciato opaco. Paralume con lamina di pvc rivestita in tessuto. Interruttore unico con controllo indipendente delle due sorgenti luminose.

LED Sorgente luminosa LED 3000 K, 15.000 h di durata.

ON OFF Lampada con interruttore integrato.

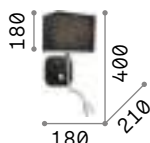

■ IP20

0,640 Kg / 0,0111 m³

E14 max 1x40W +
LED 1W / 55 lm

€ 110

124162 Bianco

124179 Nero

3000 K
420 lm

101217 € 3,30



124162



124179



Sheraton

Montatura in metallo cromato. Paralumi in lamina di PVC rivestita di tessuto. Applique con luci a controllo indipendente da interruttore unico.

LED Sorgente luminosa LED 3000 K, 15.000 h di durata.

ON OFF Lampada con interruttore integrato.

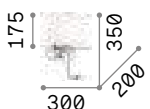

■ IP20

0,770 Kg / 0,0145 m³

E14 max 1x40W +
LED 1W / 45 lm

€ 121

074900 Bianco

074917 Marrone

3000 K
420 lm

101217 € 3,30



074900



074917





Gea

Corpo luce in alluminio verniciato a polveri bianco o nero. Diffusore con led integrato orientabile. Paralume in pvc rivestito di tessuto. Presa USB. Interruttori indipendenti.

LED Sorgente luminosa LED 3000 K, 20.000 h di durata.

ON OFF Lampada con interruttore integrato.

USB Lampada con presa USB integrata.



239576



239613



239590



239606

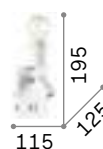

IP20

0,50 Kg / 0,0022 m³
E27 max 1x60W +
LED 3W / 200 lm

€ 121

239521 ■ Bianco
239545 ■ Nero

3000 K
900 lm

123899 € 7,70

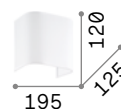

0,140 Kg / 0,0180 m³

€ 16,50

239576 ■ Bianco
239613 ■ Grigio
239590 ■ Nero
239606 ■ Canvas

Calypso

Montatura in metallo con finitura cromo. Elementi decorativi quadrati in cristallo molato.

LED Lampadine LED G9 3W 3000 K incluse.
Cod. **209043**

IP20

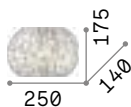

1,420 Kg / 0,0125 m³
G9 max 2x40W

€ 154

044163 Cromo

3000 K / 370 Lm
209043 € 4,29



P. 192



Roma

Montatura e dettagli in metallo cromato. Diffusore con elementi quadrati in cristallo molato sulla fascia laterale e vetro sabbato sul fondo.

LED Lampadine LED G9 3W 3000 K incluse.
Cod. **209043**

IP20

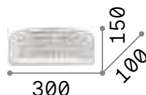

1,200 Kg / 0,0147 m³
G9 max 2x40W

€ 165

093086 Cromo

3000 K / 370 Lm
209043 € 4,29



P. 199



P. 318



P. 462



Pashà

Montatura in metallo. Diffusore composto da filari di perle in cristallo molato e fondo chiuso da vetro circolare sabbato.

LED Lampadine LED G9 3W 3000 K incluse.
Cod. **209043**

IP20



1,110 Kg / 0,0076 m³
G9 max 3x40W

€ 209

082264 Cromo

082288 Oro

3000 K / 370 Lm
209043 € 4,29



P. 201



P. 319



082264



082288



Carlton

Montatura in metallo cromato o dorato. Elementi decorativi con catene di ottagoni e barre in cristallo molato trasparente.

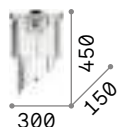

2,570 Kg / 0,0154 m³
E14 max 3x 40W

€ 165

168913 Cromo
213491 Oro

101224 3000 K
470 lm

€ 3,30



P. 198

P. 331



168913



213491

Dubai

Montatura in metallo con finitura cromo o ottone. Elementi decorativi con perle, ottagoni e prismi in cristallo molato trasparente.

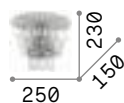

1,190 Kg / 0,0259 m³
E14 max 2x 40W

€ 209

207155 Cromo
201023 Ottone

101224 3000 K
470 lm

€ 3,30



P. 204

P. 329



207155



201023

Opera

Montatura in cromo. Paralume in lamina di PVC con riflessi metallizzati e rivestita da fili. Pendagli in cristallo molato.

LED Sorgente luminosa LED 3000 K, 15.000 h di durata.

ON OFF Lampada con interruttore integrato.

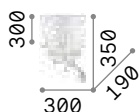

■ IP20

1,550 Kg / 0,0220 m³

E14 max 2x 40W +
LED 1W / 45 Lm

€ 170,50

068268 ■ Bianco

3000 K
420 Lm

101217 € 3,30



P. 190



P. 463



P. 503

Swan

Montatura in cromo. Corpo luce in vetro soffiato e lavorato a mano. Elementi decorativi in cristallo molato. Paralume in tessuto d'organza plissettato.

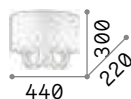

■ IP20

2,468 Kg / 0,0517 m³

E14 max 2x 40W

€ 205,70

035864 ■ Bianco

3000 K
420 Lm

101217 € 3,30



P. 191



Pegaso

Montatura in metallo cromato oppure ottone satinato. Corpo centrale, bobeches e pendagli in cristallo molato. Paralumi in organza.



■  IP20

1,600 Kg / 0,0302 m³

E14 max 2 x 40W

€ 154

059211  Bianco

197708  Ottone Satinato

 3000 K
370 lm

101231 € 3,30



P. 208



P. 467



P. 504

Corte

Montatura completamente in metallo modellato con lavorazione artigianale. Finitura dipinta a mano con effetto antichizzato. Disponibile nella versione bianca o ruggine.



■  IP20

1,060 Kg / 0,0329 m³

E14 max 2 x 40W

€ 79,20

028460  Bianco Antico

057200  Ruggine

 3000 K
470 lm

101224 € 3,30



P. 225



Negresco

Montatura in metallo con finitura in cromo o dorata. Bracci in vetro soffiato trasparente con interno dorato nella versione oro. Centrale composto da blocchi di cristallo molato. Elementi decorativi in vetro trasparente e cristallo molato.

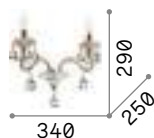

■ IP20

2,320 Kg / 0,0324 m³

E14 max 2x40W

€ 159,50

141046 Trasparen.

087757 Oro



141046



087757

3000 K
430 lm

101248

€ 3,30

[P. 214](#)



Florian

Montatura in metallo con elementi decorativi in vetro. Pendagli con ottagononi e gocce finali in cristallo molato. Disponibile nelle versioni con vetro trasparente e metallo dorato o cromato.

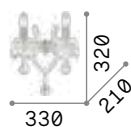

■ IP20

1,430 Kg / 0,0189 m³

E14 max 2x40W

€ 148,50

035642 Cromo

035659 Oro



035642



035659

3000 K
470 lm

101224

€ 3,30

[P. 218](#)



Gioconda

Corpo luce in fusione di metallo con finitura oro o argento antico. Pendagli ottagonali e tondi in cristallo molato.



IP20

1,310 Kg / 0,0111 m³

E14 max 2 x 40W

€ 214,50

044910 Argento

060491 Oro



3000 K
470 lm



101224 € 3,30

P. 222



044910



060491

Strauss

Montatura e dettagli in metallo con finitura oro rosa. Bracci in vetro soffiato trasparente. Elementi decorativi in cristallo ambrato.

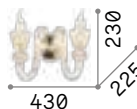

IP20

2,080 Kg / 0,0431 m³

E14 max 2 x 40W

€ 137,50

140599 Oro



3000 K
430 lm



101248 € 3,30

P. 226

Firenze

Corpo luce in resina. Bracci e foglie in metallo modellato artigianalmente. Decorato a mano con foglia d'oro e antichizzato.

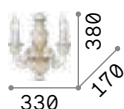

■  IP20

2,050 Kg / 0,0405 m³

E14 max 2x40W

€ 148,50

012902  Bianco Antico

020846  Oro

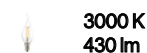

101248 € 3,30



P. 234



P. 461



P. 505



012902



020846

Chalet

Montatura con struttura portante in metallo. Elementi decorativi in resina lavorata artigianalmente e dipinta a mano come fedele riproduzione di corna e legno intagliato.

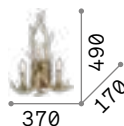

■  IP20

1,770 Kg / 0,0759 m³

E14 max 2x40W

€ 198

115511  Beige

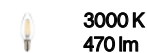

101224 € 3,30



P. 240



P. 460



Peter

Montatura in resina lavorata artigianalmente come fedele riproduzione del legno intagliato. Paralume in lamina di PVC rivestito in tessuto canvas.

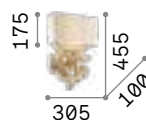

IP20

4,160 Kg / 0,0371 m³
E14 max 2 x 40W

€ 220

075211 Canvas



3000 K
480 lm

101200

€ 3,30



Harem

Montatura in metallo brunito con decori in rilievo e cristalli incastonati. Diffusore in vetro soffiato leggermente ambrato. Pendaglio a nappa.

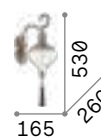

■ □ IP20

0,900 Kg / 0,0273 m³
E27 max 1x60W

€ 192,50

115962 ■ Brunito

● 3000 K
910 lm

119571 € 7,70



P. 238

Santa

Lampadario in vetro trasparente soffiato e lavorato a mano. Dettagli in metallo cromato. Versione oro disponibile con graniglia sul vetro.

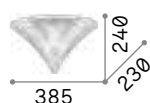

IP20

2,900 Kg / 0,0380 m³
E14 max 1x 40W

€ 214,50

087368 Trasparen.
087375 Oro

3000 K
470 lm

101224 € 3,30

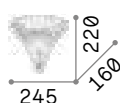

IP20

1,200 Kg / 0,0184 m³
E14 max 1x 40W

€ 93,50

013060 Trasparen.
013046 Oro

3000 K
470 lm

101224 € 3,30



087368



087375

Fiocco

Diffusore di vetro trasparente lavorato in piastra con graniglia. Decoro centrale color ambra. Viti fermavetro in ottone satinato.



IP20

1,800 Kg / 0,0265 m³
E27 max 1x 60W

€ 85,80

014630 Bianco

3000 K
430 lm

101279 € 3,30

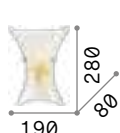

IP20

1,080 Kg / 0,0112 m³
E14 max 1x 40W

€ 59,40

014623 Bianco

3000 K
480 lm

101200 € 3,30



Stones

Montatura in metallo smaltato bianco. Diffusore interamente realizzato con elementi in alabastro naturale, aperto sulle estremità superiore e inferiore.



■ IP20

4,110 Kg / 0,0207 m³
E27 max 2x60W

€ 126,50

015132 ■ Alabastro

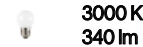

101286

€ 3,30

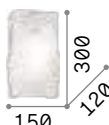

■ IP20

2,660 Kg / 0,0141 m³
E27 max 1x60W

€ 82,50

015125 ■ Alabastro

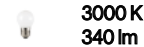

101286

€ 3,30



Scacchi

Montatura in metallo smaltato bianco. Diffusore interamente realizzato con elementi in alabastro naturale, aperto sulle estremità superiore e inferiore.



■ IP20

3,010 Kg / 0,0167 m³
E27 max 2x60W

€ 121

015118 ■ Alabastro

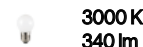

101286

€ 3,30

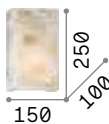

■ IP20

1,950 Kg / 0,0111 m³
E27 max 1x60W

€ 77

015101 ■ Alabastro

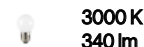

101286

€ 3,30





Carrara

Diffusore interamente realizzato con elementi in alabastro, aperto sulle estremità superiore e inferiore.



Lampadine LED G9 3W 3000 K incluse.
Cod. **209043**



230

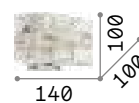

140



IP20



IP20

1,500 Kg / 0,0081 m³
G9 max 2 x 40W

1,200 Kg / 0,0049 m³
G9 max 1 x 40W

€ 100,10

€ 78,10

018775 ■ Alabastro

000619 ■ Alabastro

3000 K
370 lm

209043

€ 4,29

3000 K
370 lm

209043

€ 4,29



Interni

Lampade da tavolo



Birds

Pag 446















































Indice alfabetico

Alfiere	452	Oz	430
Axel	448	Paris	467
Birds	446	Pegaso	467
Birillo	443	Prato	444
Boulder	454	Queen	466
Candy	440	Rain	462
Cerchio	431	Roma	462
Chalet	460	Sally	437
Cupcake	444	Set Up	456
Dolomiti	454	Smarties	440
Driftwood	458	Snell	459
Duchessa	465	Truman	438
Edo	445	Wally	437
Eternity	453	Yoko	433
Firenze	461		
Futura	434		
Gru	432		
Hilton	451		
Kali	455		
Kate	464		
Kelly	436		
Lawyer	439		
Le Roy	466		
Lingotto	447		
London	449		
Luxury	450		
Mapa Bianco	441		
Mapa Max	442		
Microphone	446		
Nordik	450		
Opera	463		

Interni

Indice icone

				 new		 new
Oz 430	Cerchio 431	Gru 432	Yoko 433	Futura 434	Kelly 436	Sally 437
 new						
Wally 437	Truman 438	Lawyer 439	Smarties 440	Candy 440	MapaBianco 441	MapaMax 442
					 new	
Birillo 443	Prato 444	Cupcake 444	Edo 445	Microphone 446	Birds 446	Lingotto 447
 new						
Axel 448	London 449	Luxury 450	Nordik 450	Hilton 451	Alfiere 452	Eternity 453
						
Dolomiti 454	Boulder 454	Kali 455	Set Up 456	Driftwood 458	Snell 459	Chalet 460
						
Firenze 461	Roma 462	Rain 462	Opera 463	Kate 464	Duchessa 465	Queen 466
						
				Le Roy 466	Paris 467	Pegaso 467



Oz

Base e montatura in metallo verniciato a polveri o placcato. Cavi in pvc. Diffusore in gomma opale. Disponibile nelle finiture bianco, nero o ottone spazzolato.

LED Sorgente luminosa LED 3000 K, 30.000 h di durata.

ON OFF Lampada con interruttore integrato.

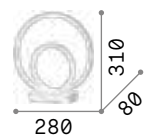

IP20

0,890 Kg / 0,0096 m³
LED 23W / 2000 lm

€ 187

269474 ■ Bianco
269481 ■ Nero
269498 ■ Ottone



P. 058

P. 259

P. 339



Cerchio

Corpo luce in metallo verniciato bianco o nero opaco. Diffusore in materiale plastico colore opale. Cavo in pvc con interruttore e alimentatore incorporati.

LED Sorgente luminosa LED 3000 K, 20.000 h di durata.

ON OFF Lampada con interruttore integrato.





Gru

Montatura interamente in metallo.
Asta con finitura in cromo. Base
e diffusore con finitura in vernice
opaca bianca o nera. Diffusore
ruotabile e regolabile in altezza.

LED Sorgente luminosa LED 3000 K,
15.000 h di durata.

**ON
OFF** Lampada con interruttore integrato.



147642



147659

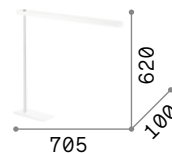

IP20

2,220 Kg / 0,0084 m³
LED 6,3W / 400 lm

€ 198

147642 ■ Bianco
147659 ■ Nero



Yoko

Base e montatura in metallo verniciato opaco. Diffusore in policarbonato opale. Cavo in pvc con presa-alimentatore. Colori: bianco o nero.

LED Sorgente luminosa LED 3000 K, 17.500 h di durata.

ON/OFF Lampada con interruttore integrato.



P. 077

P. 474



258881



258911



IP20

0,860 Kg / 0,247 m³
LED 5W / 430 lm

€ 95,70

258881 ■ Bianco
258911 ■ Nero



Futura ^{new}

Braccio in alluminio e plastica, snodato con cavo a vista in pvc. Diffusore orientabile a led e interruttore incorporato. Spina con alimentatore.

LED Sorgente luminosa LED 4000 K, 25.000 h di durata.

ON/OFF Lampada con interruttore integrato.

+ Lampada con dimmer.

Hand Lampada con dimmer tattile.

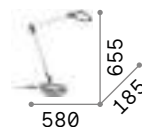

■ □ IP20 **Hand** **+**

1,830 Kg / 0,0069 m³
LED 10W / 750 lm

€ 137,50

272078 ■ Bianco ^{new}
204895 ■ Alluminio
204888 ■ Nero





Kelly

Lampada tecnica in metallo con
finitura bianco o nero opaco.
Braccio snodato e bilanciato a molle.
Diffusore orientabile.



Lampada con interruttore integrato.

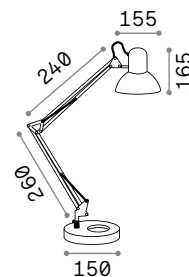

IP20

1,510 Kg / 0,0065 m³
E27 max 1 x 42W

€ 44

108117 ■ Bianco
108094 ■ Nero

3000 K
340 lm

101286 € 3,30



Sally ^{new}

Lampada tecnica in metallo con finitura bianco o nero opaco. Braccio snodato e bilanciato a molle. Diffusore orientabile.



Lampada con interruttore integrato.

Wally ^{new}

Lampada tecnica in metallo con finitura bianco o nero opaco. Braccio snodato e bilanciato a molle. Diffusore orientabile.



Lampada con interruttore integrato.



193946

265285

061160



2,600 Kg / 0,0132 m³
E27 max 1x 42W

€ 88

193946 ■ Bianco ^{new}
265285 ■ Nero ^{new}
061160 ■ Nero Rame

3000 K
900 lm

123899 € 7,70

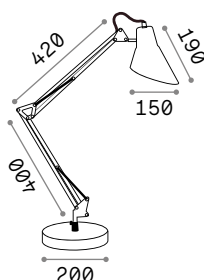

P. 483



193991

265278

061191



2,450 Kg / 0,0111 m³
E27 max 1x 42W

€ 88

193991 ■ Bianco ^{new}
265278 ■ Nero ^{new}
061191 ■ Nero Rame

3000 K
340 lm

101286 € 3,30

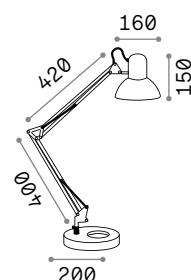

P. 482



Truman

Montatura e diffusore in metallo rifinito con vernice opaca bianca, grigia o nera. Braccio snodato con raccordi in metallo brunito. Diffusore smaltato bianco all'interno. Cavo rivestito in tessuto vintage bianco e nero.



Lampada con interruttore integrato.

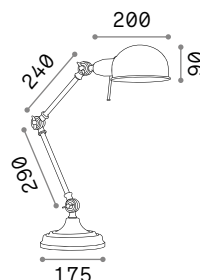

IP20

2,380 Kg / 0,0283 m³
E27 max 1x 60W

€ 88

145198 ■ Bianco

145204 ■ Grigio

145211 ■ Nero

3000 K
430 lm

101279 € 3,30



Lawyer

Montatura in metallo con finitura disponibile in ottone, in cromo o in brunito. Diffusore in vetro soffiato e incamiciato.



Lampada con interruttore integrato.

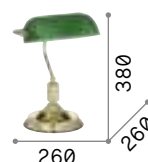

IP20

1,850 Kg / 0,0373 m³
E27 max 1x60W

€ 104,50

045047 Cromo
013657 Ottone
045030 Brunito



3000 K
910 lm

119571 € 7,70



Smarties

Base in metallo. Diffusore in vetro soffiato acidato. Cavo elettrico con spina e interruttore.

LED

Lampadine LED G9 3W 3000 K incluse.
Cod. **209043**

ON
OFF

Lampada con interruttore integrato.

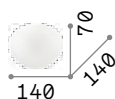

IP20

0,470 Kg / 0,0079 m³
G9 max 1x15W

€ 49,50

032078 **Bianco**

3000 K
370 Lm

209043

€ 4,29



P. 146



P. 279



P. 360

Candy

Montatura in metallo con finitura nickel satinato. Diffusore in vetro bianco soffiato e acidato.

LED

Lampadine LED G9 3W 3000 K incluse.
Cod. **209043**

ON
OFF

Lampada con interruttore integrato.

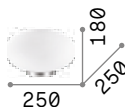

IP20

1,200 Kg / 0,0287 m³
G9 max 1x40W

€ 101,20

086804 **Bianco**

3000 K
370 Lm

209043

€ 4,29



P. 149



P. 281



Mapa Bianco

Base e sistema di fissaggio in metallo bianco. Diffusore a sfera in vetro bianco soffiato e acidato.



Lampada con interruttore integrato.



P. 156



P. 280



P. 360

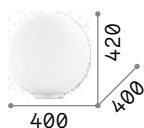

3,520 Kg / 0,1354 m³
E27 max 1x60W

€ 165

000206 Bianco

3000 K
910 lm

119571 € 7,70

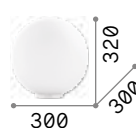

1,880 Kg / 0,0515 m³
E27 max 1x60W

€ 82,50

009131 Bianco

3000 K
910 lm

119571 € 7,70

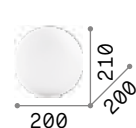

1,050 Kg / 0,0214 m³
E27 max 1x60W

€ 49,50

009155 Bianco

3000 K
910 lm

119571 € 7,70



Mapa Max

Montatura in metallo cromato.
Diffusore in vetro soffiato con
decorazione interna in filo
d'alluminio.



Lampada con interruttore integrato.

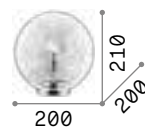

0,970 Kg / 0,0287 m³
E27 max 1x60W

€ 71,50

045139 Cromo

3000 K
910 lm

119571 € 7,70



P. 153



Birillo

Lampada da tavolo o da terra con base in metallo cromato e diffusore in vetro soffiato bianco e acidato o fumè.



Lampada con interruttore integrato.



000251



116570



2,310 Kg / 0,0454 m³
E27 max 1x60W

€ 148,50

000251 ■ Bianco
116587 ■ Fumè

3000 K
910 lm

119571 € 7,70



1,240 Kg / 0,0248 m³
E27 max 1x60W

€ 93,50

000268 ■ Bianco
116570 ■ Fumè

3000 K
910 lm

119571 € 7,70



Prato

Diffusore in vetro soffiato bianco incamiciato e acidato. Cavo elettrico con spina e interruttore.



Lampada con interruttore integrato.

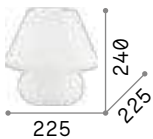

1,380 Kg / 0,0219 m³
E27 max 1x 60W

€ 77

074702 Bianco

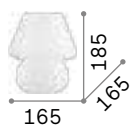

0,650 Kg / 0,0099 m³
E14 max 1x 40W

€ 49,50

074726 Bianco

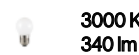

101286

€ 3,30

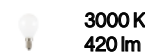

101217

€ 3,30



Cupcake

Base in resina smaltata bianca o rosa. Diffusore in vetro bianco soffiato e acidato. Cavo di alimentazione con interruttore.



Lampadine LED GX53 9W
3000 K incluse. Cod. **123936**



Lampada con interruttore integrato.

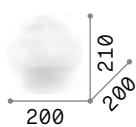

1,120 Kg / 0,0270 m³
GX53 max 1x 15W

€ 99

248479 Bianco

248486 Rosa

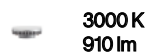

123936

€ 7,15



248479



248486



Edo

Montatura interna in metallo cromato. Diffusore in vetro bianco soffiato, incamiciato e acidato.



Lampada con interruttore integrato.



■ □ IP20

1,150 Kg / 0,0172 m³
E27 max 1x60W

€ 66

044590 ■ Bianco

● 3000 K
900 lm

123899 € 7,70

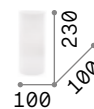

■ □ IP20

0,730 Kg / 0,0082 m³
E27 max 1x60W

€ 49,50

044606 ■ Bianco

● 3000 K
340 lm

101286 € 3,30



Microphone

Base e montatura in metallo verniciato a polveri bianco, nero o placcato ottone. Cavo rivestito in tessuto con interruttore incorporato.

LED Lampadine LED E27 8W Globo D95 3000 K incluse. Cod. **101323**

ON OFF Lampada con interruttore integrato.

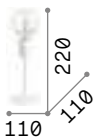

IP20
0,490 Kg / 0,0042 m³
E27 max 1x 60W

€ 77

232508 ■ Bianco
232485 ■ Nero
232546 ■ Ottone

3000 K
1120 lm

101323

€ 8,25

P. 476



232508

232485

232546



Birds ^{new}

Montatura in metallo verniciato con disco decorativo in ottone satinato. Diffusori in vetro soffiato bianco acidato. Cavo in pvc con interruttore e spina. Colore: nero opaco con dettaglio ottone satinato.

LED Lampadine LED G9 3W 3000 K incluse. Cod. **209043**

ON OFF Lampada con interruttore integrato.

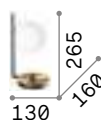

IP20

0,900 Kg / 0,0163 m³
G9 max 1x 15W

€ 82,50

273679 ■ Nero ^{new}

3000 K
370 lm

209043

€ 4,29

P. 090

P. 309

P. 395

P. 472





Lingotto

Base e montatura in metallo verniciato opaco. Cavo in pvc nero con interruttore. Diffusore in vetro soffiato bianco e acidato. Colore nero e oro metallizzato.

LED

Lampadine LED G9 3W 3000 K incluse nel modello **259222**. Cod. **209043**

**ON
OFF**

Lampada con interruttore integrato.



P. 088

P. 314



IP20

1,320 Kg / 0,0199 m³
E14 max 1x 40W

€ 122,10

251127 **Ottone**

3000 K
420 lm

101217

€ 3,30



IP20 INCLUSA

0,750 Kg / 0,0084 m³
G9 max 1x 28W

€ 86,90

259222 **Ottone**

3000 K
370 lm

209043

€ 4,29



Axel new

Base e raccordi in metallo verniciato a polveri. Stelo in legno naturale. Paralume regolabile in altezza, in pvc rivestito di tessuto. Cavo in pvc con interruttore. Colori: bianco o nero.



Lampada con interruttore integrato.

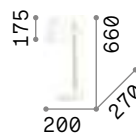

IP20

1,920 Kg / 0,0185 m³
E27 max 1x60W

€ 132

282091 ■ Bianco new
272238 ■ Nero new

3000 K
910 lm

119571 € 7,70



P. 491



London

Montatura in metallo rifinito in cromo o con vernice opaca bianca o nera. Paralume in lamina di PVC rivestito di tessuto, per la versione cromo in lamina di PVC cromata e semi trasparente.



Lampada con interruttore integrato.



110530



032368



110554

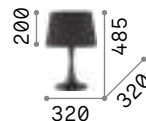

IP20

1,910 Kg / 0,0645 m³
E27 max 1x60W

€ 110

110448 ■ Bianco
032375 ■ Cromo
110455 ■ Nero

3000 K
910 lm

119571 € 7,70

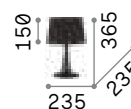

IP20

1,270 Kg / 0,0253 m³
E27 max 1x60W

€ 77

110530 ■ Bianco
032368 ■ Cromo
110554 ■ Nero

3000 K
910 lm

119571 € 7,70



P. 182



P. 495



Nordik

Montatura in metallo verniciato nero opaco. Paralume in lamina di PVC dorato rivestito in tessuto nero.

 Lampada con interruttore integrato.

Luxury

Montatura in metallo rifinita in ottone o cromo. Base nera opaca. Paralume in pvc con bordi in tessuto.

 Lampada con interruttore integrato.

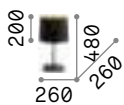

1,220 Kg / 0,0504 m³
E27 max 1x60W

€ 110

161686 ■ Nero

 3000 K
910 lm

119571

€ 7,70



P. 182



P. 410



P. 498

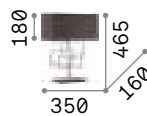

2,890 Kg / 0,0333 m³
E27 max 1x60W

€ 308

201078 ■ Cromo
201115 ■ Ottone

 3000 K
910 lm

119571

€ 7,70



201078

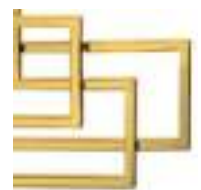

201115



P. 410



P. 499



Hilton

Montatura in cromo. Paralume in lamina di PVC rivestita in tessuto. Sul fondo, diffusore in vetro trasparente sabbiato.

LED

Lampadine LED G9 3W 3000 K incluse nel modello **075525**. Cod. **209043**

ON OFF

Lampada con interruttore integrato.



P. 185

P. 408

P. 501

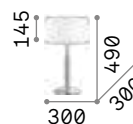

IP20

2,180 Kg / 0,0431 m³
E14 max 2x40W

€ 154

075532 Bianco

3000 K
420 Lm

101217

€ 3,30

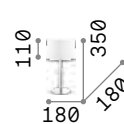

IP20

0,830 Kg / 0,0109 m³
G9 max 1x40W

€ 104,50

075525 Bianco

3000 K
370 lm

209043

€ 4,29



Alfiere

Base in metallo cromato. Paralume in lamina di PVC ignifuga colore cromo e semitrasparente.



Lampada con interruttore integrato.

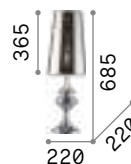

IP20

1,230 Kg / 0,0276 m³
E27 max 1x 60W

€ 121

032436 Cromo

3000 K
910 lm

119571 € 7,70

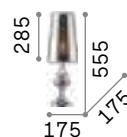

IP20

0,920 Kg / 0,0139 m³
E27 max 1x 60W

€ 99

032467 Cromo

3000 K
910 lm

119571 € 7,70



Eternity

Base in fusione di metallo. Finitura cromo con paralume di organza plissettata e riflessi metallizzati.



Lampada con interruttore integrato.

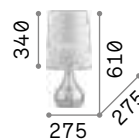

■ □ IP20

1,720 Kg / 0,0378 m³
E27 max 1x60W

€ 121

036007 ■ Argento

● 3000 K
900 lm

123899 € 7,70

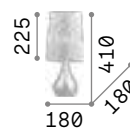

■ □ IP20

0,770 Kg / 0,0128 m³
E14 max 1x40W

€ 71,50

035987 ■ Argento

● 3000 K
420 lm

101217 € 3,30



Dolomiti

Corpo luce con elementi in ceramica smaltati. Dettagli metallici in nickel satinato. Paralume in lamina di PVC rivestita di tessuto tipo lino di colore beige.



Lampada con interruttore integrato.

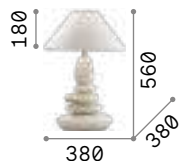

■ □ IP20

4,620 Kg / 0,1108 m³
E27 max 1x60W

€ 159,50

034942 ■ Pietra

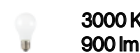

123899 € 7,70

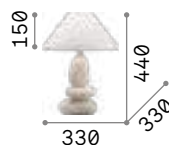

■ □ IP20

2,300 Kg / 0,0643 m³
E27 max 1x60W

€ 104,50

034935 ■ Pietra

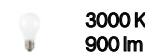

123899 € 7,70



Boulder

Base in cemento lavorato artigianalmente. Paralume in pvc rivestito con tessuto. Cavo in tessuto con interruttore.



Lampada con interruttore integrato.



■ □ IP20

4,790 Kg / 0,0833 m³
E27 max 1x60W

€ 148,50

238128 ■ Cemento

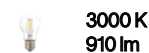

119571 € 7,70



Kali

Corpo luce in ceramica con decori in rilievo. Paralume in pvc rivestito con tessuto. Cavo in pvc con interruttore integrato.



Lampada con interruttore integrato.

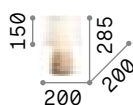

■ □ IP20

0,660 Kg / 0,0092 m³
E14 max 1x40W

€ 27,50

245331 ■ Bianco

● 3000 K
420 lm
101217 € 3,30

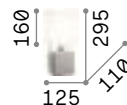

■ □ IP20

0,620 Kg / 0,0036 m³
E14 max 1x40W

€ 27,50

245348 ■ Bianco

● 3000 K
420 lm
101217 € 3,30

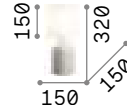

■ □ IP20

0,660 Kg / 0,0055 m³
E14 max 1x40W

€ 27,50

245393 ■ Bianco

● 3000 K
420 lm
101217 € 3,30



P. 188 P. 406 P. 496

Set up

Montature in metallo verniciato a polveri o placcato. Paralumi in pvc ignifugo rivestito di tessuto. Colori montature: bianco, nero oppure nichel satinato o ottone spazzolato. Colori paralumi: beige, bianco o nero.



Lampada con interruttore integrato.



259918

259949

259925

259956

260068

260075

260082



1,130 Kg / 0,0055 m³
E27 max 1x60W

€ 77

259918 Bianco
259949 Nickel
259925 Nero
259956 Oro

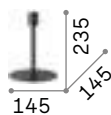

0,680 Kg / 0,0061 m³
E27 max 1x60W

€ 60,50

259864 Bianco
259895 Nickel
259871 Nero
259901 Oro

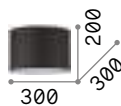

0,023 Kg / 0,0238 m³

€ 55

260433 Bianco
270005 Nero
260440 Beige

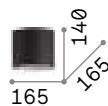

0,012 Kg / 0,0180 m³

€ 27,50

260327 Bianco
269986 Nero
260334 Beige



0,013 Kg / 0,0180 m³

€ 27,50

260068 Bianco
260075 Nero
260082 Beige

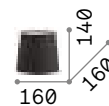

0,011 Kg / 0,0180 m³

€ 24,20

260341 Bianco
270036 Nero
260358 Beige

3000 K
900 lm
123899 € 7,70

3000 K
900 lm
123899 € 7,70



Driftwood

Montatura in metallo. Elementi decorativi con rami di legno naturale. Diffusore in lamina di pvc rivestito con tessuto canvas.



Lampada con interruttore integrato.

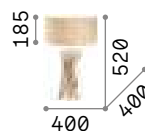

IP20

2,450 Kg / 0,0709 m³
E27 max 1x60W

€ 242

129570 Legno

2200 K
370 Lm

151687 € 6,05



P. 241

P. 492



Snell

Base in legno naturale. Corpo luce formato da rami veri. Paralume in lamina di pvc rivestita di tessuto.



Lampada con interruttore integrato.

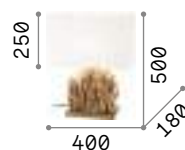

■ □ IP20

1,400 Kg / 0,0733 m³
E27 max 1x60W

€ 247,50

201399 ■ Bianco

● 3000 K
900 lm

123899 € 7,70

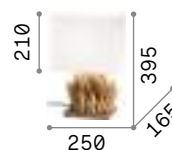

■ □ IP20

1,290 Kg / 0,0389 m³
E27 max 1x60W

€ 209

201382 ■ Bianco

● 3000 K
900 lm

123899 € 7,70



Chalet

Montatura con struttura portante in metallo. Elementi decorativi in resina lavorata artigianalmente e dipinta a mano come fedele riproduzione di corna e legno intagliato.



Lampada con interruttore integrato.



P. 240



P. 420

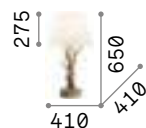

3,500 Kg / 0,1650 m³
E27 max 1x60W

€ 264

128207 ■ Beige

3000 K
910 lm

119571 € 7,70



Firenze

Corpo luce in resina. Bracci e foglie in metallo modellato artigianalmente. Decorato a mano con foglia d'oro e antichizzato.



Lampada con interruttore integrato.



012889



020853

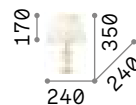

IP20

1,220 Kg / 0,0216 m³

E14 max 1x 40W

€ 132

012889 Bianco Antico

020853 Oro

 3000 K
480 lm

101200 € 3,30



P. 234



P. 420



P. 505



Roma

Montatura e dettagli in metallo cromato. Diffusore con elementi quadrati in cristallo molato sulla fascia laterale e vetro sabbato sul fondo.

LED

Lampadine LED G9 3W 3000 K incluse.
Cod. **209043**

**ON
OFF**

Lampada con interruttore integrato.

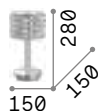

IP20

1,930 Kg / 0,0182 m³
G9 max 1x40W

€ 143

114620 Cromo



3000 K
370 lm

209043

€ 4,29



P. 199



P. 318



P. 414



IP20

2,030 Kg / 0,0249 m³
E14 max 2x40W

€ 143

008356 Cromo



3000 K
470 lm

101224

€ 3,30



P. 194



P. 330



Opera

Montatura in cromo. Paralume in lamina di PVC con riflessi metallizzati e rivestita da fili. Pendagli in cristallo molato.



Lampada con interruttore integrato.

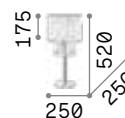

IP20

1,750 Kg / 0,0392 m³
E27 max 1x60W

€ 143

068305 Bianco

3000 K
900 lm

123899 € 7,70



P. 190

P. 416

P. 503



Kate

Corpo luce con elementi di cristallo trasparente molato. Paralumi in tessuto doppio, plissettato.



Lampada con interruttore integrato.



122878

122885

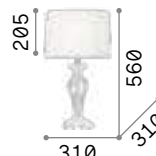
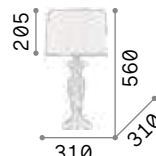

IP20

IP20

2,990 Kg / 0,0605 m³
E27 max 1x 60W

2,810 Kg / 0,0605 m³
E27 max 1x 60W

€ 275

€ 275

122878 Bianco

122885 Bianco

3000 K
900 lm

3000 K
900 lm

123899 € 7,70

123899 € 7,70



Duchessa

Base e dettagli in metallo cromato.
Elementi decorativi in vetro soffiato
e lavorato a mano. Paralume in
tessuto di organza plissettato.



Lampada con interruttore integrato.

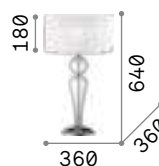

■ □ IP20

3,000 Kg / 0,0652 m³
E27 max 1x60W

€ 154

044491 ■ Trasparen.

● 3000 K
900 lm

123899 € 7,70



■ □ IP20

1,900 Kg / 0,0610 m³
E27 max 1x60W

€ 132

051406 ■ Trasparen.

● 3000 K
900 lm

123899 € 7,70

Queen

Montatura in metallo dorato con elementi decorativi e base in cristallo molato. Paralume in lamina di PVC, rivestita in tessuto con decorazione trapuntata e brillantini dorati.



Lampada con interruttore integrato.

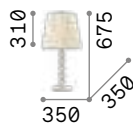

■ □ IP20

2,300 Kg / 0,0886 m³
E27 max 1x60W

€ 203,50

077758 ■ Oro

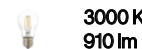

3000 K
910 lm

119571 € 7,70

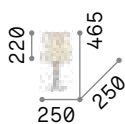

■ □ IP20

1,360 Kg / 0,0460 m³
E27 max 1x60W

€ 137,50

077741 ■ Oro

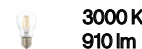

3000 K
910 lm

119571 € 7,70

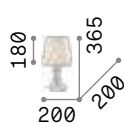

■ □ IP20

0,900 Kg / 0,0137 m³
E27 max 1x60W

€ 121

077734 ■ Oro

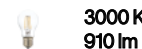

3000 K
910 lm

119571 € 7,70



P. 504

Le Roy

Montatura e base in metallo cromato con elementi decorativi in cristallo molato. Paralume in lamina di PVC, rivestita in tessuto con decorazione trapuntata e brillantini argentati.



Lampada con interruttore integrato.

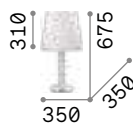

■ □ IP20

2,300 Kg / 0,0919 m³
E27 max 1x60W

€ 192,50

073408 ■ Cromo

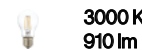

3000 K
910 lm

119571 € 7,70

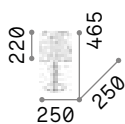

■ □ IP20

1,360 Kg / 0,0456 m³
E27 max 1x60W

€ 126,50

073422 ■ Cromo

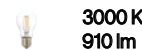

3000 K
910 lm

119571 € 7,70

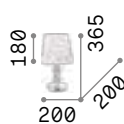

■ □ IP20

0,900 Kg / 0,0234 m³
E27 max 1x60W

€ 110

073439 ■ Cromo

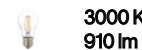

3000 K
910 lm

119571 € 7,70

Paris

Montatura in nickel satinato.
Bobeches in cristallo molato.
Paralume in lamina di PVC rivestita
da fili argentati.



Lampada con interruttore integrato.

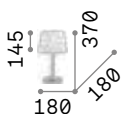

IP20

0,860 Kg / 0,0143 m³

E14 max 1x40W

€ 93,50

015965 Argento



3000 K
480 lm

101200 € 3,30



Pegaso

Montatura in metallo cromato
oppure ottone satinato. Corpo
centrale, bobeches e pendagli
in cristallo molato. Paralumi in
organza.



Lampada con interruttore integrato.

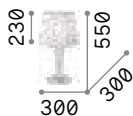

IP20

2,000 Kg / 0,0705 m³

E27 max 1x60W

€ 203,50

059259 Bianco



3000 K
900 lm

123899 € 7,70

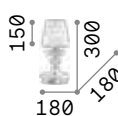

IP20

1,450 Kg / 0,0117 m³

E14 max 1x40W

€ 105,60

059266 Bianco
197753 Ottone Satinato



3000 K
420 lm

101217 € 3,30



P. 208



P. 417



P. 504



059266



197753



Interni

Lampade da terra



Indice alfabetico

Axel	491	Pegaso	504
Birds	472	Polly	480
Colonna	500	Provence	505
Cylinder	498	Queen	504
Daddy	488	Regol	494
Diesis	477	Sally	483
Dorothy	503	Set Up	496
Dorsale	486	Stage	484
Driftwood	492	Stand Up	475
Elvis	479	Wally	482
Eminent	490	Yoko	474
Firenze	505	York	493
Forcola	502		
Futura	481		
Hilton	501		
Klimt	493		
Kraken	485		
London	495		
Luxury	499		
Microphone	476		
Minimal	476		
Newton	478		
Nordik	498		
Opera	503		
Pagoda	489		



Wally

Pag 482



new



Birds 472



Yoko 474



Stand Up 475

new



Wally 482

new



Sally 483



Stage 484

new



Axel 491



Driftwood 492



York 493



Colonna 500



Hilton 501

Interni

Indice icone



Minimal 476 Microphone 476 **new** Diesis 477 Newton 478 Elvis 479 Polly 480 **new** Futura 481



Kraken 485 Dorsale 486 Daddy 488 Pagoda 489 Eminent 490



Klimt 493 Regol 494 London 495 Set Up 496 Cylinder 498 Nordik 498 Luxury 499



Forcola 502 Dorothy 503 Opera 503 Queen 504 Pegaso 504 Provence 505 Firenze 505



Birds new

Montatura in metallo verniciato con disco decorativo in ottone satinato. Diffusori in vetro soffiato bianco acidato. Cavo in pvc con interruttore e spina. Colore: nero opaco con dettaglio ottone satinato.

LED Lampadine LED G9 3W 3000 K incluse.
Cod. **209043**

ON
OFF Lampada con interruttore integrato.

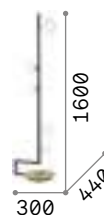

IP20 INCLUSA

5,640 Kg / 0,1536 m³
G9 max 5 x 15W

€ 330

273662 ■ Nero new

3000 K
370 lm

209043

€ 4,29



P. 090



P. 309



P. 395



P. 446



Yoko

Base e montatura in metallo verniciato opaco. Diffusore in policarbonato opale. Cavo in pvc con presa-alimentatore. Colori: bianco o nero.

LED Sorgente luminosa LED 3000 K, 17.500 h di durata.

ON OFF Lampada con interruttore integrato.

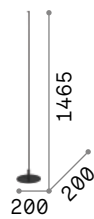
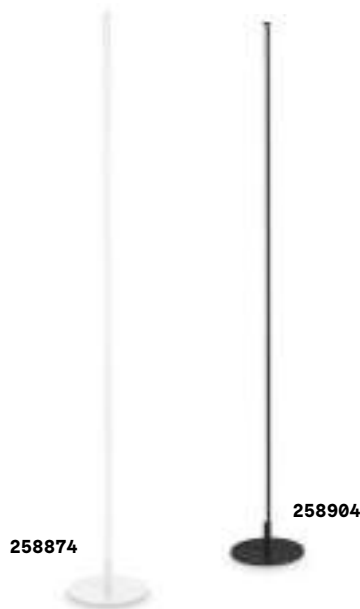
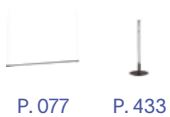

IP20

1,650 Kg / 0,0534 m³
LED 17W / 1500 lm

€ 176

258874 ■ Bianco
258904 ■ Nero



Stand Up

Montatura in metallo con finitura in cromo. Diffusore in vetro pirex smerigliato nella parte centrale.

LED Lampadine LED R7s 7W 118 mm
3000 K incluse. Cod. **189093**

ON/OFF Lampada con interruttore integrato.



4,130 Kg / 0,0233 m³
R7s max 1x150W

€ 187

027289 Bianco

3000 K
560 lm

189093 €20,35



Minimal

Montatura in metallo rifinito in smalto colorato nero. Cavo elettrico con rivestimento in tessuto.

LED Lampadine LED E27 8W Globo D125 trasparente 3000 K incluse. Cod. **101347**

ON OFF Lampada con interruttore integrato.



IP20  

5,840 Kg / 0,0806 m³
E27 max 1x60W

€ 192,50

163369 ■ Nero

 **3000 K**
1020 lm

101347

€ 9,35

[P. 108](#)

[P. 392](#)

Microphone

Base e montatura in metallo verniciato a polveri bianco, nero o placcato ottone. Cavo rivestito in tessuto.

LED Lampadine LED E27 8W Globo D125 trasparente 3000 K incluse. Cod. **101347**

ON OFF Lampada con interruttore integrato.



IP20  

2,320 Kg / 0,0425 m³
E27 max 1x60W

€ 181,50

232362 ■ Bianco

232331 ■ Nero

232409 ■ Ottone

 **3000 K**
1020 lm

101347

€ 9,35

[P. 446](#)



Diesis new

Montatura in metallo verniciato a polveri o placcato. Diffusore orientabile in rotazione e inclinazione. Cavo in pvc con interruttore. Colori: nero, nichel satinato oppure ottone satinato.

LED Sorgente luminosa LED 3000 K, 20.000 h di durata.

ON/OFF Lampada con interruttore integrato.



285337

279800

285344

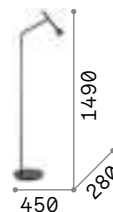

IP20

3,500 Kg / 0,0222 m³
LED 7W / 660 lm

€ 198

285337 **Nichel** new
279800 **Nero** new
285344 **Ottone Sat.** new





Newton

Montatura e diffusore in metallo.
Disponibile con finitura in nickel
satinato o con vernice nera opaca.
Braccio regolabile. Diffusore
orientabile smaltato bianco
all'interno.



Lampada con interruttore integrato.



P. 400



IP20

5,270 Kg / 0,0323 m³
E27 max 1x60W

€ 115,50

015286 ■ Nickel
003528 ■ Nero

3000 K
900 lm

123899 € 7,70



Elvis

Montatura in metallo cromato.
Diffusore orientabile in metallo
colorato e dettagli in cromo
all'esterno, smaltato bianco
all'interno.



Lampada con interruttore integrato.

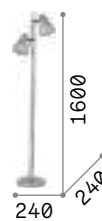

IP20

3,600 Kg / 0,0277 m³
E27 max 2 x 60W

€ 148,50

042794 ■ Argento
001197 ■ Nero

3000 K
910 lm

119571 € 7,70



Polly

Diffusori e base in metallo cromato, alluminio o smaltato nero. Dettagli e raccordi in metallo cromato. Diffusori orientabili.



Lampada con interruttore integrato.

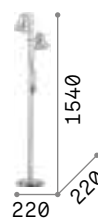

IP20

3,500 Kg / 0,0207 m³
E27 max 2x 60W

€ 115,50

061122 Cromo
061115 Alluminio
061139 Nero

3000 K
910 lm

119571 € 7,70



Futura ^{new}

Braccio in alluminio e plastica, snodato con cavo a vista in pvc. Diffusore orientabile a led e interruttore incorporato. Spina con alimentatore.

LED Sorgente luminosa LED 4000 K, 25.000 h di durata.

 Lampada con dimmer.

 Lampada con dimmer tattile.



P. 434





Wally new

Montatura e paralume in metallo verniciato a polveri con dettagli in metallo nichelato. Struttura a braccio articolato regolabile. Interruttore incorporato sulla testa del paralume. Cavo in pvc. Colori: bianco o nero.



Lampada con interruttore integrato.



265308



265292

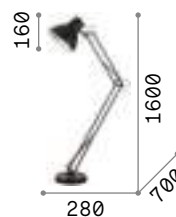

IP20

9,200 Kg / 0,0845 m³
E27 max 1 x 42W

€ 385

265308 Bianco new

265292 Nero new

3000 K
950 lm

101330 € 8,80



P. 437



Sally new

Montatura e paralume in metallo verniciato a polveri con dettagli in metallo nichelato. Struttura a braccio articolato regolabile. Interruttore incorporato sulla testa del paralume. Cavo in pvc. Colori: bianco o nero.



Lampada con interruttore integrato.



265322

265315

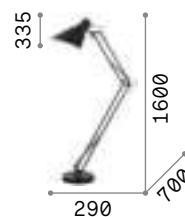

IP20

9,400 Kg / 0,0943 m³
E27 max 1x 42W

€ 385

265322 ■ Bianco new
265315 ■ Nero new

3000 K
950 lm

101330 € 8,80



P. 437



Stage

Corpo luce in metallo rifinito con vernice nera opaca. Treppiede con asta telescopica regolabile in altezza. Diffusore orientabile, decorato internamente in foglia oro.



Lampada con interruttore integrato.

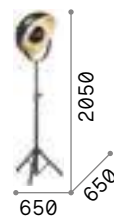

5,540 Kg / 0,163 m³
E27 max 1x60W

€ 401,50

132778 Oro

3000 K
910 lm

119571 € 7,70



Kraken

Treppiede in legno verniciato nero opaco. Dettagli e corpo luce in metallo cromato. Diffusore in vetro trasparente con alette interne per l'orientamento del flusso luminoso.



Lampada con interruttore integrato.

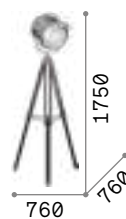

IP20

8,030 Kg / 0,0917 m³
E27 max 1x60W

€ 797,50

105659 Cromo

3000 K
1120 lm

101323 € 8,25



Dorsale

Montatura in metallo rifinito in cromo o con vernice opaca bianca o nera. Braccio a sezione quadrata composto da tre elementi. Paralume in lamina di PVC, disponibile in colore cromo o rivestita in tessuto bianco o nero.



Lampada con interruttore integrato.

046471



041742

046723

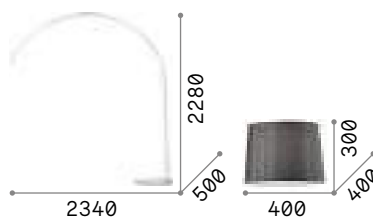
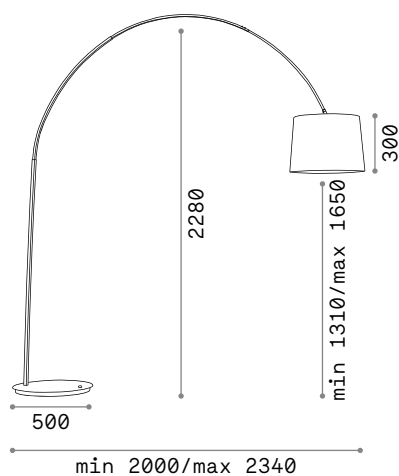

IP20

12,000 Kg / 0,0856 m³
E27 max 1x60W

0,430 Kg / 0,0708 m³

€ 599,50

€ 71,50

286686 ■ Bianco
286662 ■ Cromo
286679 ■ Nero

046723 ■ Bianco
041742 ■ Cromo
046471 ■ Nero

3000 K
1020 lm

101347 € 9,35



Daddy

Montatura in metallo. Disponibile in nero e bianco opaco con paralume rivestito in tessuto.

ON
OFF Lampada con interruttore integrato.

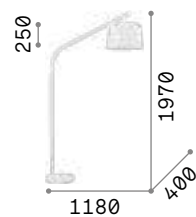

IP20

7,250 Kg / 0,1287 m³
E27 max 1 x 60W

€ 330

110356 ■ Bianco
110363 ■ Nero

3000 K
1020 lm

101347 € 9,35



Pagoda

Montatura e base in metallo rifinito con smalto satinato. Paralume a inclinazione regolabile rivestito di tessuto.



Lampada con interruttore integrato.

051741 051765 062273

260
 1840
 975 410

IP20

11,620 Kg / 0,1755 m³
 E27 max 1x60W

€ 385

051741 ■ Bianco
 062273 ■ Argento
 051765 ■ Nero

3000 K
 1020 lm
 101347 € 9,35



Eminent

Montatura in metallo verniciato a polveri di colore bianco o nero. Asta in legno naturale. Paralume in pvc rivestito con tessuto. Cavo rivestito in tessuto con interruttore.



Lampada con interruttore integrato.



207582



207599

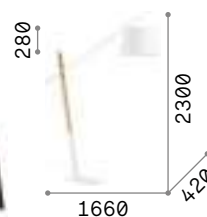

IP20

10,610 Kg / 0,1120 m³
E27 max 1 x 60W

€ 495

207582 ■ Bianco
207599 ■ Nero

3000 K
900 lm

101354 € 9,35



Axel **new**

Base e raccordi in metallo verniciato a polveri. Stelo in legno naturale. Paralume regolabile in altezza, in pvc rivestito di tessuto. Cavo in pvc con interruttore. Colori: bianco o nero.



Lampada con interruttore integrato.



P. 486



272245

282084

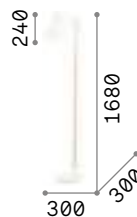

IP20

5,200 Kg / 0,0818 m³
E27 max 1x 60W

€ 220

272245 **Bianco** **new**
282084 **Nero** **new**

3000 K
1020 lm

101347 € 9,35



Driftwood

Montatura in metallo. Elementi decorativi con rami di legno naturale. Diffusore in lamina di pvc rivestito con tessuto canvas.

ON
OFF Lampada con interruttore integrato.

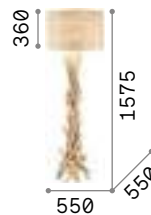

IP20

5,830 Kg / 0,3487 m³
E27 max 1x 60W

€ 632,50

148939 Legno

2200 K
370 lm

151687 € 6,05



IP20

24,000 Kg / 0,1753 m³
E27 max 2x 60W

€ 715

180946 Legno

2200 K
370 lm

151687 € 6,05



P. 241



P. 458



York

Base in legno naturale con dettagli in metallo. Paralume in lamina di pvc rivestito in tessuto. Cavo esterno in tessuto. Disponibile anche con montatura e paralume bianchi o neri.



Lampada con interruttore integrato.

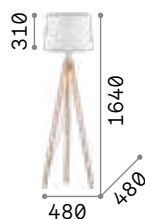

IP20

2,810 Kg / 0,0947 m³
E27 max 1x60W

€ 220

121406 ■ Bianco
121437 ■ Nero
089805 ■ Legno

3000 K
1020 lm

101347 € 9,35

Klimt

Treppiede in legno naturale. Paralume in lamina di pvc rivestita in tessuto e con supporto in metallo cromato.



Lampada con interruttore integrato.

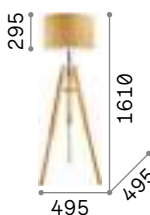

IP20

3,870 Kg / 0,1284 m³
E27 max 1x60W

€ 385

137827 ■ Legno

3000 K
1020 lm

101347 € 9,35



Regol

Montatura snodata in metallo.
 Diffusore regolabile ad altezze diverse. Disponibile con finitura nickel satinato e paralume rivestito in tessuto bianco.



Lampada con interruttore integrato.

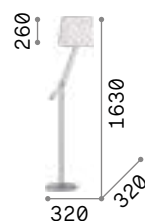

IP20

5,420 Kg / 0,0702 m³
 E27 max 1x60W

€ 275

014609 Bianco

3000 K
 1020 lm

101347 € 9,35



London

Montatura in metallo rifinito in cromo o con vernice opaca bianca o nera. Paralume in lamina di PVC rivestito di tessuto, per la versione cromo in lamina di PVC cromata e semi trasparente.



Lampada con interruttore integrato.



110233

032382

110240

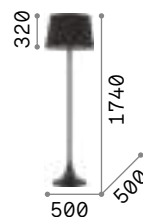

IP20

7,120 Kg / 0,1879 m³
E27 max 1x60W

€ 302,50

110233 ■ Bianco
032382 ■ Cromo
110240 ■ Nero

3000 K
1020 lm

101347

€ 9,35



P. 182



P. 449



Set up

Montature in metallo verniciato a polveri o placcato. Paralumi in pvc ignifugo rivestito di tessuto. Colori montature: bianco, nero oppure nichel satinato o ottone spazzolato. Colori paralumi: beige, bianco o nero.



Lampada con interruttore integrato.



259963

259994

259970

260006

260136

260235

260242



2,640 Kg / 0,0251 m³
E27 max 1x60W

€ 143

- 259963 ■ Bianco
- 259994 ■ Nickel
- 259970 ■ Nero
- 260006 ■ Ottone

0,047 Kg / 0,0768 m³

€ 82,50

- 260457 ■ Bianco
- 270012 ■ Nero
- 260464 ■ Beige

0,046 Kg / 0,0709 m³

€ 60,50

- 260136 ■ Bianco
- 260235 ■ Nero
- 260242 ■ Beige

3000 K
900 lm
123899 € 7,70



P. 188



P. 406



P. 456



Cylinder

Base in metallo verniciato bianco opaco. Diffusore in vetro soffiato bianco incamiciato e acidato.



Lampada con interruttore integrato.

Nordik

Montatura in metallo verniciato nero opaco. Paralume in lamina di PVC dorato rivestito in tessuto nero.



Lampada con interruttore integrato.

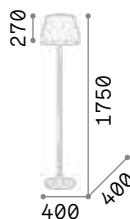

10,010 Kg / 0,1145 m³
E27 max 2x 60W

€ 258,50

111452 ■ Bianco

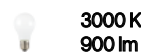

123899

€ 7,70



P. 183

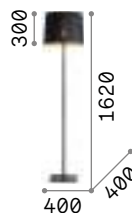

3,620 Kg / 0,0897 m³
E27 max 1x 60W

€ 236,50

161716 ■ Nero

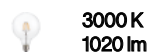

101347

€ 9,35



P. 182



P. 410



P. 450



Luxury

Montatura in metallo rifinita in ottone o cromo. Base nera opaca. Paralume in pvc con bordi in tessuto.



Lampada con interruttore integrato.

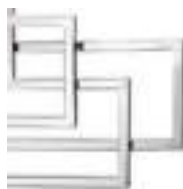

201085



201122

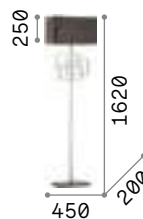

IP20

7,440 Kg / 0,2321 m³
E27 max 1x60W

€ 605

201085 Cromo
201122 Ottone

3000 K
1020 lm

101347 € 9,35



P. 410



P. 450



Colonna

Montatura in metallo verniciato bianco o nero opaco. Diffusore in acrilico. Cavo in tessuto. Lampadine a LED sostituibili.



Lampadine LED GX53 9W 3000 K incluse. Cod. **123936**



Lampada con interruttore integrato.



177199



177205



7,740 Kg / 0,0710 m³
GX53 max 4 x 15W

€ 330

177199 ■ Bianco
177205 ■ Nero

● **3000 K**
910 lm

123936 € **7,15**



Hilton

Montatura in cromo. Paralume in lamina di PVC rivestita in tessuto. Sul fondo, diffusore in vetro trasparente sabbato.



Lampada con interruttore integrato.



P. 185



P. 408



P. 451

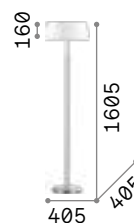

IP20

6,600 Kg / 0,0739 m³
E14 max 2 x 40W

€ 269,50

075488 Bianco

3000 K
420 lm

101217 € 3,30



Forcola

Montatura e dettagli in metallo cromato. Corpo luce in vetro trasparente soffiato e lavorato a mano. Diffusore in lamina di PVC rivestita di tessuto.



Lampada con interruttore integrato.

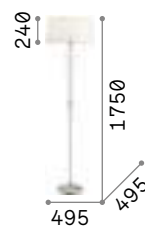

IP20

8,480 Kg / 0,2518 m³
E27 max 1x60W

€ 495

142616 Bianco

3000 K
900 lm

101354 € 9,35



Dorothy

Base e struttura centrale in metallo cromato. Elementi decorativi in vetro soffiato e lavorato a mano. Paralume in lamina di PVC, rivestita in tessuto.

 Lampada con interruttore integrato.

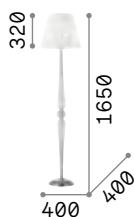

 IP20

5,040 Kg / 0,1879 m³
E27 max 1x60W

€ 341

035369  Trasparen.

 3000 K
900 lm

101354 € 9,35



Opera

Montatura in cromo. Paralume in lamina di PVC con riflessi metallizzati e rivestita da fili. Pendagli in cristallo molato.

 Lampada con interruttore integrato.

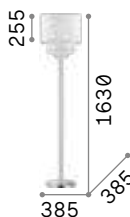

 IP20

5,720 Kg / 0,0770 m³
E27 max 1x60W

€ 297

068275  Bianco

 3000 K
900 lm

101354 € 9,35



P. 190



P. 416



P. 463



Queen

Montatura in metallo dorato con elementi decorativi e base in cristallo molato. Paralume in lamina di PVC, rivestita in tessuto con decorazione trapuntata e brillantini dorati.



Lampada con interruttore integrato.



4,900 Kg / 0,0979 m³
E27 max 1x60W

€ 352

077765 Oro

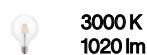

101347

€ 9,35



P. 466

Pegaso

Montatura in metallo cromato. Corpo centrale, bobeches e pendagli in cristallo molato. Paralumi in organza.



Lampada con interruttore integrato.

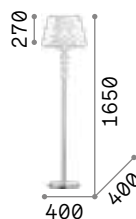

5,450 Kg / 0,0985 m³
E27 max 1x60W

€ 330

059228 Bianco

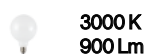

101354

€ 9,35



P. 208



P. 417



P. 467



Provence

Corpo luce in legno tornito e bracci in metallo. Finitura con vernice opaca. Paralumi in lamina di PVC rivestita in tessuto a trama grossa.



Lampada con interruttore integrato.



4,900 Kg / 0,0989 m³
E27 max 1x60W

€ 275

022987 ■ Bianco Antico

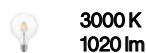

101347 € 9,35



P. 211

Firenze

Corpo luce in resina. Bracci e foglie in metallo modellato artigianalmente. Decorato a mano con foglia d'oro e antichizzato.



Lampada con interruttore integrato.

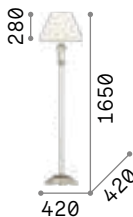

5,600 Kg / 0,1089 m³
E27 max 1x60W

€ 330

002880 ■ Bianco Antico
020877 ■ Oro

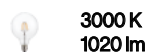

101347 € 9,35



002880



020877



P. 234



P. 420



P. 461



**GRA
PHI
DIA
LOG
UE**

A Dialogue of
Architecture
1950 - 1970

Edited by
John P. O'Shea
and
Richard
C. Long

Published by
The MIT Press
Cambridge, MA
London, England























Interni

Sistemi

Indice alfabetico

Arca	508
Ego	522
Fluo	542
Office	556
Slot	566
Steel	552
Tesi	558
Vision	560

Indice icone

				
Arca Track 510	Arca Accent 512	Arca Wide 514	Arca Pendant 516	
				
Ego Single 524	Ego Double 526	Ego Accent 528	Ego Wide 530	
				
Ego Pendant 532	Ego Wallwasher 532	Fluo Accent 544	Fluo Wide 546	Fluo Biemission 548
				
Steel Accent 554	Steel Wide 554	Office 556		
				
Tesi 558	Vision Trimless 562	Vision Trim 564		
				
Slot Recessed 568	Slot Surface 570	Slot Angular 572		

Arca **new**

Sistema lineare in alluminio estruso compatibile con un'ampia scelta di apparecchi illuminanti a fissaggio meccanico. Il sistema è anodizzato e verniciato. Disponibile in colore nero e nelle modalità d'installazione a plafone, a sospensione oppure a incasso a filo in soffitti di cartongesso. Moduli componibili a seconda della disposizione desiderata. Moduli track disponibili anche nella finitura ottone satinato. La sezione della scocca per le versioni a soffitto e a sospensione è larga 42 mm e alta 85 mm, mentre quella per la versione a incasso è larga 86 mm e alta 90 mm. Entrambi i modelli sono disponibili in due lunghezze: 1000 mm e 3000 mm. Possibilità di assemblaggio con diversi moduli sorgente: il modulo WIDE diffondente, il modulo ACCENT con controllo dell'UGR inferiore a 13, i moduli TRACK oppure PENDANT per un'illuminazione SPOT con differenti angoli di emissione. Il modulo CORNER per composizioni angolari. LED integrati, possibilità di temperatura di colore di 3000 K o di 4000 K, binning iniziale ≤ 3 -Step MacAdam, protezione IP20, classe isolamento III, durata utile LED 50.000 h L70B50. L'alimentazione in 48Vdc conferisce grande versatilità e sicurezza, con composizioni reversibili e modificabili all'occorrenza. Sistema adatto per ambienti dove viene richiesta un'illuminazione professionale dal design minimale, come ad esempio UFFICI e spazi COMMERCIALI.

PRO

Prodotto ad alto contenuto tecnologico, elevata qualità dei materiali, destinato ad uso professionale.

UGR

Articolo con UGR <13, <16 (Accent, Pendant).

Sorgente	LED COB / SMD
Driver incluso	No
Driver disponibili	On/Off
MacAdam	SDCM 3
CCT	3000K / 4000K
CRI	≥ 80
UGR	<13, <16 (Accent, Pendant)
Durata LED	50.000h
Classe isolamento	III
IP	20
Materiale	Alluminio
Garanzia	5 anni





Arca Track

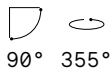
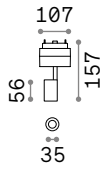

0,200 Kg/0,0015 m³

LED SMD CREE

Potenza	Angolo	Lumen	CCT	Finitura	Codice	€
5 W	34°	500 lm	3000 K	Nero	222974	104,50
				Ottone Sat.	281995	104,50 <i>new</i>
		530 lm	4000 K	Nero	223056	104,50



LENS

Necessario	Angolo	Codice	€
No	20°	223087	7,70

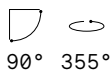
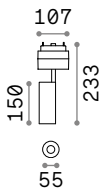

0,460 Kg/0,0030 m³

LED COB CITIZEN

Potenza	Angolo	Lumen	CCT	Finitura	Codice	€
14 W	36°	1400 lm	3000 K	Nero	222967	137,50
				Ottone Sat.	281988	137,50 <i>new</i>
		1500 lm	4000 K	Nero	223049	137,50



LENS

Necessario	Angolo	Codice	€
No	18°	223094	7,70



Light beam: ACCENT

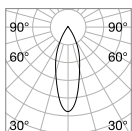

m	lx	Øm
1	553	0,58
2	138	1,16
3	61	1,75
4	35	2,33
5	22	2,91



CRI≥80 5,5W 34° 440lm 3000K

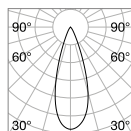

m	lx	Øm
1	2336	0,60
2	584	1,21
3	259	1,81
4	146	2,42
5	93	3,02



CRI≥80 14W 36° 1400lm 3000K



Arca Accent

LED SMD OSRAM UGR <13

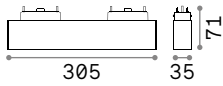

0,440 Kg/0,0026 m³

Potenza	Angolo	Lumen	CCT	Finitura	Codice	€
15W	35°	1700 lm	3000 K	Nero	222929	165
		1850 lm	4000 K	Nero	223001	165

LED SMD OSRAM UGR <13

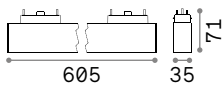

0,700 Kg/0,0087 m³

Potenza	Angolo	Lumen	CCT	Finitura	Codice	€
29W	35°	3200 lm	3000 K	Nero	222936	275
		3400 lm	4000 K	Nero	223018	275



Light beam: ACCENT

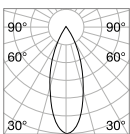

m	lx	Øm
1	2707	0,56
2	676	1,13
3	300	2,26
4	169	2,83
5	108	3,39



CRI≥90 15W 35° 1700lm 3000K

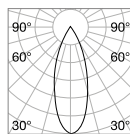

m	lx	Øm
1	4826	0,60
2	1207	1,21
3	536	1,81
4	301	2,42
5	193	3,02



CRI≥90 29W 35° 3200lm 3000K



Arca Accent 300 mm



Arca Accent 600 mm



Arca Wide

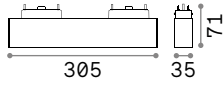

0,410 Kg/0,0025 m³

LED SMD SAMSUNG

Potenza	Angolo	Lumen	CCT	Finitura	Codice	€
13W	98°	1950 lm	3000 K	Nero	222943	99
		2100 lm	4000 K	Nero	223025	99

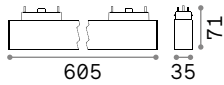

0,700 Kg/0,0087 m³

LED SMD SAMSUNG

Potenza	Angolo	Lumen	CCT	Finitura	Codice	€
25W	98°	4000 lm	3000 K	Nero	222950	143
		4300 lm	4000 K	Nero	223032	143



Light beam: WIDE

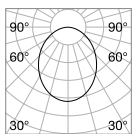

m	lx	Øm
1	203	2,16
2	50	4,33
3	22	6,50
4	12	8,66
5	8	10,83



CRI≥80 13W 98° 1950lm 3000K

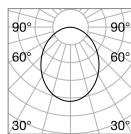

m	lx	Øm
1	440	2,14
2	110	4,28
3	48	6,42
4	27	8,56
5	17	10,70



CRI≥80 25W 98° 4000lm 3000K



Arca Wide 300 mm



Arca Wide 600 mm



Arca Pendant

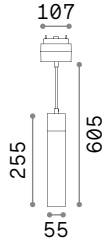

0,740 Kg/0,0056 m³

LED COB CITIZEN UGR <13

Potenza	Angolo	Lumen	CCT	Finitura	Codice	€
15 W	34°	1450 lm	3000 K	Nero	222981	165
		1500 lm	4000 K	Nero	223063	165

Lunghezza cavi 350 mm



LENS

Necessario	Angolo	Codice	€
No	18°	223285	7,70

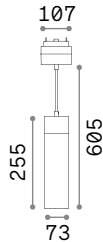

1,080 Kg/0,0056 m³

LED COB CITIZEN UGR <16

Potenza	Angolo	Lumen	CCT	Finitura	Codice	€
21 W	30°	2650 lm	3000 K	Nero	222998	187
		2800 lm	4000 K	Nero	223070	187

Lunghezza cavi 350 mm



LENS

Necessario	Angolo	Codice	€
No	15°	223292	7,70



Light beam: ACCENT

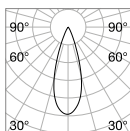

m	lx	Øm
1	2410	0,59
2	602	1,19
3	268	1,78
4	151	2,38
5	96	2,98

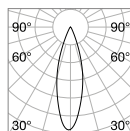

m	lx	Øm
1	4788	0,51
2	1197	1,03
3	532	1,55
4	299	2,06
5	191	2,58



CRI≥80 15W 34° 1450lm 3000K

CRI≥80 21W 30° 2650lm 3000K



Arca - Suspension

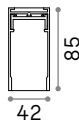
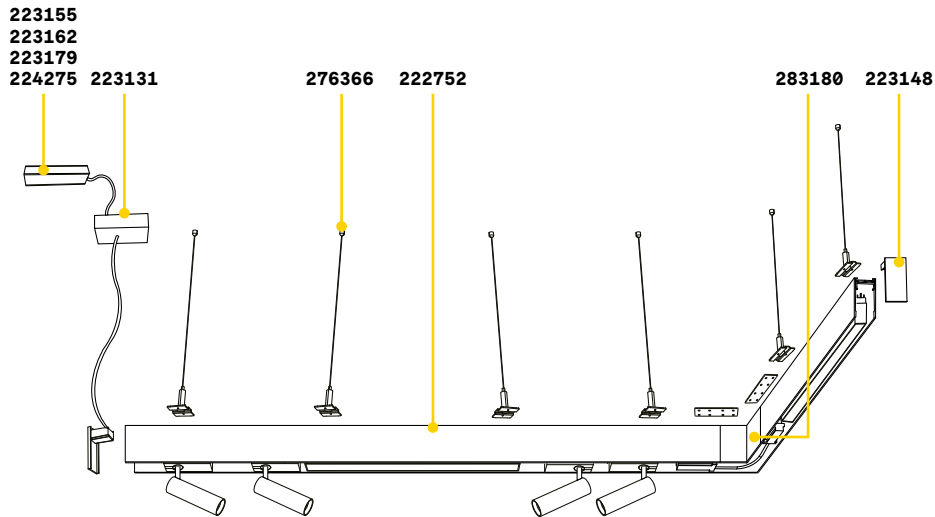

TRACK Lunghezza massima per punto di alimentazione: 25 metri

Lunghezza	Peso	Volume	Finitura	Codice	€
1000 mm	1,34 Kg	0,0273 m ³	Nero	222745	115,50
3000 mm	4,02 Kg	0,0600 m ³	Nero	222752	313,50

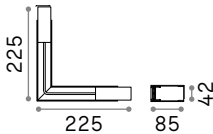

BLINDED CORNER RIGHT - LEFT Optional

Peso	Volume	Finitura	Codice	€
0,79 Kg	0,0090 m ³	Nero	283180	104,50



	Necessario	Lunghezza cavi	Misura (L x H x P)	Codice	€
LINEAR CONNECTOR	SI - 1 Kit x giunzione		100 x 18 x 38 mm	254944	24,20
ELECTRIFIED END CAP	SI - 1 kit x punto di alimentaz. max 210W	2150 mm	100 x 2270 x 53 mm	223131	38,50
END CAP	SI		20 x 85 x 42 mm	223148	15,40
SINGLE CABLE KIT	SI - 1 Kit x 1000 mm	2000 mm	15 x 2000 mm	276366	12,10

Arca - Surface

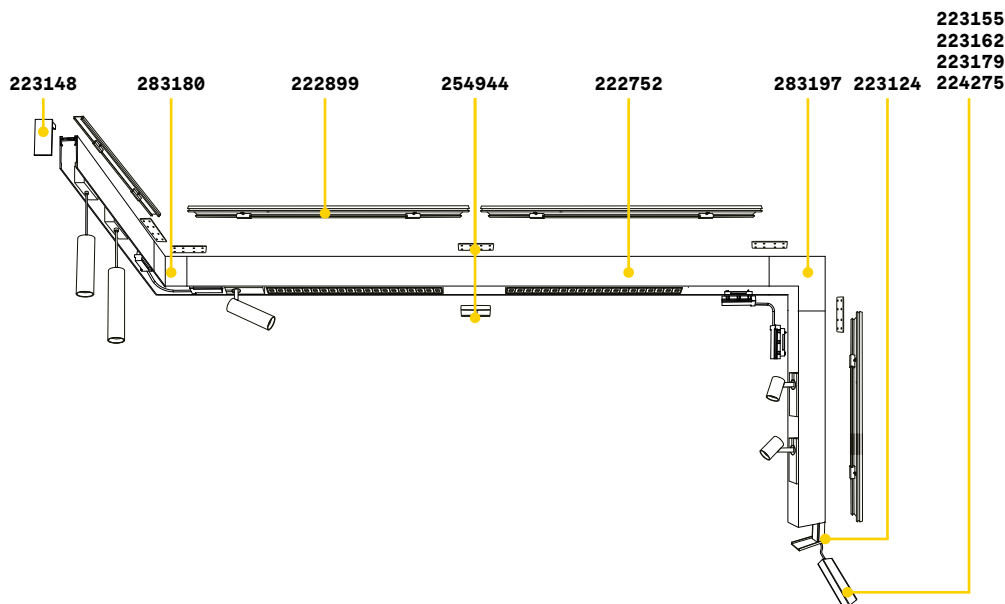

223155
223162
223179
224275

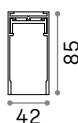

TRACK Lunghezza massima per punto di alimentazione: 25 metri

Lunghezza	Peso	Volume	Finitura	Codice	€
1000 mm	1,34 Kg	0,0273 m ³	Nero	222745	115,50
3000 mm	4,02 Kg	0,0600 m ³	Nero	222752	313,50

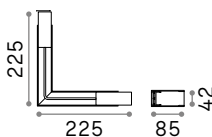

BLINDED CORNER RIGHT - LEFT Optional

Peso	Volume	Finitura	Codice	€
0,79 Kg	0,0090 m ³	Nero	283180	104,50

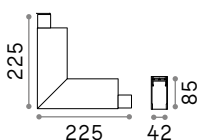

BLINDED CORNER VERTICAL - HORIZONTAL Optional

Peso	Volume	Finitura	Codice	€
0,79 Kg	0,0090 m ³	Nero	283197	104,50



LINEAR CONNECTOR

ELECTRIFIED END CAP

END CAP

KIT SURFACE

Necessario	Lunghezza cavi	Misura (L x H x P)	Codice	€
SI - 1 Kit x giunzione		100 x 18 x 38 mm	254944	24,20
SI - 1 kit x punto di alimentaz. max 210W	380 mm	86 x 80 x 42 mm	223124	22
SI		20 x 85 x 42 mm	223148	15,40
SI - 1 Kit x 1000 mm		1000 x 12 x 42 mm	222899	27,50

Arca - Recessed

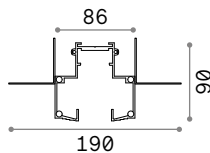
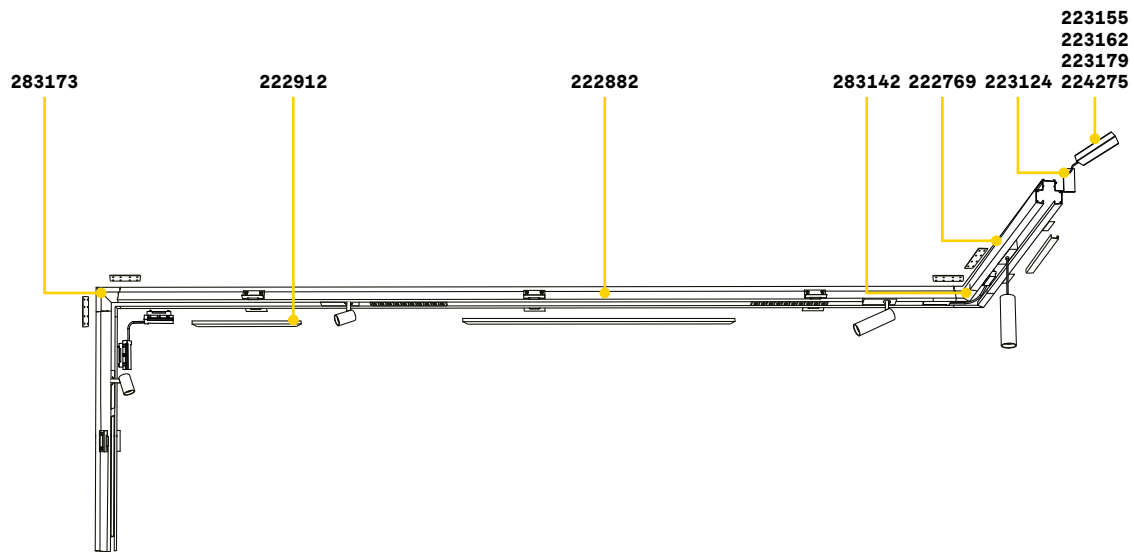

TRACK Kit per montaggio profilo e tappi di chiusura inclusi
Lunghezza massima per punto di alimentazione: 25 metri

Lunghezza	Peso	Volume	Finitura	Codice	€
1000 mm	2,90 Kg	0,0269 m ³	Nero	222769	181,50
3000 mm	8,70 Kg	0,0617 m ³	Nero	222882	473

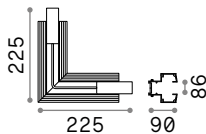

BLINDED CORNER RIGHT - LEFT Optional

Peso	Volume	Finitura	Codice	€
1,12 Kg	0,0090 m ³	Nero	283142	137,50

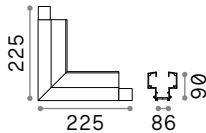

BLINDED CORNER VERTICAL - HORIZONTAL Optional

Peso	Volume	Finitura	Codice	€
1,12 Kg	0,0090 m ³	Nero	283173	137,50



LINEAR CONNECTOR

Necessario	Lunghezza cavi	Misura (L x H x P)	Codice	€
SI - 1 Kit x giunzione		100 x 18 x 38 mm	254944	24,20

ELECTRIFIED END CAP

SI - 1 kit x punto di alimentaz. max 210W	380 mm	86 x 80 x 42 mm	223124	22
-------------------------------------------	--------	-----------------	--------	----



Arca - Drivers and cover

DRIVER MEANWELL ON/OFF Necessario



Potenza	Output	Classe	Misura (L.xH.xP)	Codice	€
60 W	48 Vdc	⊕	171x62x37 mm	223155	132
90 W	48 Vdc	⊕	220x68x37 mm	223162	176
150 W	48 Vdc	⊕	228x68x37 mm	223179	198
240 W	48 Vdc	⊕	244x68x39 mm	224275	220

BLINDED COVER Optional



Materiale	Lunghezza	Colore	Codice	€
PC	990 mm	Nero	222912	7,70

Ego ^{new}

Sistema lineare composto da un profilo in alluminio estruso ed elementi di illuminazione a fissaggio magnetico con blocco meccanico di sicurezza. Il sistema è disponibile in colore nero, bianco oppure ottone satinato, nella modalità d'installazione a plafone, sospensione e incasso. La sezione del profilo è larga 26 mm e alta 27 mm o 52 mm, disponibile in due lunghezze 1000 mm e 2000 mm. Possibilità di assemblaggio con diversi moduli sorgente componibili a seconda della disposizione desiderata e modificabili all'occorrenza: i moduli TRACK SINGLE oppure DOUBLE per un'illuminazione spot, il modulo ACCENT con controllo dell'abbagliamento (UGR < 19), il modulo PENDANT TUBE per un'illuminazione localizzata e i moduli WIDE e WALL WASHER per un'illuminazione diffusa e uniforme. LED integrati con temperatura di colore di 3000 K e CRI 90, protezione IP20, classe isolamento III, alimentazione in 48 Vdc, durata utile LED 50.000 h L70B50; sistema disponibile anche in versione dimmerabile DALI. Ideale per l'illuminazione di piccoli e grandi ambienti dove viene richiesta ampia flessibilità e resa cromatica, ad esempio spazi MUSEALI, COMMERCIALI, RESIDENZIALI e RETAIL.

PRO

Prodotto ad alto contenuto tecnologico, elevata qualità dei materiali, destinato ad uso professionale.

UGR

Articolo con UGR <19 (Accent, Pendant).

Sorgente	LED COB / SMD
Driver incluso	No
Driver disponibili	On/Off
Controllo	On/Off / DALI
MacAdam	SDCM 3
CCT	3000K
CRI	≥90
UGR	<19 (Accent, Pendant)
Durata LED	50.000h
Classe isolamento	III
IP	20
Materiale	Alluminio
Garanzia	5 anni



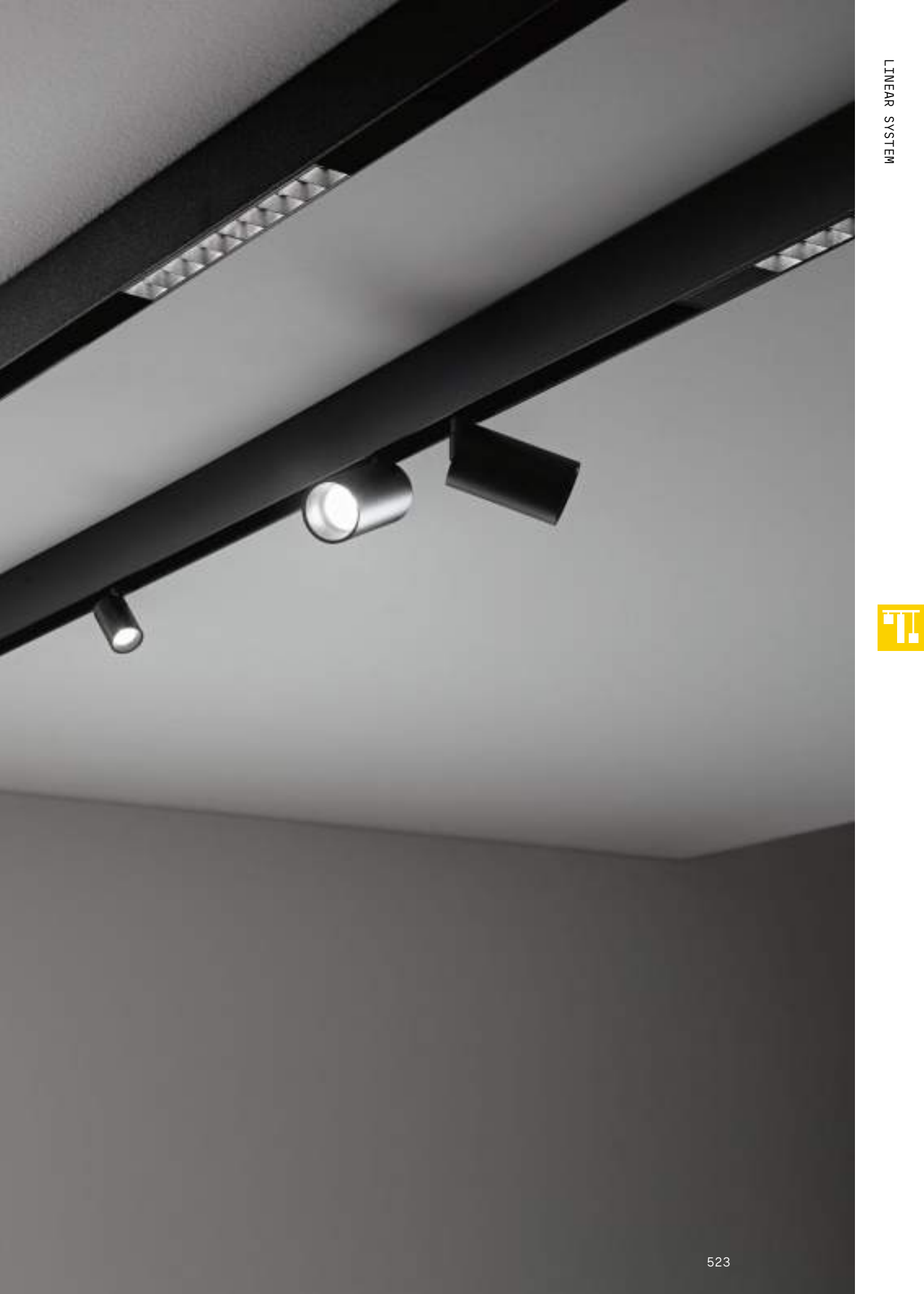

Ego Track Single

LED SMD OSRAM

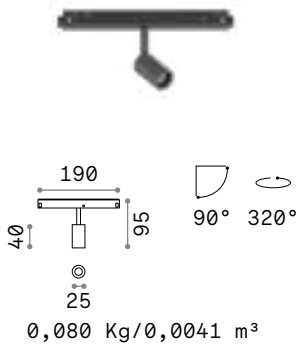

Potenza	Angolo	Lumen	CCT	Controllo	Finitura	Codice	€
3 W	30°	230 lm	3000 K	On-Off	Bianco	282978	82,50 <i>new</i>
					Nero	257617	82,50
					Ottone Sat.	282039	93,50 <i>new</i>
				DALI	Bianco	286402	137,50 <i>new</i>
					Nero	286396	137,50 <i>new</i>

LED COB CITIZEN

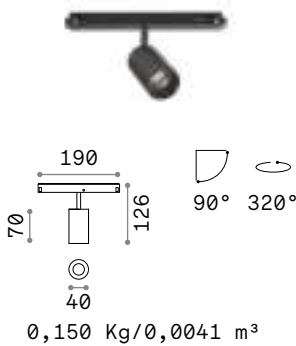

Potenza	Angolo	Lumen	CCT	Controllo	Finitura	Codice	€
8 W	30°	750 lm	3000 K	On-Off	Bianco	282985	104,50 <i>new</i>
					Nero	257631	104,50
					Ottone Sat.	282046	110 <i>new</i>
				DALI	Bianco	286426	154 <i>new</i>
					Nero	286419	154 <i>new</i>

LED COB CITIZEN

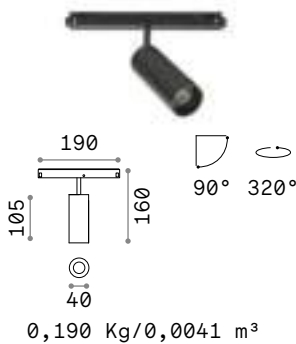

Potenza	Angolo	Lumen	CCT	Controllo	Finitura	Codice	€
12 W	30°	1000 lm	3000 K	On-Off	Bianco	282992	110 <i>new</i>
					Nero	257655	110
					Ottone Sat.	282053	115,50 <i>new</i>
				DALI	Bianco	286440	159,50 <i>new</i>
					Nero	286433	159,50 <i>new</i>



FILTER HONEYCOMB

Modello	Necessario	Codice	€
Ego 3W	No	260853	4,40
Ego 8W	No	260860	4,40
Ego 12W	No	260860	4,40



Light beam: ACCENT

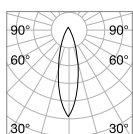

m	lx	Øm
1	537	0,46
2	134	0,92
3	60	1,40
4	34	1,80
5	21	2,30

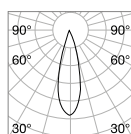

m	lx	Øm
1	2393	0,49
2	598	0,98
3	266	1,50
4	150	2,00
5	96	2,50

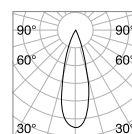

m	lx	Øm
1	2877	0,51
2	719	1,00
3	320	1,50
4	180	2,10
5	115	2,60



CRI≥90 3W 30° 230lm 3000K

CRI≥90 8W 30° 750lm 3000K

CRI≥90 12W 30° 1000lm 3000K

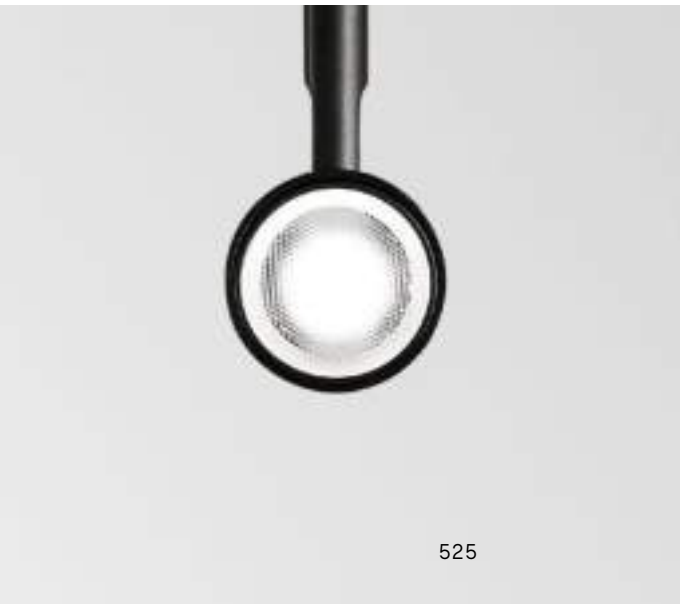

Ego Track Double

LED SMD OSRAM

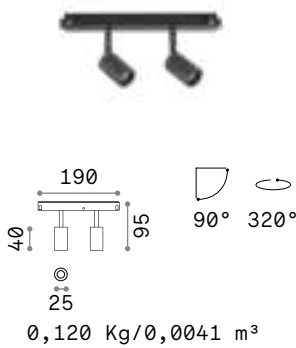

Potenza	Angolo	Lumen	CCT	Controllo	Finitura	Codice	€
5 W	30°	450 lm	3000 K	On-Off	Bianco	282947	115,50 <i>new</i>
					Nero	257624	115,50
					Ottone Sat.	282008	126,50 <i>new</i>
				DALI	Bianco	286341	159,50 <i>new</i>
					Nero	286334	159,50 <i>new</i>

LED COB CITIZEN

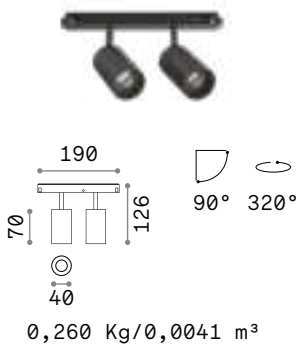

Potenza	Angolo	Lumen	CCT	Controllo	Finitura	Codice	€
16 W	30°	1500 lm	3000 K	On-Off	Bianco	282954	154 <i>new</i>
					Nero	257648	154
					Ottone Sat.	282015	165 <i>new</i>
				DALI	Bianco	286365	198 <i>new</i>
					Nero	286358	198 <i>new</i>

LED COB CITIZEN

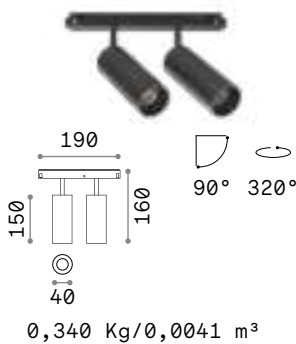

Potenza	Angolo	Lumen	CCT	Controllo	Finitura	Codice	€
24 W	30°	2200 lm	3000 K	On-Off	Bianco	282961	159,50 <i>new</i>
					Nero	257662	159,50
					Ottone Sat.	282022	176 <i>new</i>
				DALI	Bianco	286389	209 <i>new</i>
					Nero	286372	209 <i>new</i>



FILTER HONEYCOMB

Modello	Necessario	Codice	€
Ego 5 W	No	260853	4,40
Ego 16 W	No	260860	4,40
Ego 24 W	No	260860	4,40



Light beam: ACCENT

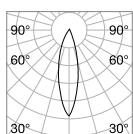

m	lx	Øm
1	508	0,46
2	127	0,92
3	56	1,40
4	32	2,80
5	20	2,30



CRI≥90 5W 30° 450lm 3000K

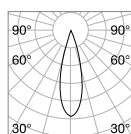

m	lx	Øm
1	2451	0,49
2	613	1,98
3	272	1,50
4	153	2,00
5	98	2,50



CRI≥90 16W 30° 1500lm 3000K

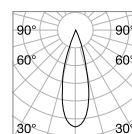

m	lx	Øm
1	3051	0,51
2	763	1,00
3	339	1,50
4	191	2,10
5	122	2,60



CRI≥90 24W 30° 2200lm 3000K



Ego Accent

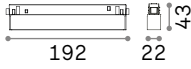

0,140 Kg/0,0013 m³

LED SMD OSRAM UGR <19

Potenza	Angolo	Lumen	CCT	Controllo	Finitura	Codice	€
7 W	35°	750 lm	3000 K	On-Off	Bianco	282633	110 <i>new</i>
					Nero	257792	110
				DALI	Bianco	286068	165 <i>new</i>
					Nero	286051	165 <i>new</i>

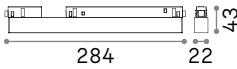

0,210 Kg/0,0019 m³

LED SMD OSRAM UGR <19

Potenza	Angolo	Lumen	CCT	Controllo	Finitura	Codice	€
13 W	35°	1500 lm	3000 K	On-Off	Bianco	282640	145 <i>new</i>
					Nero	257686	145
				DALI	Bianco	286082	159,50 <i>new</i>
					Nero	286075	159,50 <i>new</i>

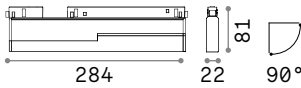

0,470 Kg/0,0031 m³

LED SMD OSRAM UGR <19

Potenza	Angolo	Lumen	CCT	Controllo	Finitura	Codice	€
13 W	35°	1500 lm	3000 K	On-Off	Bianco	282718	192,50 <i>new</i>
					Nero	257846	192,50
				DALI	Bianco	286105	247,50 <i>new</i>
					Nero	286099	247,50 <i>new</i>



Light beam: ACCENT

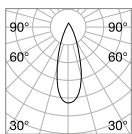

m	lx	Øm
1	3121	0,61
2	780	1,20
3	347	1,80
4	195	2,40
5	125	3,00



CRI≥90 13W 35° 1500lm 3000K



EGO FLEXIBLE ACCENT

Ego Accent 192 mm



Ego Accent 284 mm



Ego Wide

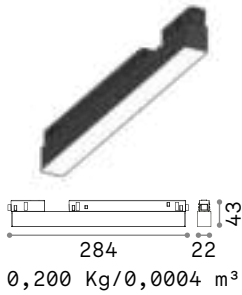

LED SMD SAMSUNG

Potenza	Angolo	Lumen	CCT	Controllo	Finitura	Codice	€
7 W	110°	600 lm	3000 K	On-Off	Bianco	283029	82,50 <i>new</i>
					Nero	257709	82,50
				DALI	Bianco	286501	137,50 <i>new</i>
					Nero	286495	137,50 <i>new</i>

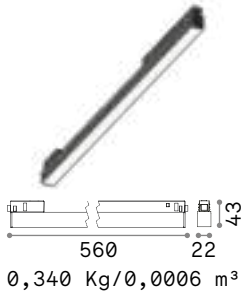

LED SMD SAMSUNG

Potenza	Angolo	Lumen	CCT	Controllo	Finitura	Codice	€
13 W	110°	1200 lm	3000 K	On-Off	Bianco	283036	115,50 <i>new</i>
					Nero	257716	115,50
				DALI	Bianco	286525	165 <i>new</i>
					Nero	286518	165 <i>new</i>

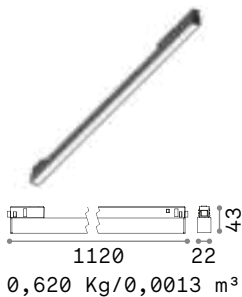

LED SMD SAMSUNG

Potenza	Angolo	Lumen	CCT	Controllo	Finitura	Codice	€
26 W	110°	2400 lm	3000 K	On-Off	Bianco	283043	165 <i>new</i>
					Nero	257730	165
				DALI	Bianco	286549	209 <i>new</i>
					Nero	286532	209 <i>new</i>

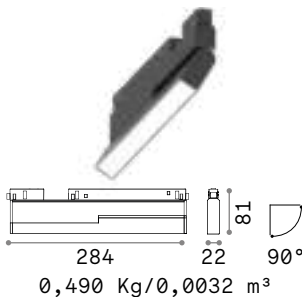

LED SMD SAMSUNG

Potenza	Angolo	Lumen	CCT	Controllo	Finitura	Codice	€
7 W	110°	600 lm	3000 K	On-Off	Bianco	282725	132 <i>new</i>
					Nero	257839	132
				DALI	Bianco	286129	181,50 <i>new</i>
					Nero	286112	181,50 <i>new</i>



Light beam: WIDE

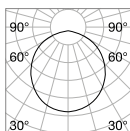

m	lx	Øm
1	619	2,50
2	155	4,90
3	69	7,40
4	39	9,80
5	25	12,00

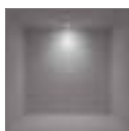

CRI≥90 26W 110° 2400lm 3000K



EGO FLEXIBLE WIDE

Ego Wide 284 mm



Ego Wide 560 mm



Ego Wide 1120 mm



Ego Pendant and Wall Washer

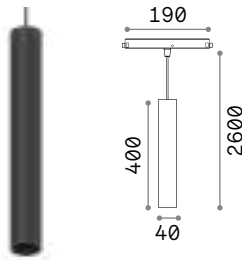

0,540 Kg/0,0038 m³

LED COB CITIZEN UGR <19

Potenza	Angolo	Lumen	CCT	Controllo	Finitura	Codice	€
12 W	30°	1000 lm	3000 K	On-Off	Bianco	282879	159,50 <i>new</i>
					Nero	257747	159,50
				DALI	Bianco	286327	203,50 <i>new</i>
					Nero	286310	203,50 <i>new</i>

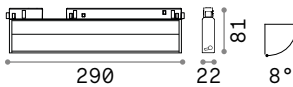

0,320 Kg/0,0026 m³

LED SMD SAMSUNG

Potenza	Angolo	Lumen	CCT	Controllo	Finitura	Codice	€
7 W	-	650 lm	3000 K	On-Off	Bianco	283005	99 <i>new</i>
					Nero	257815	99
				DALI	Bianco	286464	154 <i>new</i>
					Nero	286457	154 <i>new</i>

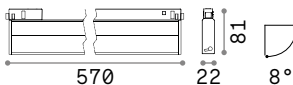

0,560 Kg/0,0012 m³

LED SMD SAMSUNG

Potenza	Angolo	Lumen	CCT	Controllo	Finitura	Codice	€
13 W	-	1300 lm	3000 K	On-Off	Bianco	283012	132 <i>new</i>
					Nero	257822	132
				DALI	Bianco	286488	181,50 <i>new</i>
					Nero	286471	181,50 <i>new</i>



Light beam: ACCENT



Light beam: ASYMMETRICAL

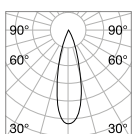

m	lx	Øm
1	2877	0,51
2	719	1,00
3	320	1,50
4	180	2,10
5	115	2,60

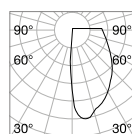

CRI≥90 12W 30° 1000lm 3000K

CRI≥90 13W 1300lm 3000K

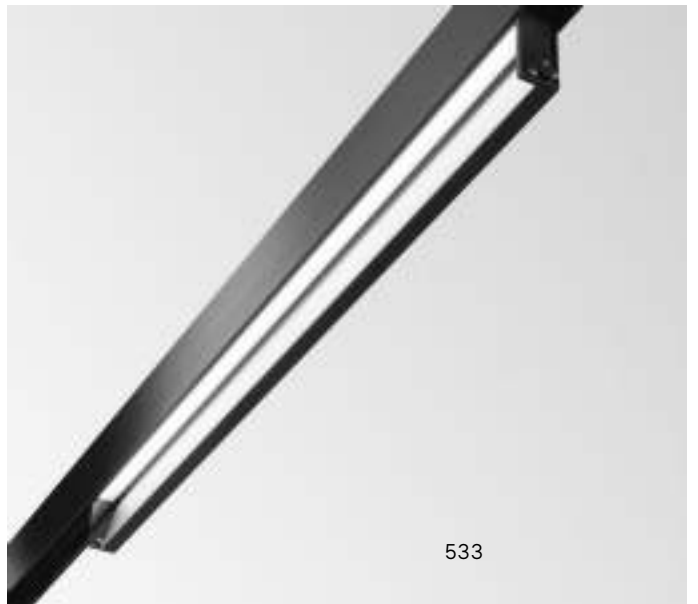

Ego - Suspension Low

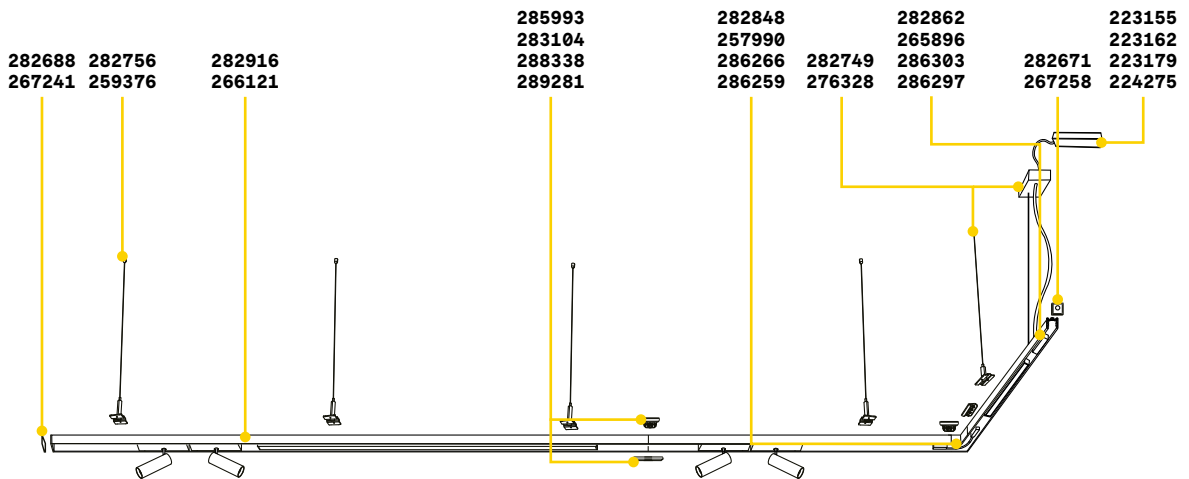

TRACK LOW Lunghezza massima per punto di alimentazione: 25 metri

Lunghezza	Peso	Volume	Finitura	Codice	€
1000 mm	0,68 Kg	0,0013 m ³	Bianco	282909	55 <i>new</i>
			Nero	257877	55
2000 mm	1,36 Kg	0,0026 m ³	Bianco	282916	110 <i>new</i>
			Nero	266121	110

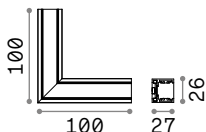

CONNECTOR HORIZONTAL LOW Optional

Peso	Volume	Controllo	Finitura	Codice	€
0,07 Kg	0,0015 m ³	On-Off	Bianco	282848	71,50 <i>new</i>
			Nero	257990	71,50
		DALI	Bianco	286266	82,50 <i>new</i>
			Nero	286259	82,50 <i>new</i>



END CAP NO HOLE

END CAP WITH HOLE

SUSPENSION KIT

KIT SINGLE CABLE

Necessario	Misura (L x H x P)	Finitura	Codice	€
SI	26 x 11 x 27 mm	Bianco	282688	4,40 <i>new</i>
		Nero	267241	4,40
SI	26 x 11 x 27 mm	Bianco	282671	4,40 <i>new</i>
		Nero	267258	4,40
SI - 1 kit x punto di alimentaz. max 210W	2000 mm	Bianco	282749	44 <i>new</i>
		Nero	276328	44
SI - 1 kit x 900 mm	2000 mm	Bianco	282756	13,20 <i>new</i>
		Nero	259376	13,20

Ego - Suspension High

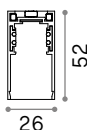
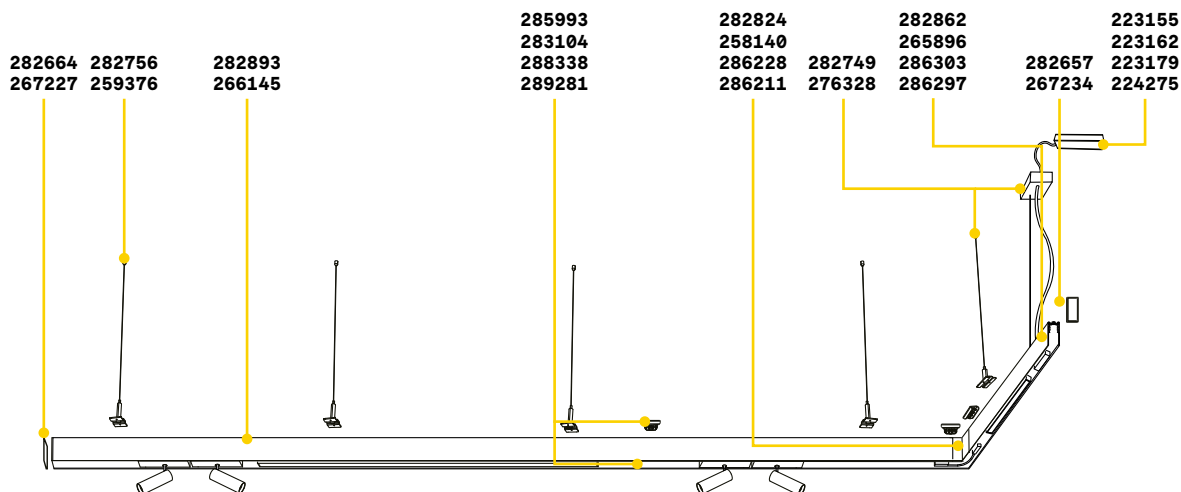

TRACK HIGH Lunghezza massima per punto di alimentazione: 25 metri

Lunghezza	Peso	Volume	Finitura	Codice	€
1000 mm	0,80 Kg	0,0023 m³	Bianco	282886	60,50 <i>new</i>
			Nero	258027	60,50
2000 mm	1,60 Kg	0,0046 m³	Bianco	282893	121 <i>new</i>
			Nero	266145	121

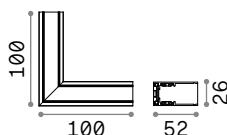

CONNECTOR HORIZONTAL HIGH Optional

Peso	Volume	Controllo	Finitura	Codice	€
0,10 Kg	0,0015 m³	On-Off	Bianco	282824	71,50 <i>new</i>
			Nero	258140	71,50
		DALI	Bianco	286228	82,50 <i>new</i>
			Nero	286211	82,50 <i>new</i>



END CAP NO HOLE

END CAP WITH HOLE

SUSPENSION KIT

KIT SINGLE CABLE

Necessario	Misura (L x H x P)	Finitura	Codice	€
SI	26 x 11 x 52 mm	Bianco	282664	4,40 <i>new</i>
		Nero	267227	4,40
SI	26 x 11 x 52 mm	Bianco	282657	4,40 <i>new</i>
		Nero	267234	4,40
SI - 1 kit x punto di alimentaz. max 210W	2000 mm	Bianco	282749	44 <i>new</i>
		Nero	276328	44
SI - 1 kit x 900 mm	2000 mm	Bianco	282756	13,20 <i>new</i>
		Nero	259376	13,20

Ego - Surface Low

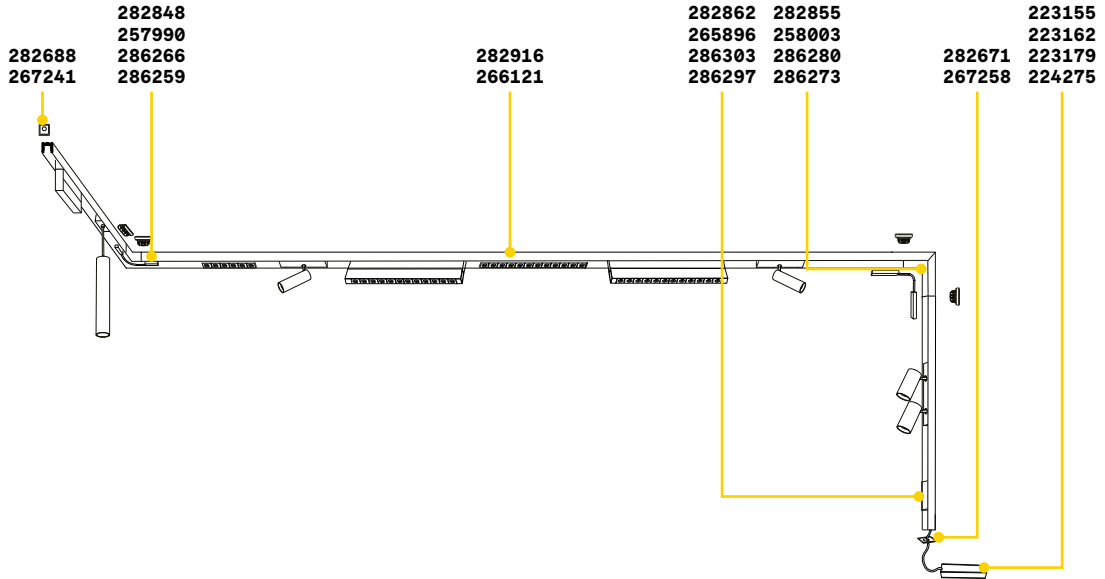

TRACK LOW Kit di montaggio non necessario, fissaggio diretto a soffitto
Lunghezza massima per punto di alimentazione: 25 metri



Lunghezza	Peso	Volume	Finitura	Codice	€
1000 mm	0,68 Kg	0,0013 m ³	Bianco	282909	55 <i>new</i>
			Nero	257877	55
2000 mm	1,36 Kg	0,0026 m ³	Bianco	282916	110 <i>new</i>
			Nero	266121	110

CONNECTOR HORIZONTAL LOW Optional

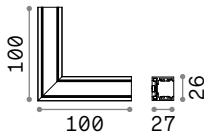

Peso	Volume	Controllo	Finitura	Codice	€
0,07 Kg	0,0015 m ³	On-Off	Bianco	282848	71,50 <i>new</i>
			Nero	257990	71,50
		DALI	Bianco	286266	82,50 <i>new</i>
			Nero	286259	82,50 <i>new</i>

CONNECTOR VERTICAL LOW Optional

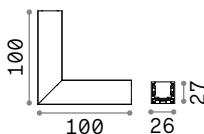

Peso	Volume	Controllo	Finitura	Codice	€
0,07 Kg	0,0015 m ³	On-Off	Bianco	282855	71,50 <i>new</i>
			Nero	258003	71,50
		DALI	Bianco	286280	82,50 <i>new</i>
			Nero	286273	82,50 <i>new</i>



END CAP NO HOLE

END CAP WITH HOLE

Necessario	Misura (L x H x P)	Finitura	Codice	€
SI	26 x 11 x 27 mm	Bianco	282688	4,40 <i>new</i>
		Nero	267241	4,40
SI	26 x 11 x 27 mm	Bianco	282671	4,40 <i>new</i>
		Nero	267258	4,40

Ego - Surface High

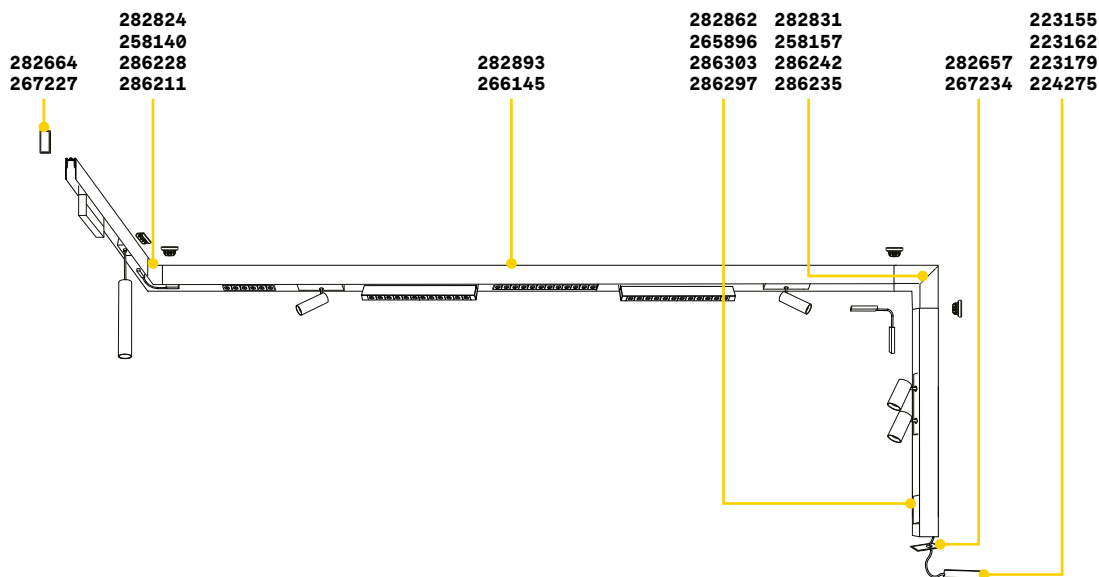

TRACK HIGH Kit di montaggio non necessario, fissaggio diretto a soffitto
Lunghezza massima per punto di alimentazione: 25 metri

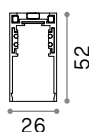

Lunghezza	Peso	Volume	Finitura	Codice	€
1000 mm	0,80 Kg	0,0023 m³	Bianco	282886	60,50 <i>new</i>
			Nero	258027	60,50
2000 mm	1,60 Kg	0,0046 m³	Bianco	282893	121 <i>new</i>
			Nero	266145	121

CONNECTOR HORIZONTAL HIGH Optional

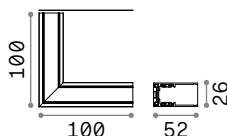

Peso	Volume	Controllo	Finitura	Codice	€
0,10 Kg	0,0015 m³	On-Off	Bianco	282824	71,50 <i>new</i>
			Nero	258140	71,50
		DALI	Bianco	286228	82,50 <i>new</i>
			Nero	286211	82,50 <i>new</i>

CONNECTOR VERTICAL HIGH Optional

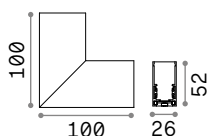

Peso	Volume	Controllo	Finitura	Codice	€
0,10 Kg	0,0015 m³	On-Off	Bianco	282831	71,50 <i>new</i>
			Nero	258157	71,50
		DALI	Bianco	286242	82,50 <i>new</i>
			Nero	286235	82,50 <i>new</i>



END CAP NO HOLE



END CAP WITH HOLE

Necessario	Misura (LxHxP)	Finitura	Codice	€
SI	26 x 11 x 52 mm	Bianco	282664	4,40 <i>new</i>
		Nero	267227	4,40
SI	26 x 11 x 52 mm	Bianco	282657	4,40 <i>new</i>
		Nero	267234	4,40

Ego - Recessed

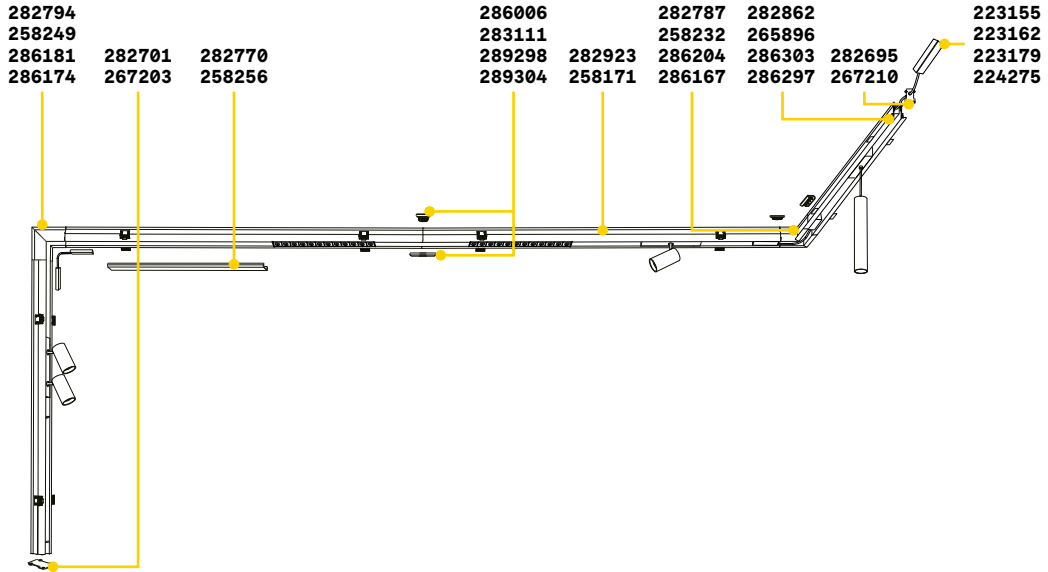

TRACK Kit per montaggio profilo incluso

Lunghezza massima per punto di alimentazione: 25 metri

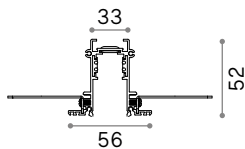

Lunghezza	Peso	Volume	Finitura	Codice	€
1000 mm	1,13 Kg	0,0039 m ³	Bianco	282923	71,50 <i>new</i>
			Nero	258171	71,50
2000 mm	2,26 Kg	0,0078 m ³	Bianco	282930	148,50 <i>new</i>
			Nero	266183	148,50

CONNECTOR HORIZONTAL Optional

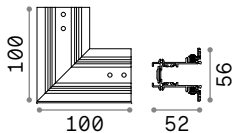

Peso	Volume	Controllo	Finitura	Codice	€
0,13 Kg	0,0015 m ³	On-Off	Bianco	282787	71,50 <i>new</i>
			Nero	258232	71,50
		DALI	Bianco	286204	88 <i>new</i>
			Nero	286167	88 <i>new</i>

CONNECTOR VERTICAL 90° Optional

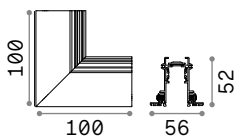

Peso	Volume	Controllo	Finitura	Codice	€
0,10 Kg	0,0015 m ³	On-Off	Bianco	282794	71,50 <i>new</i>
			Nero	258249	71,50
		DALI	Bianco	286181	88 <i>new</i>
			Nero	286174	88 <i>new</i>

CONNECTOR VERTICAL 270° Optional

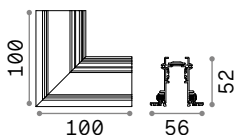

Peso	Volume	Controllo	Finitura	Codice	€
0,14 Kg	0,0015 m ³	On-Off	Bianco	282800	71,50 <i>new</i>
			Nero	259413	71,50
		DALI	Bianco	286150	88 <i>new</i>
			Nero	286198	88 <i>new</i>



BLINDED COVER

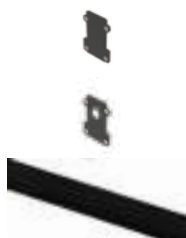

END CAP NO HOLE

END CAP WITH HOLE

BLINDED COVER

Necessario	Misura (L x H x P)	Finitura	Codice	€
SI	36 x 4 x 52 mm	Bianco	282701	4,40 <i>new</i>
		Nero	267203	4,40
SI	36 x 4 x 52 mm	Bianco	282695	4,40 <i>new</i>
		Nero	267210	4,40
No	1000 x 5 x 24 mm	Bianco	282770	13,20 <i>new</i>
		Nero	258256	13,20

Ego - Connectors and drivers

SUSPENSION AND SURFACE LINEAR CONNECTOR

Necessario - 1 Kit x giunzione lineare

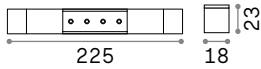

Peso	Volume	Controllo	Finitura	Codice	€
0,16 Kg	0,0005 m ³	On-Off	Bianco	285993	44 <i>new</i>
			Nero	283104	44
		DALI	Bianco	288338	49,50 <i>new</i>
			Nero	289281	49,50 <i>new</i>

RECESSED LINEAR CONNECTOR

Necessario - 1 Kit x giunzione lineare

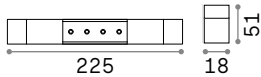

Peso	Volume	Controllo	Finitura	Codice	€
0,16 Kg	0,0005 m ³	On-Off	Bianco	286006	44 <i>new</i>
			Nero	283111	44
		DALI	Bianco	289298	49,50 <i>new</i>
			Nero	289304	49,50 <i>new</i>

MAIN CONNECTOR

Necessario - 1 Kit x unto di alimentaz. max 210W

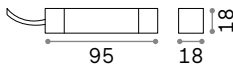

Lunghezza cavo 2000 mm

Peso	Volume	Controllo	Finitura	Codice	€
0,16 Kg	0,0005 m ³	On-Off	Bianco	282862	35,20 <i>new</i>
			Nero	265896	35,20
		DALI	Bianco	286303	40,70 <i>new</i>
			Nero	286297	40,70 <i>new</i>

DRIVER MEANWELL

Necessario



Potenza	Output	Classe	Misura (L x H x P)	Codice	€
60 W	48 Vdc	⊕	171x62x37 mm	223155	132
90 W	48 Vdc	⊕	220x68x37 mm	223162	176
150 W	48 Vdc	⊕	228x68x37 mm	223179	198
240 W	48 Vdc	⊕	244x68x39 mm	224275	220



PROFILE LOW



PROFILE HIGH



Fluo

Sistema lineare di lampade con scocca in alluminio estruso di sezione larga 50 mm e alta 80 mm. Moduli disponibili in due lunghezze: 1200 mm e 1800 mm, componibili tra loro a seconda della disposizione desiderata. Il sistema è disponibile con tre diverse configurazioni: il modello WIDE diffondente, il modello BI-EMISSION con componente luminosa per l'illuminazione indiretta e il modello ACCENT con controllo dell'abbagliamento ($UGR < 13$); LED integrati, possibilità di temperatura di colore di 3000 K o di 4000 K; binning iniziale ≤ 3 -Step MacAdam; protezione IP 20, classe isolamento I; durata utile LED 50.000 h L70B50. Il sistema è disponibile nei colori alluminio anodizzato, bianco, nero e nelle possibili modalità d'installazione singola o in linea continua, per applicazione a plafone, a sospensione oppure a incasso a filo in soffitti di cartongesso. Driver incluso, integrato nel corpo illuminante, disponibile in versione dimmerabile 1-10V, DALI e Push. Sistema adatto per ambienti dove è richiesta un'illuminazione professionale dal design minimale, ad esempio UFFICI e spazi COMMERCIALI.

PRO

Prodotto ad alto contenuto tecnologico, elevata qualità dei materiali, destinato ad uso professionale.

UGR

Articolo con $UGR < 13$ (Accent).

Sorgente	LED COB / SMD
Driver incluso	On/Off
Driver disponibili	1-10V / DALI
MacAdam	SDCM 3
Ottica	Accent/Wide/Bi-Emission
CCT	3000 K / 4000 K
CRI	≥ 83
UGR	< 13 (Accent)
Durata LED	50.000 h
Classe isolamento	I
IP	20
Materiale	Alluminio
Garanzia	5 anni





Fluo Accent

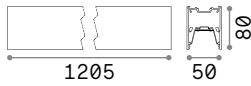

2,760 Kg/0,0183 m³
Lunghezza cavo 1800 mm

LED COB CREE Driver TRIDONIC ON/OFF incluso - UGR <13

Potenza	Angolo	Lumen	CCT	Finitura	Codice	€
30 W	30°	3000 lm	3000 K	Alluminio	192635	341
				Bianco	192611	341
				Nero	192581	341
		3300 lm	4000 K	Alluminio	192574	341
				Bianco	192543	341
				Nero	192529	341

DIMMABLE DRIVER* Optional

	Potenza	Output	Misura (LxHxP)	Codice	€
1-10V	35 W	700 mA	280x30x21 mm	216416	121
DALI/Push	35 W	700 mA	280x30x21 mm	216270	137,50

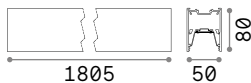

3,860 Kg/0,0269 m³
Lunghezza cavo 1800 mm

LED COB CREE Driver TRIDONIC ON/OFF incluso - UGR <13

Potenza	Angolo	Lumen	CCT	Finitura	Codice	€
30 W	30°	3000 lm	3000 K	Alluminio	192512	418
				Bianco	192499	418
				Nero	192475	418
		3300 lm	4000 K	Alluminio	192451	418
				Bianco	192444	418
				Nero	192420	418

DIMMABLE DRIVER* Optional

	Potenza	Output	Misura (LxHxP)	Codice	€
1-10V	35 W	700 mA	280x30x21 mm	216416	121
DALI/Push	35 W	700 mA	280x30x21 mm	216270	137,50

MOUNTING KIT Necessario - Pagina 551



Light beam: ACCENT

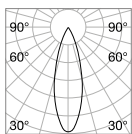

m	Ix	Øm
1	8264	0,48
2	2066	0,96
3	918	1,45
4	516	1,93
5	330	2,42



CRI≥83 30W 30° 3300lm 4000K

* Gli alimentatori dimmerabili devono essere ordinati contestualmente al prodotto e verranno già inclusi all'interno degli apparecchi in sostituzione degli alimentatori on-off. La connessione in linea è disponibile soltanto per le versioni on-off dei prodotti.



Fluo Accent 1200

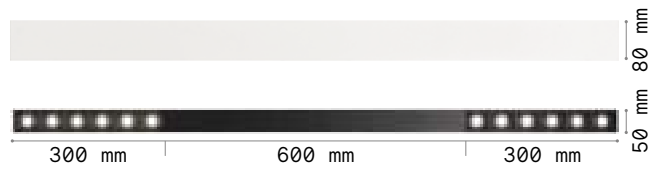

Fluo Accent 1800

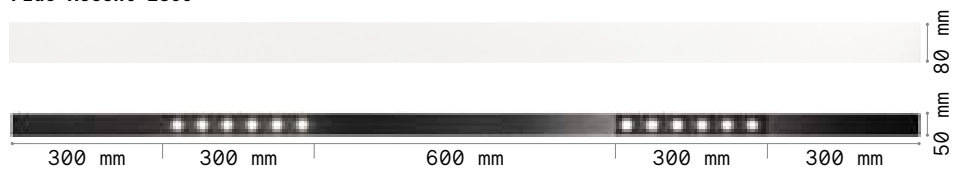

Lo spessore del singolo cappuccio finale è di 2,5 mm.

Fluo Wide

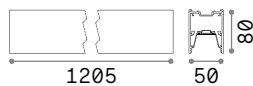

2,890 Kg/0,0183 m³
Lunghezza cavo 1800 mm

LED SMD SAMSUNG Driver TRIDONIC ON/OFF incluso

Potenza	Angolo	Lumen	CCT	Finitura	Codice	€
27 W	105°	3450 lm	3000 K	Alluminio	191447	302,50
				Bianco	192437	302,50
				Nero	191997	302,50
		3650 lm	4000 K	Alluminio	192468	302,50
				Bianco	192482	302,50
				Nero	192505	302,50

DIMMABLE DRIVER* Optional

	Potenza	Output	Misura (LxHxP)	Codice	€
1-10V	35 W	500 mA	280x30x21 mm	216423	121
DALI/Push	35 W	500 mA	280x30x21 mm	216287	137,50



4,420 Kg/0,0269 m³
Lunghezza cavo 1800 mm

LED SMD SAMSUNG Driver TRIDONIC ON/OFF incluso

Potenza	Angolo	Lumen	CCT	Finitura	Codice	€
36 W	105°	4750 lm	3000 K	Alluminio	192536	363
				Bianco	192550	363
				Nero	192567	363
		5050 lm	4000 K	Alluminio	192598	363
				Bianco	192604	363
				Nero	192628	363

DIMMABLE DRIVER* Optional

	Potenza	Output	Misura (LxHxP)	Codice	€
1-10V	35 W	700 mA	280x30x21 mm	216416	121
DALI/Push	35 W	700 mA	280x30x21 mm	216270	137,50

MOUNTING KIT Necessario - Pagina 551



Light beam: WIDE

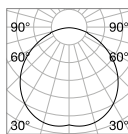

m	lx	Øm
1	1042	2,50
2	260	5,00
3	115	7,50
4	65	10,00
5	41	12,50

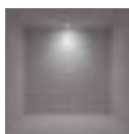

CRI≥83 27W 105° 3650lm 4000K

* Gli alimentatori dimmerabili devono essere ordinati contestualmente al prodotto e verranno già inclusi all'interno degli apparecchi in sostituzione degli alimentatori on-off. La connessione in linea è disponibile soltanto per le versioni on-off dei prodotti.



Fluo Wide 1200

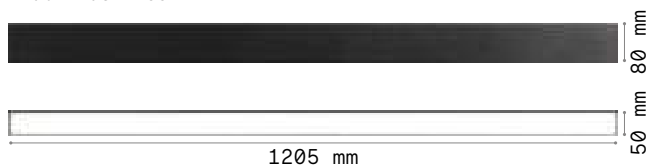

Fluo Wide 1800

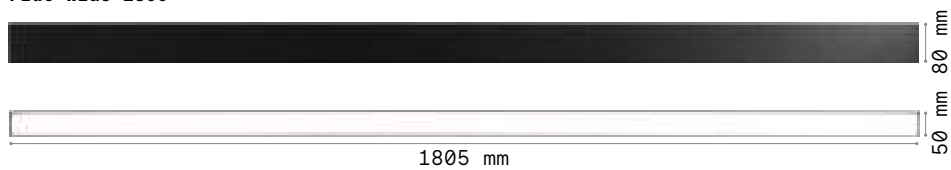

Lo spessore del singolo cappuccio finale è di 2,5 mm.

Fluo Bi-Emission*

LED SMD SAMSUNG

Up-light inclusa - Driver TRIDONIC ON/OFF incluso

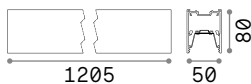

2,890 Kg/0,0183 m³
Lunghezza cavo 1800 mm

Potenza	Angolo	Lumen	CCT	Finitura	Codice	€
27 W	105°	3450 lm	3000 K	Alluminio	192659	412,50
				Bianco	192666	412,50
				Nero	192710	412,50
3650 lm	4000 K	3000 K	Alluminio	192734	412,50	
			Bianco	192741	412,50	
			Nero	192758	412,50	

UP-LIGHT INFO

Potenza	Angolo	Lumen	CCT
13 W	105°	2200 lm	3000 K
		2350 lm	4000 K

KIT DIMMABLE DRIVER*

Codice	€
1-10V	215,50
DALI/Push	253

LED SMD SAMSUNG

Up-light inclusa - Driver TRIDONIC ON/OFF incluso

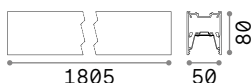

4,420 Kg/0,0269 m³
Lunghezza cavo 1800 mm

Potenza	Angolo	Lumen	CCT	Finitura	Codice	€
36 W	105°	4750 lm	3000 K	Alluminio	192727	544,50
				Bianco	192703	544,50
				Nero	192697	544,50
5050 lm	4000 K	4000 K	Alluminio	192680	544,50	
			Bianco	192673	544,50	
			Nero	192642	544,50	

UP-LIGHT INFO

Potenza	Angolo	Lumen	CCT
18 W	105°	2950 lm	3000 K
		3100 lm	4000 K

KIT DIMMABLE DRIVER*

Codice	€
1-10V	215,50
DALI/Push	253



Light beam: **BI-EMISSION**
WIDE

MOUNTING KIT Necessario - Pagina 551

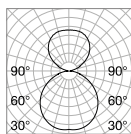

m	lx	Øm
1	512	2,10
2	128	4,21
3	56	6,32
4	32	8,43
5	20	10,54

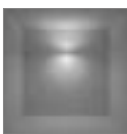

* Accensione separata dell'emissione diretta e indiretta (disponibile solo per versioni on-off). Regolazione in sincronia dell'emissione diretta e indiretta (versioni con dimmerazione 1-10V e Push). Gli alimentatori dimmerabili devono essere ordinati contestualmente al prodotto e verranno già inclusi all'interno degli apparecchi in sostituzione degli alimentatori on-off. La connessione in linea è disponibile soltanto per le versioni on-off dei prodotti.

CRI≥83 27+13W 105°+105° 3650+2350lm 3000K

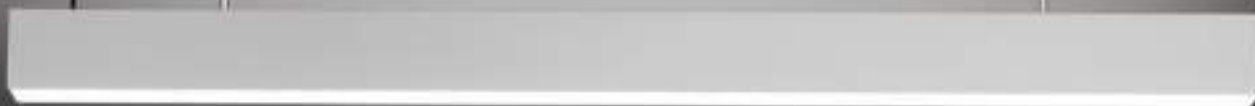

Fluo Bi-Emission 1200



Fluo Bi-Emission 1800



Lo spessore del singolo cappuccio finale è di 2,5 mm.

Fluo - Assembly plans

FLUO SUSPENSION

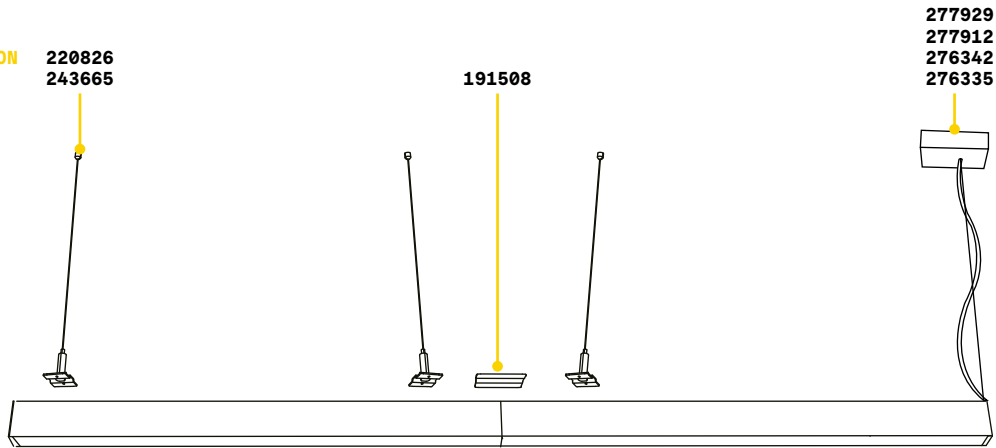



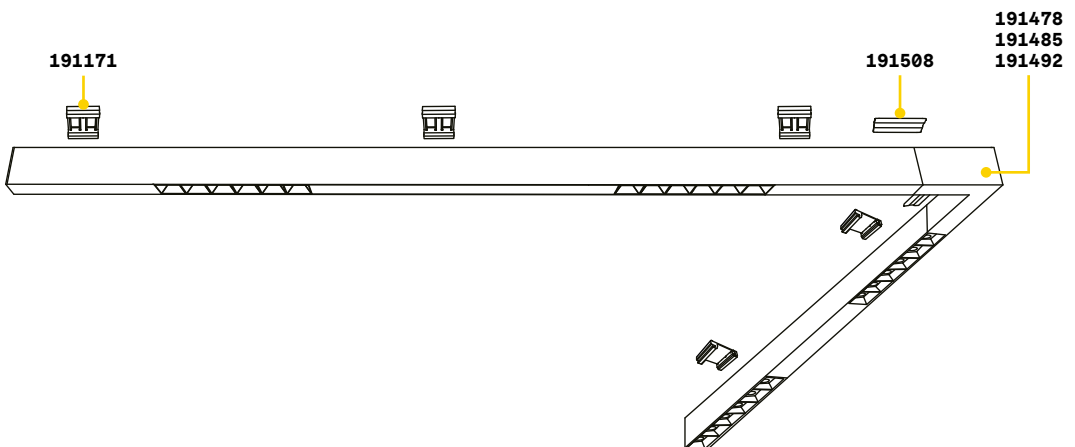

FLUO SURFACE

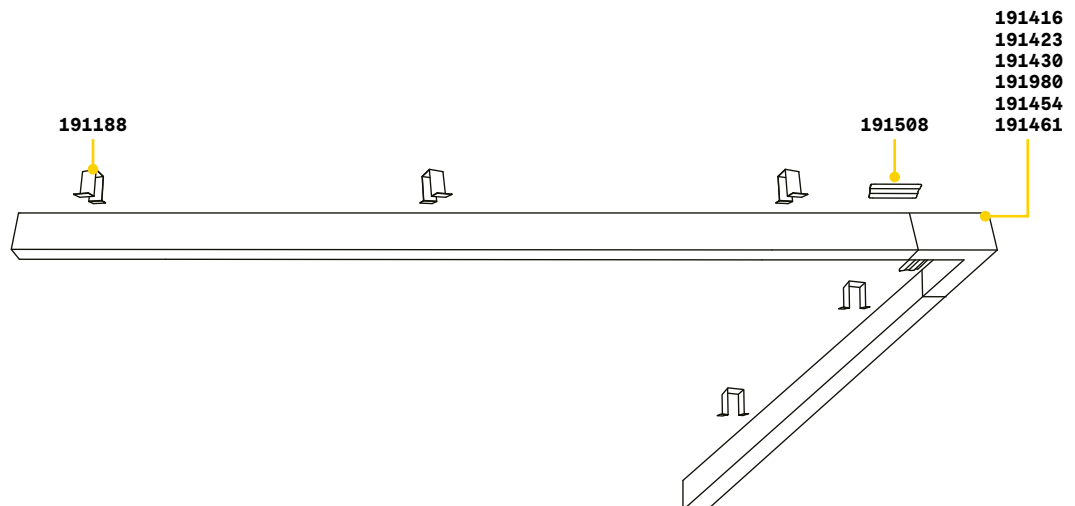

FLUO RECESSED



Fluo - Mounting kit

	Necessario	N° Cavi	Lunghezza cavi	Finitura	Codice	€
	SI - 1 kit x punto di alimentazione	1	2000 mm	Bianco	277929	30,80
				Nero	277912	30,80
		1	5000 mm	Bianco	276342	42,90
				Nero	276335	42,90
	SI - 1 Kit x 600 mm	1	2000 mm		220826	12,10
		1	5000 mm		243665	18,70
	SI - 1 Kit x 600 mm				191188	35,20
	SI - 1 Kit x 600 mm				191171	23,10

Fluo - Optional

CORNER Optional - Driver ON/OFF incluso - Compatibile con versione Wide

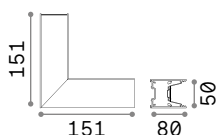

0,580 Kg/0,0023 m³

Potenza	Angolo	Lumen	CCT	Finitura	Codice	€
7,5 W	105°	810 lm	3000 K	Alluminio	191416	93,50
				Bianco	191423	93,50
				Nero	191430	93,50
		850 lm	4000 K	Alluminio	191980	93,50
				Bianco	191454	93,50
				Nero	191461	93,50

BLINDED CORNER Optional - Compatibile con versione Accent

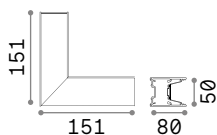

0,610 Kg/0,0023 m³

Finitura	Codice	€
Alluminio	191478	60,50
Bianco	191485	60,50
Nero	191492	60,50

STRUCTURE CONNECTOR Lunghezza max per punto di alimentazione: 30 metri



Necessario	Codice	€
SI - 1 Kit x giunzione	191508	6,60

THICK COVER Compatibile con versione Wide e Bi-Emission



Necessario	Materiale	Lunghezza	Codice	€
No	PMMA	1200 mm	262369	22
		1800 mm	262376	33

Steel

Lampada lineare in alluminio con illuminazione diretta e indiretta con controllo dell'abbagliamento. La componente di luce indiretta può essere accesa o spenta mediante interruttore a bordo dell'apparecchio. La lampada è disponibile nel modello WIDE con ottica downlight diffondente in PMMA microprismatizzato (UGR < 19) e nel modello ACCENT con riflettore nero (UGR < 16). Sorgenti LED integrati; disponibile in CCT 3000 K e 4000 K; CRI ≥ 90; lifetime 50.000 h L70B50; IP20. Adatta per uffici, spazi commerciali e retail.

PRO Prodotto ad alto contenuto tecnologico, elevata qualità dei materiali, destinato ad uso professionale.

UGR Articolo con UGR <16 (Accent), <19 (Wide).

Sorgente	LED SMD
Driver incluso	On/Off
Driver disponibili	No
MacAdam	SDCM 3
Ottica	Accent/Wide
CCT	3000 K / 4000 K
CRI	≥90
UGR	<16 (Accent) / <19 (Wide)
Durata LED	50.000 h
Classe isolamento	I
IP	20
Materiale	Alluminio
Garanzia	5 anni





Steel

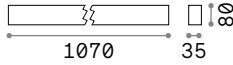

1,990 Kg/0,0178 m³
Lunghezza cavo 1800 mm

LED SMD SAMSUNG

Up-light inclusa - Driver OSRAM ON/OFF incluso - UGR <19

Potenza	Angolo	Lumen	CCT	Finitura	Codice	€
36 W	70°	2600 lm	3000 K	Bianco	267128	280,50
				Nero	270197	280,50
		2770 lm	4000 K	Bianco	270203	280,50
				Nero	267135	280,50

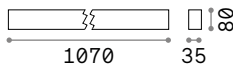

1,980 Kg/0,0178 m³
Lunghezza cavo 1800 mm

LED SMD SAMSUNG

Up-light inclusa - Driver OSRAM ON/OFF incluso - UGR <16

Potenza	Angolo	Lumen	CCT	Finitura	Codice	€
36 W	60°	2500 lm	3000 K	Bianco	270180	324,50
				Nero	267142	324,50
		2680 lm	4000 K	Bianco	267159	324,50
				Nero	270173	324,50

UP-LIGHT INFO

Angolo	Lumen	CCT
110°	1100 lm	3000 K
	1180 lm	4000 K



KIT SUSPENSION

Necessario	N° Cavi	Lunghezza cavi	Finitura	Codice	€
SI - 1 kit x punto di alimentazione	1	2000 mm	Bianco	276311	27,50
			Nero	276304	27,50



KIT SINGLE CABLE

SI - 1 Kit x 500 mm	1	2000 mm		271750	12,10
---------------------	---	---------	--	--------	-------



KIT SURFACE

SI - 1 Kit x 1000 mm				270210	30,80
----------------------	--	--	--	--------	-------



KIT CONTINUOS

SI - 1 Kit x giunzione				271712	6,60
------------------------	--	--	--	--------	------



Light beam: **BI-EMISSION ACCENT**

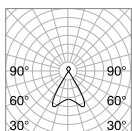

m	lx	dm
1	2216	1,20
2	554	2,40
3	246	3,60
4	139	4,80
5	89	6,10



CRI≥90 36W 70° 2770lm 4000K



Light beam: **BI-EMISSION WIDE**

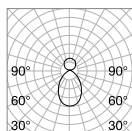

m	lx	dm
1	1173	1,50
2	293	3,10
3	130	4,60
4	73	6,20
5	47	7,70

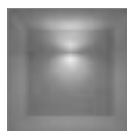

CRI≥90 36W 60° 2680lm 4000K



Steel Accent



80



35

1700

Steel Wide



80



35

1700

Office

Lampada lineare in alluminio con illuminazione diretta per applicazione a sospensione. Disponibile in finitura bianca o nera con riflettori di colore nero. Sorgenti LED integrate con controllo dell'abbagliamento (UGR < 16); disponibile in temperatura di colore 3000 K e 4000 K; CRI ≥ 80; 30.000 h di durata L70B50; protezione IP20, classe isolamento I.

Sorgente	LED SMD	Durata LED	30.000 h
Potenza	30W	Classe	I
Driver incluso	On/Off	isolamento	
Driver disponibili	No	IP	20
CCT	3000 K / 4000 K	Materiale	Alluminio
CRI	≥80		
UGR	<16		

UGR Articolo con UGR <16.

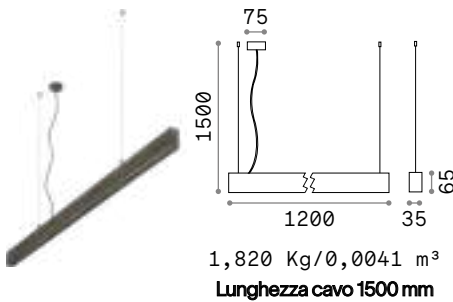

LED SMD Driver ON/OFF incluso

Potenza	Angolo	Lumen	CCT	Finitura	Codice	€
30 W	37°	2800 lm	3000 K	Bianco	271194	181,50
				Nero	271187	181,50
		3100 lm	4000 K	Bianco	271217	181,50
				Nero	271200	181,50



Light beam: ACCENT

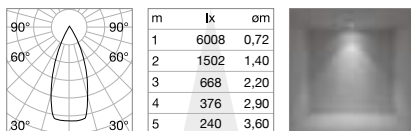

CRI≥80 30W 37° 3100lm 4000K



271194

271187

Tesi

Nastro flessibile in acciaio per applicazione da parete a parete, utilizzato come supporto per applicazione di strip led, diventa una sorgente luminosa per illuminazione indiretta. Ha una lunghezza massima di 5 metri e con la sua sezione minimale scompare all'interno dell'ambiente per garantire un risultato di estrema pulizia formale. Ideale per ambienti dal carattere storico e architettonico già fortemente personalizzati.

STRIP LED SUPPORT

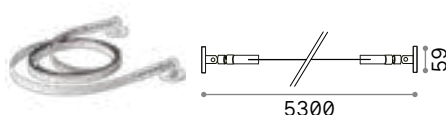

Lunghezza	Peso	Volume	Finitura	Codice	€
5000 mm	0,35 Kg	0,0234 m ³	Acciaio	258300	126,50

STRIP LED AND DRIVER **Necessario - Pagina 814**

RECOMMENDED STRIP LED AND DRIVER

STRIP LED SMD 2835 120 LED/m CRI≥90

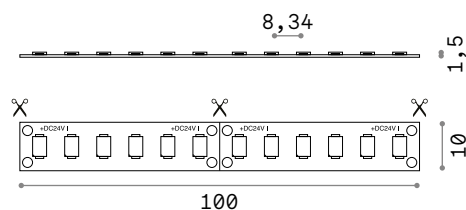

Potenza	IP	Lumen	CCT	Lunghezza	Codice	€
14,4 W/m	IP20	1370 lm/m	2700 K	5000 mm	272498	55,00
		1400 lm/m	3000 K	5000 mm	272481	55,00
		1450 lm/m	4000 K	5000 mm	272474	55,00
IP65	1400 lm/m	3000 K	5000 mm	272504	71,50	
	1450 lm/m	4000 K	5000 mm	287959	71,50	

DRIVER ON/OFF

Driver	Potenza	Output	Classe	Misura (L x H x P)	Codice	€
On-Off	30 W	24 Vdc	□	140x45x28 mm	124070	19,25
	60 W	24 Vdc	□	186x50x33 mm	124087	33,00
	100 W	24 Vdc	⊕	127x97x30 mm	124100	49,50
	150 W	24 Vdc	⊕	159x97x30 mm	124117	55,00
	200 W	24 Vdc	⊕	215x115x30 mm	153001	71,50



Light beam: **INDIRECT**



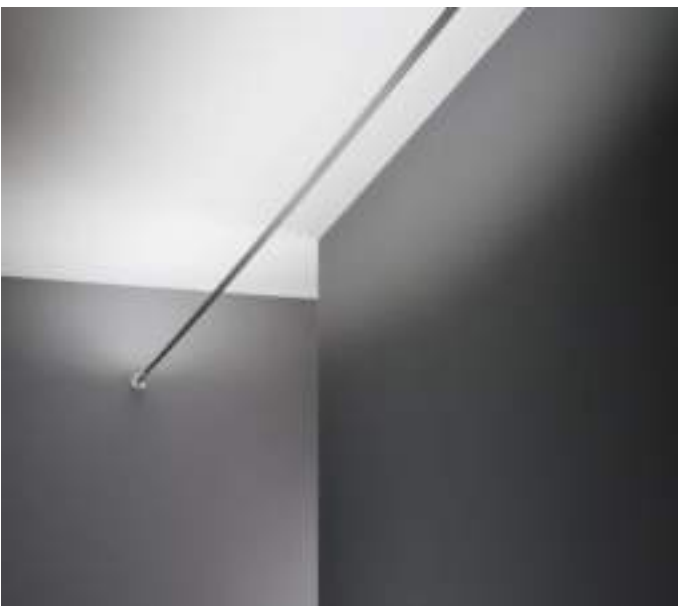

Vision

Profilo in alluminio estruso con superficie anodizzata e verniciata a polveri, disponibile nelle finiture bianco e nero, diffusore in PMMA satinato. Sono disponibili barre in diverse lunghezze nella versione TRIM per installazione a incasso in pannelli o soffitti in cartongesso e nella versione TRIMLESS per installazione a parete e soffitto, disponibile kit per installazione a sospensione. I profili lineari sono disponibili nelle lunghezze di 2000 e 3000 mm, sono componibili a seconda del disegno desiderato e sono sezionabili a misura. Strip LED e driver devono essere abbinati per completare l'installazione: sorgenti luminose di potenza disponibili con temperatura di colore di 3000 K e 4000 K, CRI ≥ 90 e indice protezione IP20. Sistema dotato di ampia flessibilità, adatto per l'illuminazione generale degli ambienti COMMERCIALI e nelle aree vendita nel settore RETAIL.

Versione	Trim / Trimless
Lunghezza	2000 / 3000 mm
Materiale	Alluminio





Vision Trimless

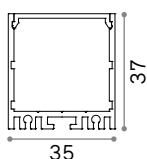

PROFILE Kit per montaggio incluso

Lunghezza	Peso	Volume	Finitura	Codice	€
2000 mm	1,40 Kg	0,0032 m ³	Bianco	270524	60,50
	1,40 Kg	0,0032 m ³	Nero	270517	60,50
3000 mm	2,10 Kg	0,0048 m ³	Bianco	270548	84,70
	2,10 Kg	0,0048 m ³	Nero	270531	84,70



SUSPENSION KIT

Necessario	N° Cavi	Lunghezza cavi	Codice	€
No - 1 Kit x 2000 mm	2	3000 mm	270449	13,20
No - 1 Kit x 2000 mm	2	5000 mm	270456	16,50



STRUCTURE CONNECTOR

SI - 1 Kit x giunzione			270463	4,40
------------------------	--	--	--------	------

STRIP LED AND DRIVER Necessario - Pagina 814

Strip LED consigliata max 39 W/m

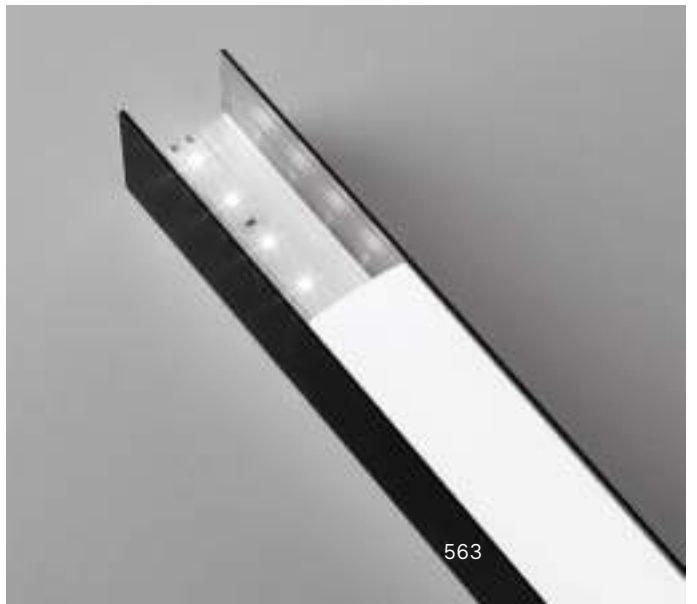

Vision Trim

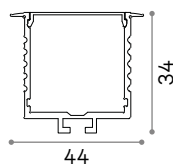

PROFILE Kit per montaggio incluso

Lunghezza	Peso	Volume	Finitura	Codice	€
2000 mm	1,26 Kg	0,0050 m ³	Bianco	270487	60,50
	1,26 Kg	0,0050 m ³	Nero	270470	60,50
3000 mm	1,89 Kg	0,0075 m ³	Bianco	270500	93,50
	1,89 Kg	0,0075 m ³	Nero	270494	93,50



STRUCTURE CONNECTOR

Necessario	Codice	€
SI - 1 Kit x giunzione	271125	4,40

STRIP LED AND DRIVER Necessario - Pagina 814

Strip LED consigliata max 39 W/m



Slot

Profilo in alluminio estruso con superficie anodizzata o verniciata a polveri, disponibile nelle finiture bianco, nero e alluminio, diffusore in PMMA satinato. Sono disponibili barre in diverse sezioni e lunghezze nella versione RECESSED per installazione a incasso in soffitti in cartongesso e nella versione SURFACE per installazione a parete o soffitto. I modelli ANGULAR in versione tonda e quadrata sono concepiti con un angolo interno di inclinazione della sorgente luminosa per l'illuminazione ottimale all'interno di velette e gole luminose. I profili lineari sono disponibili nelle lunghezze di 1000, 2000 e 3000 mm, sono componibili a seconda del disegno desiderato e sono sezionabili a misura. Strip LED e driver devono essere abbinati per completare l'installazione: sorgenti luminose disponibile con temperatura di colore di 2700 K, 3000 K, 4000 K, CRI ≥ 80 , ≥ 85 e ≥ 90 , indice protezione IP20 e IP65.

Versione	Recessed / Surface / Angular
Larghezza	12 / 14 / 15 / 16 / 20 / 31 mm
Materiale	Alluminio





Slot Recessed

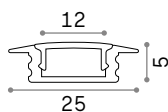

PROFILE 12 mm Kit per montaggio incluso

Lunghezza	Peso	Volume	Finitura	Codice	€
1000 mm	0,15 Kg	0,0010 m ³	Bianco	124155	14,30
2000 mm	0,35 Kg	0,0020 m ³	Bianco	203102	24,20
3000 mm	0,54 Kg	0,0030 m ³	Bianco	204611	36,30

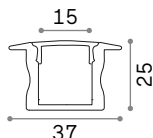

PROFILE 15 mm Kit per montaggio incluso

Lunghezza	Peso	Volume	Finitura	Codice	€
2000 mm	0,48 Kg	0,0020 m ³	Bianco	267265	27,50
	0,48 Kg	0,0020 m ³	Nero	267289	27,50
3000 mm	0,72 Kg	0,0029 m ³	Bianco	267272	38,50
	0,72 Kg	0,0029 m ³	Nero	267296	38,50

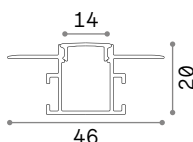

PROFILE 14 mm

Lunghezza	Peso	Volume	Finitura	Codice	€
2000 mm	0,65 Kg	0,0020 m ³	Bianco	223704	56,10
3000 mm	0,90 Kg	0,0029 m ³	Bianco	223711	89,10

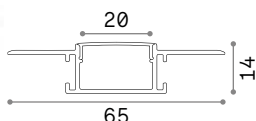

PROFILE 20 mm

Lunghezza	Peso	Volume	Finitura	Codice	€
2000 mm	0,60 Kg	0,0020 m ³	Bianco	223728	66
3000 mm	0,90 Kg	0,0029 m ³	Bianco	223735	96,80

KIT PROFILE 14 / 20 mm



KIT LINEAR

KIT RIGHT-LEFT

KIT VERTICAL-HORIZONTAL

Necessario	Codice	€
SI - 1Kit x giunzione	223766	5,50
SI - 1Kit x giunzione	223759	5,50
SI - 1Kit x giunzione	223742	5,50

STRIP LED AND DRIVER Necessario - Pagina 814

Strip LED consigliata max 14,4 W/m



223728
223735

223704
223711



Kit per montaggio PROFILE 12 mm.



223728
223735

Slot Surface

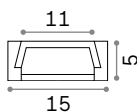

PROFILE 15 mm Kit per montaggio incluso

Lunghezza	Peso	Volume	Finitura		Codice	€
1000 mm	0,15 Kg	0,0010 m ³	Bianco		124131	11
	0,15 Kg	0,0010 m ³	Alluminio		124124	11
2000 mm	0,20 Kg	0,0020 m ³	Bianco		203089	19,80
	0,20 Kg	0,0020 m ³	Alluminio		203072	19,80
3000 mm	0,34 Kg	0,0030 m ³	Bianco		204598	28,60
	0,34 Kg	0,0030 m ³	Alluminio		204581	28,60

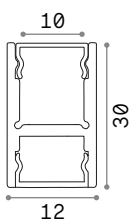

PROFILE 12 mm Kit per montaggio incluso

Lunghezza	Peso	Volume	Finitura		Codice	€
1000 mm	0,44 Kg	0,0010 m ³	Bianco		267326	22
	0,44 Kg	0,0010 m ³	Alluminio		267302	22
	0,44 Kg	0,0010 m ³	Nero		267319	22
2000 mm	0,88 Kg	0,0020 m ³	Bianco		267357	33
	0,88 Kg	0,0020 m ³	Alluminio		267333	33
	0,88 Kg	0,0020 m ³	Nero		267340	33
3000 mm	1,32 Kg	0,0029 m ³	Bianco		267388	55
	1,32 Kg	0,0029 m ³	Alluminio		267364	55
	1,32 Kg	0,0029 m ³	Nero		267371	55

STRIP LED AND DRIVER **Necessario - Pagina 814**

Strip LED consigliata max 14,4 W/m



Kit per montaggio PROFILE 15 mm.



Slot Angular

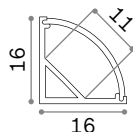

ROUND 16x16

Lunghezza	Peso	Volume	Finitura	Codice	€
1000 mm	0,15 Kg	0,0010 m ³	Bianco	126548	13,20
	0,15 Kg	0,0010 m ³	Alluminio	126531	13,20
2000 mm	0,30 Kg	0,0020 m ³	Bianco	203126	24,20
	0,30 Kg	0,0020 m ³	Alluminio	203119	24,20
3000 mm	0,44 Kg	0,0030 m ³	Bianco	204635	36,30
	0,44 Kg	0,0030 m ³	Alluminio	204628	36,30

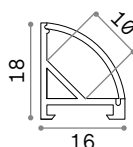

ROUND 16x18

Lunghezza	Peso	Volume	Finitura	Codice	€
2000 mm	0,30 Kg	0,0020 m ³	Bianco	267401	20,90
	0,30 Kg	0,0020 m ³	Alluminio	267395	20,90
3000 mm	0,45 Kg	0,0029 m ³	Bianco	267425	33
	0,45 Kg	0,0029 m ³	Alluminio	267418	33

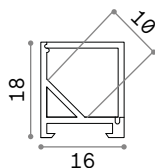

SQUARE 16x18

Lunghezza	Peso	Volume	Finitura	Codice	€
2000 mm	0,30 Kg	0,0020 m ³	Bianco	267449	20,90
	0,30 Kg	0,0020 m ³	Alluminio	267432	20,90
3000 mm	0,45 Kg	0,0029 m ³	Bianco	267463	33
	0,45 Kg	0,0029 m ³	Alluminio	267456	33

STRIP LED AND DRIVER Necessario - Pagina 814

Strip LED consigliata max 14,4 W/m

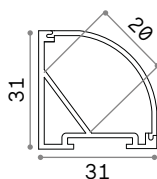

ROUND 31x31

Lunghezza	Peso	Volume	Finitura	Codice	€
2000 mm	0,70 Kg	0,0020 m ³	Bianco	267722	27,50
	0,70 Kg	0,0020 m ³	Alluminio	267715	27,50
3000 mm	1,05 Kg	0,0029 m ³	Bianco	267746	38,50
	1,05 Kg	0,0029 m ³	Alluminio	267739	38,50

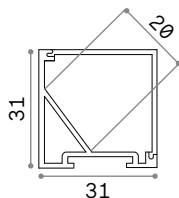

SQUARE 31x31

Lunghezza	Peso	Volume	Finitura	Codice	€
2000 mm	0,70 Kg	0,0020 m ³	Bianco	267487	27,50
	0,70 Kg	0,0020 m ³	Alluminio	267470	27,50
3000 mm	1,05 Kg	0,0029 m ³	Bianco	267500	38,50
	1,05 Kg	0,0029 m ³	Alluminio	267494	38,50

STRIP LED AND DRIVER Necessario - Pagina 814

Strip LED consigliata max 19,2 W/m

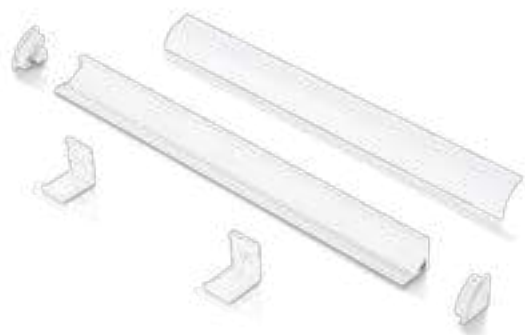

Kit per montaggio PROFILE 16x16 mm.





Interni













Proiettori e binari



Indice alfabetico

Display	604
Eos	600
Fox	592
Glim	603
Link	612
Look	603
Mouse	602
Quick	576
Smile	584
Spot	602

Indice icone

		 <small>new</small>
Quick 576	Smile 584	Fox 592
 <small>new</small>	 <small>new</small>	 <small>new</small>
Eos 600	Mouse 602	Spot 602
		
Glim 603	Look 603	
 <small>new</small>	 <small>new</small>	 <small>new</small>
Display Accent 606	Display Wide 608	Display UGR 610
		
Link 612		

Quick

Proiettore cilindrico in alluminio estruso adatto per installazione su binario trifase. Verniciatura a polveri bianco o nero, testata girevole 355° e orientabile 90°. Il driver di alimentazione incluso, trova alloggiamento nel corpo cilindrico del proiettore stesso. Disponibile anche in versione dimmerabile 1-10 V o DALI. Sorgente luminosa con tecnologia COB LED integrato per la massima efficienza, disponibile con temperatura di colore di 3000 K o 4000 K; LED efficienza energetica elevata resa cromatica fino a CRI ≥90; binning iniziale ≤3-Step MacAdam; ottica a fascio simmetrico con tre diversi angoli di emissione e controllo dell'abbagliamento (UGR <19). Montaggio e smontaggio senza utensili. Protezione IP20; classe isolamento I; durata utile LED 50.000 h L80B50. Ideale per l'illuminazione di grandi ambienti dove viene richiesta ampia flessibilità e resa cromatica, ad esempio spazi MUSEALI, COMMERCIALI e RETAIL.

PRO

Prodotto ad alto contenuto tecnologico, elevata qualità dei materiali, destinato ad uso professionale.

Sorgente	LED COB
Potenza	15W / 21W / 28W
Driver incluso	On/Off / 1-10V / DALI
Driver disponibili	No
Binario	Trifase (standard Eutrac)
MacAdam	SDCM 3
CCT	3000 K / 4000 K
CRI	≥80 / ≥90
Durata LED	50.000h
Classe isolamento	I
IP	20
Materiale	Alluminio
Garanzia	5 anni



[Link - Pagina 612](#)



Quick 15W

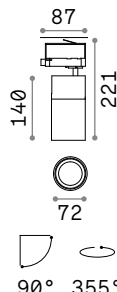

0,760 Kg/0,0038 m³

LED COB CITIZEN

CRI ≥ 80

Potenza	Angolo	Driver	Lumen	CCT	Finitura	Codice	€
15W	30°	On-Off	1900 lm	3000 K	Bianco	222509	143
					Nero	222523	143
		1-10V	1900 lm	3000 K	Bianco	249643	198
					Nero	247861	198
		DALI	1900 lm	3000 K	Bianco	249681	231
					Nero	246437	231

CRI ≥ 90

Potenza	Angolo	Driver	Lumen	CCT	Finitura	Codice	€
15W	30°	On-Off	1650 lm	3000 K	Bianco	222554	143
					Nero	222561	143
			1800 lm	4000 K	Bianco	222578	143
					Nero	222585	143



FILTER HONEYCOMB



LENS*



SINGLE CONNECTION

Necessario	Angolo	Driver	Finitura	Codice	€
No			Nero	222608	8,80
No	15°		Trasparen.	222592	8,80
No	45°		Trasparen.	253558	8,80
No		On/Off	Bianco	170145	26,40
			Nero	170152	26,40
		DALI/1-10V	Bianco	247649	28,60
			Nero	247632	28,60



Light beam: ACCENT

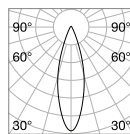

m	lx	Øm
1	3451	0,51
2	862	1,02
3	383	1,53
4	215	2,04
5	138	2,55



CRI ≥ 80 15W 30° 1900lm 3000K

* La lente deve essere ordinata contestualmente al prodotto e verrà montata nel prodotto al posto della lente standard inclusa.

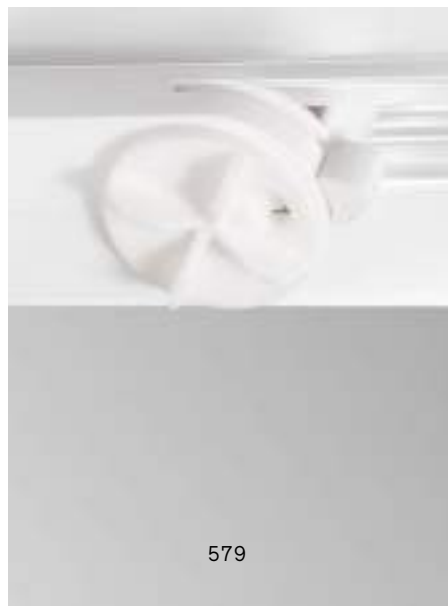

Quick 21W

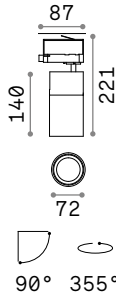

0,760 Kg/0,0038 m³

LED COB CITIZEN

CRI ≥ 80

Potenza	Angolo	Driver	Lumen	CCT	Finitura	Codice	€
21W	30°	On-Off	2650 lm	3000 K	Bianco	247946	148,50
					Nero	247939	148,50
		1-10V	2650 lm	3000 K	Bianco	247960	148,50
					Nero	247953	148,50
		DALI	2650 lm	3000 K	Bianco	249650	214,50
					Nero	247878	214,50
				Bianco	249698	247,50	
				Nero	246444	247,50	

CRI ≥ 90

Potenza	Angolo	Driver	Lumen	CCT	Finitura	Codice	€
21W	30°	On-Off	2350 lm	3000 K	Bianco	247977	148,50
					Nero	225364	148,50
			2550 lm	4000 K	Bianco	247991	148,50
					Nero	247984	148,50



FILTER HONEYCOMB



LENS*



SINGLE CONNECTION

Necessario	Angolo	Driver	Finitura	Codice	€
No			Nero	222608	8,80
No	15°		Trasparen.	222592	8,80
No	45°		Trasparen.	253558	8,80
No		On/Off	Bianco	170145	26,40
			Nero	170152	26,40
		DALI/1-10V	Bianco	247649	28,60
			Nero	247632	28,60



Light beam: ACCENT

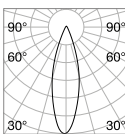

m	lx	Øm
1	6576	0,57
2	1644	1,14
3	731	1,71
4	411	2,28
5	263	2,85



CRI ≥ 80 21W 30° 2650lm 3000K

* La lente deve essere ordinata contestualmente al prodotto e verrà montata nel prodotto al posto della lente standard inclusa.

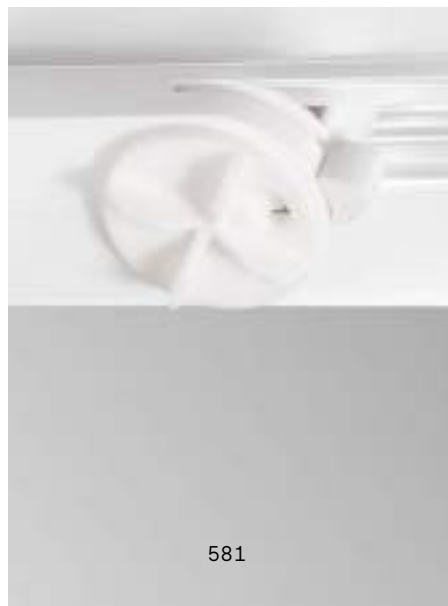

Quick 28W

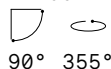
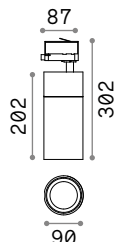

1,200 Kg/0,0063 m³

LED COB CITIZEN

CRI ≥ 80

Potenza	Angolo	Driver	Lumen	CCT	Finitura	Codice	€	
28 W	30°	On-Off	3850 lm	3000 K	Bianco	222615	176	
					Nero	222622	176	
		1-10V	3850 lm	3000 K	Bianco	249674	236,50	
					Nero	247885	236,50	
			DALI	3850 lm	3000 K	Bianco	249704	291,50
						Nero	246413	291,50

CRI ≥ 90

Potenza	Angolo	Driver	Lumen	CCT	Finitura	Codice	€
28 W	30°	On-Off	3400 lm	3000 K	Bianco	222653	176
					Nero	222660	176
			3600 lm	4000 K	Bianco	222677	176
					Nero	222684	176



FILTER HONEYCOMB



LENS*



SINGLE CONNECTION

Necessario	Angolo	Driver	Finitura	Codice	€
No			Nero	222714	9,90
No	18°		Trasparen.	222691	9,90
No	45°		Trasparen.	222707	9,90
No		On/Off	Bianco	170145	26,40
			Nero	170152	26,40
		DALI/1-10V	Bianco	247649	28,60
			Nero	247632	28,60



Light beam: ACCENT

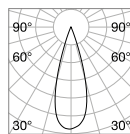

m	lx	Øm
1	8760	0,55
2	2190	1,11
3	973	1,67
4	547	2,22
5	350	2,78



CRI ≥ 80 28 W 30° 3850 lm 3000 K

* La lente deve essere ordinata contestualmente al prodotto e verrà montata nel prodotto al posto della lente standard inclusa.

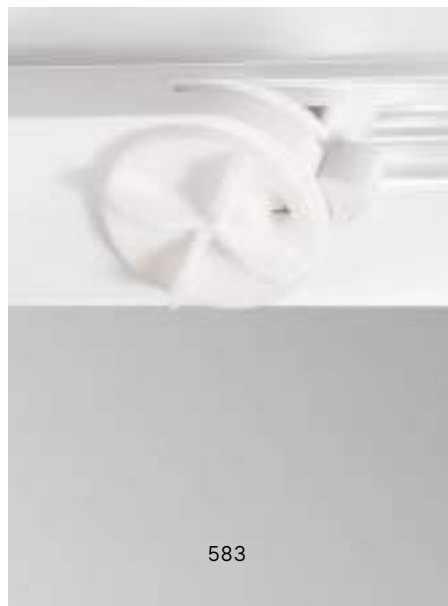

Smile

Proiettore cilindrico in alluminio (estrusione + lavorazione CNC + forgiatura) adatto per installazione su binario trifase.

Verniciatura a polveri in bianco o nero, testata girevole 350° e orient. 90°; il driver di alimentazione è incluso e trova alloggiamento nel corpo cilindrico del proiettore stesso.

Sorgente luminosa con tecnologia COB LED integrato, disponibile con una temperatura di colore di 3000 K o 4000K e con indice di resa cromatica fino a 90; binning iniziale ≤ 4 -Step MacAdam; ottica a fascio simmetrico con tre diversi angoli di emissione e controllo dell'abbagliamento (UGR <19). Montaggio e smontaggio senza utensili. Protezione IP20; classe isolamento II; durata utile LED 50.000 h L70B50. Ideale per l'illuminazione di grandi ambienti dove viene richiesta ampia flessibilità e resa cromatica, ad esempio spazi MUSEALI, COMMERCIALI e RETAIL.



Articolo con UGR <19.

Sorgente	LED COB
Potenza	15W / 20W / 30W
Driver incluso	On/Off
Driver disponibili	No
Binario	Trifase (standard Eutrac)
MacAdam	SDCM ≤ 4
CCT	3000 K / 4000 K
CRI	$\geq 82 / \geq 92$
Durata LED	50.000h
Classe isolamento	II
IP	20
Materiale	Alluminio
Garanzia	5 anni



[Link - Pagina 612](#)





Smile 15W

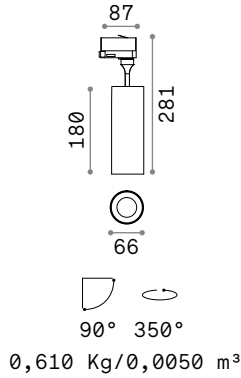

LED COB PHILIPS Driver TRIDONIC ON/OFF incluso

CRI ≥ 82

Potenza	Angolo	Lumen	CCT	Finitura	Codice	€	
15W	24°	1600 lm	3000 K	Bianco	189574	115	
				Nero	189581	115	
		1700 lm	4000 K	Bianco	189611	115	
				Nero	189628	115	
		36°	1600 lm	3000 K	Bianco	189758	115
					Nero	189765	115
	1700 lm		4000 K	Bianco	189796	115	
				Nero	189802	115	
	50°		1600 lm	3000 K	Bianco	189932	115
					Nero	189949	115
	1700 lm	4000 K	Bianco	189956	115		
			Nero	189963	115		

CRI ≥ 92

Potenza	Angolo	Lumen	CCT	Finitura	Codice	€	
15W	24°	1200 lm	3000 K	Bianco	189598	115	
				Nero	189604	115	
		36°	1200 lm	3000 K	Bianco	189772	115
					Nero	189789	115
	50°	1200 lm	3000 K	Bianco	189970	115	
				Nero	189987	115	



FILTER HONEYCOMB

FILTER ELLIPTICAL

RING

SINGLE CONNECTION

Necessario	Driver	Finitura	Codice	€
No		Nero	189536	5,50
No		Trasparen.	189543	7,70
No		Bianco	189505	14,30
No	On/Off	Bianco	170145	26,40
		Nero	170152	26,40



Light beam: SPOT

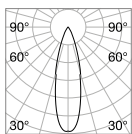

m	lx	Øm
1	4362	0,47
2	1090	0,94
3	484	1,41
4	272	1,88
5	174	2,35

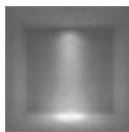

CRI ≥ 82 15W 24° 1600lm 3000K



Light beam: ACCENT

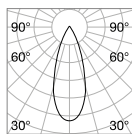

m	lx	Øm
1	2923	0,64
2	730	1,29
3	324	1,94
4	182	2,58
5	116	3,23



CRI ≥ 82 15W 36° 1600lm 3000K



Light beam: WIDE

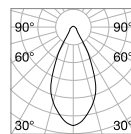

m	lx	Øm
1	1611	0,89
2	402	1,79
3	179	2,69
4	100	3,59
5	64	4,49

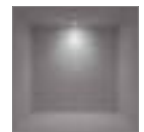

CRI ≥ 82 15W 50° 1600lm 3000K



Smile 20W

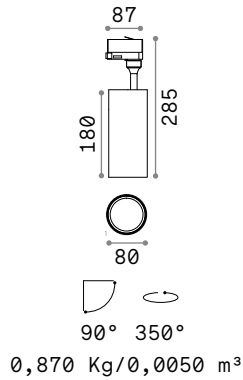

LED COB PHILIPS Driver TRIDONIC ON/OFF incluso

CRI ≥ 82

Potenza	Angolo	Lumen	CCT	Finitura	Codice	€
20W	24°	2350 lm	3000 K	Bianco	189635	132
				Nero	189642	132
		2500 lm	4000 K	Bianco	189673	132
				Nero	189680	132
	36°	2350 lm	3000 K	Bianco	189819	132
				Nero	189826	132
		2500 lm	4000 K	Bianco	189857	132
				Nero	189864	132
	50°	2350 lm	3000 K	Bianco	189994	132
				Nero	190006	132
		2500 lm	4000 K	Bianco	190013	132
				Nero	190020	132

CRI ≥ 92

Potenza	Angolo	Lumen	CCT	Finitura	Codice	€
20W	24°	2200 lm	3000 K	Bianco	189659	132
				Nero	189666	132
	36°	2200 lm	3000 K	Bianco	189833	132
				Nero	189840	132
	50°	2200 lm	3000 K	Bianco	190037	132
				Nero	190044	132



FILTER HONEYCOMB

FILTER ELLIPTICAL

RING

SINGLE CONNECTION

Necessario	Driver	Finitura	Codice	€
No		Nero	190181	5,50
No		Trasparen.	190259	8,80
No		Bianco	189529	12,10
No	On/Off	Bianco	170145	26,40
		Nero	170152	26,40



Light beam: SPOT



Light beam: ACCENT



Light beam: WIDE

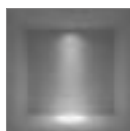
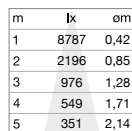
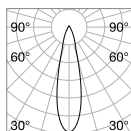

CRI ≥ 82 20W 24° 2350lm 3000K

CRI ≥ 82 20W 36° 2350lm 3000K

CRI ≥ 82 20W 50° 2350lm 3000K



Smile 30W

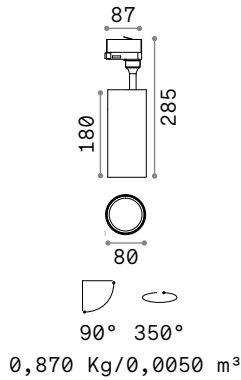

LED COB PHILIPS Driver TRIDONIC ON/OFF incluso

CRI ≥ 82

Potenza	Angolo	Lumen	CCT	Finitura	Codice	€
30W	24°	3150 lm	3000 K	Bianco	189697	143
				Nero	189703	143
		3400 lm	4000 K	Bianco	189734	143
				Nero	189741	143
	36°	3150 lm	3000 K	Bianco	189871	143
				Nero	189888	143
		3400 lm	4000 K	Bianco	189895	143
				Nero	189901	143
	50°	3150 lm	3000 K	Bianco	190051	143
				Nero	190068	143
		3400 lm	4000 K	Bianco	190075	143
				Nero	190082	143

CRI ≥ 92

Potenza	Angolo	Lumen	CCT	Finitura	Codice	€
30W	24°	2900 lm	3000 K	Bianco	189710	143
				Nero	189727	143
	36°	2900 lm	3000 K	Bianco	189918	143
				Nero	189925	143
	50°	2900 lm	3000 K	Bianco	190099	143
				Nero	190105	143



FILTER HONEYCOMB

FILTER ELLIPTICAL

RING

SINGLE CONNECTION

Necessario	Driver	Finitura	Codice	€
No		Nero	190181	5,50
No		Trasparen.	190259	8,80
No		Bianco	189529	12,10
No	On/Off	Bianco	170145	26,40
		Nero	170152	26,40



Light beam: SPOT

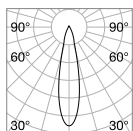

m	lx	cm
1	12955	0,39
2	3238	0,79
3	1439	1,19
4	809	1,59
5	518	1,99



CRI ≥ 82 30W 24° 3150lm 3000K



Light beam: ACCENT

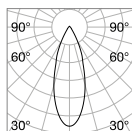

m	lx	cm
1	6240	0,62
2	1560	1,24
3	693	1,86
4	390	2,48
5	249	3,10



CRI ≥ 82 30W 36° 3150lm 3000K



Light beam: WIDE

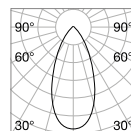

m	lx	cm
1	3740	0,88
2	935	1,76
3	415	2,65
4	233	3,53
5	149	4,42



CRI ≥ 82 30W 50° 3150lm 3000K



Fox new

Proiettore cilindrico in alluminio estruso, adatto per installazione su binario trifase. Verniciatura a polveri in bianco o nero, testata girevole 275° e orientabile fino a 90°; il driver di alimentazione è incluso e trova alloggiamento nel corpo cilindrico del proiettore stesso. Sorgente luminosa con tecnologia COB LED integrato, disponibile in tre diverse potenze con una temperatura di colore di 3000 K o 4000K e con indice di resa cromatica fino a 90; binning iniziale ≤2-Step MacAdam; ottica simmetrica a fascio di apertura medio. Montaggio e smontaggio senza utensili. Protezione IP20; classe isolamento I; durata utile LED 30.000 h L70B50. Ideale per l'illuminazione di piccoli e medi ambienti dove vengono richiesti ampia flessibilità di disposizione, ad esempio in spazi COMMERCIALI e RETAIL, e un rapporto ottimale tra prestazioni e prezzo.

Sorgente	LED COB
Potenza	8W / 15W / 25W
Driver incluso	On/Off
Driver disponibili	No
Binario	Trifase (standard Eutrac)
MacAdam	SDCM3
CCT	3000 K / 4000 K
CRI	≥80 / ≥90
Durata LED	30.000 h
Classe isolamento	I
IP	20
Materiale	Alluminio
Garanzia	5 anni



[Link - Pagina 612](#)





Hot Drinks

Espresso	1.50	2.00
Espresso macchiato	1.00	2.30
Americano	1.00	
Cappuccino	2.10	
Caffè latte	2.20	
Flat White	2.00	
Chai Latte	2.00	
Hot Chocolate	2.20	
Hot milk w. Honey	2.00	

Cold Drinks

Miscel. Water	0.33l	2.00
Afri Cola	0.2 l	2.00
Sweet Single Lemon	0.33l	2.40
— cherry, pear, orange		
Hawaiian Lemonade	0.33l	3.00
Juice	0.2 l	2.00
— apple, mandarin		
Juice w. sparkling water	0.33l	2.80

Limonade	0.33l	2.10
Club Mate	0.33l	2.20

Homemade Gingerbeer (no alcohol)	0.33l	3.00
----------------------------------	-------	------

Acid-Orange-Zucker, Honey-lemon-
Caramell, Sticky Toffee, Vanilla-
Tiramisu, Avokado Buns, Black-
Cherry-Berry, Apple-Ginger, Chai
Bergamot
Fresh Tea 2.50
Ginger, Mint w. lemon

Fox 8W

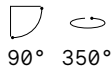
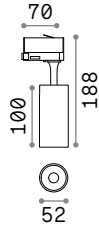

0,300 Kg/0,0015 m³

LED COB BRIDGELUX Driver ON/OFF incluso

CRI ≥ 80

Potenza	Angolo	Lumen	CCT	Finitura	Codice	€
8 W	41°	950 lm	3000 K	Bianco	250410	47,30
				Nero	250403	47,30
8 W	41°	1050 lm	4000 K	Bianco	271453	47,30
				Nero	271446	47,30

CRI ≥ 90

Potenza	Angolo	Lumen	CCT	Finitura	Codice	€
8 W	41°	900 lm	3000 K	Bianco	285368	47,30 <i>new</i>
				Nero	285351	47,30 <i>new</i>



SINGLE CONNECTION

Necessario	Driver	Finitura	Codice	€
No	On/Off	Bianco	170145	26,40
		Nero	170152	26,40



Light beam: ACCENT

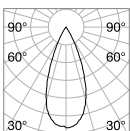

m	lx	Øm
1	2067	0,77
2	517	1,54
3	230	2,30
4	129	3,07
5	83	3,84

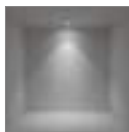

CRI ≥ 80 8W 41° 950lm 3000K



Fox 15W

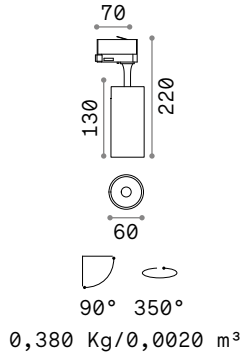

LED COB BRIDGELUX Driver ON/OFF incluso

CRI ≥ 80

Potenza	Angolo	Lumen	CCT	Finitura	Codice	€
15 W	41°	1500 lm	3000 K	Bianco	250434	53,90
				Nero	250427	53,90
15 W	41°	1600 lm	4000 K	Bianco	267784	53,90
				Nero	267777	53,90

CRI ≥ 90

Potenza	Angolo	Lumen	CCT	Finitura	Codice	€
15 W	41°	1450 lm	3000 K	Bianco	285382	53,90 <i>new</i>
				Nero	285375	53,90 <i>new</i>



SINGLE CONNECTION

Necessario	Driver	Finitura	Codice	€
No	On/Off	Bianco	170145	26,40
		Nero	170152	26,40



Light beam: ACCENT

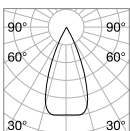

m	lx	Øm
1	3204	0,80
2	801	1,60
3	356	2,40
4	200	3,20
5	128	4,00



CRI ≥ 80 15W 41° 1500lm 3000K



Fox 25W

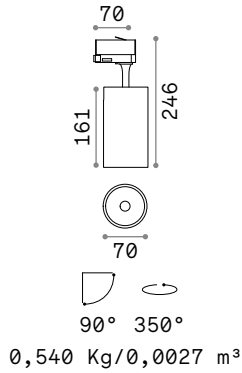

LED COB BRIDGELUX Driver ON/OFF incluso

CRI ≥ 80

Potenza	Angolo	Lumen	CCT	Finitura	Codice	€
25 W	35°	2850 lm	3000 K	Bianco	250458	58,30
				Nero	250441	58,30
		3000 lm	4000 K	Bianco	267807	58,30
				Nero	267791	58,30

CRI ≥ 90

Potenza	Angolo	Lumen	CCT	Finitura	Codice	€
25 W	35°	2650 lm	3000 K	Bianco	285405	58,30 <i>new</i>
				Nero	285399	58,30 <i>new</i>



SINGLE CONNECTION

Necessario	Driver	Finitura	Codice	€
No	On/Off	Bianco	170145	26,40
		Nero	170152	26,40



Light beam: ACCENT

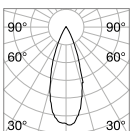

m	lx	Øm
1	8140	0,61
2	2035	1,22
3	904	1,82
4	509	2,43
5	326	3,04



CRI ≥ 80 25W 35° 2500lm 3000K



Eos new

Sorgente	LED COB	CRI	≥90
Potenza	15W / 25W	Durata LED	30.000 h
Driver incluso	On/Off	Classe isolamento	I
Driver disponibili	No	IP	20
Binario	Trifase (standard Eutrac)	Materiale	Alluminio
MacAdam	SDCM 3	Garanzia	5 anni
CCT	3000 K		



LED COB BRIDGELUX Driver ON/OFF incluso

Potenza	Angolo	Lumen	CCT	Finitura	Codice	€
15 W	20-55°	1650 lm	3000 K	Bianco	286594	71,50 <small>new</small>
				Nero	276182	71,50 <small>new</small>



LED COB BRIDGELUX Driver ON/OFF incluso

Potenza	Angolo	Lumen	CCT	Finitura	Codice	€
25 W	20-55°	3200 lm	3000 K	Bianco	286600	88 <small>new</small>
				Nero	276243	88 <small>new</small>



SINGLE CONNECTION

Necessario	Driver	Finitura	Codice	€
No	On/Off	Bianco	170145	26,40
		Nero	170152	26,40



Link - Pagina 612



Light beam: from SPOT to WIDE

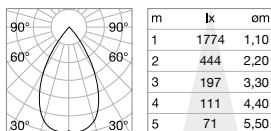

CRI≥90 15W 20-55° 1650lm 3000K

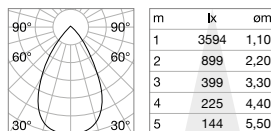

CRI≥90 25W 20-55° 3200lm 3000K







Spot Track - Mouse Track **new**

⊕ IP20 ALLUMINIO

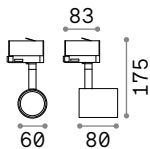

0,250 Kg/0,0016 m³

GU10 Non inclusa - Lampadina consigliata 108292

Potenza	Finitura	Codice	€
max 50W	Bianco	229706	44
	Nero	229720	44
	Ottone Sat.	269634	44 new



P. 300 P. 384

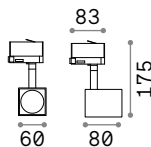

0,300 Kg/0,0027 m³

GU10 Non inclusa - Lampadina consigliata 108292

Potenza	Finitura	Codice	€
max 50W	Bianco	229768	44
	Nero	229782	44
	Ottone Sat.	269597	44 new

⊕ IP20 ALLUMINIO



P. 300 P. 384



SINGLE CONNECTION

Necessario	Driver	Finitura	Codice	€
No	On/Off	Bianco	170145	26,40
		Nero	170152	26,40



Link - Pagina 612



Glim Track - Look Track

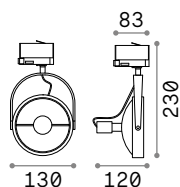

0,320 Kg/0,0180 m³

GU10 Lampadine LED GU10 13W 3000 K incluse. Cod. **189031**

IP20

Potenza	Finitura	Codice	€
max 50W	Bianco	229676	71,50
	Nero	229683	71,50



P. 302

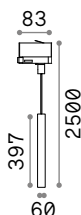

0,930 Kg/0,0037 m³

GU10 Lampadine LED GU10 5W 3000 K incluse. Cod. **108292**

IP20

Potenza	Finitura	Codice	€
max 28W	Bianco	231662	82,50
	Nero	231631	82,50



P. 070



P. 290



P. 357



SINGLE CONNECTION

Necessario	Driver	Finitura	Codice	€
No	On/Off	Bianco	170145	26,40
		Nero	170152	26,40



Link - Pagina 612

Display ^{new}

Proiettore lineare in alluminio adatto per installazione su binario trifase (standard Eutrac), disponibile in tre differenti lunghezze e con verniciatura a polveri in finitura bianca o nera. Il driver di alimentazione integrato è alloggiato all'interno del binario per minimizzare l'ingombro del prodotto visibile. Disponibile nel modello WIDE con ottica piatta e diffondente in PMMA satinato, nel modello UGR con diffusore in PMMA microprismatizzato per il controllo dell'abbagliamento e nel modello ACCENT con riflettori neri (UGR < 16). Sorgenti LED integrate; disponibile in CCT 3000 K e 4000 K; CRI ≥ 80; durata utile LED 50.000 h L70B50; montaggio e smontaggio senza utensili. Adatto per l'illuminazione di UFFICI, spazi COMMERCIALI e aree ESPOSITIVE, ideale in combinazione con altri proiettori da binario a luce focalizzata.

PRO Prodotto ad alto contenuto tecnologico, elevata qualità dei materiali, destinato ad uso professionale.

UGR Articolo con UGR <16 (Accent), <22 (UGR).

Sorgente	LED SMD
Potenza	14W / 40W
Driver incluso	On/Off
Driver disponibili	No
Binario	Trifase (standard Eutrac)
MacAdam	SDCM 3
CCT	3000 K / 4000 K
CRI	≥80
UGR	<16 (Accent) / <22 (UGR)
Durata LED	50.000 h
Classe isolamento	II
IP	20
Materiale	Alluminio
Garanzia	5 anni



[Link - Pagina 612](#)





Display Accent

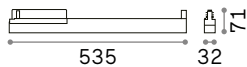

0,400 Kg/0,0064 m³

LED SMD SAMSUNG Driver ON/OFF incluso - UGR <16

Potenza	Angolo	Lumen	CCT	Finitura	Codice	€
14 W	60°	1800 lm	3000 K	Bianco	283593	203,50 <i>new</i>
				Nero	283609	203,50 <i>new</i>
		1900 lm	4000 K	Bianco	283616	203,50 <i>new</i>
				Nero	283623	203,50 <i>new</i>

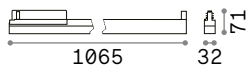

1,120 Kg/0,0112 m³

LED SMD SAMSUNG Driver ON/OFF incluso - UGR <16

Potenza	Angolo	Lumen	CCT	Finitura	Codice	€
28 W	60°	3500 lm	3000 K	Bianco	283524	319 <i>new</i>
				Nero	276267	319 <i>new</i>
		3700 lm	4000 K	Bianco	283531	319 <i>new</i>
				Nero	283548	319 <i>new</i>

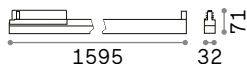

1,570 Kg/0,0173 m³

LED SMD SAMSUNG Driver ON/OFF incluso - UGR <16

Potenza	Angolo	Lumen	CCT	Finitura	Codice	€
40 W	60°	5100 lm	3000 K	Bianco	283555	440 <i>new</i>
				Nero	283562	440 <i>new</i>
		5400 lm	4000 K	Bianco	283579	440 <i>new</i>
				Nero	283586	440 <i>new</i>



Light beam: ACCENT

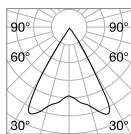

m	lx	Øm
1	1330	1,20
2	332	2,40
3	148	3,50
4	83	4,70
5	53	5,90

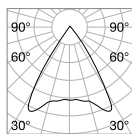
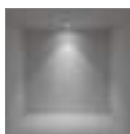

m	lx	Øm
1	2453	1,30
2	613	2,50
3	273	3,80
4	153	5,00
5	96	6,30

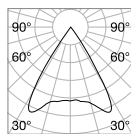

m	lx	Øm
1	3598	1,30
2	900	2,50
3	400	3,80
4	225	5,00
5	144	6,30



CRI≥80 14W 60° 1800lm 3000K

CRI≥80 28W 60° 3500lm 3000K

CRI≥80 40W 60° 5100lm 3000K

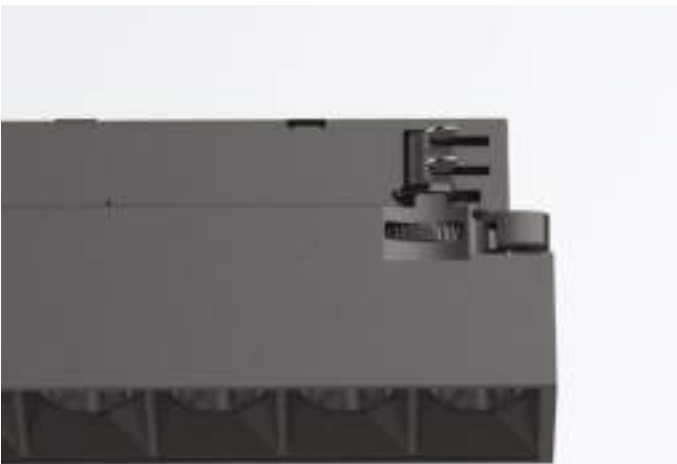

Display Accent 535 mm



Display Accent 1065 mm



Display Accent 1595 mm



Display Wide

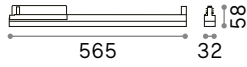

0,420 Kg/0,0067 m³

LED SMD SAMSUNG Driver ON/OFF incluso

Potenza	Angolo	Lumen	CCT	Finitura	Codice	€
21W	125°	2400 lm	3000 K	Bianco	283753	165 <i>new</i>
				Nero	283760	165 <i>new</i>
		2500 lm	4000 K	Bianco	276274	165 <i>new</i>
				Nero	283777	165 <i>new</i>

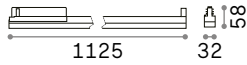

0,770 Kg/0,0124 m³

LED SMD SAMSUNG Driver ON/OFF incluso

Potenza	Angolo	Lumen	CCT	Finitura	Codice	€
40W	125°	4300 lm	3000 K	Bianco	283722	242 <i>new</i>
				Nero	283050	242 <i>new</i>
		4500 lm	4000 K	Bianco	283739	242 <i>new</i>
				Nero	283746	242 <i>new</i>



Light beam: WIDE

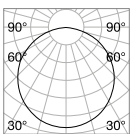

m	lx	Øm
1	473	5,20
2	118	6,50
3	53	9,70
4	30	13,00
5	19	16,00

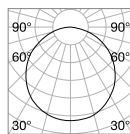

m	lx	Øm
1	897	3,10
2	224	6,10
3	100	9,20
4	56	12,00
5	36	15,00



CRI≥80 21W 125° 2400lm 3000K

CRI≥80 40W 125° 4300lm 3000K



Display Wide 565 mm



Display Wide 1125 mm

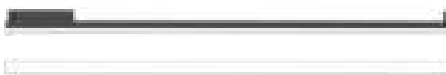

Display UGR

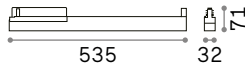

0,400 Kg/0,0064 m³

LED SMD SAMSUNG Driver ON/OFF incluso - UGR <22

Potenza	Angolo	Lumen	CCT	Finitura	Codice	€
14 W	70°	1600 lm	3000 K	Bianco	283685	181,50 <i>new</i>
				Nero	283692	181,50 <i>new</i>
		1700 lm	4000 K	Bianco	283708	181,50 <i>new</i>
				Nero	283715	181,50 <i>new</i>

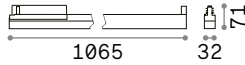

1,120 Kg/0,0112 m³

LED SMD SAMSUNG Driver ON/OFF incluso - UGR <22

Potenza	Angolo	Lumen	CCT	Finitura	Codice	€
27 W	70°	3100 lm	3000 K	Bianco	283647	275 <i>new</i>
				Nero	283630	275 <i>new</i>
		3300 lm	4000 K	Bianco	276281	275 <i>new</i>
				Nero	283258	275 <i>new</i>

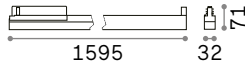

1,570 Kg/0,0173 m³

LED SMD SAMSUNG Driver ON/OFF incluso - UGR <22

Potenza	Angolo	Lumen	CCT	Finitura	Codice	€
40 W	70°	4500 lm	3000 K	Bianco	283654	385 <i>new</i>
				Nero	283067	385 <i>new</i>
		4700 lm	4000 K	Bianco	283661	385 <i>new</i>
				Nero	283678	385 <i>new</i>



Light beam: WIDE

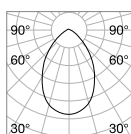

m	lx	Øm
1	854	1,40
2	213	2,80
3	95	4,20
4	53	5,70
5	34	7,10

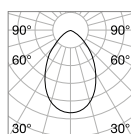
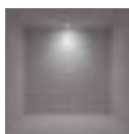

m	lx	Øm
1	1636	1,40
2	409	2,80
3	182	4,20
4	102	5,70
5	65	7,10

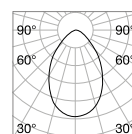

m	lx	Øm
1	2419	1,40
2	605	2,80
3	269	4,20
4	151	5,70
5	97	7,10

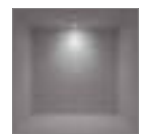

CRI≥80 14W 70° 1600lm 3000K

CRI≥80 27W 70° 3100lm 3000K

CRI≥80 40W 70° 4500lm 3000K

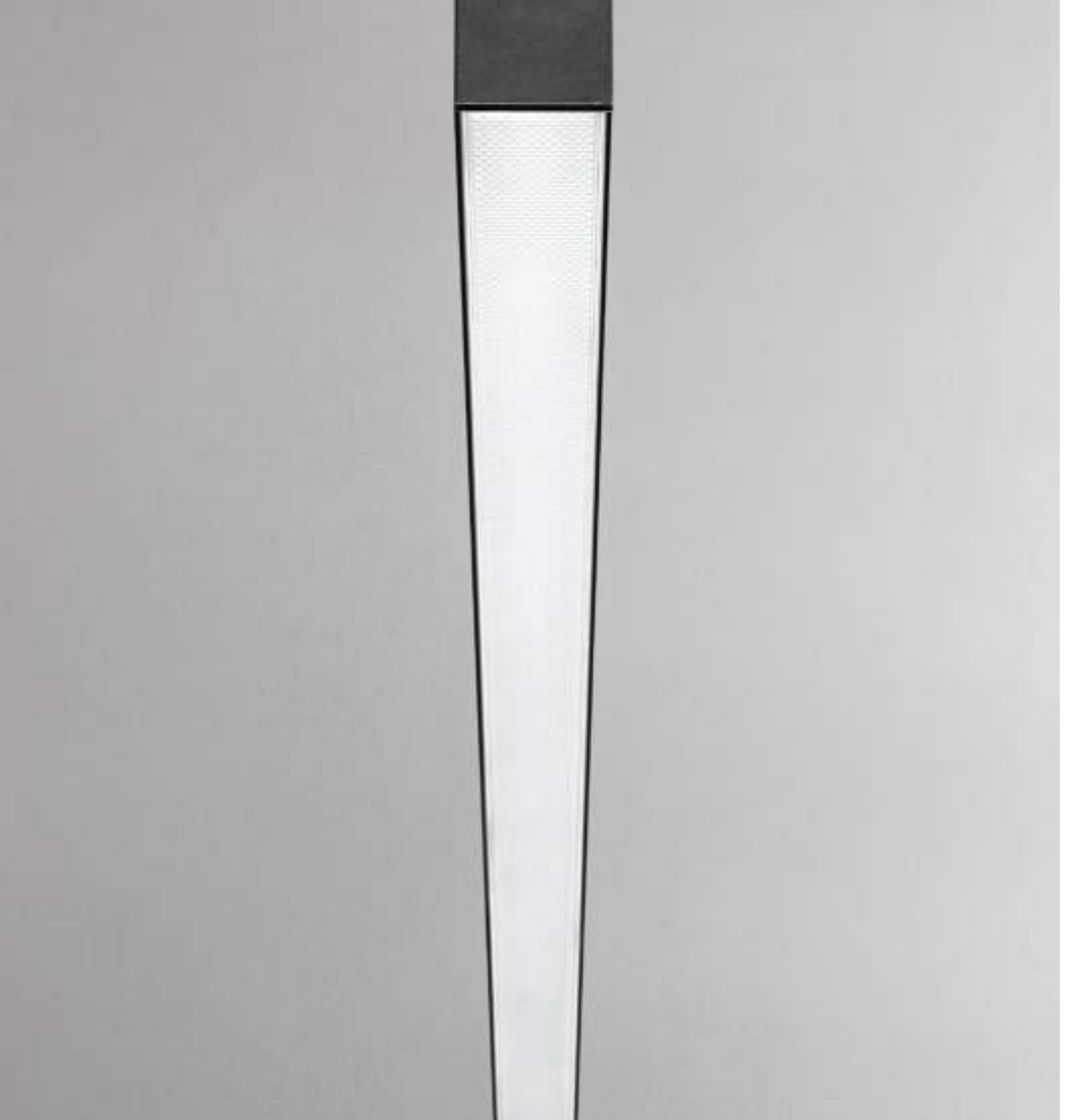

Display UGR 535 mm



Display UGR 1065 mm

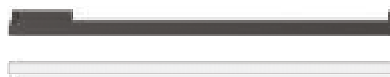

Display UGR 1595 mm



Link

Profilo di alluminio estruso per binari elettrificati trifase; verniciatura a polveri in bianco o nero, ottimizzato per proiettori standard Eutrac; disponibile nelle versioni a plafone, a sospensione oppure a incasso a filo su soffitti di cartongesso; adatto a sistemi di file continue, moduli standard da 2000 mm o 3000 mm. Ideale per l'installazione in grandi ambienti dove viene richiesta grande flessibilità, ad esempio spazi MUSEALI, COMMERCIALI e RETAIL. Garanzia 5 anni.

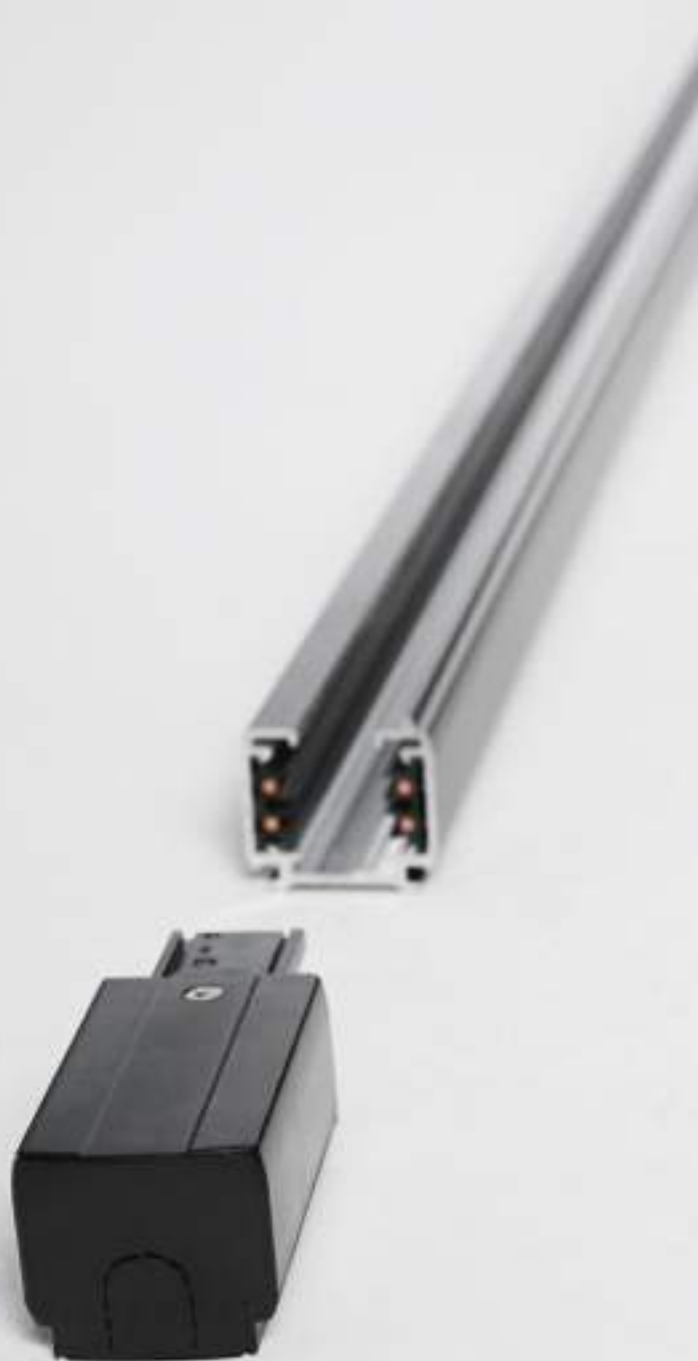



Link Trimless On/Off

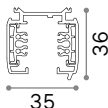
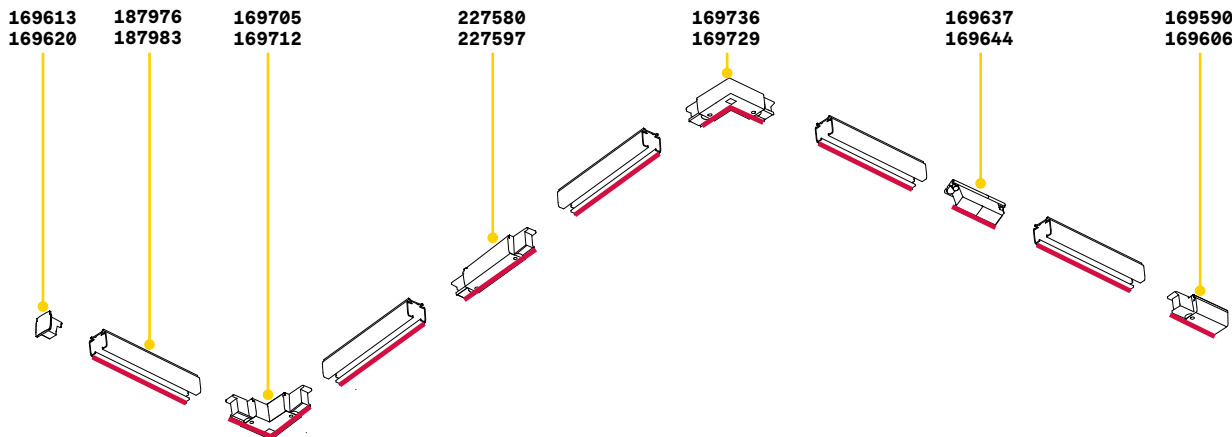

TRACK

Lunghezza	Peso	Volume	Finitura	Codice	€
1000 mm	0,94 Kg	0,0016 m³	Bianco	243269	33
			Nero	243252	33
2000 mm	1,93 Kg	0,0032 m³	Bianco	187976	63,80
			Nero	187983	63,80
3000 mm	2,87 Kg	0,0048 m³	Bianco	187990	99
			Nero	188003	99



KIT SURFACE



SUSPENSION KIT

Necessario	N° Cavi	Lunghezza cavi	Finitura	Codice	€
SI - 1Kitx 1000 mm			Bianco	169972	6,60
			Nero	169989	6,60
SI - 1Kitx 1000 mm	1	3000 mm	Bianco	242705	15,40
			Nero	243283	15,40
	1	5000 mm	Bianco	243245	17,60
			Nero	243238	17,60



MAIN CONNECTOR END

0,060 Kg/0,0002 m³

169583	L	€ 15,40
169576	R	€ 15,40
169590	R	€ 15,40
169606	R	€ 15,40

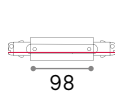

MAIN CONNECTOR MIDDLE

0,120 Kg/0,0004 m³

227580	€ 24,20
227597	€ 24,20

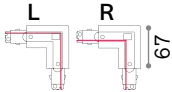

MAIN CONNECTOR CORNER

0,110 Kg/0,0005 m³

169705	L	€ 24,50
169712	R	€ 24,50
169736	R	€ 24,50
169729	R	€ 24,50

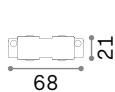

ELECTRIFIED CONNECTOR

0,030 Kg/0,0001 m³

169637	€ 7,70
169644	€ 7,70



END CAP

0,010 Kg/0,0001 m³

169613	€ 3,30
169620	€ 3,30

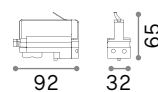

TRACK ADAPTOR

0,080 Kg/0,0002 m³

194257	€ 12,10
194301	€ 12,10

Link Trimless DALI - 1-10V

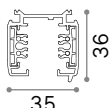
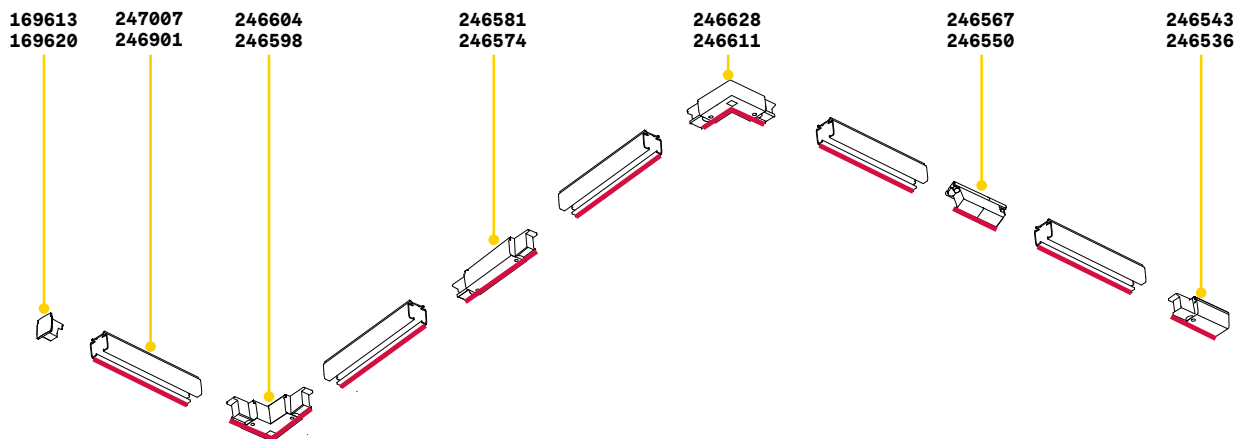

TRACK

Lunghezza	Peso	Volume	Finitura	Codice	€
1000 mm	0,94 Kg	0,0016 m³	Bianco	246468	36,30
			Nero	246451	36,30
2000 mm	1,93 Kg	0,0032 m³	Bianco	247007	69,30
			Nero	246901	69,30
3000 mm	2,87 Kg	0,0048 m³	Bianco	247625	102,30
			Nero	247618	102,30

Necessario	N° Cavi	Lunghezza cavi	Finitura	Codice	€
SI - 1 Kit x 1000 mm			Bianco	169972	6,60
			Nero	169989	6,60
SI - 1 Kit x 1000 mm	1	3000 mm	Bianco	242705	15,40
			Nero	243283	15,40
	1	5000 mm	Bianco	243245	17,60
			Nero	243238	17,60



KIT SURFACE



SUSPENSION KIT

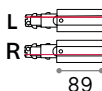

MAIN CONNECTOR END

0,079 Kg/0,0002 m³

- 246529 █ L € 16,50
- 246512 █ L € 16,50
- 246543 █ R € 16,50
- 246536 █ R € 16,50

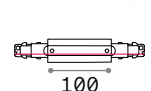

MAIN CONNECTOR MIDDLE

0,129 Kg/0,0004 m³

- 246581 █ € 27,50
- 246574 █ € 27,50

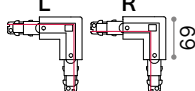

MAIN CONNECTOR CORNER

0,130 Kg/0,0006 m³

- 246604 █ L € 28,60
- 246598 █ L € 28,60
- 246628 █ R € 28,60
- 246611 █ R € 28,60

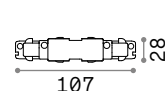

ELECTRIFIED CONNECTOR

0,041 Kg/0,0001 m³

- 246567 █ € 11
- 246550 █ € 11

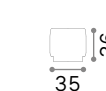

END CAP

0,010 Kg/0,0001 m³

- 169613 █ € 3,30
- 169620 █ € 3,30

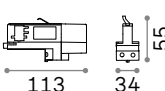

TRACK ADAPTOR

0,063 Kg/0,0003 m³

- 246505 █ € 18,70
- 246499 █ € 18,70

Link Trim On/Off

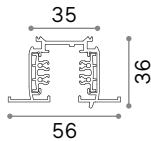
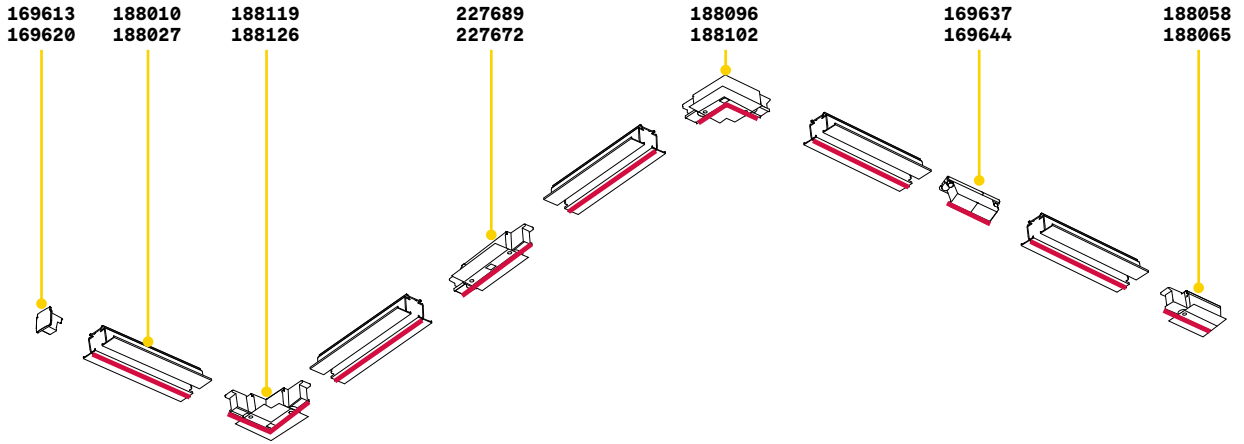

TRACK

Lunghezza	Peso	Volume	Finitura	Codice	€
2000 mm	2,11 Kg	0,0048 m ³	Bianco	188010	68,20
			Nero	188027	68,20



KIT RECESSED

Necessario	Codice	€
SI - 1Kitx 1000 mm	188195	5,50

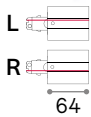

MAIN CONNECTOR END

0,070 Kg/0,0002 m³

188072	L	€ 17,60
188089	L	€ 17,60
188058	R	€ 17,60
188065	R	€ 17,60

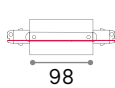

MAIN CONNECTOR MIDDLE

0,130 Kg/0,0004 m³

227689	€ 28,60
227672	€ 28,60

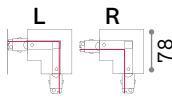

MAIN CONNECTOR CORNER

0,120 Kg/0,0006 m³

188119	L	€ 27,50
188126	L	€ 27,50
188096	R	€ 27,50
188102	R	€ 27,50

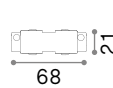

ELECTRIFIED CONNECTOR

0,030 Kg/0,0001 m³

169637	€ 7,70
169644	€ 7,70



END CAP

0,010 Kg/0,0001 m³

169613	€ 3,30
169620	€ 3,30

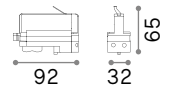

TRACK ADAPTOR

0,080 Kg/0,0002 m³

194257	€ 12,10
194301	€ 12,10

Link Trim DALI - 1-10V

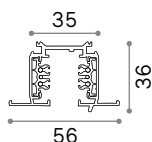
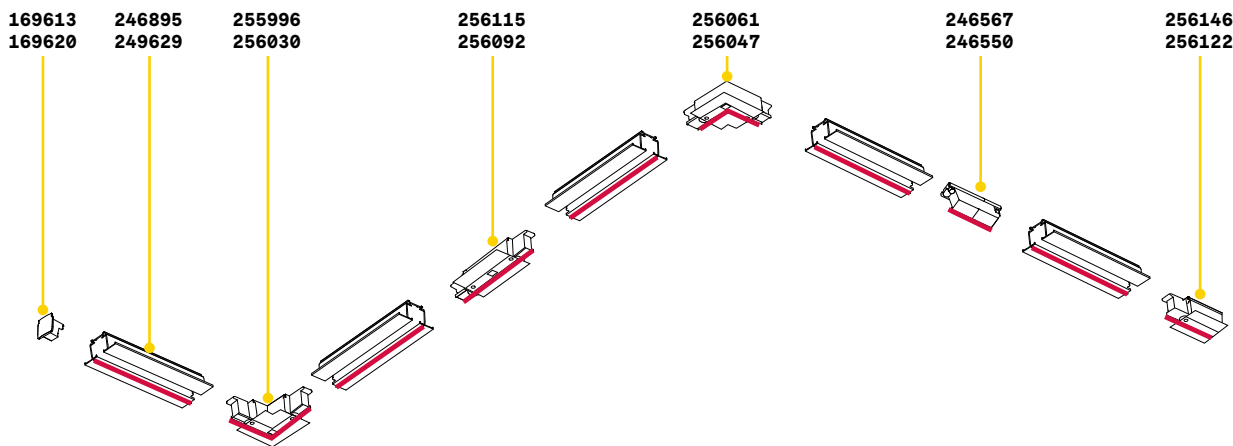

TRACK

Lunghezza	Peso	Volume	Finitura	Codice	€
2000 mm	2,11 Kg	0,0048 m ³	Bianco	246895	75,90
			Nero	249629	75,90



KIT RECESSED

Necessario	Codice	€
SI - 1 Kit x 1000 mm	188195	5,50

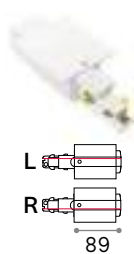

MAIN CONNECTOR END

0,089 Kg/0,0004 m³

256085	L	€ 18,70
256078	L	€ 18,70
256146	R	€ 18,70
256122	R	€ 18,70

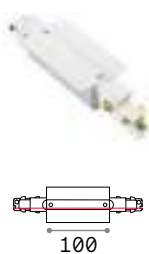

MAIN CONNECTOR MIDDLE

0,145 Kg/0,0005 m³

256115	€ 30,80
256092	€ 30,80

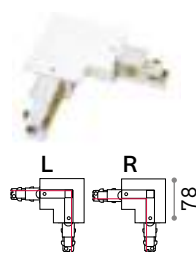

MAIN CONNECTOR CORNER

0,143 Kg/0,0006 m³

256030	L	€ 30,80
255996	L	€ 30,80
256061	R	€ 30,80
256047	R	€ 30,80



ELECTRIFIED CONNECTOR

0,041 Kg/0,0001 m³

246567	€ 11
246550	€ 11



END CAP

0,010 Kg/0,0001 m³

169613	€ 3,30
169620	€ 3,30



TRACK ADAPTOR

0,063 Kg/0,0003 m³

246505	€ 18,70
246499	€ 18,70































Interni

Lampade da incasso

Indice alfabetico

Basic	652
Bento	620
Blues	678
Channel	661
Deep	650
Dynamic	626
Eye	672
Funky	676
Game	634
Groove	658
Jazz	676
Led Panel	664
Lika	666
Lounge	676
Nova	662
Off	646
One	642
Play	660
Polka	680
Quark	645
Room-33	640
Room-65	677
Samba	674
Soul	679
Swing	676
Virus	644
Walky	681
Zephyr	673

Indice icone

<small>new</small>			<small>new</small>			<small>new</small>	
Bento 620	Dynamic 626	Game 634	Room-33 640	One 642			
							
Virus 644	Quark 645	Off 646	Deep 650	Basic 652			
							
Groove 658	Play 660	Channel 661	Nova 662	Led Panel 664			
							
Lika 666	Eye 672	Zephyr 673	Samba 674	Jazz 676			
							
Swing 676	Lounge 676	Funky 676	Room-65 677	Blues 678			
							
Soul 679	Soul 679	Polka 680	Walky 681				

Bento **new**

Sistema componibile di elementi ad incasso costituito da sorgente orientabili, riflettore e ghiera, con lenti e accessori schermanti in opzione; finitura bianca e nera; ghiera a incasso disponibile in forma singola rotonda o quadrata, oppure rettangolare in versione doppia o tripla per l'installazione di sorgenti multiple e indipendenti; anello anti-abbagliamento opzionale per arretramento della sorgente in modalità non orientabile; tre diversi angoli di emissione a scelta. Sorgente luminosa con tecnologia COB LED integrato per la massima efficienza, disponibile con una temperatura di colore di 3000 K; LED ad efficienza energetica ad elevata resa cromatica; CRI ≥ 90 ; binning iniziale ≤ 3 -Step MacAdam; classe isolamento II; durata utile LED 50.000 h L70B50. Disponibile in versione dimmerabile sia DALI che 1-10V. Per la sua dimensione compatta e grande versatilità è ottimale nelle installazioni di ambienti interni DOMESTICI, DIREZIONALI e RETAIL.

PRO

Prodotto ad alto contenuto tecnologico, elevata qualità dei materiali, destinato ad uso professionale.

UGR









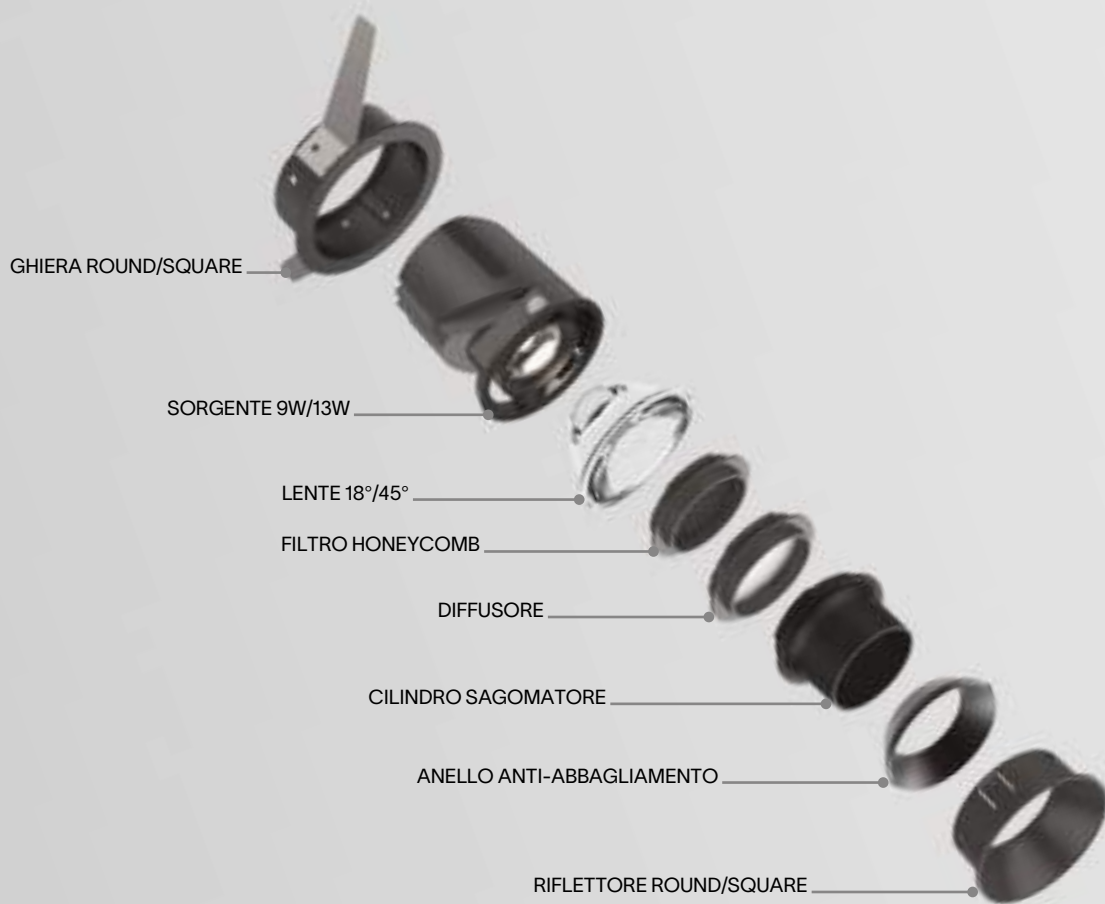

Articolo con UGR <19.

Sorgente	LED COB
Potenza	9W / 13W
Driver incluso	On/Off
Driver disponibili	1-10V / DALI / Push
MacAdam	SDCM 3
CCT	3000 K
CRI	≥ 90
UGR	<19
Durata LED	50.000 h
Classe isolamento	II
IP	20
Materiale	Alluminio
Garanzia	5 anni







		Necessario	Angolo	Finitura		Codice	€
	LENS	No	18°	Trasparen.		287942	3,30 <i>new</i>
			45°	Trasparen.		279626	3,30 <i>new</i>
	FILTER HONEYCOMB	No		Nero		279718	3,30 <i>new</i>
	DIFFUSER	No		Nero		279725	2,75 <i>new</i>
	SNOOT	No		Nero		279701	2,75 <i>new</i>
	ANTI-GLARE RING			Bianco		288147	2,75 <i>new</i>
				Nero		279695	2,75 <i>new</i>

Bento - Source

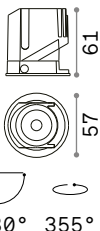

0,180 Kg/0,0003 m³

LED COB CITIZEN Necessario - Driver TRIDONIC ON/OFF incluso

Potenza	Angolo	Lumen	CCT	Finitura	Codice	€
9W	36°	850lm	3000K	Nero	279596	44 <small>new</small>

DIMMABLE DRIVER* Optional

	Potenza	Output	Misura (LxHxP)	Codice	€
1-10V	12W	250 mA	122x40x25 mm	287843	44 <small>new</small>
DALI/ Push	20W	250 mA	120x51x29 mm	287850	71,50 <small>new</small>

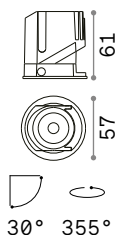

0,200 Kg/0,0003 m³

LED COB CITIZEN Necessario - Driver TRIDONIC ON/OFF incluso

Potenza	Angolo	Lumen	CCT	Finitura	Codice	€
13W	36°	1100lm	3000K	Nero	279602	49,50 <small>new</small>

DIMMABLE DRIVER* Optional

	Potenza	Output	Misura (LxHxP)	Codice	€
1-10V/ Push	20W	350 mA	108x52x22 mm	287867	60,50 <small>new</small>
DALI/ Push	20W	350 mA	120x51x29 mm	287874	71,50 <small>new</small>



Light beam: **ACCENT**

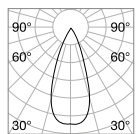

m	lx	Øm
1	1312	0,71
2	328	1,40
3	146	2,10
4	82	2,80
5	52	3,50



CRI≥90 9W 36° 850lm 3000K

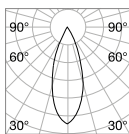

m	lx	Øm
1	1846	0,65
2	461	1,30
3	205	1,90
4	115	2,60
5	74	3,20



CRI≥90 13W 36° 1100lm 3000K

* Gli alimentatori dimmerabili devono essere ordinati contestualmente al prodotto e verranno già inclusi all'interno degli apparecchi in sostituzione degli alimentatori on-off.
** Lente 36° inclusa.

Bento - Frame and Reflector

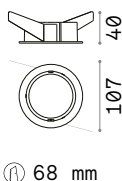

0,060 Kg/0,0007 m³

ROUND - FRAME SINGLE Necessario

Finitura	Codice	€
Bianco	287898	11 <small>new</small>
Nero	287881	11 <small>new</small>

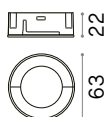

0,020 Kg/0,0001 m³

ROUND - REFLECTOR Necessario

Finitura	Codice	€
Bianco	279633	5,50 <small>new</small>
Nero	279640	5,50 <small>new</small>

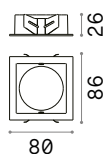

68 x 68 mm

0,050 Kg/0,0002 m³

SQUARE - FRAME SINGLE Necessario

Finitura	Codice	€
Bianco	287911	13,20 <small>new</small>
Nero	287904	13,20 <small>new</small>

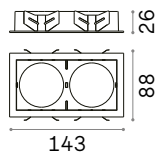

134 x 71 mm

0,110 Kg/0,0004 m³

SQUARE - FRAME TWIN Necessario

Finitura	Codice	€
Bianco	287935	22 <small>new</small>
Nero	280233	22 <small>new</small>

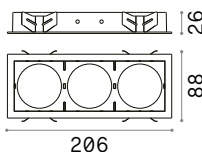

197 x 71 mm

0,300 Kg/0,0006 m³

SQUARE - FRAME TRIPLE Necessario

Finitura	Codice	€
Bianco	287928	27,50 <small>new</small>
Nero	280240	27,50 <small>new</small>

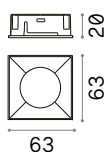

0,020 Kg/0,0001 m³

SQUARE - REFLECTOR Necessario

Finitura	Codice	€
Bianco	279671	7,70 <small>new</small>
Nero	279688	7,70 <small>new</small>

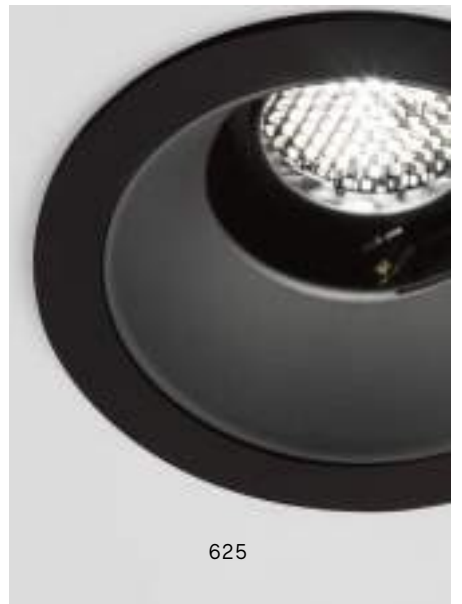

Dynamic

Sistema componibile di elementi ad incasso in alluminio costituito da sorgente, riflettore e ghiera, con lenti e schermi in opzione; finitura bianca, cromo, nera, oro; incasso possibile di forma rotonda o quadrata, riflettore simmetrico o asimmetrico; tre diversi angoli di emissione a scelta. Sorgente luminosa con tecnologia COB LED integrato per la massima efficienza, disponibile con una temperatura di colore di 2700 K, 3000 K o 4000 K; LED ad efficienza energetica ad elevata resa cromatica; CRI ≥ 90 ; binning iniziale ≤ 3 -Step MacAdam; protezione frontale IP54 (a prodotto installato); classe isolamento II; durata utile LED 50.000 h L70B50. Disponibile in versione dimmerabile sia DALI che 1-10V. Per la sua dimensione compatta e grande versatilità è ottimale nelle installazioni di ambienti interni DOMESTICI, DIREZIONALI e RETAIL.

PRO Prodotto ad alto contenuto tecnologico, elevata qualità dei materiali, destinato ad uso professionale.

UGR Articolo con UGR <19.

IP54 Grado di protezione IP54.

Sorgente	LED COB
Potenza	9W / 10W / 15W
Driver incluso	On/Off
Driver disponibili	1-10V / DALI / Push
MacAdam	SDCM 3
CCT	2700 K / 3000 K / 4000 K
CRI	≥ 90
UGR	<19
Durata LED	50.000 h
Classe isolamento	II
IP	54
Materiale	Alluminio
Garanzia	5 anni





		Necessario	Angolo	Finitura		Codice	€
	LENS	No	20°	Trasparen.		211763	6,60
			55°	Trasparen.		211770	6,60
	FILTER HONEYCOMB	No		Nero		208671	6,60
	FILTER ELLIPTICAL	No		Trasparen.		208688	6,60
	GU10 ADAPTOR WITH LAMPHOLDER INCLUDED - IP20	No		Bianco		208640	15,40
				Nero		208657	15,40



Light beam: ACCENT

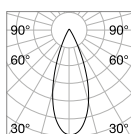

m	lx	Øm
1	1653	0,72
2	413	1,44
3	184	2,16
4	103	2,88
5	66	3,60



CRI≥90 9W 35° 10001m 3000K

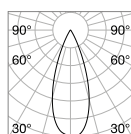

m	lx	Øm
1	1643	0,66
2	410	1,32
3	182	1,98
4	102	2,64
5	65	3,30



CRI≥90 10W 35° 12501m 3000K

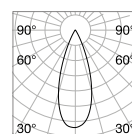

m	lx	Øm
1	2294	0,64
2	573	1,29
3	254	1,93
4	143	2,58
5	91	3,23



CRI≥90 15W 35° 16001m 3000K

Dynamic - Source

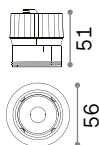

0,180 Kg/0,0030 m³

LED COB CITIZEN Necessario - Driver TRIDONIC ON/OFF incluso

Potenza	Angolo	Lumen	CCT	Finitura	Codice	€
9W	35°	950 lm	2700 K	Nero	252971	44
		1000 lm	3000 K	Nero	252988	44
		1050 lm	4000 K	Nero	252995	44

DIMMABLE DRIVER* Optional

	Potenza	Output	Misura (LxHxP)	Codice	€
1-10V	12 W	200 mA	125 x 45 x 27 mm	253008	42,90
DALI	11 W	200 mA	135 x 30 x 20 mm	253015	63,80

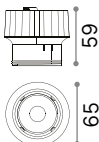

0,150 Kg/0,0030 m³

LED COB CITIZEN Necessario - Driver TRIDONIC ON/OFF incluso

Potenza	Angolo	Lumen	CCT	Finitura	Codice	€
10 W	35°	1150 lm	2700 K	Nero	208541	64,90
		1250 lm	3000 K	Nero	208558	64,90
		1300 lm	4000 K	Nero	208565	64,90

DIMMABLE DRIVER* Optional

	Potenza	Output	Misura (LxHxP)	Codice	€
1-10V	10 W	250 mA	135 x 20 x 30 mm	216317	24,20
DALI/Push	17 W	250 mA	130 x 30 x 43 mm	216027	106,70

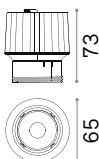

0,200 Kg/0,0030 m³

LED COB CITIZEN Necessario - Driver TRIDONIC ON/OFF incluso

Potenza	Angolo	Lumen	CCT	Finitura	Codice	€
15 W	35°	1500 lm	2700 K	Nero	208572	85,80
		1600 lm	3000 K	Nero	208589	85,80
		1700 lm	4000 K	Nero	208596	85,80

DIMMABLE DRIVER* Optional

	Potenza	Output	Misura (LxHxP)	Codice	€
1-10V	20 W	350 mA	101 x 29 x 51 mm	216324	48,40
DALI/Push	17 W	350 mA	130 x 30 x 43 mm	216263	114,40

* Gli alimentatori dimmerabili devono essere ordinati contestualmente al prodotto e verranno già inclusi all'interno degli apparecchi in sostituzione degli alimentatori on-off. ** Lente 35° inclusa.

Dynamic Round

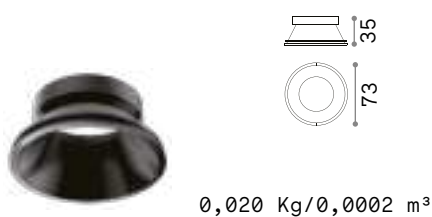
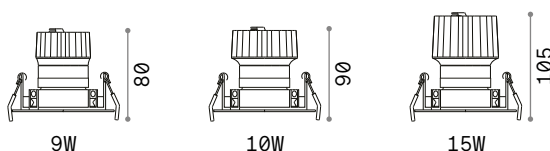

0,020 Kg/0,0002 m³

REFLECTOR Necessario

SIMMETRICO

Finitura	Codice	€
Bianco	211787	7,70
Cromo	221649	8,80
Nero	211794	7,70
Oro	211800	7,70



0,020 Kg/0,0002 m³

ASIMMETRICO - 30°

Finitura	Codice	€
Bianco	211848	7,70
Cromo	221663	9,90
Nero	211855	7,70
Oro	211862	7,70



⌀ 80 mm
0,060 Kg/0,0004 m³

FRAME Necessario

Finitura	Codice	€
Bianco	208695	16,50
Cromo	221687	18,70
Nero	208701	16,50
Oro	208718	16,50



Dynamic Square

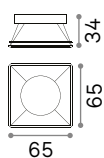
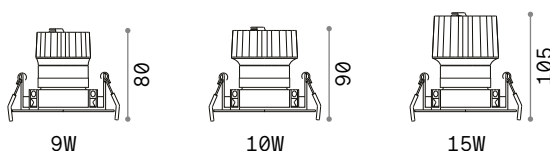

0,020 Kg/0,0002 m³

REFLECTOR Necessario

SIMMETRICO

Finitura	Codice	€
Bianco	211817	7,70
Cromo	221656	8,80
Nero	211824	7,70
Oro	211831	7,70

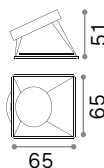

0,020 Kg/0,0002 m³

ASIMMETRICO - 30°

Finitura	Codice	€
Bianco	211879	7,70
Cromo	221670	9,90
Nero	211886	7,70
Oro	211893	7,70

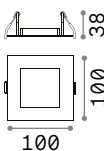

① 90 mm
0,050 Kg/0,0004 m³

FRAME Necessario

Finitura	Codice	€
Bianco	208725	18,70
Cromo	221694	22
Nero	208732	18,70
Oro	208749	18,70

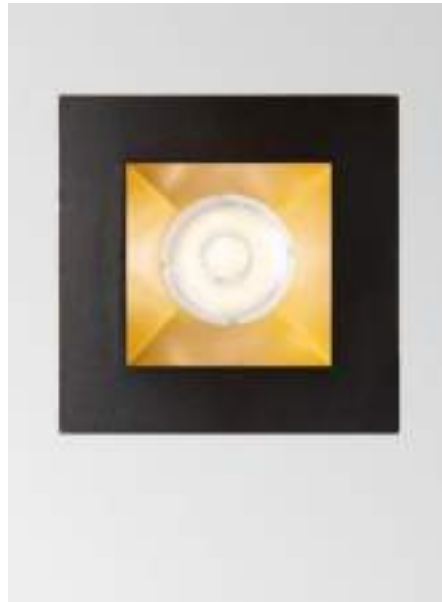

Game **new**

Faretto ad incasso in alluminio pressofuso con ghiera rotonda o quadrata, adatto per installazione su soffitti in cartongesso.

Finitura cromata opaca, bianca opaca RAL 9001, nera opaca RAL 9011, oro opaca RAL 1032. Tecnologia COB-Chip On Board per la massima efficienza; disponibile in temperatura di colore 2700 K, 3000 K o 4000 K. Montaggio e smontaggio senza utensili; protezione IP20; classe isolamento II; durata utile LED 30.000 h L70B50. In opzione dimmerabile 1-10V e DALI.



Articolo con UGR <19.

Sorgente	LED COB
Potenza	11W / 20W
Driver incluso	On/Off
Driver disponibili	1-10V / DALI
CCT	2700 K / 3000 K / 4000 K
CRI	≥80 / ≥90
UGR	<19
Durata LED	30.000 h
Classe isolamento	II
IP	20
Materiale	Alluminio
Garanzia	5 anni





Game Round

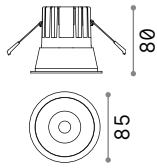

⌀ 74 mm
0,280 Kg/0,0011 m³

LED COB CREE Driver ON/OFF incluso - CRI ≥80

Potenza	Angolo	Lumen	CCT	Finitura	Codice	€
11W	36°	830 lm	2700 K	Bianco	+ 285429	45,10 <i>new</i>
		1000 lm	3000 K	Argento	+ 192284	45,10
				Bianco	+ 192291	45,10
				Nero	+ 192277	45,10
				Oro	+ 192307	45,10
			4000 K	Bianco	+ 267975	45,10

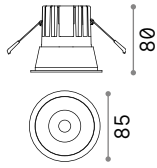

⌀ 74 mm
0,280 Kg/0,0011 m³

LED COB CREE Driver ON/OFF incluso - CRI ≥80

Potenza	Angolo	Lumen	CCT	Finitura	Codice	€
11W	36°	830 lm	2700 K	Nero	+ 285412	45,10 <i>new</i>
		1000 lm	3000 K	Argento	+ 192321	45,10
				Bianco	+ 192338	45,10
				Nero	+ 192314	45,10
				Oro	+ 192345	45,10
			4000 K	Nero	+ 267968	45,10

DIMMABLE DRIVER* Optional

	Potenza	Output	Misura (L x H x P)	Codice	€
1-10V	12W	250 mA	150 x 43 x 29 mm	217253	38,50
DALI	11W	250 mA	135 x 20 x 30 mm	202396	55

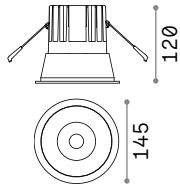

⌀ 110 mm
0,660 Kg/0,0033 m³

LED COB BRIDGELUX Driver ON/OFF incluso - CRI ≥90

Potenza	Angolo	Lumen	CCT	Finitura	Codice	€
20W	24°	2350 lm	3000 K	Bianco	+ 273174	88 <i>new</i>
				Nero	+ 273167	88 <i>new</i>



Light beam: **ACCENT**



Light beam: **SPOT**

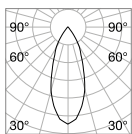

m	lx	cm
1	1545	0,69
2	386	1,38
3	171	2,07
4	96	2,77
5	61	3,46

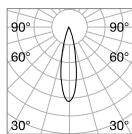
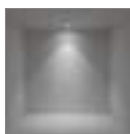

m	lx	cm
1	8645	0,41
2	2161	0,83
3	961	1,20
4	540	1,70
5	346	2,10

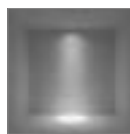

CRI≥90 11W 36° 850lm 3000K

CRI≥90 20W 24° 1850lm 3000K

* Gli alimentatori dimmerabili devono essere ordinati contestualmente al prodotto e verranno già inclusi all'interno degli apparecchi in sostituzione degli alimentatori on-off.



Game Square

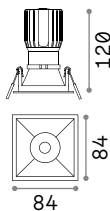

75 x 75 mm
0,270 Kg/0,0011 m³

LED COB CREE Driver ON/OFF incluso - CRI ≥80

Potenza	Angolo	Lumen	CCT	Finitura	Codice	€
11W	36°	830 lm	2700 K	Bianco +	285443	45,10 <i>new</i>
		1000 lm	3000 K	Bianco +	192376	45,10
				Nero +	192352	45,10

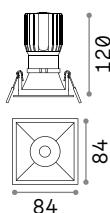

75 x 75 mm
0,270 Kg/0,0011 m³

LED COB CREE Driver ON/OFF incluso - CRI ≥80

Potenza	Angolo	Lumen	CCT	Finitura	Codice	€
11W	36°	830 lm	2700 K	Nero +	285436	45,10 <i>new</i>
		1000 lm	3000 K	Bianco +	192406	45,10
				Nero +	192383	45,10

DIMMABLE DRIVER* Optional

	Potenza	Output	Misura (LxHxP)	Codice	€
1-10V	12 W	250 mA	150 x 43 x 29 mm	217253	38,50
DALI	11W	250 mA	135 x 20 x 30 mm	202396	55



Light beam: ACCENT

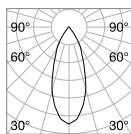

m	lx	øm
1	1545	0,69
2	386	1,38
3	171	2,07
4	96	2,77
5	61	3,46



CRI≥90 11W 36° 850lm 3000K

* Gli alimentatori dimmerabili devono essere ordinati contestualmente al prodotto e verranno già inclusi all'interno degli apparecchi in sostituzione degli alimentatori on-off.



Room-33

Sorgente	LED COB	UGR	<13
Potenza	11W	Durata LED	50.000 h
Driver incluso	On/Off	Classe isolamento	II
Driver disponibili	No	IP	44
MacAdam	SDCM 3	Materiale	Alluminio
CCT	2700 K	Garanzia	5 anni
CRI	≥80		

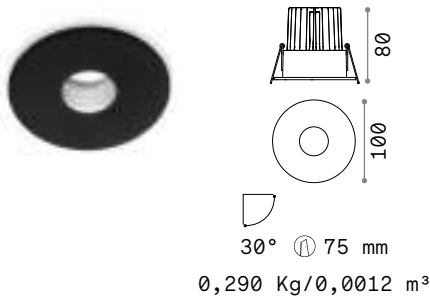

LED COB Driver ON/OFF incluso

Potenza	Angolo	Lumen	CCT	Finitura	Codice	€
11W	20°	930 lm	2700 K	Bianco	251943	55
				Nero	251950	55

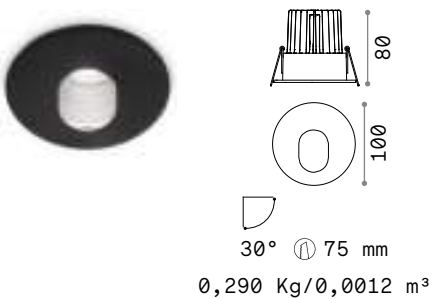

LED COB Driver ON/OFF incluso

Potenza	Angolo	Lumen	CCT	Finitura	Codice	€
11W	20°	930 lm	2700 K	Bianco	251967	55
				Nero	251981	55

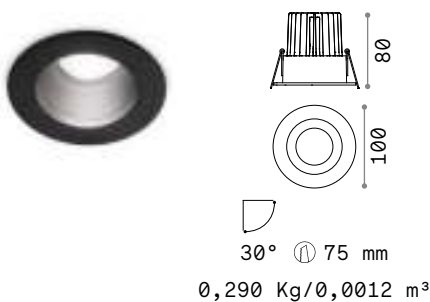

LED COB Driver ON/OFF incluso

Potenza	Angolo	Lumen	CCT	Finitura	Codice	€
11W	20°	930 lm	2700 K	Bianco	251998	55
				Nero	252018	55

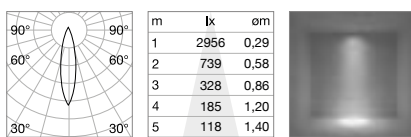

CRI≥80 9W 20° 930lm 2700K

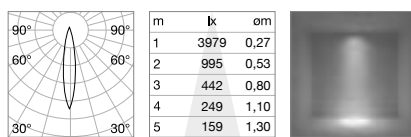

CRI≥80 9W 20° 930lm 2700K

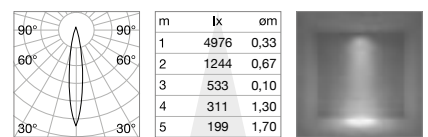

CRI≥80 9W 20° 930lm 2700K

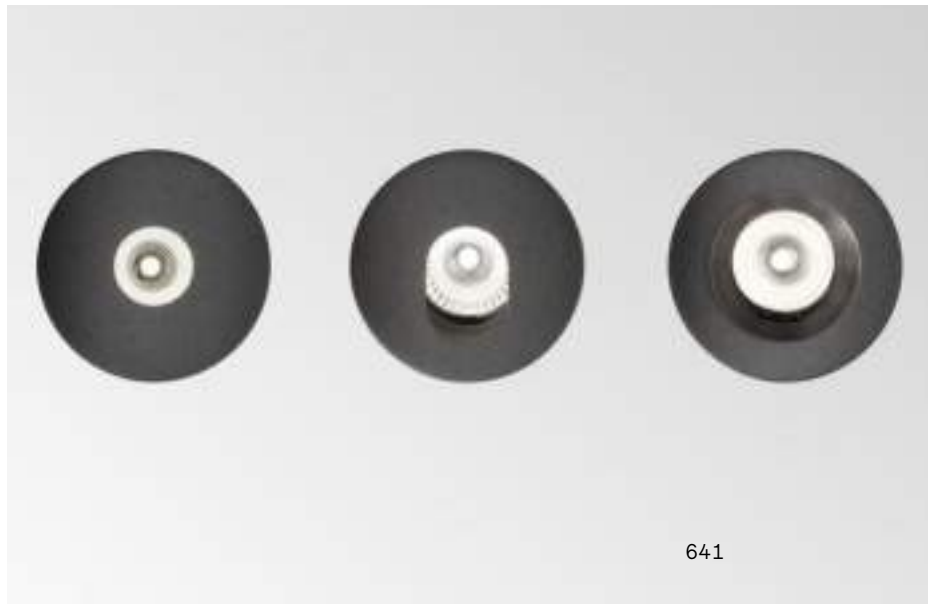

One new

Sorgente	LED SMD	Durata LED	30.000 h
Potenza	2W / 3W	Classe isolamento	II
Driver incluso	On/Off	IP	20
Driver disponibili	No	Materiale	Alluminio
CCT	3000 K	Garanzia	5 anni
CRI	≥95		

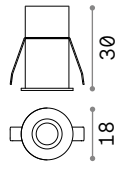

⌀ 17 mm
0,050 Kg/0,0001 m³

LED SMD Driver ON/OFF incluso*

Potenza	Angolo	Lumen	CCT	Finitura	Codice	€
2W	25°	130 lm	3000 K	Bianco	274768	30,80 <small>new</small>

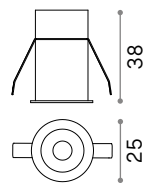

⌀ 25 mm
0,070 Kg/0,0001 m³

LED SMD Driver ON/OFF incluso*

Potenza	Angolo	Lumen	CCT	Finitura	Codice	€
2W	30°	130 lm	3000 K	Bianco	274775	35,20 <small>new</small>

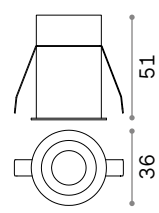

⌀ 35 mm
0,100 Kg/0,0003 m³

LED SMD Driver ON/OFF incluso*

Potenza	Angolo	Lumen	CCT	Finitura	Codice	€
3W	25°	270 lm	3000 K	Bianco	274782	39,60 <small>new</small>



Light beam: SPOT

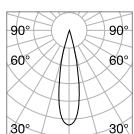

m	lx	øm
1	372	0,40
2	93	0,81
3	41	1,20
4	23	1,60
5	15	2,00

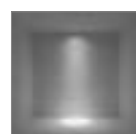

CRI≥95 2W 25° 651m 3000K



Light beam: SPOT

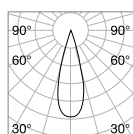

m	lx	øm
1	307	0,53
2	77	1,10
3	34	1,60
4	19	2,10
5	12	2,70



CRI≥95 2W 30° 701m 3000K



Light beam: SPOT

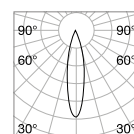

m	lx	øm
1	866	0,40
2	216	0,80
3	96	1,20
4	54	1,60
5	35	2,00

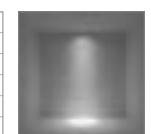

CRI≥95 3W 25° 651m 3000K

* Misure L 38,3 x H 16,5 x P 19,3 mm





Virus

☐ IP20 CRI≥90 30.000 h ALLUMINIO

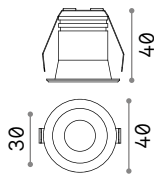

⌀ 30 mm
0,070 Kg/0,0003 m³

LED SMD OSRAM AND DRIVER Incluso

Potenza	Angolo	Lumen	CCT	Finitura	Codice	€
3W	20°	210 lm	3000 K	Bianco +	244808	30,80
				Oro +	244822	30,80
				Nero +	244846	30,80
				Oro +	244853	30,80



Light beam: SPOT

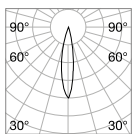

m	lx	Øm
1	1374	0,30
2	344	0,60
3	153	0,91
4	86	1,20
5	55	1,50

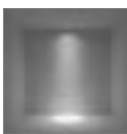

CRI≥90 3W 20° 210lm 3000K



244808



244822



244846



244853

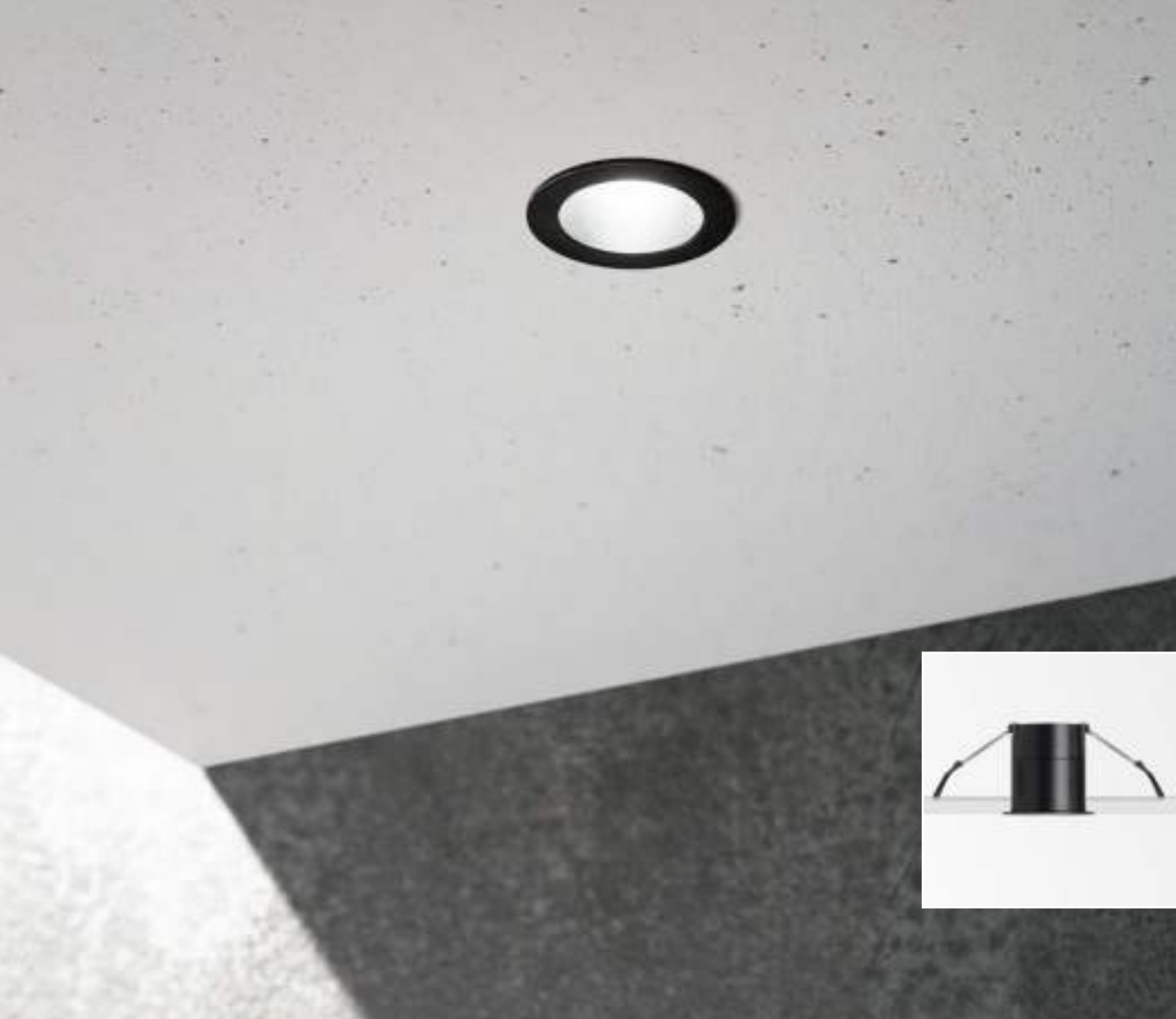

Quark

☐ IP20 CRI ≥80 50.000 h ALLUMINIO

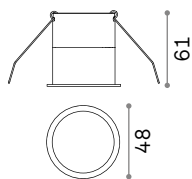

⌀ 45 mm

0,170 Kg/0,0005 m³

LED COB CITIZEN AND DRIVER Incluso

Potenza	Angolo	Lumen	CCT	Finitura	Codice	€
8 W	30°	550 lm	3000 K	Bianco	☐ 258478	57,20
				Nero	■ 258461	57,20



Light beam: ACCENT

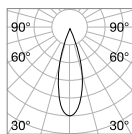

m	lx	Øm
1	1446	0,54
2	362	1,10
3	161	1,60
4	90	2,20
5	56	2,70

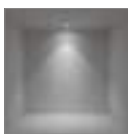

CRI ≥80 8W 30° 550lm 3000K

Off

Incasso fisso in alluminio pressofuso con ghiera rotonda in tre dimensioni, adatto per installazione su soffitti in cartongesso. Finitura nera opaca RAL 9005 e bianca opaca RAL 9016, LED integrati raffreddati passivamente; tecnologia COB (Chip on Board) per la massima efficienza; UGR < 19; binning iniziale ≤ 3-Step MacAdam; disponibile in temperatura di colore 3000 K e 4000 K; CRI ≥ 90; protezione frontale IP54 (a prodotto installato); classe isolamento II; in opzione dimmerabile 1-10V, DALI e Push; durata utile LED 50.000 h L80B50. Adatto per UFFICI e ambienti DIREZIONALI e in generale dove vi sia la presenza di videotermini e la necessità di garantire un controllo dell'abbagliamento elevato. L'elevata resa cromatica lo rende ideale anche per gli spazi espositivi e la valorizzazione della merce in showroom e aree vendita nel settore RETAIL.

PRO Prodotto ad alto contenuto tecnologico, elevata qualità dei materiali, destinato ad uso professionale.

UGR Articolo con UGR <19.

IP54 Grado di protezione IP54.

Sorgente	LED COB
Potenza	15W / 28W / 42W
Driver incluso	On/Off
Driver disponibili	1-10V / DALI / Push
MacAdam	SDCM 3
CCT	3000 K / 4000 K
CRI	≥90
UGR	<19
Durata LED	50.000 h
Classe isolamento	II
IP	54
Materiale	Alluminio
Garanzia	5 anni





Off

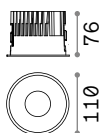

⌀ 50 mm
0,460 Kg/0,0021 m³

LED COB CITIZEN Driver TRIDONIC ON/OFF incluso

Potenza	Angolo	Lumen	CCT	Finitura	Codice	€
15 W	50°	1500 lm	3000 K	Bianco	266497	85,80
				Nero	266558	85,80
		1600 lm	4000 K	Bianco	266503	85,80
				Nero	266565	85,80

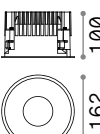

⌀ 150 mm
0,990 Kg/0,0045 m³

LED COB CITIZEN Driver TRIDONIC ON/OFF incluso

Potenza	Angolo	Lumen	CCT	Finitura	Codice	€
28 W	60°	3200 lm	3000 K	Bianco	266510	127,60
				Nero	266572	127,60
		3400 lm	4000 K	Bianco	266527	127,60
				Nero	266589	127,60



⌀ 195 mm
1,850 Kg/0,0094 m³

LED COB CITIZEN Driver TRIDONIC ON/OFF incluso

Potenza	Angolo	Lumen	CCT	Finitura	Codice	€
42 W	60°	4600 lm	3000 K	Bianco	266534	180,40
				Nero	266596	180,40
		4800 lm	4000 K	Bianco	266541	180,40
				Nero	266602	180,40



Modello	Necessario	Finitura	Codice	€
REFLECTOR Off 15W	No	Nero	266619	14,30
Off 28 W	No	Nero	266626	23,10
Off 42 W	No	Nero	266633	24,20

DIMMABLE DRIVER* Optional

Modello	Controllo	Potenza	Output	Misura (L x H x P)	Codice	€
Off 15 W	1-10V/Push	20 W	350 mA	105 x 20 x 50 mm	266657	66
	DALI	20 W	350 mA	105 x 20 x 50 mm	266701	66
Off 28 W	1-10V/Push	32 W	700 mA	100 x 20 x 65 mm	266671	93,50
	DALI	32 W	700 mA	100 x 20 x 65 mm	266725	93,50
Off 42 W	1-10V	42 W	1050 mA	120 x 20 x 75 mm	266688	110
	DALI/Push	45 W	1050 mA	150 x 43 x 30 mm	266732	110



Light beam: WIDE

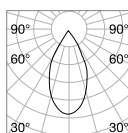

m	lx	øm
1	1688	0,93
2	422	1,90
3	188	2,80
4	105	3,70
5	68	4,60

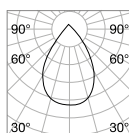

m	lx	øm
1	2457	1,30
2	614	2,50
3	273	3,80
4	154	5,10
5	98	6,40

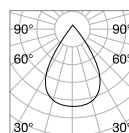
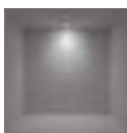

m	lx	øm
1	3496	1,20
2	874	2,40
3	388	3,60
4	218	4,80
5	140	6,00



CRI≥90 15W 50° 1100lm 3000K

CRI≥90 28W 60° 2300lm 3000K

CRI≥90 42W 60° 4600lm 3000K

* Gli alimentatori dimmerabili devono essere ordinati contestualmente al prodotto e verranno già inclusi all'interno degli apparecchi in sostituzione degli alimentatori on-off.



Deep

Sorgente	LED SMD	Durata LED	30.000 h
Potenza	10W/20W/30W	Classe isolamento	II
Driver incluso	On/Off	IP	20
Driver disponibili	1-10V/DALI/Push	Materiale	Alluminio
CCT	3000 K/4000 K	Garanzia	5 anni
CRI	≥80		



① 90 mm

0,160 Kg/0,0014 m³

LED SMD Driver ON/OFF incluso

Potenza	Angolo	Lumen	CCT	Finitura	Codice	€
10 W	70°	1200 lm	3000 K	Bianco	249018	27,50
		1250 lm	4000 K	Bianco	249025	27,50

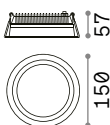

① 145 mm

0,360 Kg/0,0037 m³

LED SMD Driver ON/OFF incluso

Potenza	Angolo	Lumen	CCT	Finitura	Codice	€
20 W	77°	2100 lm	3000 K	Bianco	249032	60,50
		2150 lm	4000 K	Bianco	249049	60,50

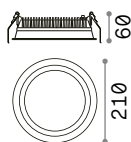

① 200 mm

0,650 Kg/0,0053 m³

LED SMD Driver ON/OFF incluso

Potenza	Angolo	Lumen	CCT	Finitura	Codice	€
30 W	77°	3200 lm	3000 K	Bianco	248783	82,50
		3250 lm	4000 K	Bianco	248790	82,50

DIMMABLE DRIVER* Optional

Modello	Controllo	Potenza	Output	Misura (LxHxP)	Codice	€
Deep 10 W	1-10V	10 W	300 mA	135 x 30 x 20 mm	248950	41,80
	DALI	12 W	300 mA	135 x 30 x 20 mm	248967	56,10
Deep 20 W	1-10V/Push	25 W	500 mA	167 x 41 x 32 mm	248974	68,20
	DALI/Push	25 W	500 mA	167 x 41 x 32 mm	248981	95,70
Deep 30 W	1-10V/Push	30 W	750 mA	167 x 41 x 32 mm	248998	78,10
	DALI/Push	36 W	700 mA	167 x 39 x 30 mm	249001	103,40



Light beam: WIDE

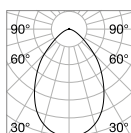

m	lx	øm
1	625	1,43
2	156	2,86
3	69	4,30
4	39	5,73
5	25	7,16

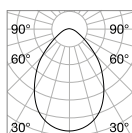

m	lx	øm
1	1056	1,60
2	264	3,20
3	117	4,81
4	66	6,41
5	42	8,01

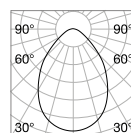

m	lx	øm
1	1644	1,60
2	411	3,20
3	183	4,81
4	103	6,41
5	66	8,01



CRI≥80 10W 70° 1200lm 3000K

CRI≥80 20W 77° 2100lm 3000K

CRI≥80 30W 77° 3200lm 3000K

* Gli alimentatori dimmerabili devono essere ordinati contestualmente al prodotto e verranno già inclusi all'interno degli apparecchi in sostituzione degli alimentatori on-off.



Basic

Faretto a incasso in alluminio pressofuso con ghiera rotonda, adatto per installazione su soffitti in cartongesso. Finitura bianca opaca; tecnologia COB Chip on Board e SMD. Disponibile in temperatura di colore 3000 K e 4000 K e con tre diverse ottiche; CRI ≥ 80 ; protezione frontale IP44 (a prodotto installato); classe isolamento II; durata utile LED 30.000 h L70B50.

IP44 Grado di protezione IP44.

Sorgente	LED COB / SMD
Potenza	10W / 15W / 20W / 30W
Driver incluso	On/Off
Driver disponibili	1-10V / DALI / Push
MacAdam	SDCM ≤ 4
CCT	3000 K / 4000 K
CRI	≥ 80
Durata LED	30.000 h
Classe isolamento	II
IP	44
Materiale	Alluminio
Garanzia	5 anni





Basic Accent

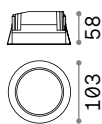

① 90 mm
0,400 Kg/0,0017 m³

LED COB PHILIPS Driver PHILIPS ON/OFF incluso

Potenza	Angolo	Lumen	CCT	Finitura	Codice	€
10 W	45°	1000 lm	3000 K	Bianco	193458	60,50
		1100 lm	4000 K	Bianco	193359	60,50

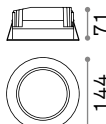

① 125 mm
0,660 Kg/0,0027 m³

LED COB PHILIPS Driver PHILIPS ON/OFF incluso

Potenza	Angolo	Lumen	CCT	Finitura	Codice	€
15 W	52°	1550 lm	3000 K	Bianco	193465	77
		1650 lm	4000 K	Bianco	193366	77
20 W		1900 lm	3000 K	Bianco	193472	82,50
		2100 lm	4000 K	Bianco	193373	82,50

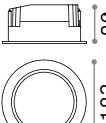

① 160 mm
1,250 Kg/0,0056 m³

LED COB PHILIPS Driver PHILIPS ON/OFF incluso

Potenza	Angolo	Lumen	CCT	Finitura	Codice	€
30 W	46°	2900 lm	3000 K	Bianco	193489	132
		3150 lm	4000 K	Bianco	193380	132

DIMMABLE DRIVER* Optional

Modello	Controllo	Potenza	Output	Misura (LxHxP)	Codice	€
Basic 10 W	1-10V	12 W	300 mA	150 x 43 x 29 mm	218823	30,80
	DALI/Push	10 W	300 mA	130 x 43 x 30 mm	220772	115,50
Basic 15 W	1-10V	15 W	450 mA	150 x 43 x 29 mm	218830	30,80
	DALI/Push	17 W	450 mA	130 x 43 x 30 mm	220796	121
Basic 20 W	DALI/Push	25 W	700 mA	130 x 43 x 30 mm	220789	132
Basic 30 W	1-10V	31 W	900 mA	150 x 43 x 29 mm	218854	41,80
	DALI/Push	45 W	900 mA	150 x 43 x 30 mm	220802	143



Light beam: ACCENT

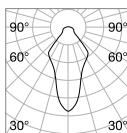

m	lx	øm
1	533	0,81
2	133	1,62
3	59	2,44
4	33	3,25
5	21	4,07

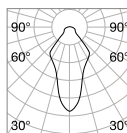
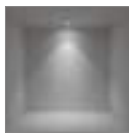

m	lx	øm
1	719	0,98
2	179	1,96
3	79	2,95
4	44	3,93
5	28	4,92

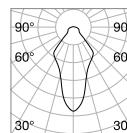

m	lx	øm
1	1250	0,92
2	312	1,84
3	138	2,76
4	78	3,69
5	50	4,61



CRI≥80 10W 45° 1000lm 3000K

CRI≥80 15W 52° 1550lm 3000K

CRI≥80 30W 46° 2900lm 3000K

* Gli alimentatori dimmerabili devono essere ordinati contestualmente al prodotto e verranno già inclusi all'interno degli apparecchi in sostituzione degli alimentatori on-off.



Basic Wide

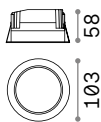

① 90 mm
0,370 Kg/0,0017 m³

LED SMD SAMSUNG Driver PHILIPS ON/OFF incluso

Potenza	Angolo	Lumen	CCT	Finitura	Codice	€
10 W	85°	1000 lm	3000 K	Bianco	193519	60,50
		1100 lm	4000 K	Bianco	193403	60,50

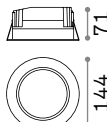

① 125 mm
0,630 Kg/0,0027 m³

LED SMD SAMSUNG Driver PHILIPS ON/OFF incluso

Potenza	Angolo	Lumen	CCT	Finitura	Codice	€
15 W	87°	1500 lm	3000 K	Bianco	193526	71,50
		1650 lm	4000 K	Bianco	193410	71,50
20 W		1900 lm	3000 K	Bianco	193533	77
		2100 lm	4000 K	Bianco	193427	77

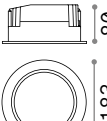

① 160 mm
1,130 Kg/0,0056 m³

LED SMD SAMSUNG Driver PHILIPS ON/OFF incluso

Potenza	Angolo	Lumen	CCT	Finitura	Codice	€
30 W	90°	2900 lm	3000 K	Bianco	193540	126,50
		3150 lm	4000 K	Bianco	193434	126,50

DIMMABLE DRIVER* Optional

Modello	Controllo	Potenza	Output	Misura (LxHxP)	Codice	€
Basic 10 W	1-10V	12 W	300 mA	150 x 43 x 29 mm	218823	30,80
	DALI/Push	10 W	300 mA	130 x 43 x 30 mm	220772	115,50
Basic 15 W	1-10V	15 W	450 mA	150 x 43 x 29 mm	218830	30,80
	DALI/Push	17 W	450 mA	130 x 43 x 30 mm	220796	121
Basic 20 W	DALI/Push	25 W	700 mA	130 x 43 x 30 mm	220789	132
Basic 30 W	1-10V	31 W	900 mA	150 x 43 x 29 mm	218854	41,80
	DALI/Push	45 W	900 mA	150 x 43 x 30 mm	220802	143



Light beam: **WIDE**

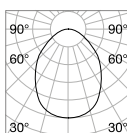

m	lx	øm
1	188	1,84
2	47	3,69
3	20	5,54
4	11	7,39
5	7	9,24

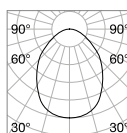
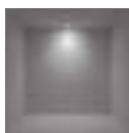

m	lx	øm
1	318	1,72
2	79	3,44
3	35	5,17
4	19	6,89
5	12	8,61

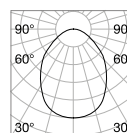

m	lx	øm
1	591	1,84
2	147	3,69
3	65	5,53
4	36	7,38
5	23	9,23



CRI≥80 10W 85° 1000lm 3000K

CRI≥80 15W 87° 1500lm 3000K

CRI≥80 30W 90° 2900lm 3000K

* Gli alimentatori dimmerabili devono essere ordinati contestualmente al prodotto e verranno già inclusi all'interno degli apparecchi in sostituzione degli alimentatori on-off.



Groove

IP20 CRI ≥80 30.000 h ALLUMINIO

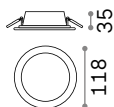

① 100 mm

0,220 Kg/0,0012 m³

LED SMD AND DRIVER Incluso

Potenza	Angolo	Lumen	CCT	Finitura	Codice	€
10 W	110°	890 lm	3000 K	Bianco	123974	23,10
		1000 lm	4000 K	Bianco	147666	23,10

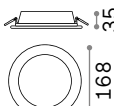

① 150 mm

0,410 Kg/0,0023 m³

LED SMD AND DRIVER Incluso

Potenza	Angolo	Lumen	CCT	Finitura	Codice	€
20 W	110°	1550 lm	3000 K	Bianco	123998	30,80
		1750 lm	4000 K	Bianco	147673	30,80

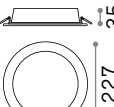

① 205 mm

0,660 Kg/0,0036 m³

LED SMD AND DRIVER Incluso

Potenza	Angolo	Lumen	CCT	Finitura	Codice	€
30 W	110°	2450 lm	3000 K	Bianco	124018	42,90
		2800 lm	4000 K	Bianco	147680	42,90

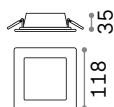

① 100 x 100 mm

0,270 Kg/0,0012 m³

LED SMD AND DRIVER Incluso

Potenza	Angolo	Lumen	CCT	Finitura	Codice	€
10 W	110°	890 lm	3000 K	Bianco	123981	24,20

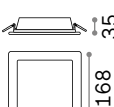

① 150 x 150 mm

0,540 Kg/0,0023 m³

LED SMD AND DRIVER Incluso

Potenza	Angolo	Lumen	CCT	Finitura	Codice	€
20 W	110°	1550 lm	3000 K	Bianco	124001	33

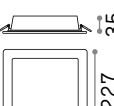

① 205 x 205 mm

0,850 Kg/0,0036 m³

LED SMD AND DRIVER Incluso

Potenza	Angolo	Lumen	CCT	Finitura	Codice	€
30 W	110°	2450 lm	3000 K	Bianco	124025	45,10



Light beam: WIDE





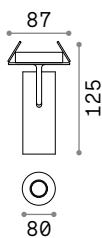

Play

☐ IP20 CRI ≥90 50.000 h ALLUMINIO



LED COB AND DRIVER Incluso

Potenza	Angolo	Lumen	CCT	Finitura	Codice	€
7 W	17°	520 lm	3000 K	Bianco	258270	66
				Nero	268088	66

 90°
  355°
  45 mm
 0,220 Kg/0,0014 m³



Light beam: SPOT



Channel

□ IP20 ALLUMINIO

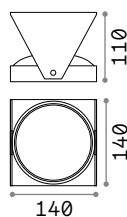

GU10 Lampadine LED GU10 13W 3000 K incluse. Cod. **189031**

Potenza	Finitura	Codice	€
max 13W	Nero	■ 203140	82,50

0,490 Kg/0,0037 m³

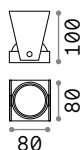

GU10 Lampadine LED GU10 5W 3000 K incluse. Cod. **108292**

Potenza	Finitura	Codice	€
max 7W	Nero	■ 203133	49,50

0,170 Kg/0,0017 m³

Nova

Sorgente	LED COB	Durata LED	30.000 h
Potenza	12W / 30W	Classe isolamento	II
Driver incluso	On/Off	IP	20
Driver disponibili	1-10V / DALI / Push	Materiale	Alluminio
CCT	3000 K / 4000 K	Garanzia	5 anni
CRI	≥90		

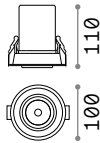

90° 360° 90 mm

 0,550 Kg/0,0016 m³

LED COB PHILIPS Driver ON/OFF incluso - UGR <19

Potenza	Angolo	Lumen	CCT	Finitura	Codice	€	
12 W	38°	1000 lm	3000 K	Bianco	248165	71,50	
				Nero	248189	71,50	
				4000 K	Bianco	267937	71,50
					Nero	267920	71,50

DIMMABLE DRIVER* Optional

	Potenza	Output	Misura (LxHxP)	Codice	€
1-10V / Push	15 W	300 mA	167 x 41 x 31 mm	243993	55
DALI	12 W	300 mA	135 x 30 x 20 mm	243986	49,50

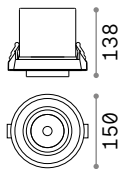

90° 360° 140 mm

 1,160 Kg/0,0039 m³

LED COB PHILIPS Driver ON/OFF incluso - UGR <22

Potenza	Angolo	Lumen	CCT	Finitura	Codice	€	
30 W	38°	3150 lm	3000 K	Bianco	248172	121	
				Nero	248196	121	
				4000 K	Bianco	267951	121
					Nero	267944	121

DIMMABLE DRIVER* Optional

	Potenza	Output	Misura (LxHxP)	Codice	€
1-10V / Push	36 W	750 mA	167 x 41 x 32 mm	248370	82,50
DALI / Push	36 W	700 mA	167 x 39 x 30 mm	248592	104,50



LENS

Modello	Necessario	Angolo	Codice	€
Nova 12W	No	15°	244013	5,50
Nova 30W	No	15°	248608	11



Light beam: ACCENT

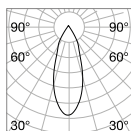

m	lx	cm
1	1768	0,66
2	442	1,32
3	196	1,97
4	111	2,63
5	71	3,29

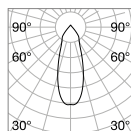

m	lx	cm
1	4671	0,64
2	1168	1,28
3	519	1,93
4	292	2,57
5	187	3,21



CRI≥90 12W 38° 1000lm 3000K

CRI≥90 30W 38° 3150lm 3000K

* Gli alimentatori dimmerabili devono essere ordinati contestualmente al prodotto e verranno già inclusi all'interno degli apparecchi in sostituzione degli alimentatori on-off.



Led Panel

Sorgente	LED SMD	UGR	<19
Potenza	38,5W	Durata LED	25.000 h
Driver incluso	On/Off	Classe isolamento	II
Driver disponibili	1-10V / DALI / Push	IP	20
MacAdam	SDCM ≤4	Materiale	Alluminio
CCT	3000 K / 4000 K	Garanzia	5 anni
CRI	≥80 / ≥90		



2,200 Kg/0,0144 m³
Q.tà d'acquisto 2 pezzi

LED SMD Driver ON/OFF incluso

CRI ≥80

Potenza	Angolo	Lumen	CCT	Finitura	Codice	€
38,5 W	81°	4150 lm	3000 K	Bianco	249711	44
		4450 lm	4000 K	Bianco	249728	44

CRI ≥90

Potenza	Angolo	Lumen	CCT	Finitura	Codice	€
38,5 W	81°	3550 lm	3000 K	Bianco	246390	44
		3800 lm	4000 K	Bianco	244181	44

DIMMABLE DRIVER* Optional

	Potenza	Output	Misura (L x H x P)	Codice	€
1-10V	42 W	1000 mA	125 x 83 x 26 mm	247854	33
DALI/Push	45 W	1000 mA	106 x 69 x 28 mm	247847	60,50



KIT PENDANT

KIT SURFACE

RECESSED FRAME**

Necessario	N° Cavi	Lunghezza cavi	Codice	€
No	4	1000 mm	244198	5,50
No			244204	5,50
No			267692	16,50



Light beam: WIDE

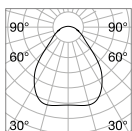

m	lx	Øm
1	1470	1,79
2	367	3,59
3	163	5,38
4	92	7,18
5	59	8,97

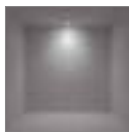

* Gli alimentatori dimmerabili devono essere ordinati contestualmente al prodotto e verranno già inclusi all'interno degli apparecchi in sostituzione degli alimentatori on-off.

**RECESSED FRAME  607 x 607 mm

CRI≥80 38,5W 81° 3800lm 3000K



Lika

Famiglia di moduli a incasso LED rettangolari in alluminio pressofuso verniciato nero o bianco, con riflettore in policarbonato nero lucido. Disponibili nelle versioni TRIM con cornice e TRIMLESS con bordo arretrato a scomparsa totale per installazione su soffitti in cartongesso. Moduli disponibili con due, cinque oppure dieci sorgenti luminose. Appositamente disegnato per evitare abbagliamenti (UGR<16), trova la sua migliore collocazione all'interno di UFFICI e spazi COMMERCIALI oppure in ambienti residenziali minimalisti. Sorgente luminosa a LED integrati; disponibile in temperatura di colore 3000 K e 4000 K; CRI ≥ 90; protezione IP20, classe isolamento II; durata utile LED 30.000 h L70B50.

UGR Articolo con UGR <16.

Sorgente	LED COB
Potenza	6W / 12,5W / 21W
Driver incluso	On/Off
Driver disponibili	DALI / Push
CCT	3000 K / 4000 K
CRI	≥90
UGR	<16
Durata LED	30.000 h
Classe isolamento	II
IP	20
Materiale	Alluminio
Garanzia	5 anni



P. 289





Lika Trim

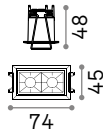

68 x 37 mm
0,130 Kg/0,0005 m³

LED COB OSRAM Driver ON/OFF incluso

Potenza	Angolo	Lumen	CCT	Finitura	Codice	€
6 W	29°	440 lm	3000 K	Nero	+ 206196	41,80
		500 lm	4000 K	Nero	+ 267869	41,80

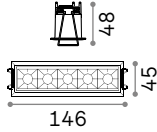

140 x 37 mm
0,240 Kg/0,0008 m³

LED COB OSRAM Driver ON/OFF incluso

Potenza	Angolo	Lumen	CCT	Finitura	Codice	€
12,5 W	29°	1100 lm	3000 K	Nero	+ 206219	63,80
		1250 lm	4000 K	Nero	+ 267876	63,80

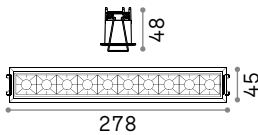

273 x 37 mm
0,480 Kg/0,0016 m³

LED COB OSRAM Driver ON/OFF incluso

Potenza	Angolo	Lumen	CCT	Finitura	Codice	€
21 W	29°	2200 lm	3000 K	Nero	+ 206233	116,60
		2500 lm	4000 K	Nero	+ 267883	116,60

DIMMABLE DRIVER* Optional

Modello	Controllo	Potenza	Output	Misura (LxHxP)	Codice	€
Lika 6 W	DALI	10 W	700 mA	135 x 30 x 20 mm	267982	56,10
Lika 12,5 W	DALI	12 W	700 mA	135 x 30 x 20 mm	267999	56,10
Lika 21 W	DALI/Push	25 W	600 mA	167 x 41 x 32 mm	268002	103,40



Light beam: ACCENT

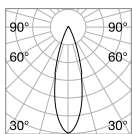

m	Ix	Øm
1	2091	0,58
2	523	1,16
3	232	1,74
4	131	2,32
5	70	2,90



CRI≥90 12,5W 29° 1100lm 3000K

* Gli alimentatori dimmerabili devono essere ordinati contestualmente al prodotto e verranno già inclusi all'interno degli apparecchi in sostituzione degli alimentatori on-off.



Lika Trimless

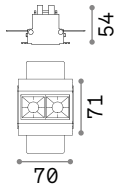

75 x 70 mm
0,220 Kg/0,0006 m³

LED COB OSRAM Driver ON/OFF incluso

Potenza	Angolo	Lumen	CCT	Finitura	Codice	€
6 W	29°	440 lm	3000 K	Nero	206202	57,20
		500 lm	4000 K	Nero	267890	57,20

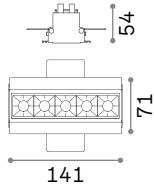

145 x 70 mm
0,390 Kg/0,0013 m³

LED COB OSRAM Driver ON/OFF incluso

Potenza	Angolo	Lumen	CCT	Finitura	Codice	€
12,5 W	29°	1100 lm	3000 K	Nero	206226	93,50
		1250 lm	4000 K	Nero	267906	93,50

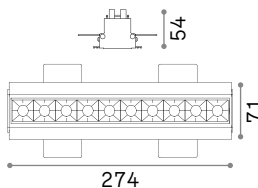

278 x 70 mm
0,720 Kg/0,0023 m³

LED COB OSRAM Driver ON/OFF incluso

Potenza	Angolo	Lumen	CCT	Finitura	Codice	€
21 W	29°	2200 lm	3000 K	Nero	206240	150,70
		2500 lm	4000 K	Nero	267913	150,70

DIMMABLE DRIVER* Optional

Modello	Controllo	Potenza	Output	Misura (LxHxP)	Codice	€
Lika 6 W	DALI	10 W	700 mA	135 x 30 x 20 mm	267982	56,10
Lika 12,5 W	DALI	12 W	700 mA	135 x 30 x 20 mm	267999	56,10
Lika 21 W	DALI/Push	25 W	600 mA	167 x 41 x 32 mm	268002	103,40



Light beam: ACCENT

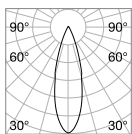

m	Ix	Øm
1	2786	0,58
2	696	1,16
3	309	1,74
4	174	2,32
5	111	2,90



CRI≥90 12,5W 29° 1100lm 3000K

* Gli alimentatori dimmerabili devono essere ordinati contestualmente al prodotto e verranno già inclusi all'interno degli apparecchi in sostituzione degli alimentatori on-off.





Eye

☐ IP20 CRI ≥ 80 30.000 h ALLUMINIO

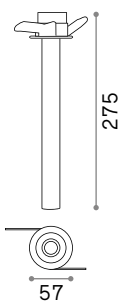

60° 360° 47 mm
0,260 Kg/0,0014 m³

LEDCOBANDDRIVER Incluso

Potenza	Angolo	Lumen	CCT	Finitura	Codice	€
2,5W	15°	270 lm	3000 K	Bianco	186986	82,50
				Nero	186993	82,50



Light beam: SPOT



Zephyr

IP20 GESSO

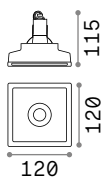

120 x 120 mm
0,880 Kg/0,0032 m³

GU10 Non inclusa - Lampadina consigliata 108292

Potenza	Finitura	Codice	€
max 35W	Bianco	150284	18,70

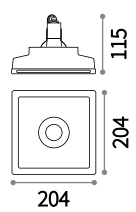

20° 110° 204 x 204 mm
1,350 Kg/0,0075 m³

GU10 Non inclusa - Lampadina consigliata 108292

Potenza	Finitura	Codice	€
max 35W	Bianco	155722	60,50

Samba

IP20 GESSO

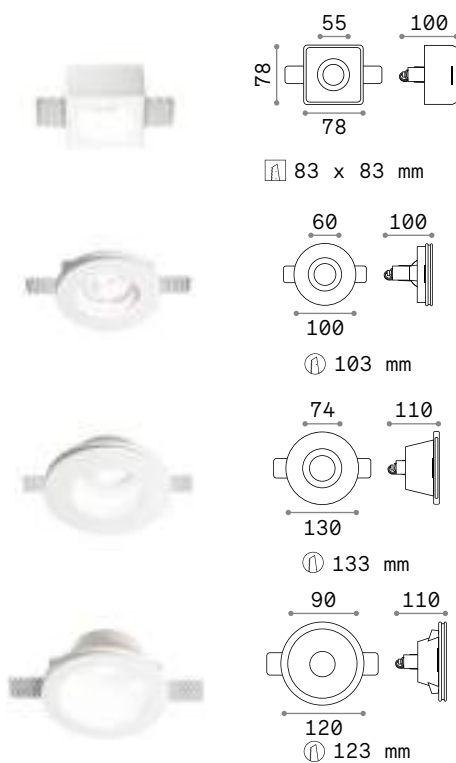

GU10 Non inclusa - Lampadina consigliata 108292

Potenza	Peso	Volume	Finitura	Codice	€
max 35W	0,360 Kg	0,0016 m ³	Bianco	230580	14,30

Potenza	Peso	Volume	Finitura	Codice	€
max 35W	0,230 Kg	0,0018 m ³	Bianco	150307	12,10

Potenza	Peso	Volume	Finitura	Codice	€
max 35W	0,450 Kg	0,0032 m ³	Bianco	150130	14,30

Potenza	Peso	Volume	Finitura	Codice	€
max 50W	0,340 Kg	0,0022 m ³	Bianco	139012	14,30

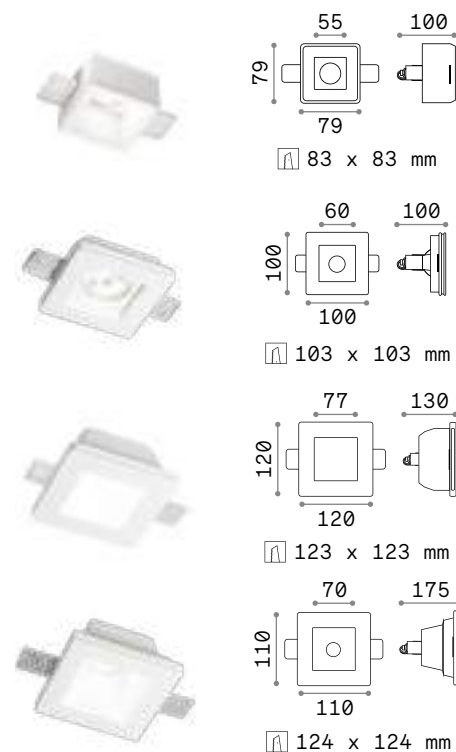

GU10 Non inclusa - Lampadina consigliata 108292

Potenza	Peso	Volume	Finitura	Codice	€
max 35W	0,330 Kg	0,0016 m ³	Bianco	229997	14,30

Potenza	Peso	Volume	Finitura	Codice	€
max 35W	0,320 Kg	0,0018 m ³	Bianco	150291	12,10

Potenza	Peso	Volume	Finitura	Codice	€
max 35W	0,600 Kg	0,0037 m ³	Bianco	150116	14,30

Diffusore in vetro

Potenza	Peso	Volume	Finitura	Codice	€
max 50W	0,430 Kg	0,0023 m ³	Bianco	139029	14,30



Jazz

IP20 ZINCO

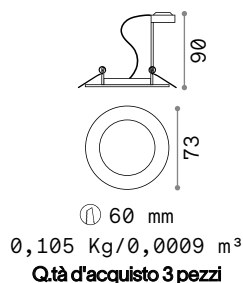

GU10 Non inclusa - Lampadina consigliata 108292

Potenza	Finitura	Codice	€
max 50W	Bianco	083117	9,90
	Brunito	083124	9,90
	Cromo	083070	9,90
	Nero	243818	9,90
	Nickel	083087	9,90

Swing

IP20 ZINCO

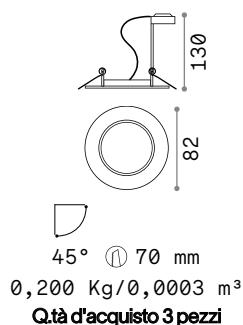

GU10 Non inclusa - Lampadina consigliata 108292

Potenza	Finitura	Codice	€
max 50W	Bianco	083179	12,10
	Brunito	083186	12,10
	Cromo	083131	12,10
	Nero	243825	12,10
	Nickel	083148	12,10

Lounge

IP20 ZINCO

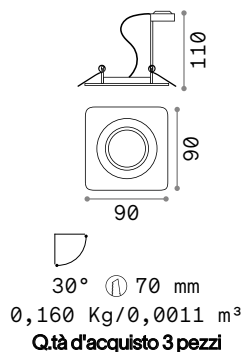

GU10 Non inclusa - Lampadina consigliata 108292

Potenza	Finitura	Codice	€
max 50W	Bianco	138978	16,50
	Cromo	138985	16,50
	Nero	244600	16,50

Funky

IP20 FERRO

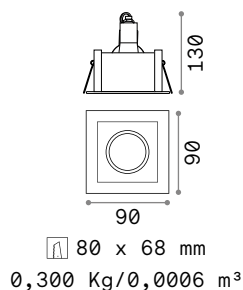

GU10 Non inclusa - Lampadina consigliata 108292

Potenza	Finitura	Codice	€
max 50W	Alluminio	083223	17,60
	Bianco	083230	17,60
	Brunito	083247	17,60
	Cromo	083193	17,60
	Nero	243849	17,60



Room-65

IP65 CRI ≥80 50.000 h ALLUMINIO

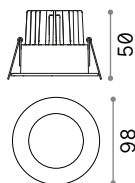

① 68 mm

0,220 Kg/0,0008 m³

LED COB Driver ON/OFF incluso

Potenza	Angolo	Lumen	CCT	Finitura	Codice	€
8 W	38°	800 lm	3000 K	Bianco	252025	77
				Nero	252032	77

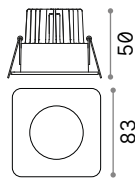

① 68 mm

0,240 Kg/0,0008 m³

LED COB Driver ON/OFF incluso

Potenza	Angolo	Lumen	CCT	Finitura	Codice	€
8 W	38°	800 lm	3000 K	Bianco	252049	77
				Nero	252056	77



Light beam: ACCENT



Blues

IP20 VETRO

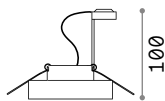

Ⓜ 60 mm

0,330 Kg/0,0012 m³

Q.tà d'acquisto 3 pezzi

GU10 Non inclusa - Lampadina consigliata 108292

Potenza	Finitura		Codice	€
max 50W	Trasparente		083254	23,10
	Bianco		113999	23,10
	Fumè		113982	23,10

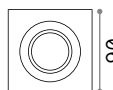
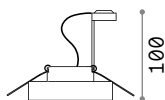

Ⓜ 60 mm

0,340 Kg/0,0012 m³

Q.tà d'acquisto 3 pezzi

GU10 Non inclusa - Lampadina consigliata 108292

Potenza	Finitura		Codice	€
max 50W	Trasparente		114019	23,10



Soul

IP20 CRISTALLO

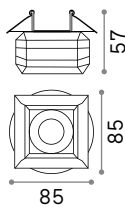

① 55 mm

0,340 Kg/0,0009 m³

G9 Non inclusa - Lampadina consigliata 209043

Potenza	Finitura	Codice	€
max 40W	Trasparente	107691	19,80

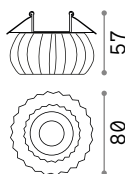

① 55 mm

0,400 Kg/0,0008 m³

G9 Non inclusa - Lampadina consigliata 209043

Potenza	Finitura	Codice	€
max 40W	Trasparente	107707	19,80



Polka

□ △ IP20

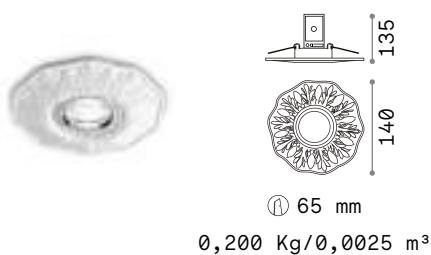

GU10 Non inclusa - Lampadina consigliata 108292

Potenza	Materiale	Finitura	Codice	€
max 50W	Gesso	Bianco	115597	15,40
	Alluminio	Ottone	115610	15,40
	Alluminio	Brunito	115580	15,40



115597



115610



115580



Walky

IP20 CRI ≥90 50.000 h GESSO

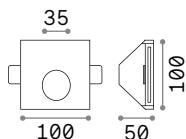

100 x 100mm
0,580 Kg/0,0009 m³

LED SMD AND DRIVER Incluso

Potenza	Lumen	CCT	Finitura	Codice	€
1W	55 lm	3000 K	Bianco	249834	62,70

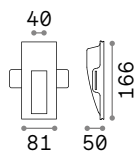

81 x 166 mm
0,580 Kg/0,0012 m³

LED SMD AND DRIVER Incluso

Potenza	Lumen	CCT	Finitura	Codice	€
1W	55 lm	3000 K	Bianco	249827	62,70

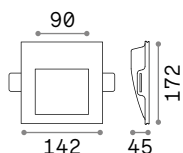

142 x 172 mm
0,980 Kg/0,0023 m³

LED SMD AND DRIVER Incluso

Potenza	Lumen	CCT	Finitura	Codice	€
1W	55 lm	3000 K	Bianco	249810	62,70



Light beam: ASYMMETRICAL



Esterni

Sospensioni e soffitto

Indice alfabetico

Bubble	692
Clio	686
Fiesta	693
Gun	689
Livia	689
Luna	685
Mib	692
Sole	684
Sunglasses	690
Techo	688
Urano	691
Xeno	690

Indice icone



Sole 684



Luna 685



Clio 686



Clio 686



Clio 686



Clio 686



Clio 686



Clio 686



Techo 688



Gun 689



Livia 689



Sunglasses 690



Xeno 690



Urano 691



Bubble 692



Mib 692



Fiesta 693



Sole

Diffusore in materiale plastico opale. Base sospensione in alluminio. Cavo elettrico in PVC.

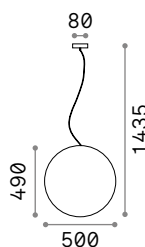

2,970 Kg / 0,1327 m³
E27 max 1x60W

€ 217,80

136011 Bianco

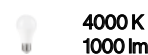

151991 € 2,75

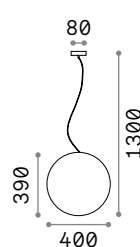

1,690 Kg / 0,0776 m³
E27 max 1x60W

€ 140,80

136004 Bianco

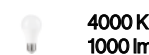

151991 € 2,75

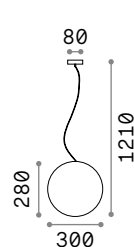

1,360 Kg / 0,0338 m³
E27 max 1x60W

€ 107,80

135991 Bianco



151991 € 2,75



P. 743



Luna

Montatura in alluminio pressofuso e tornito rifinito con vernici a polveri. Diffusore in materiale plastico opale.

LED Lampadine LED G9 3W 4000 K incluse nel modello **213200**. Cod. **209036**

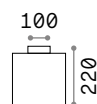

1,470 Kg / 0,0120 m³
E27 max 1x42W

€ 132

213194 Bianco



0,400 Kg / 0,0021 m³
G9 max 1x5W

€ 114,40

213200 Bianco



151991 € 2,75

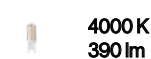

209036 € 4,29



P. 744

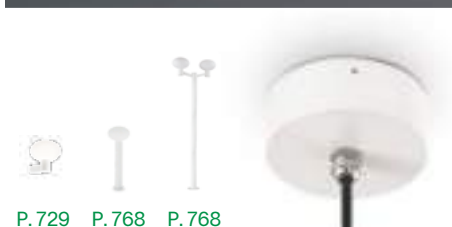

P. 729 P. 768 P. 768

Clio

Articolo componibile con montatura in alluminio estruso e tornito, rifinito con vernici a polveri di colore antracite, bianco, grigio e nero. Diffusore in materiale plastico bianco opaco.

116716



145068



145020



144252



144238



136073



144245

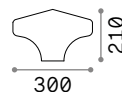
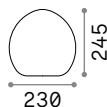
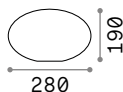
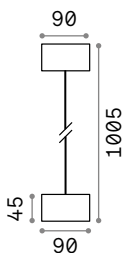

0,200 Kg / 0,0014 m³
E27 max 1x60W

€ 51,70

148847 ■ Bianco
148854 ■ Grigio
148861 ■ Antracite
148878 ■ Nero

0,580 Kg / 0,0019 m³
E27 max 1x60W

€ 70,40

144252 ■ Bianco
144238 ■ Grigio
136073 ■ Antracite
144245 ■ Nero

0,540 Kg / 0,0171 m³

€ 33

145068 ■ Bianco

0,520 Kg / 0,0144 m³

€ 33

116716 ■ Bianco

0,610 Kg / 0,0231 m³

€ 33

145020 ■ Bianco

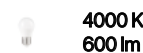

151960 € 2,75

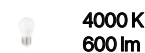

151960 € 2,75



Techo

Corpo luce in alluminio pressofuso verniciato a polveri. Diffusore in vetro temperato trasparente smerigliato. Disponibile nelle finiture antracite, bianco, coffee o nero.



251561



251554



251578



251592



1,700 Kg / 0,0049 m³
GU10 max 1x20W

€ 110

- 251523 ■ Bianco
- 251516 ■ Antracite
- 251530 ■ Nero
- 251547 ■ Coffee

4000 K
1000 lm

253398 € 16,50



0,600 Kg / 0,0012 m³
GU10 max 1x20W

€ 61,60

- 251561 ■ Bianco
- 251554 ■ Antracite
- 251578 ■ Nero
- 251592 ■ Coffee

4000 K
500 lm

253497 € 4,95

Gun

Corpo luce in alluminio con finitura naturale spazzolata o in vernice con varie finiture. Diffusore in vetro pirex trasparente.



0,490 Kg / 0,0030 m³
GU10 max 1x28W

€ 51,70

122663 Bianco
092324 Alluminio
163642 Grigio
236865 Antracite
122687 Nero
163666 Coffee

4000 K
500 lm

253497 € 4,95

P. 712



122663 092324 163642 236865 122687 163666

Livia

Corpo luce e diffusore in resina ad alte prestazioni: anti corrosione, anti U.V., da -60°a +90° C. Colori: bianco o nero.

Lampadine LED G9/GU10/GX53
3000 K incluse.



0,430 Kg / 0,0043 m³
GX53 max 1x10W

€ 79,20

269771 Bianco
261508 Nero

3000 K
910 lm

123936 € 7,15



0,350 Kg / 0,0027 m³
GU10 max 1x6W

€ 58,30

269757 Bianco
269764 Nero

3000 K
480 lm

108292 € 4,95



0,550 Kg / 0,0005 m³
G9 max 1x1,7W

€ 36,30

261522 Bianco
269740 Nero

3000 K
150 lm

270104 € 9,79



261522

269740

Sunglasses

Corpo luce in alluminio verniciato a polveri di colore antracite o bianco. Diffusori inclinabili con schermi in vetro trasparente.

LED Sorgente luminosa LED 4000 K, 25.000 h di durata.

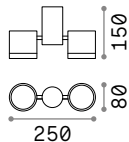

■ □ IP44

1,040 Kg / 0,0040 m³

LED 14W / 920 lm

€ 119,90

161853 ■ Bianco

161846 ■ Antracite



161853

161846

Xeno

Corpo luce in alluminio rifinito con vernice opaca a polveri. Diffusori orientabili con vetro temperato trasparente. Disponibile nelle finiture bianco, grigio o nero.

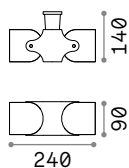

■ □ IP44

0,830 Kg / 0,0044 m³

GU10 max 2 x 28W

€ 69,30

129495 ■ Bianco

129518 ■ Grigio

129501 ■ Nero

4000 K
500 lm



253497

€ 4,95

P. 703



129495

129518

129501



Urano

Corpo luce in alluminio tornito verniciato a polveri con finitura opaca antracite o bianca. Diffusore in materiale acrilico trasparente e satinato.



168050



168135

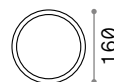
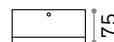

1,200 Kg / 0,0029 m³
GX53 max 1x15W

€ 88

168050 ■ Bianco
168135 ■ Antracite

4000 K
1000 lm

154008 € 7,15

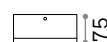

0,630 Kg / 0,0016 m³
GX53 max 1x15W

€ 62,70

168036 ■ Bianco
168111 ■ Antracite

4000 K
1000 lm

154008 € 7,15

Bubble

Montatura in alluminio pressofuso e tornito rifinito con vernici a polveri. Diffusore in materiale plastico bianco opaco.



1,730 Kg / 0,0249 m³

E27 max 1x 60W

€ 121

135250 Bianco

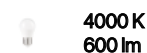

151960

€ 2,75

P. 728



Mib

Base in alluminio verniciato a polveri di colore bianco. Diffusore in materiale plastico opale. Sorgente luminosa a led integrati.

LED Sorgente luminosa LED 3000/4000 K, 36.000 h di durata.

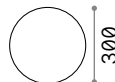

1,620 Kg / 0,0086 m³

LED 20W / 1650 lm

€ 195,80

269115 Bianco 3000K

202945 Bianco 4000K

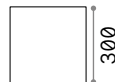

1,820 Kg / 0,0086 m³

LED 20W / 1650 lm

€ 195,80

269122 Bianco 3000K

202921 Bianco 4000K





Fiesta

Cavo con portalampane e occhielli di ancoraggio in materiale plastico bianco o nero. Fornito con spina per esterni.

159836



218724

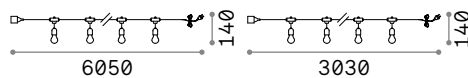

IP44

IP44

1,530 Kg / 0,0068 m³
E27 max 10 x 15W

0,600 Kg / 0,0049 m³
E27 max 5 x 15W

€ 107,80

€ 69,30

246802 ■ Bianco
246796 ■ Nero

218724 ■ Bianco
159836 ■ Nero

3000 K
340 lm
101286 € 3,30

3000 K
340 lm
101286 € 3,30



Esterni

Lampade da parete



Indice alfabetico

Andromeda	721	Terra	702
Anna	731	Tetris-1	718
Apollo	711	Tetris-2	719
Argo	719	Tommy	701
Base	714	Tronco	706
Bubble	728	Twin	720
Cima	730	Up	716
Clio	729	Xeno	703
Cometa	732		
Down	733		
Etere	707		
Febe	733		
Flood	704		
Francy	723		
Gas	702		
Giove	722		
Gun	712		
Iko	715		
Keope	710		
Lucia	726		
Maddi	727		
Minitommy	700		
Omega Round	698		
Omega Square	699		
Rex-1	724		
Rex-2	725		
Rex-3	725		
Rubik	717		
Snif Round	708		
Snif Square	709		
Style	705		











































Etere

Pag 707



Esterni

Indice icone

<small>new</small>	<small>new</small>					
						
Omega R. 698	Omega S. 699	Minitommy 700	Tommy 701	Terra 702	Gas 702	Xeno 703
						
Flood 704	Style 705	Tronco 706	Etere 707	Snif R. 708	Snif S. 709	Keope 710
						
Apollo 711	Gun 712	Base 714	Iko 715	Up 716	Rubik 717	Tetris-1 718
						
Tetris-2 719	Argo 719	Twin 720	Andromeda 721	Giove 722	Francy 723	Rex-1 724
						
Rex-2 725	Rex-3 725	Lucia 726	Maddi 727	Bubble 728	Clio 729	Clio 729
						
Clio 729	Cima 730	Anna 731	Cometa 732	Down 733	Febe 733	



Omega Round ^{new}

Corpo luce in alluminio verniciato a polveri. Diffusore inclinabile con schermo in vetro. Disponibile nelle finiture antracite, bianco, coffee o nero.

LED Sorgente luminosa LED 3000/4000 K, 25.000 h di durata.



285474



285450



285504



285498

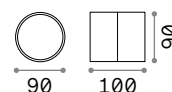

0,500 Kg / 0,0012 m³
LED 7W / 610/650 lm

€ 86,90

285474	Bianco	3000K	^{new}
285481	Bianco	4000K	^{new}
285450	Antracite	3000K	^{new}
285467	Antracite	4000K	^{new}
285504	Nero	4000K	^{new}
285498	Coffee	4000K	^{new}



Omega Square ^{new}

Corpo luce in alluminio verniciato a polveri. Diffusore inclinabile con schermo in vetro. Disponibile nelle finiture antracite, bianco o nero.

LED Sorgente luminosa LED 4000 K, 25.000 h di durata.



285528



285511



285535

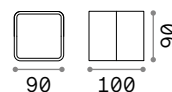

0,600 Kg / 0,0012 m³
LED 7W / 650 lm

€ 86,90

285528 Bianco ^{new}
285511 Antracite ^{new}
285535 Nero ^{new}



Minitommy

Corpo luce e diffusore in resina ad alte prestazioni: inattaccabile dalla corrosione sia di agenti atmosferici che di fertilizzanti chimici, colori stabilizzati da trattamento U.V., resistente a sbalzi termici da -60° C a + 90° C. Diffusore direzionabile.

LED Lampadine LED GU10 3,5W
3000/4000 K incluse.



096483

096476

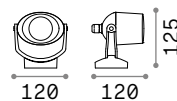

0,500 Kg / 0,0027 m³
GU10 max 1x6W

€ 81,40

096483 ■ 4000K Bianco
247182 ■ 3000K Nero
096476 ■ 4000K Nero

108292 3000K € 4,95
253497 4000K € 4,95



P. 778



Tommy

Corpo luce e diffusore in resina ad alte prestazioni: inattaccabile dalla corrosione sia di agenti atmosferici che di fertilizzanti chimici, colori stabilizzati da trattamento U.V., resistente a sbalzi termici da -60° C a + 90° C. Diffusore direzionabile.

LED Lampadine LED GX53 7W
3000/4000 K incluse.



145303



145327



145341

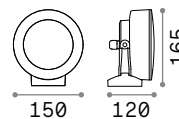

IP66

0,690 Kg / 0,0044 m³
GX53 max 1x 10W

€ 89,10

145303 ■ 4000K Bianco
145327 ■ 4000K Grigio
247168 ■ 3000K Nero
145341 ■ 4000K Nero

123936 3000K € 7,15
154008 4000K € 7,15



P. 779

Terra

Montatura in fusione d'alluminio verniciata. Corpo luce posizionabile. Diffusore in vetro pirex trasparente.

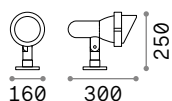

160

300

250

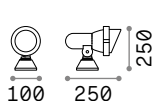

100

250

250

■ IP65

■ IP65

1,140 Kg / 0,0091 m³

E27 max 1x 60W

0,530 Kg / 0,0024 m³

GU10 max 1x 35W

€ 88

€ 49,50

046167 ■ Antracite

046181 ■ Antracite



4000 K
600 lm

151960

€ 2,75



4000 K
500 lm

253497

€ 4,95



P. 780

Gas

Corpo luce in alluminio pressofuso verniciato a polveri. Diffusore in vetro temperato trasparente sabbato. Disponibile nelle finiture antracite, bianco, coffee o nero.

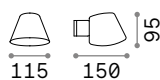

115

150

85

■ IP43

0,320 Kg / 0,0020 m³

GU10 max 1x 28W

€ 50,60

091518 ■ Bianco

091525 ■ Antracite

020228 ■ Nero

213095 ■ Coffee



4000 K
500 lm

253497

€ 4,95



P. 754



091518



091525



020228



213095



Xeno

Corpo luce in alluminio rifinito con vernice opaca a polveri. Diffusori orientabili con vetro temperato trasparente. Disponibile nelle finiture bianco, grigio o nero.



129488



129464



129471

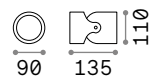

IP44

0,360 Kg / 0,0014 m³
GU10 max 1x28W

€ 35,20

129488 ■ Bianco
129471 ■ Grigio
129464 ■ Nero

4000 K
500 lm

253497 € 4,95



P. 690



Flood

Corpo luce orientabile in alluminio pressofuso verniciato a polveri. Diffusore in vetro temperato trasparente e zigrinato. Modello con sensore di movimento con regolazione di lux e tempo di accensione. Disponibile nei colori bianco o nero.

LED Sorgente luminosa LED 4000 K, 25.000 h di durata.

 Lampada con rilevazione di presenza inclusa PIR (Passive InfraRed).

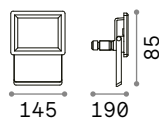

■  IP65

0,420 Kg / 0,0029 m³
LED 30W / 2700 lm

€ 31,90

269078 ■ Bianco
269061 ■ Nero

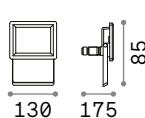

■  IP65

0,320 Kg / 0,0016 m³
LED 20W / 1850 lm

€ 22

251004 ■ Bianco
250991 ■ Nero

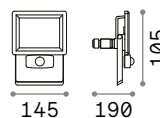

■  IP65 

0,440 Kg / 0,0029 m³
LED 30W / 2700 lm

€ 46,20

251028 ■ Bianco
251011 ■ Nero

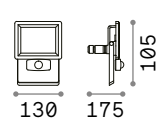

■  IP65 

0,360 Kg / 0,0027 m³
LED 20W / 1850 lm

€ 37,40

269108 ■ Bianco
269092 ■ Nero



Style

Corpo luce in alluminio verniciato a polveri. Diffusore in materiale plastico opale. Sorgente luminosa a led integrato. Modello AP Sensor dotato di sensore PIR. Disponibile nelle finiture antracite o bianco.

LED Sorgente luminosa LED
3000/4000 K, 30.000 h di durata.

Lampada con rilevazione di presenza
inclusa PIR (Passive InfraRed).

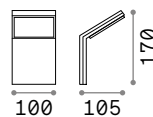

IP54

0,390 Kg / 0,0018 m³
LED 9W / 830 lm

€ 133,10

269139 3000K Bianco
221502 4000K Bianco
246857 3000K Antracite
209845 4000K Antracite

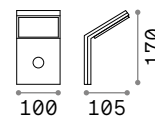

IP54

0,400 Kg / 0,0018 m³
LED 9,5W / 830 lm

€ 163,90

269146 3000K Bianco
209852 4000K Bianco
246864 3000K Antracite
221519 4000K Antracite



P. 749



Tronco

Corpo luce in alluminio pressofuso rifinito in vernice di colore antracite, bianco, grigio o nero. Diffusore in vetro pirex con elementi interni in alluminio.

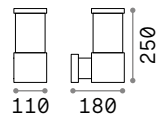

■ IP44

1,110 Kg / 0,0070 m³
E27 max 1x60W

€ 63,80

118659 Bianco
026978 Grigio
027005 Antracite
004716 Nero

4000 K
490 lm

153957 € 3,30



P. 758



Etere

Corpo luce in fusione di alluminio verniciato a polveri. Diffusore in materiale plastico color opale. Disponibile nelle finiture antracite o coffee.

LED Sorgente luminosa LED
3000/4000 K, 25.000 h di durata.

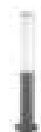

P. 762

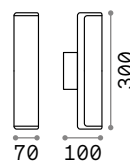

■ IP44

0,590 Kg / 0,0027 m³
LED 10,2W / 1020/1130 lm

€ 94,60

246925 ■ Antracite 3000K
172408 ■ Antracite 4000K
269153 ■ Coffee 3000K
246949 ■ Coffee 4000K



Snif Round

Corpo luce in alluminio pressofuso verniciato. Doppio diffusore, superiore e inferiore, in vetro pirex trasparente. Disponibile nelle finiture antracite, bianco, grigio o nero.

061467



144283



061474



061450

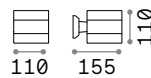

IP54

0,750 Kg / 0,0032 m³
G9 max 1x40W

€ 64,90

144283 ■ Bianco
061474 ■ Grigio
061467 ■ Antracite
061450 ■ Nero

4000 K
390 lm
209036 € 4,29



Snif Square

Corpo luce in alluminio pressofuso verniciato. Doppio diffusore, superiore e inferiore, in vetro pirex trasparente. Disponibile nelle finiture antracite, bianco, grigio o nero.

121963



144276



118666



123080

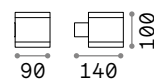

IP44

0,600 Kg / 0,0027 m³
G9 max 1x 40W

€ 55

144276 ■ Bianco
118666 ■ Grigio
121963 ■ Antracite
123080 ■ Nero

4000 K
390 lm

209036 € 4,29



Keope

Corpo luce e diffusore in resina ad alte prestazioni: inattaccabile dalla corrosione di agenti atmosferici; colori stabilizzati da trattamento U.V.. Resistente a sbalzi termici da -60° C a +90° C. Diffusori in materiale acrilico trasparente satinato.

LED Lampadine LED GU10 3,5W 4000 K incluse.



0,450 Kg / 0,0033 m³
GU10 max 2 x 6W

€ 62,70

147772 ■ Bianco
147796 ■ Grigio
147819 ■ Nero

108292  3000 K
480 lm

€ 4,95



0,350 Kg / 0,0033 m³
GU10 max 1 x 6W

€ 41,80

147765 ■ Bianco

108292  3000 K
480 lm

€ 4,95



Apollo

Corpo luce in alluminio pressofuso rifinito con vernice opaca a polveri in colore bianco o nero. Emissione luce sopra e sotto.

LED Sorgente luminosa LED 4000 K, 25.000 h di durata.



137407



137391



IP44

0,540 Kg / 0,0008 m³
LED 6W / 530 lm

€ 84,70

137407 ■ Bianco
137391 ■ Nero



Gun

Corpo luce in alluminio con finitura naturale spazzolata o in vernice con varie finiture. Diffusore in vetro pirex trasparente disponibile a luce singola o doppia, superiore e inferiore.



100388



033013



163628



236841



100395



163635

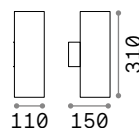

110 150 310



1,350 Kg / 0,0071 m³
E27 max 2 x 60W

€ 71,50

092300 ■ Bianco
033020 ■ Alluminio
163604 ■ Grigio
236858 ■ Antracite
092317 ■ Nero
163611 ■ Coffee

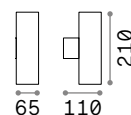

65 110 210



0,720 Kg / 0,0024 m³
GU10 max 2 x 35W

€ 62,70

100388 ■ Bianco
033013 ■ Alluminio
163628 ■ Grigio
236841 ■ Antracite
100395 ■ Nero
163635 ■ Coffee

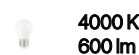

4000 K
600 lm
151960 € 2,75



4000 K
500 lm
253497 € 4,95



P. 689



Base

Corpo luce in alluminio pressofuso rifinito con vernice a polveri opaca di colore bianco, grigio o nero. Doppio diffusore, superiore e inferiore, in vetro temperato trasparente.



129457

129440

129433

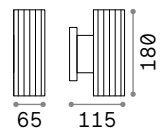

IP44

0,610 Kg / 0,0016 m³
GU10 max 2 x 28W

€ 39,60

129457 ■ Bianco
129440 ■ Grigio
129433 ■ Nero

4000 K
500 lm
253497 € 4,95



Iko

Corpo luce in alluminio pressofuso verniciato a polveri. Doppio diffusore, superiore e inferiore, in vetro temperato trasparente e sabbato. Disponibile nelle finiture antracite, bianco o grigio.

018515



092218



018522

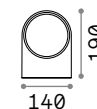
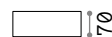

IP54

0,600 Kg / 0,0040 m³
E27 max 1x60W

€ 53,90

018522 ■ Bianco
092218 ■ Grigio
018515 ■ Antracite

4000 K
600 lm

151960 € 2,75



Up

Corpo luce in fusione di alluminio verniciato a polveri. Diffusori in vetro pirex trasparente. Disponibile nelle finiture antracite, bianco, coffee o nero.

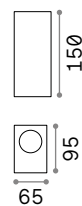

IP44

0,520 Kg / 0,0019 m³
G9 max 2x15W

€ 57,20

115320 ■ Bianco
115337 ■ Antracite
115344 ■ Nero
213354 ■ Coffee

4000 K
390 lm
209036 € 4,29

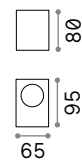

IP44

0,320 Kg / 0,0012 m³
G9 max 1x15W

€ 38,50

115290 ■ Bianco
115306 ■ Antracite
115313 ■ Nero
213347 ■ Coffee

4000 K
390 lm
209036 € 4,29



Rubik

Corpo luce in fusione di alluminio verniciato a polveri. Struttura interna che riflette il fascio luminoso sia sopra sia sotto. Disponibile nelle finiture antracite, bianco o nero.

LED Sorgente luminosa LED
3000/4000 K, 25.000 h di durata.



187358

187341

180045

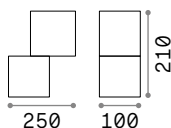

■ IP44

2,000 Kg / 0,0091 m³
LED 14W / 1150 lm

€ 202,40

187358 ■ Bianco 4000K
187341 ■ Antracite 4000K
180045 ■ Nero 4000K



■ IP44

0,660 Kg / 0,0022 m³
LED 9W / 630/670 lm

€ 132

269313 ■ Bianco 3000K
149745 ■ Bianco 4000K
247083 ■ Antracite 3000K
149738 ■ Antracite 4000K
269320 ■ Nero 3000K
142302 ■ Nero 4000K



■ IP54

0,340 Kg / 0,0008 m³
LED 4W / 260/280 lm

€ 75,90

254326 ■ Bianco 3000K
269214 ■ Bianco 4000K
269184 ■ Antracite 3000K
269207 ■ Antracite 4000K



Tetris-1

Corpo luce in alluminio rifinito con vernice opaca a polveri. Diffusore in vetro temperato trasparente. Disponibile nelle finiture antracite, bianco, coffee o grigio.

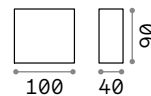

IP44

0,390 Kg / 0,0017 m³
G9 max 1x 15W

€ 81,40

114293 ■ Bianco
113760 ■ Grigio
113753 ■ Antracite
213323 ■ Coffee

4000 K
390 lm
209036 € 4,29

Tetris-2

Corpo luce in alluminio rifinito con vernice opaca a polveri di colore antracite o bianco. Diffusore in vetro temperato trasparente. Emissione luce sopra e sotto.

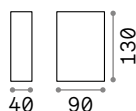

IP44

0,520 Kg / 0,0018 m³

G9 max 2 x 15W

€ 91,30

269221 ■ Bianco

113791 ■ Antracite

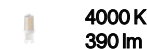

209036 € 4,29



Argo

Corpo luce in alluminio pressofuso verniciato a polveri. Diffusore in vetro temperato trasparente con riflettore interno bianco. Disponibile nelle finiture antracite o bianco.

LED Sorgente luminosa LED
3000/4000 K, 20.000 h di durata.

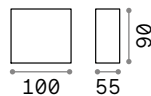

IP65

0,600 Kg / 0,0013 m³

LED 10W / 1200/1300 lm

€ 75,90

268309 ■ Bianco 3000K

268316 ■ Bianco 4000K

250946 ■ Antracite 3000K

268293 ■ Antracite 4000K





Twin



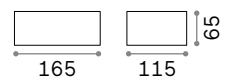

Corpo luce in alluminio pressofuso verniciato a polveri di colore antracite, bianco, coffee o nero. Doppio diffusore, superiore e inferiore, in vetro pirex trasparente satinato.



■  IP44

0,510 Kg / 0,0026 m³
G9 max 1x28W

€ 50,60

115351  Bianco
115368  Antracite
115375  Nero
213330  Coffee

 4000 K
390 lm
209036 € 4,29



Andromeda

Corpo luce in alluminio pressofuso verniciato. Doppio diffusore, superiore e inferiore, in vetro pirex satinato. Disponibile nelle finiture antracite, bianco, coffee, grigio o nero.

100364



163543



092355



100371



163550

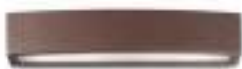

IP54

1,630 Kg / 0,0052 m³
E27 max 2x60W

€ 84,70

100364 Bianco
163543 Grigio
092355 Antracite
100371 Nero
163550 Coffee

4000 K
600 lm

151960 € 2,75

IP55

1,000 Kg / 0,0039 m³
E27 max 1x60W

€ 53,90

066868 Bianco
158822 Grigio
061580 Antracite
061597 Nero
163536 Coffee

4000 K
600 lm

151960 € 2,75



Giove

Corpo luce in alluminio pressofuso verniciato a polveri. Doppio diffusore, superiore e inferiore, in vetro temperato trasparente sabbato. Disponibile nelle finiture antracite, bianco, coffee o nero.



092195



092188



092201



163598

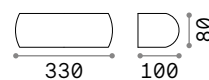

IP54

0,900 Kg / 0,0041 m³
E27 max 1x60W

€ 67,10

092195 ■ Bianco
092188 ■ Antracite
092201 ■ Nero
163598 ■ Coffee

4000 K
600 lm

151960 € 2,75



Francy

Corpo luce e diffusore in resina ad alte prestazioni: inattaccabile dalla corrosione sia di agenti atmosferici che di fertilizzanti chimici, colori stabilizzati da trattamento U.V., resistente a sbalzi termici da -60° C a + 90° C.



123776



123769



123783

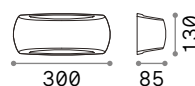

0,520 Kg / 0,0050 m³
E27 max 1x23W

€ 50,60

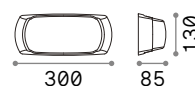

0,610 Kg / 0,0050 m³
E27 max 1x23W

€ 35,20

123745 ■ Bianco

123776 ■ Bianco

123769 ■ Grigio

123783 ■ Nero

4000 K
600 lm

151960 € 2,75

4000 K
600 lm

151960 € 2,75



Rex-1

Corpo luce in alluminio pressofuso verniciato a polveri di colore antracite, bianco o coffee. Diffusore bianco in materiale acrilico.

092393



092409



213217

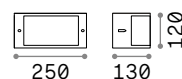

IP44

0,600 Kg / 0,0065 m³
E27 max 1x 60W

€ 40,70

092393 ■ Bianco
092409 ■ Antracite
213217 ■ Coffee

4000 K
1000 lm

151991 € 2,75

Rex-2

Corpo luce in alluminio pressofuso verniciato a polveri di colore antracite o bianco. Diffusore bianco in materiale acrilico.

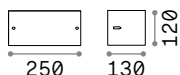

IP44

0,600 Kg / 0,0065 m³
E27 max 1x60W

€ 40,70

092416 ■ Bianco
092423 ■ Antracite

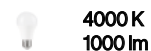

151991 € 2,75



Rex-3

Corpo luce in alluminio pressofuso verniciato a polveri di colore antracite o bianco. Diffusore bianco in materiale acrilico.

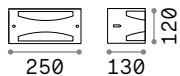

IP44

0,600 Kg / 0,0065 m³
E27 max 1x60W

€ 40,70

092430 ■ Bianco
092447 ■ Antracite

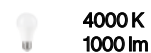

151991 € 2,75





Lucia

Corpo luce e diffusore in resina ad alte prestazioni: inattaccabile dalla corrosione sia di agenti atmosferici che di fertilizzanti chimici, colori stabilizzati da trattamento U.V., resistente a sbalzi termici da -60° C a +90° C.



096681



096698

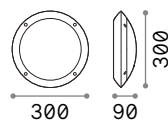

0,800 Kg / 0,0106 m³
E27 max 1x 23W

€ 30,80

096667 ■ Bianco
096674 ■ Nero

4000 K
1000 lm

151991 € 2,75

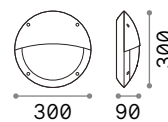

0,800 Kg / 0,0106 m³
E27 max 1x 23W

€ 22

096681 ■ Bianco
096698 ■ Nero

4000 K
1000 lm

151991 € 2,75



Maddi

Corpo luce e diffusore in resina ad alte prestazioni: inattaccabile dalla corrosione sia di agenti atmosferici che di fertilizzanti chimici, colori stabilizzati da trattamento U.V., resistente a sbalzi termici da -60°C a $+90^{\circ}\text{C}$.

096735



096728

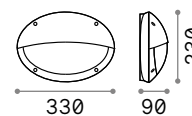
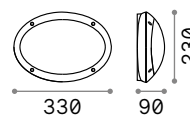

0,800 Kg / 0,0109 m³
E27 max 1x 23W

0,800 Kg / 0,0109 m³
E27 max 1x 23W

€ 23,10

€ 23,10

096711 ■ Bianco
096704 ■ Nero

096735 ■ Bianco
096728 ■ Nero

 4000 K
1000 lm
151991 € 2,75

 4000 K
1000 lm
151991 € 2,75



Bubble

Montatura in alluminio pressofuso e tornito rifinito con vernici a polveri. Diffusore in materiale plastico bianco opaco.

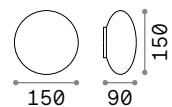

0,480 Kg / 0,0031 m³
G9 max 2x15W

€ 71,50

158907 Bianco

4000 K
390 lm

209036 € 4,29



P. 692



Clio

Articolo componibile con montatura in alluminio estruso e tornito, rifinito con vernici a polveri di colore antracite, bianco, grigio e nero. Diffusore in materiale plastico bianco opaco.

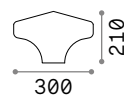
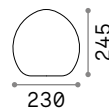
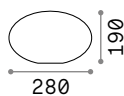
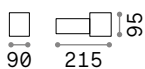

■ IP44

0,680 Kg / 0,0039 m³
E27 max 1x 60W

€ 70,40

146775 ■ Bianco
146782 ■ Grigio
145228 ■ Antracite
146799 ■ Nero

0,540 Kg / 0,0171 m³

€ 33

145068 ■ Bianco

0,520 Kg / 0,0144 m³

€ 33

116716 ■ Bianco

0,610 Kg / 0,0231 m³

€ 33

145020 ■ Bianco



P. 686



P. 686



P. 768



P. 768

4000 K
600 lm

151960 € 2,75



Cima

Corpo luce interamente in alluminio pressofuso. Con finitura antracite, coffee o nero e oro. Diffusore in acrilico trasparente.

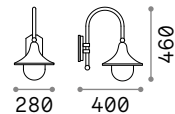

IP43

1,840 Kg / 0,0504 m³
E27 max 1x 60W

€ 60,50

246819 ■ Antracite
024134 ■ Nero Oro
246826 ■ Coffee

4000 K
980 lm

153964 € 7,70



P. 770



Anna

Corpo luce in resina ad alte prestazioni: inattaccabile dalla corrosione, colori stabilizzati da trattamento U.V., resistente a sbalzi termici da -60° C a +90° C. Diffusore in metacrilato antingiallimento.



120423



101491

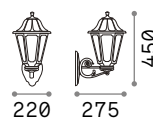

220 275 450

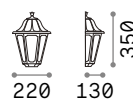

220 130 350



IP55



IP55

1,000 Kg / 0,0101 m³
E27 max 1x 23W

€ 30,80

0,600 Kg / 0,0117 m³
E27 max 1x 23W

€ 26,40

120423 ■ Bianco
101491 ■ Nero

120430 ■ Bianco
101552 ■ Nero

4000 K
980 lm

153964 € 7,70

4000 K
980 lm

153964 € 7,70



P. 771



Cometa

Corpo luce in alluminio pressofuso rifinito con vernice a polveri di colore antracite o nero. Diffusore in PVC bianco. È sconsigliato esporre l'articolo a contatto diretto con i raggi solari.



082240



082271

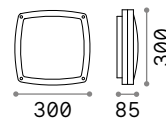

1,500 Kg / 0,0124 m³
E14 max 3x28W

€ 95,70

082240 ■ Antracite
082271 ■ Nero

3000 K
420 lm

101217 € 3,30

Down

Montatura in alluminio pressofuso verniciato a polveri con finitura antracite o bianca. Diffusore in acrilico.

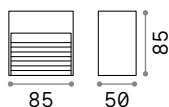

IP44

0,270 Kg / 0,0010 m³
G9 max 1x 28W

€ 29,70

115382 ■ Bianco
122045 ■ Antracite

4000 K
390 lm

209036 € 4,29



Febe

Apparecchio da installazione su superficie con corpo luce in alluminio pressofuso verniciato a polveri. Diffusore in vetro temperato trasparente. Disponibile nelle finiture antracite o bianco.

LED Sorgente luminosa LED 3000 K,
20.000 h di durata.

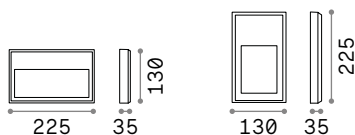

IP65

0,760 Kg / 0,0020 m³
LED 6W / 490 lm

€ 82,50

268347 ■ Bianco
250854 ■ Antracite

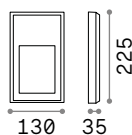

IP65

0,760 Kg / 0,0020 m³
LED 6W / 380 lm

€ 79,20

268361 ■ Bianco
268354 ■ Antracite





Esterni

Bollard e lampade da tavolo



Indice alfabetico

Acqua	755	Tronco	758
Agos	748	Vega	757
Amelia	760	Venus	761
Anna	771	Zenith	754
Cima	770		
Classic Globe	767		
Clio	768		
Doris	742		
Edo Outdoor	763		
Elisa	765		
Etere	762		
Gas	754		
Hub	747		
Itaca	746		
Jar	741		
Live	740		
Lolita	738		
Luna	744		
Marte	766		
Mercurio	766		
Path	753		
Pulsar	761		
Sasso	745		
Sirio	750		
Sole	743		
Stardust	739		
Style	749		
Tesla	752		
Tifone	756		
Titano	751		
Torre	764		

Path

Pag 753



new



Lolita 738



Stardust 739



Live 740



Itaca 746



Hub 747



Agos 748



Acqua 755



Tifone 756



Vega 757



Elisa 765



Marte 766



Mercurio 766



Live 740



Live 740



Jar 741



Doris 742



Sole 743



Luna 744



Sasso 745



Style 749



Sirio 750



Titano 751



Tesla 752

new



Path 753



Gas 754



Zenith 754



Tronco 758



Amelia 760

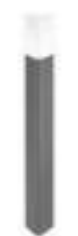

Pulsar 761



Venus 761



Etere 762



Edo Outdoor 763



Torre 764



Classic Globe 767



Clio 768



Clio 768



Clio 768



Cima 770



Anna 771



Lolita

Lampada da tavolo a batteria ricaricabile con finitura bianca, grigia, nera o coffee. Montatura in metallo. Diffusore in materiale plastico. Autonomia di 7,5 ore. Tempo di ricarica della batteria 7 ore.

LED Sorgente luminosa LED 3000 K, 25.000 h di durata.

ON OFF Lampada con interruttore integrato.

+ - Lampada con dimmer.

Hand icon Lampada con dimmer tattile.

Battery icon Lampada con batteria ricaricabile inclusa. Durata 7,5 ore.



250281

276489

250274

271576

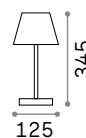

IP54

0,530 Kg / 0,0078 m³
LED 3,5W / 330 lm

€ 93,50

250281 **Bianco**
276489 **Grigio** *new*
250274 **Nero**
271576 **Coffee** *new*



Stardust

Lanterna portatile a batteria.
Montatura in alluminio pressofuso
verniciato a polveri con finitura
antracite con elementi in vetro nero
sulla parte superiore. Diffusore
in vetro temperato trasparente.
Emissione luce verso il basso.

LED Sorgente luminosa LED 3000 K,
20.000 h di durata.

ON/OFF Lampada con interruttore integrato.

+ Lampada con dimmer.

B Lampada con batteria ricaricabile
inclusa. Durata 7 ore.

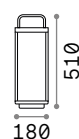

IP54

2,780 Kg / 0,0191 m³
LED 2W / 270 lm

€ 141,90

250885 ■ Antracite

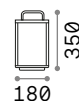

IP54

2,630 Kg / 0,0130 m³
LED 2W / 270 lm

€ 129,80

250878 ■ Antracite



138886



138893

Live

Apparecchio mobile senza cavi, con led alimentati da batterie ricaricabili e luce a variazione di colore regolabile RGB. Corpo luce-diffusore in policarbonato bianco opaco. Autonomia batterie di 10 ore.



Sorgente luminosa LED 4000 K, 15.000 h di durata.



Lampada con interruttore integrato.



Lampada con batteria ricaricabile inclusa. Durata 10 ore.

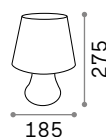

0,570 Kg / 0,0116 m³
LED 2,5W / 50 lm

€ 112,20

138886 Bianco

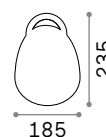

0,410 Kg / 0,0090 m³
LED 2,5W / 50 lm

€ 112,20

138893 Bianco



Jar

Corpo luce-diffusore in materiale plastico di colore bianco opaco.
Fornito completo di cavo e spina.

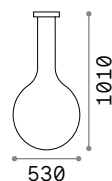

4,650 Kg / 0,2918 m³
E27 max 1x42W

€ 315,70

205946 Bianco

4000 K
1000 lm

151991 € 2,75



3,070 Kg / 0,1232 m³
E27 max 1x42W

€ 264

205939 Bianco

4000 K
1000 lm

151991 € 2,75



Doris

Diffusore in materiale plastico grigio melange effetto granito. Fornito con spina e picchetto per fissaggio nel terreno.

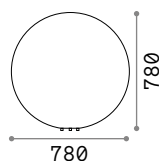

IP44

7,600 Kg / 0,5581 m³
E27 max 1x60W

€ 544,50

195506 Bianco

4000 K
1000 lm

151991 € 2,75

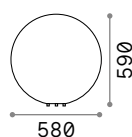

IP44

4,050 Kg / 0,2306 m³
E27 max 1x60W

€ 324,50

195490 Bianco

4000 K
1000 lm

151991 € 2,75

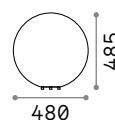

IP44

3,000 Kg / 0,1366 m³
E27 max 1x60W

€ 214,50

195483 Bianco

4000 K
1000 lm

151991 € 2,75

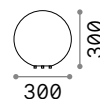

IP44

1,210 Kg / 0,0318 m³
E27 max 1x60W

€ 126,50

214009 Bianco

4000 K
1000 lm

151991 € 2,75



Sole

Diffusore in materiale plastico opale. Fornito con spina e picchetto per terreno. Base sospensione in alluminio.

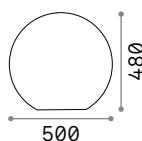

4,500 Kg / 0,1460 m³
E27 max 1x60W

€ 242

191614 Bianco

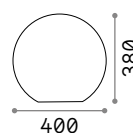

3,900 Kg / 0,0741 m³
E27 max 1x60W

€ 169,40

191621 Bianco

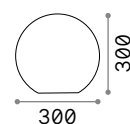

2,700 Kg / 0,0322 m³
E27 max 1x60W

€ 139,70

191638 Bianco



P. 684

4000 K
1000 lm
151991 € 2,75

4000 K
1000 lm
151991 € 2,75

4000 K
1000 lm
151991 € 2,75



Luna

Corpo luce diffusore in materiale plastico opale. Fornito con spina e picchetto per terreno.

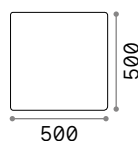

IP44

6,700 Kg / 0,1743 m³
E27 max 1x60W

€ 356,40

191607 Bianco

4000 K
1000 lm

151991 € 2,75

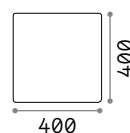

IP44

4,700 Kg / 0,1005 m³
E27 max 1x60W

€ 236,50

191584 Bianco

4000 K
1000 lm

151991 € 2,75

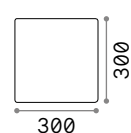

IP44

2,700 Kg / 0,0356 m³
E27 max 1x60W

€ 168,30

191577 Bianco

4000 K
1000 lm

151991 € 2,75



P. 685



Sasso

Diffusore in materiale plastico opale. Fornito di cavo con spina e picchetto per fissaggio a terra.

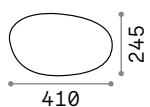

1,500 Kg / 0,0444 m³
E27 max 1x 40W

€ 202,40

161778 Bianco



151991 € 2,75

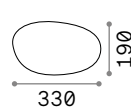

0,900 Kg / 0,0209 m³
E27 max 1x 40W

€ 146,30

161761 Bianco

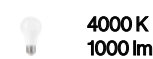

151991 € 2,75

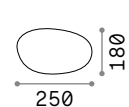

0,710 Kg / 0,0123 m³
G9 max 1x 15W

€ 105,60

161754 Bianco

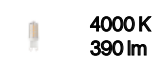

209036 € 4,29



Itaca

Base e stelo in metallo verniciato a polveri di colore bianco. Diffusore conico in materiale plastico color opale. Fornito con spina.

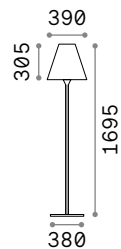

IP44

11,040 Kg / 0,1385 m³
E27 max 1x60W

€ 308

180953 Bianco

4000 K
1000 lm

151991 € 2,75



Hub

Base, asta e corpo luce in alluminio verniciato a polveri. Diffusore orientabile con schermo in vetro temperato trasparente. Fornito di picchetto per fissaggio a terra. Disponibile nelle finiture antracite o bianco.

LED Sorgente luminosa LED
3000/4000 K, 50.000 h di durata.



269245



251257

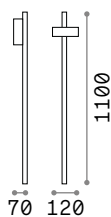

IP54

0,850 Kg / 0,0057 m³
LED 4,5W / 350/460 lm
€ 132

- | | | |
|--------|-----------|-------|
| 269245 | Bianco | 3000K |
| 269252 | Bianco | 4000K |
| 251257 | Antracite | 3000K |
| 269238 | Antracite | 4000K |

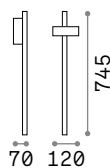

IP54

0,720 Kg / 0,0083 m³
LED 4,5W / 350/460 lm
€ 132

- | | | |
|--------|-----------|-------|
| 269269 | Bianco | 3000K |
| 269276 | Bianco | 4000K |
| 251226 | Antracite | 3000K |
| 271514 | Antracite | 4000K |



Base
Non incluso
Optional
€ 31,90

- | | |
|--------|-----------|
| 270845 | Bianco |
| 251295 | Antracite |



Agos

Corpo luce in alluminio pressofuso verniciato a polveri. Diffusore in acrilico trasparente satinato. Colore antracite.



Sorgente luminosa LED
3000/4000 K, 25.000 h di durata.

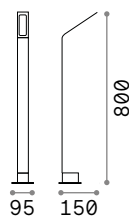

IP54

1,100 Kg / 0,0127 m³
LED 6,5W / 670/730 lm

€ 140,80

254319 ■ Antracite 3000K
268422 ■ Antracite 4000K

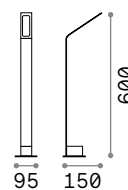

IP54

0,950 Kg / 0,0096 m³
LED 6,5W / 670/730 lm

€ 119,90

254388 ■ Antracite 3000K
268439 ■ Antracite 4000K



Style

Corpo luce in alluminio verniciato a polveri. Diffusore in materiale plastico opale. Sorgente luminosa a led integrato.

LED Sorgente luminosa LED
3000/4000 K, 30.000 h di durata.



 IP54

1,670 Kg / 0,0239 m³
LED 9W / 750/830 lm

€ 190,30

246871 ■ Antracite 3000K
209906 ■ Antracite 4000K



P. 705



Sirio

Corpo luce in alluminio verniciato a polveri. Diffusore in vetro pirex trasparente. Disponibile nelle finiture antracite, bianco, coffee, grigio o nero.



115085 246963 115061 115108 213262

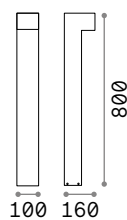

IP44

1,880 Kg / 0,0181 m³
G9 max 2x15W

€ 159,50

115085 Bianco
246963 Grigio
115061 Antracite
115108 Nero
213262 Coffee

4000 K
390 lm
209036 € 4,29

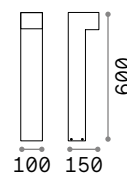

IP44

1,550 Kg / 0,0136 m³
G9 max 2x15W

€ 126,50

115092 Bianco
246970 Grigio
115078 Antracite
115115 Nero
213279 Coffee

4000 K
390 lm
209036 € 4,29



Titano

Corpoluce in resina porosa. Base e dettaglio diffusore in metallo verniciato nero opaco. Emissione luce verso il basso. LED integrato.

LED Sorgente luminosa LED
3000/4000 K, 50.000 h di durata.

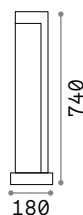

IP55

9,220 Kg / 0,0540 m³
LED 9W / 430/450 lm

€ 264

246987 ■ Granito 3000K
187327 ■ Granito 4000K

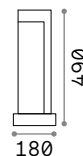

IP55

6,800 Kg / 0,0377 m³
LED 9W / 430/450 lm

€ 220

246994 ■ Granito 3000K
157856 ■ Granito 4000K



Tesla

Corpo luce in alluminio verniciato a polveri. Diffusore con schermo in materiale plastico bianco. Emissione luce verso il basso. Disponibile nelle finiture antracite o bianco.

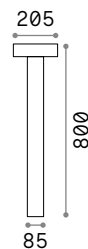

IP44

3,000 Kg / 0,0379 m³
G9 max 4 x 15W

€ 143

153179 ■ Bianco
153162 ■ Antracite

4000 K
390 lm
209036 € 4,29

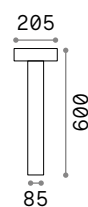

IP44

2,560 Kg / 0,0273 m³
G9 max 4 x 15W

€ 132

153209 ■ Bianco
153193 ■ Antracite

4000 K
390 lm
209036 € 4,29



Path ^{new}

Corpo luce in alluminio verniciato a polveri. Diffusore in policarbonato opale. Colore: antracite metallizzato.

LED

Sorgente luminosa LED
3000/4000 K, 20.000 h di durata.



285542-250816



285559-250823

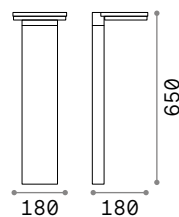

IP65

1,900 Kg / 0,0238 m³
LED 10W / 1200/1300 lm

€ 129,80

285542 ■ Antracite 3000K ^{new}
250816 ■ Antracite 4000K ^{new}

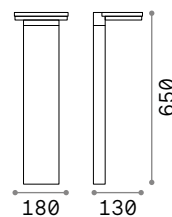

IP65

1,840 Kg / 0,0163 m³
LED 10W / 1200/1300

€ 129,80

285559 ■ Antracite 3000K ^{new}
250823 ■ Antracite 4000K ^{new}

Gas

Corpo luce in alluminio pressofuso verniciato a polveri. Diffusore in vetro temperato trasparente sabbiato. Disponibile nelle finiture antracite o coffee.

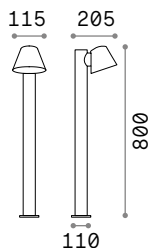

1,790 Kg / 0,0216 m³
GU10 max 1x35W

€ 115,50

139470 ■ Antracite
213101 ■ Coffee

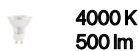

253497

€ 4,95

P. 702



Zenith

Montatura in fusione d'alluminio verniciata a polveri con finitura antracite. Corpo luce posizionabile. Diffusore in materiale plastico.



1,080 Kg / 0,0137 m³
GU10 max 1x11W

€ 115,50

124421 ■ Antracite

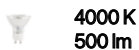

253497

€ 4,95

P. 781





Acqua

Corpo luce in alluminio tornito rifinito in vernice opaca con finitura antracite o coffee. Diffusore in vetro temperato.

135205



246918

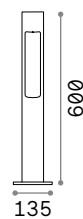

IP44

1,500 Kg / 0,0164 m³
G9 max 1x 15W

€ 159,50

135205 ■ Antracite
246918 ■ Coffee

4000 K
390 lm

209036 € 4,29



Tifone

Base e montatura in alluminio pressofuso verniciato a polveri con finitura antracite. Diffusore in vetro temperato trasparente. Emissione luce in basso.

LED Sorgente luminosa LED
3000 K, 20.000 h di durata.

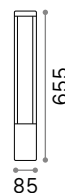

IP65

1,250 Kg / 0,0054 m³
LED 8,5W / 720 Lm

€ 121

250953 ■ Antracite

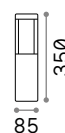

IP65

1,010 Kg / 0,0029 m³
LED 8,5W / 720 Lm

€ 104,50

250977 ■ Antracite



Vega

Corpo luce in alluminio con finitura in vernice opaca a polveri. Diffusore in vetro temperato trasparente. Disponibile nelle finiture antracite, bianco, coffee, grigio o nero.



136035

136042

136028

136059

213361

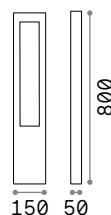

150 50

800

1,150 Kg / 0,0092 m³
G9 max 1x 15W

€ 178,20

136035 Bianco
136042 Grigio
136028 Antracite
136059 Nero
213361 Coffee

4000 K
390 lm
209036 € 4,29



Tronco

Corpo luce in alluminio pressofuso rifinito in vernice di colore antracite, bianco, coffee, grigio o nero. Diffusore in vetro pirex con elementi interni in alluminio.

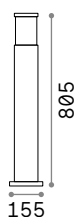

2,490 Kg / 0,0254 m³
E27 max 1x60W

€ 145,20

109138 Bianco
026961 Grigio
026992 Antracite
004723 Nero
163741 Coffee



4000 K
490 lm

153957 € 3,30

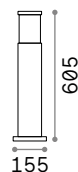

1,970 Kg / 0,0193 m³
E27 max 1x60W

€ 124,30

109145 Bianco
026954 Grigio
026985 Antracite
004730 Nero
163758 Coffee



4000 K
490 lm

153957 € 3,30

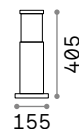

0,590 Kg / 0,0135 m³
E27 max 1x60W

€ 112,20

248264 Bianco
248288 Grigio
248257 Antracite
248295 Nero
248271 Coffee



4000 K
490 lm

153957 € 3,30



P. 706



Amelia

Corpo luce e diffusore in resina ad alte prestazioni: anti corrosione, colori stabilizzati da trattamento U.V., resistente da -60° C a + 90° C.



Lampadine LED E27 8W Goccia
4000 K incluse.

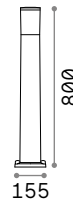

1,070 Kg / 0,0220 m³
E27 max 1x23W

€ 82,50

198644 ■ Bianco
198637 ■ Grigio
198620 ■ Nero

4000 K
1000 lm

151991 € 2,75

Pulsar

Montatura in fusione d'alluminio verniciato a polveri di colore antracite, coffee o grigio. Diffusore in policarbonato bianco.

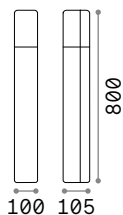

IP44

1,900 Kg / 0,0120 m³
E27 max 1x 42W

€ 187

135922 ■ Grigio
135908 ■ Antracite
246888 ■ Coffee

4000 K
600 lm

151960 € 2,75



Venus

Corpo luce in lamina d'acciaio disponibile con finitura spazzolata o antracite. Elemento diffusore superiore in acrilico satinato.

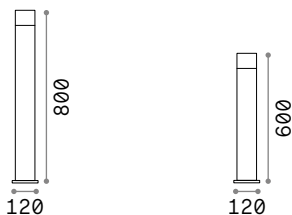

IP44

1,410 Kg / 0,0136 m³
GU10 max 1x 15W

€ 104,50

089775 ■ Acciaio
106175 ■ Antracite

4000 K
500 lm

253497 € 4,95



IP44

1,070 Kg / 0,0103 m³
GU10 max 1x 15W

€ 93,50

106182 ■ Antracite

4000 K
500 lm

253497 € 4,95





Etere

Corpo luce in fusione di alluminio verniciato a polveri. Diffusore in materiale plastico color opale. Disponibile nelle finiture antracite o coffee.

LED Sorgente luminosa LED 3000/4000 K, 25.000 h di durata.



P. 707

172439



246956

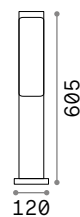

IP44

1,100 Kg / 0,0103 m³
LED 10,5W / 1020/1130 lm

€ 126,50

246932	Antracite	3000K
172439	Antracite	4000K
269160	Coffee	3000K
246956	Coffee	4000K



Edo Outdoor

Montatura in fusione d'alluminio verniciato a polveri di colore antracite, bianco o coffee. Diffusore in policarbonato bianco.



IP44

1,600 Kg / 0,0239 m³
GX53 max 1x15W

€ 132

135755 Bianco
138510 Antracite
213071 Coffee

4000 K
1000 lm

154008 € 7,15

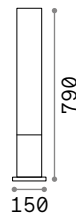

IP44

2,670 Kg / 0,0268 m³
GX53 max 1x15W

€ 132

142999 Bianco
135762 Antracite
213088 Coffee

4000 K
1000 lm

154008 € 7,15



Torre

Corpo luce in alluminio tornito verniciato a polveri con finitura antracite o nero. Diffusore in materiale plastico opale.

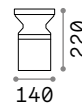
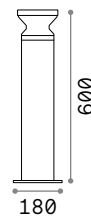

IP44

IP44

2,100 Kg / 0,0224 m³
E27 max 1x 15W

0,870 Kg / 0,0054 m³
E27 max 1x 15W

€ 139,70

€ 107,80

162492 ■ Antracite
186955 ■ Nero

158891 ■ Antracite
186979 ■ Nero

4000 K
600 lm

4000 K
600 lm

151960 € 2,75

151960 € 2,75



Elisa

Corpo luce in resina resistente a corrosione, UV, a temperature da -60° a +90° C. Diffusore trasparente anti ingiallimento.

LED Lampadine LED GX53 7W 4000 K incluse.



187877

187884

187891

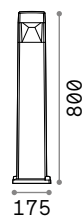

IP55

2,150 Kg / 0,0220 m³
GX53 max 1x 10W

€ 91,30

187877 ■ Bianco
187884 ■ Grigio
187891 ■ Nero

4000 K
1000 lm
154008 € 7,15

Marte

Corpo luce in alluminio verniciato a polveri con finitura antracite.
Diffusore bianco in materiale acrilico.



IP44

2,500 Kg / 0,0193 m³

E27 max 1x 25W

€ 160,60

092225 ■ Antracite

4000 K
1000 lm

151991 € 2,75



Mercurio

Corpo luce in alluminio verniciato a polveri con finitura antracite.
Diffusore in vetro pirex trasparente.

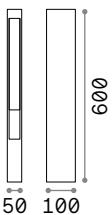

IP44

1,540 Kg / 0,0057 m³

G9 max 1x 15W

€ 160,60

114347 ■ Antracite

4000 K
390 lm

209036 € 4,29





Classic Globe

Corpo luce in resina resistente a corrosione, UV, a temperature da -60° a +90° C. Diffusore anti ingiallimento disponibile nelle finiture bianco o trasparente.



IP55

2,790 Kg / 0,1248 m³
E27 max 1x 23W

€ 121

187532 Trasparen.
187525 Bianco

 4000 K
1000 lm
151991 € 2,75

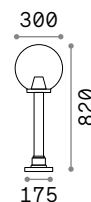

IP55

2,050 Kg / 0,1015 m³
E27 max 1x 23W

€ 100,10

187556 Trasparen.
187549 Bianco

 4000 K
1000 lm
151991 € 2,75

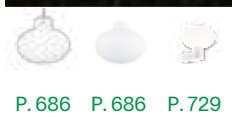

P. 686 P. 686 P. 729

Clio

Articolo componibile con montatura in alluminio estruso e tornito, rifinito con vernici a polveri di colore antracite, bianco, grigio e nero. Diffusore in materiale plastico bianco opaco.



249469

249476

249452

249483

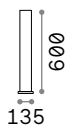

IP44

1,360 Kg / 0,0087 m³
E27 max 1x60W

€ 83,60

249469 ■ Bianco
249476 ■ Grigio
249452 ■ Antracite
249483 ■ Nero

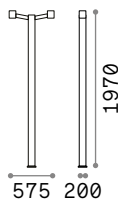

IP44

7,250 Kg / 0,0384 m³
E27 max 2x60W

€ 234,30

249506 ■ Bianco
249513 ■ Grigio
249490 ■ Antracite
249520 ■ Nero

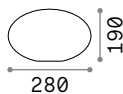

0,540 Kg / 0,0171 m³

€ 33

145068 ■ Bianco

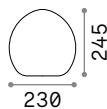

0,580 Kg / 0,0019 m³

€ 33

116716 ■ Bianco

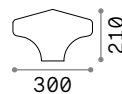

0,680 Kg / 0,0039 m³

€ 33

145020 ■ Bianco



4000 K
600 lm

151960 € 2,75



4000 K
600 lm

151960 € 2,75





Cima

Corpo luce interamente in alluminio pressofuso. Con finitura antracite, coffee o nero e oro. Diffusore in acrilico trasparente.



246833

024097

246840

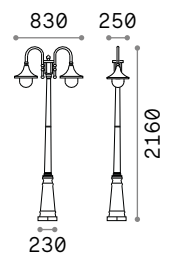

IP43

3,340 Kg / 0,1467 m³
E27 max 2 x 60W

€ 305,80

246833 ■ Antracite
024097 ■ Nero Oro
246840 ■ Coffee

4000 K
980 lm

153964 € 7,70



P. 730



Anna

Corpo luce in resina ad alte prestazioni: inattaccabile dalla corrosione, colori stabilizzati da trattamento U.V., resistente a sbalzi termici da -60° C a +90° C. Diffusore in metacrilato antingiallimento.



120454



101514

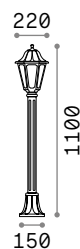

2,500 Kg / 0,0446 m³
E27 max 1x 23W

€ 84,70

120454 ■ Bianco
101514 ■ Nero

4000 K
980 lm

153964 € 7,70



P. 731



Esterni

Proiettori

Indice alfabetico

Alien	785
Inside	781
Krypton	784
Minitommy	778
Starlight	776
Terra	780
Thor	774
Tommy	779
Ulex	782
Zenith	781

Indice icone



Thor 774



Starlight 776



Minitommy 778



Tommy 779



Terra 780



Inside 781



Zenith 781



Ulex 782



Krypton 784



Alien 785

Thor

Proiettore lineare orientabile per installazione a superficie con effetto di luce radente. Corpo in alluminio pressofuso, diffusore in vetro trasparente. Sorgente luminosa a led integrato, disponibile in due lunghezze (500 mm e 1000 mm). Orientabilità +/-90° rispetto alla verticale, indice di protezione IP65, resistenza all'urto IK06, temperatura di colore 3000K, ingresso di alimentazione 24 Vdc; durata utile LED 50.000 h. Disponibile in opzione con visiera anti-abbagliamento.

Sorgente	LED SMD	Classe	III
Potenza	18W / 40W	isolamento	
Driver incluso	No	IP	65
Driver disponibili	On/Off	Materiale	Alluminio
CCT	3000 K		
CRI	≥80		
Durata LED	50.000 h		

PRO

Prodotto ad alto contenuto tecnologico, elevata qualità dei materiali, destinato ad uso professionale.

LED SMD OSRAM Driver non incluso

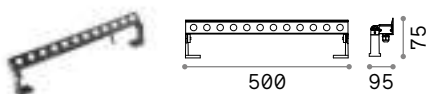

Potenza	Angolo	Lumen	CCT	Finitura	Codice	€
18W	30°	1950 lm	3000 K	Antracite	261331	212,30

1,490 Kg/0,0057 m³
Lunghezza cavo 500 mm

LED SMD OSRAM Driver non incluso

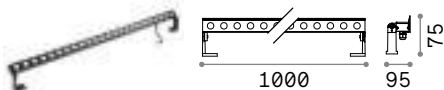

Potenza	Angolo	Lumen	CCT	Finitura	Codice	€
40W	30°	4850 lm	3000 K	Antracite	261355	333,30

2,460 Kg/0,0108 m³
Lunghezza cavo 500 mm

OPTIONAL Non incluso



		Finitura	Codice	€
Visiera	18W	Antracite	261362	18,70
	40W	Antracite	261379	30,80

ON/OFF DRIVER Non incluso/Necessario

Potenza	Output	Misura	Codice	€
40 W	24 Vdc	171 x 37 x 61 mm	272108	99
100 W	24 Vdc	220 x 68 x 39 mm	226200	170,50
185 W	24 Vdc	220 x 68 x 39 mm	226217	192,50



Starlight

Proiettore orientabile in alluminio con fissaggio a plafone o con picchetto; superficie anodizzata e verniciata a polveri in grigio scuro; LED integrato ad efficienza energetica con elevata resa cromatica; disponibile in temperatura di colore 3000K e 4000K; durata utile LED 50.000 h. Visiera antiabbagliamento in opzione.

Sorgente	LED COB	Classe	III
Potenza	5,5W / 10W	isolamento	
Driver incluso	No	IP	68
Driver disponibili	On/Off	Materiale	Alluminio
CCT	3000 K / 4000 K		
CRI	≥80		
Durata LED	50.000 h		

PRO

Prodotto ad alto contenuto tecnologico, elevata qualità dei materiali, destinato ad uso professionale.

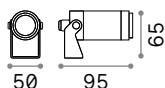

0,280 Kg/0,0005 m³

LED COB CITIZEN Driver non incluso

Potenza	Angolo	Lumen	CCT	Finitura	Codice	€
5,5 W	30°	700 lm	3000 K	Grigio Scuro	248394	115,50
		750 lm	4000 K	Grigio Scuro	245041	115,50

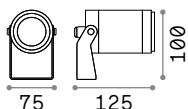

0,950 Kg/0,0014 m³

LED COB CITIZEN Driver non incluso

Potenza	Angolo	Lumen	CCT	Finitura	Codice	€
10 W	33°	1150 lm	3000 K	Grigio Scuro	248387	242
		1200 lm	4000 K	Grigio Scuro	245072	242

OPTIONAL Non incluso



	Potenza	Finitura	Codice	€
Visiera	5,5W	Grigio Scuro	245096	33
	10W	Grigio Scuro	245102	33
Connettore IP68		Nero	248615	22
Picchetto		Grigio Scuro	245089	16,50

ON/OFF DRIVER Non incluso/Necessario

Potenza	Output	Misura	Codice	€
20 W	24 Vdc	118 x 35 x 26 mm	226187	35
35 W	24 Vdc	148 x 40 x 30 mm	226194	45
100 W	24 Vdc	220 x 68 x 39 mm	226200	155
185 W	24 Vdc	220 x 68 x 39 mm	226217	175





Minitommy

Corpo luce e diffusore in resina ad alte prestazioni: inattaccabile dalla corrosione sia di agenti atmosferici che di fertilizzanti chimici, colori stabilizzati da trattamento U.V., resistente a sbalzi termici da -60° C a + 90° C. Diffusore direzionabile.

LED Lampadine LED GU10 3,5W
3000/4000 K incluse.

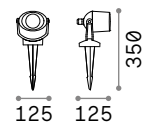

IP66

0,360 Kg / 0,0027 m³
GU10 max 1x6W

€ 81,40

120218 ■ 4000K Bianco
247199 ■ 3000K Nero
120201 ■ 4000K Nero

108292 3000K € 4,95
253497 4000K € 4,95



P. 700



Tommy

Corpo luce e diffusore in resina ad alte prestazioni: inattaccabile dalla corrosione sia di agenti atmosferici sia di fertilizzanti chimici; colori stabilizzati da trattamento U.V.. Resistente a sbalzi termici da -60° C a + 90° C. Diffusore direzionabile.

LED

Lampadine LED GX53 7W
3000/4000 K incluse.

145310

145334

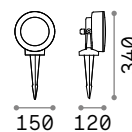
145358

0,730 Kg / 0,0044 m³
GX53 max 1x10W

€ 89,10

145310 4000K Bianco
145334 4000K Grigio
247175 3000K Nero
145358 4000K Nero

123936 3000K € 7,15
154008 4000K € 7,15



P. 701



Terra

Montatura in fusione d'alluminio verniciata. Corpo luce posizionabile. Diffusore in vetro pirex trasparente.



106205



033037



163727



046211

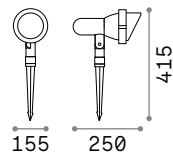

IP65

1,230 Kg / 0,0086 m³
E27 max 1x 60W

€ 89,10

033044 ■ Antracite

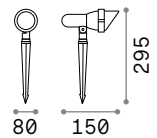

IP65

0,520 Kg / 0,0038 m³
GU10 max 1x 35W

€ 51,70

106205 ■ Bianco
033037 ■ Antracite
046211 ■ Nero
163727 ■ Coffee

4000 K
600 lm
151960 € 2,75

4000 K
500 lm
253497 € 4,95



P. 702

Inside

Montatura in fusione d'alluminio verniciato a polveri con finitura antracite, coffee o grigio. Corpo luce posizionabile. Diffusore in vetro pirex trasparente. Dotato di lancia da interrare.

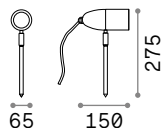

IP54

0,370 Kg / 0,0019 m³
G9 max 1x 15W

€ 34,10

115412 ■ Antracite
115429 ■ Nero
247045 ■ Coffee

4000 K
390 lm

209036 € 4,29



Zenith

Montatura in fusione d'alluminio verniciata a polveri con finitura antracite. Corpo luce posizionabile. Diffusore in materiale plastico.

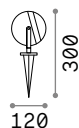

IP65

0,650 Kg / 0,0039 m³
GU10 max 1x 11W

€ 60,50

108407 ■ Antracite

4000 K
500 lm

253497 € 4,95



P. 754



Ulex

Proiettore orientabile per installazione a superficie, adatto per illuminazione generale o d'accento in esterni. Corpo in alluminio pressofuso, diffusore in vetro trasparente. Sorgente luminosa a led integrato, disponibile in due potenze. Indice di protezione IP65, resistenza all'urto IK06, temperatura di colore 3000K; durata utile LED 50.000 h. Disponibile in opzione con basetta di cablaggio, picchetto per installazione a terreno o visiera anti-abbagliamento.

Sorgente	LED SMD	Classe	I
Potenza	8,5W / 15W	isolamento	
Driver incluso	On/Off	IP	65
Driver disponibili	No	Materiale	Alluminio
CCT	3000 K		
CRI	≥80		
Durata LED	50.000 h		

PRO Prodotto ad alto contenuto tecnologico, elevata qualità dei materiali, destinato ad uso professionale.

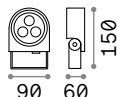

0,660 Kg/0,0024 m³
Lunghezza cavo 2000 mm

LED SMD OSRAM Driver ON/OFF incluso

Potenza	Angolo	Lumen	CCT	Finitura	Codice	€
8,5 W	30°	640 lm	3000 K	Antracite	261287	130,90

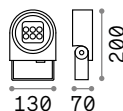

1,190 Kg/0,0042 m³
Lunghezza cavo 2000 mm

LED SMD OSRAM Driver ON/OFF incluso

Potenza	Angolo	Lumen	CCT	Finitura	Codice	€
15 W	30°	1280 lm	3000 K	Antracite	261294	209

OPTIONAL Non incluso



		Finitura	Codice	€
Box	8,5 W	Antracite	268156	31,90
	15 W	Antracite	268187	48,40



		Finitura	Codice	€
Picchetto	8,5 W	Antracite	268163	13,20
	15 W	Antracite	268194	16,50



		Finitura	Codice	€
Visiera	8,5 W	Antracite	268170	16,50
	15 W	Antracite	268200	24,20





Krypton

Corpo luce in acciaio spazzolato.
LED integrati. Diffusore
posizionabile per l'orientamento del
flusso luminoso.

LED Sorgente luminosa LED 3000/4000 K,
15.000 h di durata.

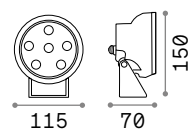

 IP65

3,090 Kg / 0,0024 m³
LED 7W / 530/620 lm

€ 202,40

269290	■ Acciaio	3000K
121970	■ Acciaio	4000K



Alien

Corpo luce orientabile in alluminio pressofuso verniciato a polveri. Diffusore in vetro temperato trasparente.

LED Sorgente luminosa LED 3000 K, 50.000 h di durata.

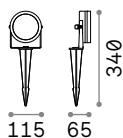

IP65

0,950 Kg / 0,0024 m³
LED 6W / 1030 lm

€ 130,90

255866 ■ Alluminio

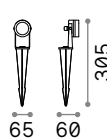

IP65

0,700 Kg / 0,0018 m³
LED 4W / 690 lm

€ 71,50

255859 ■ Alluminio

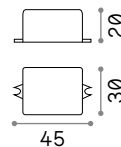

Driver
Non incluso
Necessario

€ 22

276212 7W
276526 10W

























Esterni

Incassi

Indice alfabetico

Bit	788
Ceci	796
Cecilia	797
Floor	793
Indio	790
Leo	790
Leti	791
Park	794
Park-Led	795
Rocket	799
Rocket-Mini	798
Taurus	792
Way	799
Wire	789

Indice icone

			
Bit 788	Wire 789	Indio 790	Leo 790
			
Leti Round 791	Leti Square 791	Taurus 792	Floor 793
			
Park Round 794	Park Square 794	Park Led 795	Ceci Round 796
			
Ceci Square 796	Cecilia 797	Rocket Mini 798	Rocket Mini 798
			
Rocket Mini 798	Rocket 799	Rocket 799	Way 799
			
Way 799	Way 799		



Bit

Corpo luce da incasso in alluminio pressofuso verniciato a polveri. Diffusore in vetro temperato trasparente. Disponibile nelle finiture antracite o bianco.

LED Sorgente luminosa LED 3000/4000 K, 35.000 h di durata.

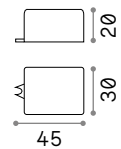
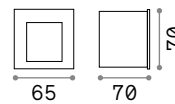

IP65

0,300 Kg / 0,0006 m³
LED 2W / 215/230 lm

€ 52,80

- 269023 ■ Bianco 3000K
- 269030 ■ Bianco 4000K
- 269009 ■ Antracite 3000K
- 269016 ■ Antracite 4000K

Driver
Non incluso
Necessario

€ 8,80

276205



Wire

Corpo luce da incasso in alluminio pressofuso verniciato a polveri. Diffusore in vetro temperato trasparente. Disponibile nelle finiture antracite o bianco.

LED Sorgente luminosa LED 3000 K, 20.000 h di durata.



255521

268996

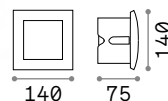

IP65

0,460 Kg / 0,0018 m³
LED 4W / 200 lm

€ 56,10

268989 ■ Bianco
255514 ■ Antracite

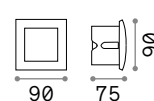

IP65

0,220 Kg / 0,0009 m³
LED 1,5W / 55 lm

€ 38,50

268996 ■ Bianco
255521 ■ Antracite

Indio

Corpo luce a incasso in alluminio pressofuso verniciato a polveri. Diffusore in vetro temperato serigrafato in bianco.

LED Sorgente luminosa LED 3000 K, 35.000 h di durata.

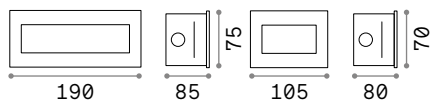

IP65

IP65

1,090 Kg / 0,0023 m³
LED 8W / 1170 lm

0,540 Kg / 0,0011 m³
LED 5W / 585 lm

€ 144,10

€ 93,50

255804 ■ Bianco

255781 ■ Bianco



Leo

Corpo luce a incasso in alluminio pressofuso verniciato a polveri. Diffusore in vetro temperato serigrafato in bianco con cornice in acciaio inox spazzolato.

LED Sorgente luminosa LED 3000/4000 K, 50.000 h di durata.

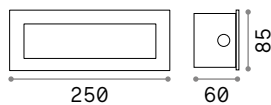

IP65

0,960 Kg / 0,0044 m³
LED 8W / 370/390 lm

€ 212,30

261409 ■ Acciaio 3000K
268224 ■ Acciaio 4000K





Leti

Corpo luce e diffusore in resina ad alte prestazioni: inattaccabile dalla corrosione sia di agenti atmosferici che di fertilizzanti chimici, colori stabilizzati da trattamento U.V., resistente a sbalzi termici da -60° C a + 90° C.

LED Lampadine LED GX53 3W 4000 K incluse.



096575	096599	096582
135	95	95
115	115	115
80	80	80
0,400 Kg / 0,0025 m ³ GX53 max 1x10W	0,400 Kg / 0,0025 m ³ GX53 max 1x10W	0,400 Kg / 0,0025 m ³ GX53 max 1x10W
€ 36,30	€ 36,30	€ 36,30
096544 Bianco 096568 Grigio 096551 Nero	096575 Bianco 096599 Grigio 096582 Nero	
4000 K 1000 lm	4000 K 1000 lm	
154008 € 7,15	154008 € 7,15	



Taurus

Spot multi-orientabile da incasso per installazione a pavimento, parete o controsoffitto. Corpo in alluminio pressofuso, ghiera in acciaio inox 316L, diffusore in vetro trasparente. Sorgente luminosa a led integrato, disponibile nelle versioni con 1, 2 o 3 moduli LED singolarmente orientabili di +/-30° mediante perno esterno per ampliare, restringere o direzionare il fascio luminoso complessivo. Calpestabile, indice di protezione IP67, resistenza all'urto IK09/IK10, temperatura di colore 3000K.

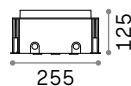
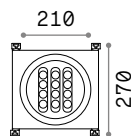

4,400 Kg / 0,0242 m³
LED 20W / 1950 Lm

€ 528

277035 ■ Acciaio

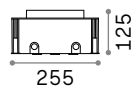
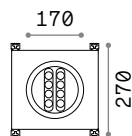

3,250 Kg / 0,0133 m³
LED 13,5W / 1300 Lm

€ 407

277028 ■ Acciaio

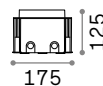
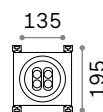

1,980 Kg / 0,0071 m³
LED 10W / 860 Lm

€ 319

277011 ■ Acciaio

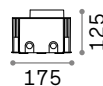
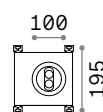

1,460 Kg / 0,0129 m³
LED 5,5W / 430 Lm

€ 209

277004 ■ Acciaio



Sorgente luminosa LED 3000 K,
50.000 h di durata.



Floor

Incasso fisso da esterni in alluminio pressofuso con ghiera rotonda disponibile in tre dimensioni, adatto per installazione a terra e a pavimento. Finitura in alluminio anodizzato con diffusore in vetro temprato extrachiario. LED integrati raffreddati passivamente con ottica di 30°; disponibile in temperatura di colore 3000 K e CRI \geq 80; grado di protezione IP 67; IK 10.

LED Sorgente luminosa LED 3000 K, 30.000 h di durata.

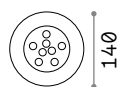

140

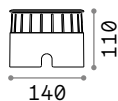

110



0,960 Kg / 0,0049 m³
LED 12W / 1560 Lm

€ 105,60

255682 ■ Acciaio

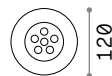

120

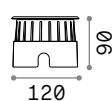

90



0,640 Kg / 0,0015 m³
LED 6W / 780 Lm

€ 72,60

255668 ■ Acciaio



90

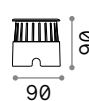

90



0,390 Kg / 0,0010 m³
LED 3W / 390 Lm

€ 55

255651 ■ Acciaio



Park

Spot da incasso. Corpo luce esterno in PVC. Parabola riflettente in alluminio. Cornice blocca vetro in acciaio satinato. Vetro trasparente.

150	120	120
195	135	125
105	75	83
1,210 Kg / 0,0066 m ³ E27 max 1x60W	0,580 Kg / 0,0032 m ³ GU10 max 1x20W	0,900 Kg / 0,0031 m ³ G9 max 1x15W
€ 77	€ 55	€ 77
032825 ■ Acciaio	032832 ■ Acciaio	117881 ■ Acciaio
4000 K 980 lm	4000 K 500 lm	4000 K 390 lm
153964 € 7,70	253497 € 4,95	209036 € 4,29



Park Led

Diffusore in vetro temperato trasparente. Calpestabile. Sorgente luminosa a led integrato. Assenza di viti a vista. Disponibile con due versioni di cassaforma ad altezza diversa per una maggiore versatilità d'installazione.

LED Sorgente luminosa LED 4000 K, 50.000 h di durata.

IP68 Grado di protezione IP68.

S316 Articolo in acciaio inox 316.



2,150 Kg / 0,0028 m³
LED 11,5W / 1350 lm

€ 275

222851 ■ Acciaio 60°



1,270 Kg / 0,0018 m³
LED 4,8W / 520 lm

€ 181,50

222868 ■ Acciaio 15°
222875 ■ Acciaio 60°

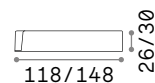

Driver
Non incluso
Necessario

€ 38,50/49,50

226187 20W
226194 35W

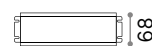
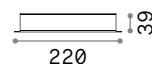

Driver
Non incluso
Necessario

€ 170,50/192,50

226200 100W
226217 185W



Ceci

Corpo luce e diffusore in resina ad alte prestazioni: inattaccabile dalla corrosione sia di agenti atmosferici che di fertilizzanti chimici, colori stabilizzati da trattamento U.V., resistente a sbalzi termici da -60° C a + 90° C. Carrabile fino a 5000 Kg.

LED Lampadine LED GU10 3,5W e LED GX53 10W 4000 K incluse.

<p>IP67 <small>INCLUSA</small></p>	<p>IP67 <small>INCLUSA</small></p>	<p>IP67 <small>INCLUSA</small></p>	<p>IP67 <small>INCLUSA</small></p>
<p>0,670 Kg / 0,0043 m³ GX53 max 1x 10W</p>	<p>0,270 Kg / 0,0019 m³ GU10 max 1x 6W</p>	<p>0,700 Kg / 0,0044 m³ GX53 max 1x 10W</p>	<p>0,270 Kg / 0,0019 m³ GU10 max 1x 6W</p>
<p>€ 84,70</p>	<p>€ 58,30</p>	<p>€ 84,70</p>	<p>€ 58,30</p>
<p>120324 ■ Nero</p>	<p>120249 ■ Nero</p>	<p>120386 ■ Nero</p>	<p>120317 ■ Nero</p>
<p> 4000 K 1000 lm</p>	<p> 4000 K 500 lm</p>	<p> 4000 K 1000 lm</p>	<p> 4000 K 500 lm</p>
<p>154008 € 7,15</p>	<p>253497 € 4,95</p>	<p>154008 € 7,15</p>	<p>253497 € 4,95</p>



Cecilia

Corpo luce e diffusore in resina ad alte prestazioni: inattaccabile dalla corrosione sia di agenti atmosferici che di fertilizzanti chimici, colori stabilizzati da trattamento U.V., resistente a sbalzi termici da -60°C a $+90^{\circ}\text{C}$. Carrabile fino a 5000 Kg.

LED

Lampadine LED GU10 3,5W e LED GX53 10W 4000 K incluse.



120362



120287

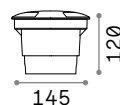

0,740 Kg / 0,0043 m³
GX53 max 1x10W

€ 121

120362 ■ Nero

4000 K
1000 lm

154008

€ 7,15

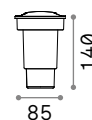

0,260 Kg / 0,0020 m³
GU10 max 1x6W

€ 80,30

120287 ■ Nero

4000 K
500 lm

253497

€ 4,95



212623-212647

222820

222837

Rocket Mini

Diffusore in vetro temperato trasparente. Calpestabile. Sorgente luminosa a led integrato. Assenza di viti a vista. Disponibile nelle versioni a 1, 2 luci in radenza pavimento oppure con unica luce centrale d'accento.

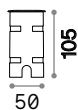

0,280 Kg / 0,0008 m³
LED 2W / 169 lm

€ 95,70

212623 ■ Acciaio 15°
212647 ■ Acciaio 40°

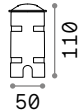

0,330 Kg / 0,0008 m³
LED 2W / 160 lm

€ 128,70/141,90

222820 ■ Acciaio
222837 ■ Acciaio

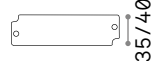
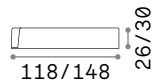

Driver
Non incluso
Necessario

€ 38,50/49,50

226187 20W
226194 35W

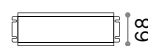
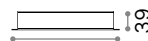

Driver
Non incluso
Necessario

€ 170,50/192,50

226200 100W
226217 185W

LED

Sorgente luminosa LED 4000 K, 50.000 h di durata.

IP68

Grado di protezione IP68.

S316

Articolo in acciaio inox 316.

Rocket

Apparecchio da incasso calpestabile. Corpo luce in acciaio spazzolato. Diffusore in vetro temperato.

LED Sorgente luminosa LED 3000/4000 K, 50.000 h di durata.

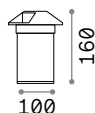
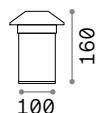

IP65

IP65

0,560 Kg / 0,0034 m³
LED 3W / 270/290 lm

0,560 Kg / 0,0034 m³
LED 3W / 270/290 lm

€ 130,90

€ 130,90

247144 ■ Acciaio 3000K 122014 ■ Acciaio 4000K

247151 ■ Acciaio 3000K 122021 ■ Acciaio 4000K



Way

Apparecchio da incasso calpestabile. Corpo luce e diffusore in resina ad alte prestazioni: anti corrosione, anti U.V., da -60°a +90° C. Colore: nero.

LED Lampadine LED G9 1,7W 3000/4000 K incluse. Cod. 270104/270111

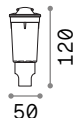
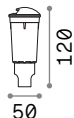
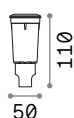

IP67

IP67

IP67

0,100 Kg / 0,0007 m³
G9 max 1x1,7W

0,080 Kg / 0,0007 m³
G9 max 1x1,7W

0,080 Kg / 0,0007 m³
G9 max 1x1,7W

€ 30,80

€ 30,80

€ 30,80

269726 ■ N 3000K
269733 ■ N 4000K

269504 ■ N 3000K
269696 ■ N 4000K

269702 ■ N 3000K
269719 ■ N 4000K

270104 3000K
€ 9,79
270111 4000K
€ 9,79

270104 3000K
€ 9,79
270111 4000K
€ 9,79

270104 3000K
€ 9,79
270111 4000K
€ 9,79





Lampadine* e accessori

new



E14 802

new



E27 804

new



G4 810

new



G9 810

new



GX53 811

new



R7s 811

new



GU10 812

new



Strip 814



Kit Emergency 815

new



Ceiling Cups 816

new



Bulb Holders 818



Cables 818











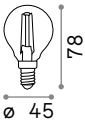

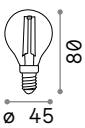

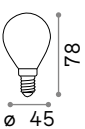

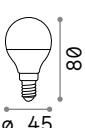

Cables Holders 818

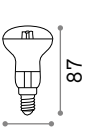
* Per le lampadine e strip led al prezzo indicato non sono applicabili ulteriori promozioni.

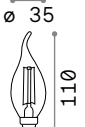

Lampadine E14

		Lamp socket	Power	Flux	CCT	CRI	Dimmable	Life	Min Qty.	Code	€
		E14	4 W	480 lm	3000 K	80		25.000 h	10	101200	3,30
		E14	4 W	470 lm	3000 K	80	TRIAC	15.000 h	10	188935	4,29
		E14	4 W	520 lm	4000 K	80		25.000 h	10	153926	3,30
		E14	4 W	420 lm	3000 K	90		25.000 h	10	271620	3,30
		E14	4 W	300 lm	2200 K	80		15.000 h	10	151656	6,05
		E14	4 W	420 lm	3000 K	80		25.000 h	10	101217	3,30
		E14	4 W	340 lm	3000 K	80	TRIAC	25.000 h	10	289229	4,29 new
		E14	4 W	470 lm	4000 K	80		25.000 h	10	253411	3,30
		E14	4 W	340 lm	3000 K	90		25.000 h	10	289212	3,30 new
		E14	6 W	600 lm	3000 K	80		25.000 h	10	151731	3,30
		E14	6 W	600 lm	4000 K	80		25.000 h	10	151946	3,30
		E14	4 W	210 lm	3000 K	80		25.000 h	10	101262	4,95
		E14	4 W	300 lm	3000 K	80		25.000 h	10	101255	4,95
		Lamp socket	Power	Flux	CCT	CRI	Dimmable	Life	Min Qty.	Code	€
		E14	4 W	430 lm	3000 K	80		25.000 h	10	101248	3,30
		E14	4 W	520 lm	3000 K	80	TRIAC	15.000 h	10	188911	4,29
		E14	4 W	460 lm	4000 K	80		25.000 h	10	153940	3,30
		E14	4 W	400 lm	2200 K	80		15.000 h	10	151663	6,05
		E14	4 W	380 lm	3000 K	80		25.000 h	10	151793	3,30

Lampadine E14

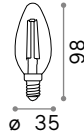

Lamp socket	Power	Flux	CCT	CRI	Dimmable	Life	Min Qty.	Code	€
E14	4W	450 lm	2700 K	80		25.000 h	10	270944	3,30
E14	4W	470 lm	3000 K	80		25.000 h	10	101224	3,30
E14	4W	340 lm	3000 K	80	TRIAC	15.000 h	10	188928	4,29
E14	4W	490 lm	4000 K	80		25.000 h	10	153933	3,30
E14	4W	430 lm	3000 K	90		25.000 h	10	271644	3,30

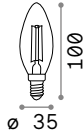

E14	4W	370 lm	2200 K	80		15.000 h	10	151649	6,05
-----	----	--------	--------	----	--	----------	----	--------	------

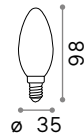

E14	4W	370 lm	3000 K	80		25.000 h	10	101231	3,30
-----	----	--------	--------	----	--	----------	----	--------	------

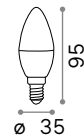

E14	6W	520 lm	3000 K	80		25.000 h	10	151748	3,30
E14	6W	520 lm	4000 K	80		25.000 h	10	151953	3,30



151663



151793



101224



151649



101231













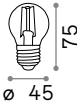



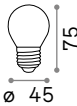

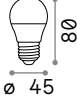
101200



101262



Lampadine E27

		Lamp socket	Power	Flux	CCT	CRI	Dimmable	Life	Min Qty.	Code	€
		E27	4 W	490 lm	2700 K	80		25.000 h	10	271637	3,30
		E27	4 W	430 lm	3000 K	80		25.000 h	10	101279	3,30
		E27	4 W	370 lm	3000 K	80	TRIAC	15.000 h	10	188942	3,30
		E27	4 W	490 lm	4000 K	80		25.000 h	10	153957	3,30
		E27	4 W	320 lm	3000 K	90		25.000 h	10	289236	3,30 <small>new</small>
		E27	4 W	380 lm	2200 K	80		15.000 h	10	151861	6,05
		E27	4 W	340 lm	3000 K	80		25.000 h	10	101286	3,30
		E27	6 W	600 lm	3000 K	80		25.000 h	10	151755	2,75
		E27	6 W	600 lm	4000 K	80		25.000 h	10	151960	2,75
		E27	4 W	480 lm	3000 K	80		25.000 h	10	101293	3,30
		E27	4 W	520 lm	4000 K	80		25.000 h	10	253428	3,30
		E27	8 W	930 lm	2700 K	80		25.000 h	10	270951	7,70
		E27	8 W	910 lm	3000 K	80		25.000 h	10	119571	7,70
		E27	8 W	880 lm	3000 K	80	TRIAC	15.000 h	10	188973	8,25
		E27	8 W	980 lm	4000 K	80		25.000 h	10	153964	7,70
		E27	8 W	880 lm	3000 K	90		25.000 h	10	271613	7,70
		E27	10 W	1300 lm	3000 K	80		25.000 h	10	256528	7,70
		E27	10 W	1380 lm	4000 K	80		25.000 h	10	270920	7,70
		E27	4 W	370 lm	2200 K	80		15.000 h	10	151687	6,05
		E27	8 W	900 lm	3000 K	80		25.000 h	10	123899	7,70
		E27	8 W	860 lm	3000 K	80	TRIAC	25.000 h	10	252209	8,25
		E27	8 W	1030 lm	4000 K	80		25.000 h	10	253459	7,70
		E27	8 W	780 lm	3000 K	90		25.000 h	10	289250	8,25 <small>new</small>
		E27	10 W	1000 lm	3000 K	80		25.000 h	10	151762	2,75
		E27	10 W	1000 lm	4000 K	80		25.000 h	10	151991	2,75
		E27	8 W	770 lm	3000 K	80		25.000 h	10	123882	8,25

Lampadine E27

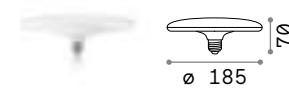
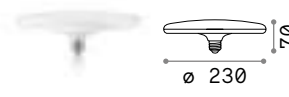
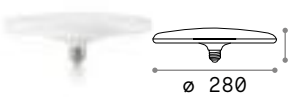
	Lamp socket	Power	Flux	CCT	CRI	Dimmable	Life	Min Qty.	Code	€
	E27	26 W	2350lm	3000 K	80		30.000 h	1	189147	19,80
	E27	35 W	3100lm	3000 K	80		30.000 h	1	189154	28,60
	E27	48 W	4300lm	3000 K	80		30.000 h	1	189161	38,50



101279



151861



101293













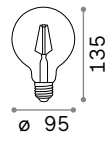

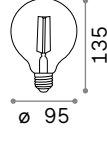
123882

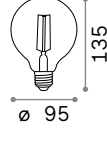

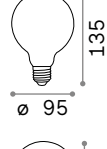
189154

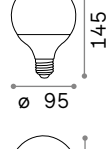

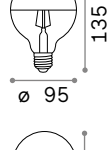
Lampadine E27

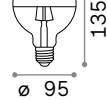
	Lamp socket	Power	Flux	CCT	CRI	Dimmable	Life	Min Qty.	Code	€	
		E27	8 W	1120 lm	3000 K	80	25.000 h	10	101323	8,25	
		E27	8 W	880 lm	3000 K	80	TRIAC	15.000 h	10	188966	9,35
		E27	8 W	1120 lm	4000 K	80		25.000 h	10	153971	8,25
		E27	8 W	860 lm	3000 K	90		25.000 h	10	271606	8,25
		E27	4 W	500 lm	2200 K	80	15.000 h	10	151717	9,79	
		E27	4 W	350 lm	2200 K	80	TRIAC	15.000 h	10	223933	8,25
		E27	4 W	200 lm	2200 K	80	15.000 h	10	204475	10,89	
		E27	8 W	950 lm	3000 K	80	25.000 h	10	101330	8,80	
		E27	8 W	860 lm	3000 K	80	TRIAC	25.000 h	10	252186	9,35
		E27	8 W	1050 lm	4000 K	80		25.000 h	10	253442	8,80
		E27	8 W	770 lm	3000 K	90		25.000 h	10	289243	8,80 new
		E27	15 W	1820 lm	3000 K	80	25.000 h	10	151779	6,05	
		E27	15 W	1820 lm	4000 K	80		25.000 h	10	151977	6,05
		E27	8 W	1050 lm	3000 K	80	25.000 h	10	157597	11,55	
		E27	9 W	930 lm	3000 K	80	25.000 h	10	135526	11,55	



101330



157597



135526

Lampadine E27



Lamp socket	Power	Flux	CCT	CRI	Dimmable	Life	Min Qty.	Code	€
E27	8 W	1020 lm	3000 K	80		25.000 h	10	101347	9,35
E27	8 W	880 lm	3000 K	80	TRIAC	15.000 h	10	188959	9,90
E27	8 W	1070 lm	4000 K	80		25.000 h	10	153988	9,35
E27	8 W	860 lm	3000 K	90		25.000 h	10	271590	9,35
E27	4 W	480 lm	2200 K	80		15.000 h	10	151724	10,89
E27	4 W	350 lm	2200 K	80	TRIAC	15.000 h	10	223926	9,35
E27	4 W	200 lm	2200 K	80		15.000 h	10	204468	12,10
E27	8 W	900 lm	3000 K	80		25.000 h	10	101354	9,35
E27	8 W	1030 lm	4000 K	80		25.000 h	10	253435	9,35
E27	18 W	2180 lm	3000 K	80		25.000 h	10	151786	8,80
E27	18 W	2180 lm	4000 K	80		25.000 h	10	152004	8,80
E27	8 W	1050 lm	3000 K	80		25.000 h	10	157580	12,10



101347













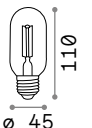

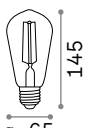
151724

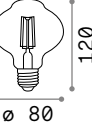

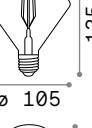
204468

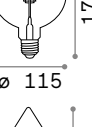

Lampadine E27

		Lamp socket	Power	Flux	CCT	CRI	Dimmable	Life	Min Qty.	Code	€
		E27	4 W	330 lm	2200 K	80		15.000 h	10	151700	6,05
		E27	4 W	440 lm	2200 K	80		15.000 h	10	151694	7,70
		E27	4 W	290 lm	2200 K	80	TRIAC	15.000 h	10	223919	7,70
		E27	4 W	360 lm	2200 K	80		15.000 h	10	201283	6,49
		E27	4 W	360 lm	2200 K	80		15.000 h	10	201269	12,10
		E27	4 W	360 lm	2200 K	80		15.000 h	10	201290	13,75
		E27	4 W	360 lm	2200 K	80		15.000 h	10	201276	13,75



151700

151694

201283

201269

201290

201276

Lampadine E27

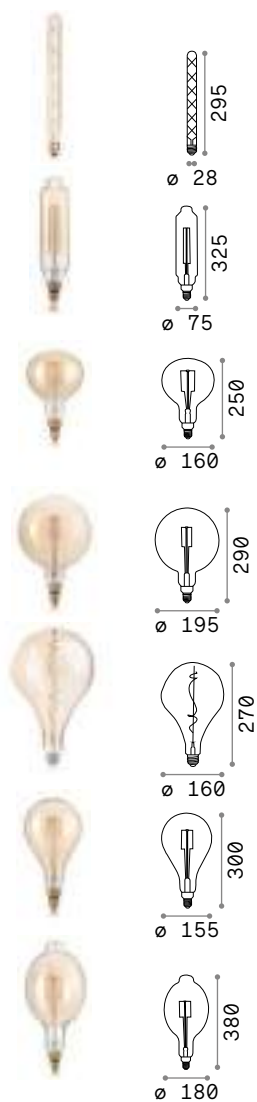

Lamp socket	Power	Flux	CCT	CRI	Dimmable	Life	Min Qty.	Code	€
E27	6 W	580 lm	2200 K	80		15.000 h	10	201252	12,10
E27	4 W	320 lm	2200 K	80		15.000 h	1	130170	38,50
E27	4 W	320 lm	2200 K	80		15.000 h	1	129877	33,00
E27	4 W	390 lm	2200 K	80	TRIAC	15.000 h	1	223940	33,00
E27	4 W	400 lm	2200 K	80		25.000 h	1	130187	33,00
E27	4 W	390 lm	2200 K	80	TRIAC	15.000 h	1	223834	38,50
E27	4 W	360 lm	2200 K	80		25.000 h	1	237251	27,50
E27	8 W	700 lm	2200 K	80		25.000 h	1	130163	33,00
E27	4 W	320 lm	2200 K	80		15.000 h	1	129860	38,50



201252

130170

129877

130187

237251

130163

129860



Lampadine G4

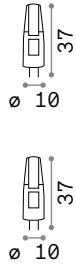

Lamp socket	Power	Flux	CCT	CRI	Dimmable	Life	Min Qty.	Code	€
G4	1,5W	200lm	3000K	80		15.000 h	20	188980	7,15
G4	1,5W	170lm	3000K	90		15.000 h	20	288345	7,15 <i>new</i>
G4	2W	160lm	3000K	80		20.000 h	20	222257	4,95
G4	2W	180lm	3000K	80	Phase-cut	25.000 h	20	266282	7,59 <i>new</i>

Lampadine G9

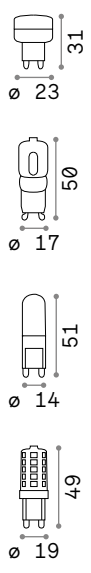

Lamp socket	Power	Flux	CCT	CRI	Dimmable	Life	Min Qty.	Code	€
G9	1,7W	150lm	3000K	80		25.000 h	20	270104	9,79
G9	1,7W	150lm	4000K	80		25.000 h	20	270111	9,79
G9	2,5W	200lm	3000K	80		20.000 h	20	122168	3,30
G9	2,5W	210lm	4000K	80		20.000 h	20	253381	3,30
G9	2,5W	300lm	4000K	80	TRIAC	25.000 h	20	253473	8,80
G9	3W	350lm	2700K	80		15.000 h	20	270968	4,29
G9	3W	370lm	3000K	80		15.000 h	20	209043	4,29
G9	3W	300lm	3000K	80	TRIAC	15.000 h	20	288215	6,05 <i>new</i>
G9	3W	390lm	4000K	80		15.000 h	20	209036	4,29
G9	3W	370lm	3000K	90		15.000 h	20	288208	4,29 <i>new</i>

Lampadine GX53

101385

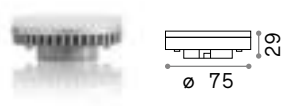

Lamp socket	Power	Flux	CCT	CRI	Dimmable	Life	Min Qty.	Code	€
GX53	7W	560 lm	3000 K	80		25.000 h	10	101385	7,37
GX53	7W	600 lm	4000 K	80		25.000 h	10	253404	7,37
GX53	9W	910 lm	3000 K	80		25.000 h	10	123936	7,15
GX53	9W	760 lm	3000 K	80	TRIAC	25.000 h	10	252551	10,89
GX53	9W	1000 lm	4000 K	80		25.000 h	10	154008	7,15
GX53	9W	800 lm	4000 K	80	TRIAC	25.000 h	10	252568	10,89
GX53	9W	760 lm	3000 K	90		25.000 h	10	288383	7,15 new

Lampadine R7s



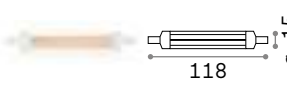

189109



Lamp socket	Power	Flux	CCT	CRI	Dimmable	Life	Min Qty.	Code	€
R7s	6W	380 lm	3000 K	80		20.000 h	10	189109	15,95
R7s	6W	400 lm	3000 K	80	TRIAC	20.000 h	10	266770	17,05
R7s	6W	450 lm	4000 K	80		20.000 h	10	272375	15,95
R7s	6W	430 lm	4000 K	80	TRIAC	20.000 h	10	272382	17,05
R7s	7W	560 lm	3000 K	80		20.000 h	10	189093	20,35
R7s	8W	580 lm	3000 K	80	TRIAC	20.000 h	10	266763	22,00
R7s	7W	640 lm	4000 K	80		20.000 h	10	253480	20,35
R7s	8W	640 lm	4000 K	80	TRIAC	20.000 h	10	266756	22,00

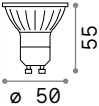

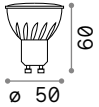
Lampadine GU10

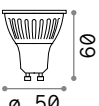
	Lamp socket	Power	Flux	CCT	CRI	Beam	Dimm.	Life	Min Qty.	Code	€
 	GU10	5W	480 lm	3000 K	80	31°		15.000 h	10	108292	4,95
	GU10	5W	470 lm	3000 K	80	31°	TRIAC	15.000 h	10	266251	4,95 <i>new</i>
	GU10	5W	500 lm	4000 K	80	31°		15.000 h	10	253497	4,95
	GU10	5W	500 lm	4000 K	80	31°	TRIAC	15.000 h	10	285566	4,95 <i>new</i>
	GU10	7W	630 lm	3000 K	80	41°		25.000 h	10	123943	4,95
	GU10	7W	670 lm	3000 K	80	47°	TRIAC	25.000 h	10	288239	6,49 <i>new</i>
	GU10	7W	720 lm	4000 K	80	41°		25.000 h	10	224367	4,95
	GU10	7W	540 lm	3000 K	90	47°		25.000 h	10	288222	9,90 <i>new</i>
 	GU10	7W	560 lm	3000 K	80	108°		25.000 h	10	101378	9,90
	GU10	7W	630 lm	4000 K	80	108°		25.000 h	10	117652	9,90
 	GU10	8W	800 lm	3000 K	80	32°		25.000 h	10	189062	9,90
	GU10	8W	840 lm	4000 K	80	32°		25.000 h	10	270975	9,90



108292



101378



189062

Lampadine GU10

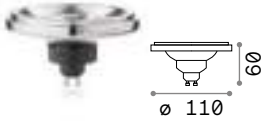
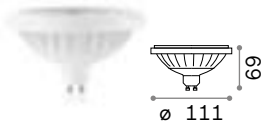
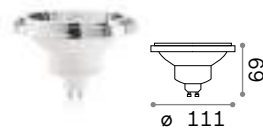
	Lamp socket	Power	Flux	CCT	CRI	Beam	Dimm.	Life	Min Qty.	Code	€
	GU10	12 W	960 lm	3000 K	80	23°		25.000 h	10	242040	15,95
	GU10	12 W	900 lm	3000 K	80	23°	TRIAC	25.000 h	10	266305	17,60 <i>new</i>
	GU10	12 W	1190 lm	4000 K	80	23°		25.000 h	10	285573	15,95 <i>new</i>
	GU10	12 W	1120 lm	3000 K	80	46°		25.000 h	10	183794	15,95
	GU10	12 W	1240 lm	4000 K	80	46°		25.000 h	10	253466	15,95
	GU10	13 W	1300 lm	3000 K	80	46°	TRIAC	25.000 h	10	266299	20,35 <i>new</i>
	GU10	10 W	800 lm	3000 K	80	20°		15.000 h	10	189031	16,50
	GU10	10 W	820 lm	4000 K	80	20°		15.000 h	10	253398	16,50
	GU10	13 W	950 lm	3000 K	80	24°	TRIAC	15.000 h	10	288543	20,90 <i>new</i>



242040



183794



189031



Strip LED and Drivers new

Volt 24 Vdc
 MacAdam SDCM 3
 Beam 115°
 LED life 35.000 h

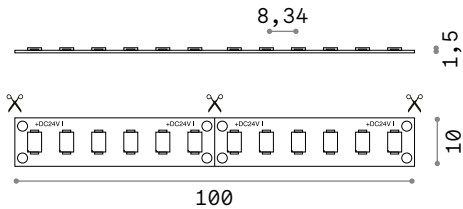

SMD 2835 120 LED/m CRI ≥90

Power	IP	Flux	CCT	Length	Code	€
14,4 W/m	IP20	1370 lm/m	2700 K	5000 mm	272498	55,00 new
		1400 lm/m	3000 K	5000 mm	272481	55,00 new
	1450 lm/m	4000 K	5000 mm	272474	55,00 new	
	IP65	1400 lm/m	3000 K	5000 mm	272504	71,50 new
		1450 lm/m	4000 K	5000 mm	287959	71,50 new

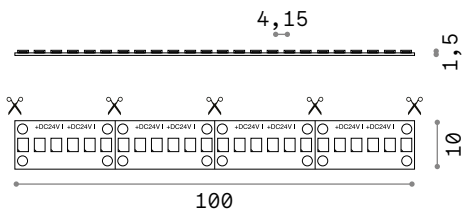

SMD 2835 240 LED/m CRI ≥90

Power	IP	Flux	CCT	Length	Code	€
19,2 W/m	IP20	1600 lm/m	2700 K	5000 mm	272535	88,00 new
		1650 lm/m	3000 K	5000 mm	272528	88,00 new
	1700 lm/m	4000 K	5000 mm	272511	88,00 new	
	IP65	1650 lm/m	3000 K	5000 mm	272542	99,00 new
		1700 lm/m	4000 K	5000 mm	287966	99,00 new

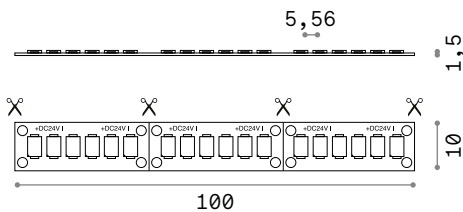

SMD 2835 180 LED/m CRI ≥90

Power	IP	Flux	CCT	Length	Code	€
39 W/m	IP20	3700 lm/m	3000 K	3000 mm	253886	132,00
		3900 lm/m	4000 K	3000 mm	253893	132,00

814

Solo per installazione in interni



Driver	Power	Output	Class	Measure	Code	€
On-Off	30 W	24 Vdc	□	140 x 45 x 28 mm	124070	19,25
	60 W	24 Vdc	□	186 x 50 x 33 mm	124087	33,00
	100 W	24 Vdc	⊕	127 x 97 x 30 mm	124100	49,50
	150 W	24 Vdc	⊕	159 x 97 x 30 mm	124117	55,00
	200 W	24 Vdc	⊕	215 x 115 x 30 mm	153001	71,50
1-10V/Push	36 W	24 Vdc	□	175 x 44 x 30 mm	244556	71,50
	75 W	24 Vdc	⊕	295 x 43 x 30 mm	244570	137,50
	150 W	24 Vdc	⊕	273 x 57 x 37 mm	244594	192,50
DALI/Push	36 W	24 Vdc	□	175 x 44 x 30 mm	244549	115,50
	75 W	24 Vdc	⊕	295 x 43 x 30 mm	244563	176,00
	150 W	24 Vdc	⊕	273 x 57 x 37 mm	244587	258,50



Kit emergency

Kit luce d'emergenza per moduli LED. Include inverter e batteria. Autonomia da due a tre ore con un tempo di ricarica rispettivamente di 12 e 24 ore. Funzionamento in sola emergenza o in luce continua (luce continua in abbinamento con alimentatori elettronici e alimentatori elettronici dimmerabili). Protetto in classe II.



INVERTER

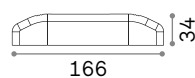

IP20

0,185 Kg / 0,0009 m³

52 mm

GROUP BATTERY

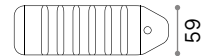
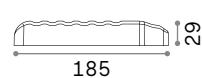

0,305 Kg / 0,0010 m³

65 mm

€ 110

221595 Bianco

Per ulteriori informazioni, si prega di contattare l'ufficio tecnico.



Rosoni

Rosoni magnetici

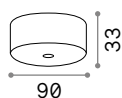

1 cavo



244235 € 15,40 244259 € 15,40 249315 € 18,70 249308 € 18,70 244242 € 15,40

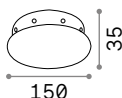

8 cavi



272429 € 29,70 new 272436 € 29,70 new 272443 € 40,70 new 272450 € 40,70 new 272467 € 29,70 new

Rosoni all in

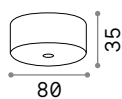

3 cavi



285733 € 27,50 new 285740 € 27,50 new 285771 € 33,00 new 285764 € 33,00 new 285757 € 27,50 new

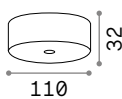

6 cavi



285788 € 33,00 new 285795 € 33,00 new 285825 € 44,00 new 285818 € 44,00 new 285801 € 33,00 new

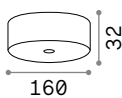

12 cavi



285832 € 49,50 new 285849 € 49,50 new 285870 € 60,50 new 285863 € 60,50 new 285856 € 49,50 new

Rosoni standard

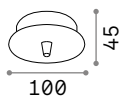

1 cavo



122823 € 7,59 122830 € 7,59 249278 € 8,80 249261 € 8,80 123295 € 7,59

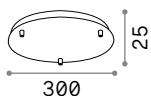

3 cavi



285580 € 49,50 ^{new} 285597 € 49,50 ^{new} 285627 € 71,50 ^{new} 285610 € 71,50 ^{new} 285603 € 49,50 ^{new}

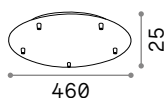

5 cavi



285634 € 82,50 ^{new} 285641 € 82,50 ^{new} 285672 € 110,00 ^{new} 285665 € 110,00 ^{new} 285658 € 82,50 ^{new}

Rosoni lineari

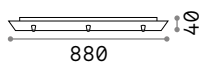

3 cavi



122854 € 38,50 122861 € 38,50 249292 € 44,00 249285 € 44,00 123301 € 38,50

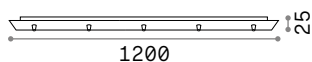

5 cavi



285689 € 60,50 ^{new} 285696 € 60,50 ^{new} 285726 € 77,00 ^{new} 285719 € 77,00 ^{new} 285702 € 60,50 ^{new}



Accessori

Portalampada

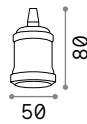

249186 € 14,30 249193 € 14,30 249223 € 14,30 249216 € 14,30 249209 € 14,30



242569 € 7,15 249230 € 7,15 249254 € 7,15 249247 € 7,15 242576 € 7,15

Cavi

Ø 5x1000 mm
2x0,75 mm²
FEPT180°
PVC T90°



128849 € 3,30/m 038940 € 3,30/m 249179 € 3,30/m 249162 € 3,30/m 128832 € 3,30/m

Supporti



143200 € 6,49 143224 € 6,49 249339 € 6,49 249322 € 6,49 143217 € 6,49



285887 € 6,49 *new* 285894 € 6,49 *new* 285924 € 6,49 *new* 285917 € 6,49 *new* 285900 € 6,49 *new*





Indice per codice

deal lux



Indice per codice

SKU	Pag	009483	387	020228	702	031668	322	036021	285	051987	346
		009513	345	020556	203	031743	179	036045	322	052359	127
000206	441	009537	345	020723	118	031750	179	038025	358	052366	127
000251	443	009681	186	020747	118	031996	146	038940	818	052373	127
000268	443	009698	186	020822	234	032009	146	041742	486	052786	145
000305	377	009704	227	020839	234	032016	146	041827	205	052793	162
000619	425	009933	346	020846	420	032023	279	042794	479	052809	162
000657	318	009940	346	020853	461	032030	279	043562	156	052816	162
001197	479	009957	346	020877	505	032047	279	044163	414	052991	326
001814	139	010861	277	020891	287	032078	440	044187	192	053004	326
001821	139	012865	234	021416	248	032122	156	044194	192	053011	326
002408	223	012872	234	021430	248	032139	156	044200	192	053448	129
002705	386	012889	461	022222	324	032351	182	044248	228	057187	225
002774	386	012902	420	022239	324	032368	449	044255	228	057194	225
002880	505	012919	132	022277	396	032375	449	044279	273	057200	417
003399	211	013046	423	022987	505	032382	495	044286	273	059129	321
003528	478	013060	423	023021	129	032436	452	044293	273	059136	321
004099	227	013244	132	023038	129	032467	452	044422	229	059143	321
004716	706	013657	439	024097	770	032504	217	044453	229	059181	192
004723	758	014166	347	024134	730	032825	794	044491	465	059211	417
004730	758	014395	223	025032	211	032832	794	044590	445	059228	504
005041	122	014432	373	025278	123	033013	712	044606	445	059235	208
005294	362	014609	494	025285	123	033020	712	044767	203	059242	208
005379	370	014623	423	025308	123	033037	780	044774	203	059259	467
005386	370	014630	423	025315	123	033044	780	044910	419	059266	467
005454	362	014814	360	025438	183	033532	205	044927	222	059679	142
005881	225	015101	424	026473	361	033662	152	044934	222	059808	360
005898	225	015118	424	026480	361	033679	152	045030	439	059815	360
005911	244	015125	424	026558	362	033952	129	045047	439	059822	360
006161	377	015132	424	026787	130	034546	344	045115	153	059839	280
006321	304	015286	478	026954	758	034706	216	045122	153	060491	419
006338	304	015965	467	026961	758	034713	216	045139	442	060507	222
007021	370	016122	321	026978	706	034720	216	045191	392	060514	222
007038	370	016399	400	026985	758	034935	454	045207	392	060620	358
007045	370	016863	178	026992	758	034942	454	045214	392	061115	480
007069	370	016931	138	027005	706	035185	345	045627	366	061122	480
007533	248	017082	361	027081	363	035369	503	045634	366	061139	480
007960	286	017297	371	027098	363	035574	210	045726	288	061160	437
007977	286	017303	371	027104	363	035581	210	045733	288	061191	437
007984	286	017310	371	027289	475	035604	218	046167	702	061450	708
007991	286	017327	373	027357	126	035611	218	046181	702	061467	708
008349	194	017334	373	027364	126	035628	218	046211	780	061474	708
008356	462	017440	128	027418	217	035635	218	046471	486	061580	721
008363	194	017518	349	027821	217	035642	418	046723	486	061597	721
008370	330	017617	358	027852	400	035659	418	047799	152	062211	203
008455	330	018089	321	027876	400	035666	133	049229	347	062273	489
008608	287	018508	277	027906	140	035680	133	049236	347	066387	192
008615	287	018515	715	028460	417	035697	133	051406	465	066394	192
008622	287	018522	715	030326	130	035703	133	051444	349	066431	208
008851	373	018775	425	030784	324	035710	133	051741	489	066448	208
009087	156	018829	387	031071	386	035727	145	051765	489	066592	145
009131	441	018836	387	031095	386	035826	191	051840	363	066608	145
009148	156	018850	304	031361	347	035840	191	051857	363	066868	721
009155	441	019499	203	031460	377	035864	416	051864	363	068138	286
009223	279	019635	287	031477	377	035949	411	051932	346	068145	286
009360	108	019734	147	031484	367	035956	411	051949	346	068169	144
009377	387	019741	147	031491	367	035987	453	051956	346	068183	232
009391	108	019758	278	031507	373	036007	453	051963	346	068190	232
009407	108	019765	278	031651	322	036014	285	051970	346	068268	416

068275	503	081519	212	089584	304	094236	162	101101	138	109145	758
068299	190	081526	212	089591	304	094649	325	101125	147	110233	495
068305	463	081540	212	089669	127	094663	325	101132	278	110240	495
068459	167	081557	212	089775	761	094687	324	101163	181	110356	488
068466	167	081564	212	089805	493	094786	244	101170	324	110363	488
071015	142	081762	152	090337	342	095226	148	101187	324	110417	110
071022	142	082059	165	090481	166	095264	355	101194	324	110424	110
073132	236	082073	165	090863	284	095288	355	101200	802	110431	110
073149	236	082158	201	090900	284	095615	228	101217	802	110448	449
073187	320	082172	201	091006	273	095639	228	101224	802	110455	449
073255	320	082196	201	091013	273	095998	357	101231	802	110462	110
073262	320	082240	732	091112	153	096018	357	101248	802	110530	449
073408	466	082257	201	091129	347	096100	167	101255	802	110554	449
073422	466	082264	414	091136	347	096162	167	101262	802	110745	132
073439	466	082271	732	091518	702	096476	700	101279	804	110752	132
073521	384	082288	414	091525	702	096483	700	101286	804	110868	187
073545	384	082783	325	092188	722	096544	791	101293	804	111117	310
073569	384	082790	325	092195	722	096551	791	101323	804	111452	498
073583	300	083070	676	092201	722	096568	791	101330	804	111841	170
073712	306	083087	676	092218	715	096575	791	101347	804	111858	170
073729	224	083117	676	092225	766	096582	791	101354	804	111865	170
074139	166	083124	676	092300	712	096599	791	101378	812	111872	210
074245	131	083131	676	092317	712	096667	726	101385	811	111896	210
074313	131	083148	676	092324	689	096674	726	101491	731	111902	162
074337	131	083179	676	092355	721	096681	726	101514	771	111919	162
074344	131	083186	676	092393	724	096698	726	101552	731	111957	96
074702	444	083193	676	092409	724	096704	727	101606	97	112084	172
074726	444	083223	676	092416	725	096711	727	101613	97	112107	172
074740	310	083230	676	092423	725	096728	727	102047	121	112268	96
074900	412	083247	676	092430	725	096735	727	102054	121	112305	176
074917	412	083254	678	092447	725	097183	374	103112	141	112312	176
075150	218	086736	149	092751	225	097190	374	103136	141	112336	176
075181	218	086743	149	092782	225	097206	374	103174	177	112343	176
075211	421	086781	281	092836	394	097664	225	103204	411	112367	128
075389	320	086804	440	092850	89	097671	225	103242	184	112626	400
075402	320	087368	423	092881	89	098616	148	103266	284	112671	108
075419	320	087375	423	092911	202	098722	195	103273	284	112695	400
075471	408	087665	409	092942	89	098739	195	103723	98	112701	124
075488	501	087702	184	093000	245	099057	387	103792	329	112718	108
075495	185	087719	184	093024	151	099064	387	103983	178	112732	124
075501	185	087757	418	093048	199	099101	181	103990	138	113302	107
075518	185	087764	214	093062	199	100272	224	104928	70	113319	107
075525	451	087771	214	093079	245	100289	224	104935	70	113678	229
075532	451	087818	170	093086	414	100326	118	104942	70	113753	718
077734	466	087863	318	093093	318	100333	118	105628	184	113760	718
077741	466	087870	318	093475	329	100364	721	105659	485	113791	719
077758	466	087924	151	093505	307	100371	721	105710	359	113975	240
077765	504	087979	193	093512	307	100388	712	105727	359	113982	678
077796	325	088013	193	093659	121	100395	712	105734	359	113999	678
077802	325	088020	193	093697	121	100746	319	106175	761	114019	678
077819	325	088051	211	093963	282	100784	319	106182	761	114170	212
080291	323	088068	211	093994	233	100791	319	106205	780	114187	212
080338	323	088266	347	094007	233	100807	319	107691	679	114194	212
080345	323	088273	347	094014	282	100883	150	107707	679	114262	98
080352	323	088921	172	094045	228	100913	150	108094	436	114279	205
080932	325	088938	172	094120	228	100937	150	108117	436	114293	718
081434	273	089485	327	094137	162	100944	150	108292	812	114347	766
081441	273	089560	387	094182	357	100951	150	108407	781	114361	97
081502	212	089577	387	094229	162	101095	138	109138	758	114620	462

Indice per codice

SKU	Pag	120218	778	123981	658	132778	484	138886	740	142913	75
		120249	796	123998	658	133270	403	138893	740	142999	763
114675	329	120287	797	124001	658	133300	403	138978	676	143156	409
114682	329	120317	796	124018	658	133393	307	138985	676	143200	818
114729	205	120324	796	124025	658	133874	178	139012	674	143217	818
114736	205	120362	797	124070	814	133881	178	139029	674	143224	818
114743	205	120386	796	124087	814	134789	349	139098	117	144238	686
114811	97	120423	731	124100	814	134796	349	139425	106	144245	686
115061	750	120430	731	124117	814	134826	242	139432	106	144252	686
115078	750	120454	771	124124	566	134833	242	139470	754	144276	709
115085	750	120898	176	124131	566	134840	242	139685	107	144283	708
115092	750	120904	176	124155	566	134871	119	140179	287	144917	372
115108	750	121130	370	124162	412	134888	272	140186	287	145020	768
115115	750	121147	370	124179	412	134895	272	140193	287	145068	768
115290	716	121154	370	124421	754	134901	272	140230	151	145198	438
115306	716	121161	370	125503	317	135205	755	140339	233	145204	438
115313	716	121178	370	125510	317	135250	692	140599	419	145211	438
115320	716	121338	370	125565	317	135526	804	140605	226	145228	729
115337	716	121352	377	125824	119	135755	763	140612	226	145303	701
115344	716	121406	493	125831	119	135762	763	140629	226	145310	779
115351	720	121437	493	125886	342	135908	761	140711	154	145327	701
115368	720	121963	709	125923	342	135922	761	140728	154	145334	779
115375	720	121970	784	126531	566	135991	684	140759	154	145341	701
115382	733	122014	799	126548	566	136004	684	140827	239	145358	779
115412	781	122021	799	126883	356	136011	684	140841	293	146775	729
115429	781	122045	733	126890	356	136028	757	140872	293	146782	729
115481	384	122083	106	126906	73	136035	757	140902	293	146799	729
115498	240	122106	106	126913	73	136042	757	140933	293	147642	432
115504	240	122168	810	128207	460	136059	757	141046	418	147659	432
115511	420	122205	284	128832	818	136073	686	141053	214	147666	658
115580	680	122212	284	128849	818	136318	169	141060	214	147673	658
115597	680	122236	184	129082	110	136325	169	141268	354	147680	658
115610	680	122243	184	129099	110	136332	125	141275	354	147765	710
115801	96	122557	177	129433	714	136349	125	141794	70	147772	710
115962	422	122564	177	129440	714	136707	308	141800	70	147796	710
115979	238	122663	689	129457	714	136714	308	141817	70	147819	710
115986	238	122687	689	129464	703	136882	356	141855	70	148151	102
116006	238	122717	387	129471	703	136899	356	141893	169	148175	102
116099	272	122731	304	129488	703	136905	356	141909	169	148502	102
116112	277	122748	304	129495	690	136936	73	141923	239	148847	686
116228	202	122823	816	129501	690	137032	69	142050	387	148854	686
116235	202	122830	816	129518	690	137056	69	142067	304	148861	686
116457	109	122854	816	129570	458	137391	711	142081	387	148878	686
116464	109	122861	816	129600	241	137407	711	142098	304	148908	391
116570	443	122878	464	129709	206	137681	117	142197	272	148939	492
116587	443	122885	464	129860	804	137827	493	142203	272	149561	161
116716	768	122984	387	129877	804	138237	78	142241	379	149585	162
117652	812	123080	709	129921	206	138251	350	142258	379	149592	162
117737	198	123295	816	130163	804	138275	98	142265	367	149622	307
117867	343	123301	816	130170	804	138305	161	142272	367	149738	717
117881	794	123745	723	130187	804	138343	239	142289	367	149745	717
118659	706	123769	723	130903	243	138374	391	142296	367	150116	674
118666	709	123776	723	130910	243	138510	763	142302	717	150130	674
119427	390	123783	723	131788	246	138596	268	142579	379	150284	673
119465	390	123882	804	131795	246	138602	268	142586	379	150291	674
119502	390	123899	804	131924	151	138619	268	142616	502	150307	674
119571	804	123936	811	131962	349	138633	270	142692	376	150420	294
119786	387	123943	812	132365	140	138640	270	142708	376	150437	294
120201	778	123974	658	132389	140	138657	270	142906	75	150468	294

150475	294	156408	388	161846	690	168357	171	177199	500	189031	812
150581	343	156682	75	161853	690	168364	171	177205	500	189062	812
150635	72	156699	75	162201	94	168753	216	179292	353	189093	811
150673	72	156705	384	162478	94	168777	216	179308	353	189109	811
151649	802	156712	300	162492	764	168852	245	179315	353	189147	804
151656	802	156729	384	162737	207	168869	245	179322	353	189154	804
151663	802	156736	384	162751	207	168906	229	179643	401	189161	804
151687	804	156743	384	163109	106	168913	415	179681	366	189505	584
151694	804	156774	300	163123	106	168920	331	179858	168	189529	584
151700	804	156781	300	163154	106	168937	331	180045	717	189536	584
151717	804	157580	804	163161	106	168951	247	180298	389	189543	584
151724	804	157597	804	163321	393	168968	247	180304	389	189574	584
151731	802	157856	751	163338	393	169118	355	180922	241	189581	584
151748	802	158242	410	163369	476	169576	612	180946	492	189598	584
151755	804	158723	70	163536	721	169583	612	180953	746	189604	584
151762	804	158815	83	163543	721	169590	612	182179	190	189611	584
151779	804	158822	721	163550	721	169606	612	183794	812	189628	584
151786	804	158860	83	163598	722	169613	612	186795	83	189635	584
151793	802	158891	764	163604	712	169620	612	186801	83	189642	584
151861	804	158907	728	163611	712	169637	612	186955	764	189659	584
151946	802	159010	311	163628	712	169644	612	186979	764	189666	584
151953	802	159256	249	163635	712	169705	612	186986	672	189673	584
151960	804	159423	366	163642	689	169712	612	186993	672	189680	584
151977	804	159508	366	163666	689	169729	612	187006	396	189697	584
151991	804	159522	366	163727	780	169736	612	187327	751	189703	584
152004	804	159638	316	163741	758	169972	612	187341	717	189710	584
152776	247	159645	316	163758	758	169989	612	187358	717	189727	584
152851	411	159812	249	163789	176	170145	612	187365	347	189734	584
152875	285	159836	693	164823	357	170152	612	187525	767	189741	584
152899	285	159843	104	164847	357	170589	70	187532	767	189758	584
152912	285	159850	104	164878	75	170923	347	187549	767	189765	584
153001	814	159867	104	164953	222	172408	707	187556	767	189772	584
153162	752	159942	230	164960	222	172439	762	187662	75	189789	584
153179	752	159959	230	164977	201	172804	317	187877	765	189796	584
153193	752	159973	230	164984	201	172828	317	187884	765	189802	584
153209	752	159980	230	164991	319	173245	78	187891	765	189819	584
153438	125	159997	388	165004	319	173252	350	187976	612	189826	584
153445	125	160016	388	165011	190	174204	141	187983	612	189833	584
153926	802	160085	247	166247	198	174211	141	187990	612	189840	584
153933	802	160214	398	166285	330	174228	141	188003	612	189857	584
153940	802	160245	398	166322	197	174235	141	188010	612	189864	584
153957	804	160269	86	166360	197	174396	180	188027	612	189871	584
153964	804	160313	308	166544	224	174402	180	188058	612	189888	584
153971	804	160856	159	166551	224	174792	383	188065	612	189895	584
153988	804	160863	159	166889	213	174808	383	188072	612	189901	584
154008	811	161327	154	167121	385	174822	383	188089	612	189918	584
155142	299	161334	154	167152	385	174846	383	188096	612	189925	584
155227	299	161365	159	167244	220	174921	311	188102	612	189932	584
155722	673	161372	159	167251	220	174976	311	188119	612	189949	584
155791	295	161389	159	167268	220	175768	275	188126	612	189956	584
155869	295	161648	182	167398	220	175799	275	188195	612	189963	584
155968	99	161662	182	167404	220	175973	153	188911	802	189970	584
156026	99	161686	450	167411	220	176000	153	188928	802	189987	584
156033	99	161716	498	167497	102	176031	153	188935	802	189994	584
156316	99	161754	745	168036	691	176062	153	188942	804	190006	584
156323	99	161761	745	168050	691	176352	243	188959	804	190013	584
156330	99	161778	745	168111	691	176369	243	188966	804	190020	584
156347	99	161785	348	168135	691	176536	382	188973	804	190037	584
156392	388	161792	348	168326	171	176550	382	188980	810	190044	584



Indice per codice

SKU	Pag	192598	542	196688	386	200378	398	206011	292	211701	72
		192604	542	196695	386	200385	398	206028	292	211718	72
190051	584	192611	542	196701	301	200392	305	206035	292	211763	626
190068	584	192628	542	196718	301	200408	305	206042	292	211770	626
190075	584	192635	542	196770	112	200484	306	206196	666	211787	626
190082	584	192642	542	196787	112	200491	165	206202	666	211794	626
190099	584	192659	542	196794	112	200880	102	206219	666	211800	626
190105	584	192666	542	196800	112	200897	102	206226	666	211817	626
190181	584	192673	542	196985	82	200903	102	206233	666	211824	626
190259	584	192680	542	196992	82	200996	329	206240	666	211831	626
191171	542	192697	542	197302	92	201016	329	206387	80	211848	626
191188	542	192703	542	197319	92	201023	415	206394	80	211855	626
191416	542	192710	542	197326	92	201054	410	206622	237	211862	626
191423	542	192727	542	197333	92	201078	450	206639	237	211879	626
191430	542	192734	542	197500	235	201085	499	206806	105	211886	626
191447	542	192741	542	197524	235	201092	410	206820	105	211893	626
191454	542	192758	542	197654	179	201115	450	206875	105	212623	798
191461	542	193359	652	197661	179	201122	499	207155	415	212647	798
191478	542	193366	652	197708	417	201252	804	207162	329	213071	763
191485	542	193373	652	197715	208	201269	804	207186	329	213088	763
191492	542	193380	652	197722	208	201276	804	207216	204	213095	702
191508	542	193403	652	197739	208	201283	804	207483	215	213101	754
191577	744	193410	652	197746	208	201290	804	207582	490	213194	685
191584	744	193427	652	197753	467	201382	459	207599	490	213200	685
191607	744	193434	652	197920	160	201399	459	207834	87	213217	724
191614	743	193458	652	198095	134	202396	634	207841	87	213262	750
191621	743	193465	652	198125	88	202921	692	207858	87	213279	750
191638	743	193472	652	198132	314	202945	692	208152	191	213323	718
191980	542	193489	652	198149	314	203072	566	208398	164	213330	720
191997	542	193519	652	198156	314	203089	566	208497	191	213347	716
192277	634	193526	652	198620	760	203102	566	208541	626	213354	716
192284	634	193533	652	198637	760	203119	566	208558	626	213361	757
192291	634	193540	652	198644	760	203126	566	208565	626	213484	230
192307	634	193946	437	199375	231	203133	661	208572	626	213491	415
192314	634	193991	437	199382	231	203140	661	208589	626	213507	331
192321	634	194172	75	199405	231	203171	374	208596	626	213521	198
192338	634	194189	75	199412	231	203188	374	208640	626	213569	330
192345	634	194196	75	199870	369	203195	374	208657	626	213583	197
192352	634	194202	75	199894	369	204468	804	208664	626	214009	742
192376	634	194257	612	199917	369	204475	804	208671	626	214474	148
192383	634	194295	102	199931	369	204581	566	208688	626	214481	148
192406	634	194301	612	199993	196	204598	566	208695	626	214498	280
192420	542	194677	115	200002	196	204611	566	208701	626	214504	280
192437	542	194684	115	200064	196	204628	566	208718	626	214511	280
192444	542	194806	70	200071	196	204635	566	208725	626	214672	355
192451	542	195483	742	200118	93	204888	434	208732	626	214689	355
192468	542	195490	742	200125	93	204895	434	208749	626	214696	355
192475	542	195506	742	200132	399	204949	481	208794	402	215693	411
192482	542	195704	340	200149	399	204956	481	208817	85	215709	411
192499	542	195711	340	200194	302	205281	101	209036	810	215747	275
192505	542	195728	340	200200	302	205298	101	209043	810	215761	275
192512	542	195735	340	200217	302	205304	101	209845	705	215778	275
192529	542	195742	340	200231	302	205311	101	209852	705	215785	275
192536	542	195759	340	200248	302	205939	741	209906	749	215969	204
192543	542	195766	340	200255	302	205946	741	211381	63	216027	626
192550	542	195773	340	200330	398	205977	292	211398	63	216263	626
192567	542	196190	276	200347	398	205984	292	211404	63	216270	542
192574	542	196206	276	200354	305	205991	292	211459	72	216287	542
192581	542	196220	276	200361	305	206004	292	211466	72	216317	626

216324	626	222868	795	225005	368	231563	114	238173	120	243986	662
216416	542	222875	795	225029	368	231570	114	238210	120	243993	662
216423	542	222882	508	225364	576	231587	114	238241	95	244013	662
217253	634	222899	508	226026	158	231594	114	238333	312	244181	664
218724	693	222912	508	226033	158	231600	114	238746	175	244198	664
218823	652	222929	508	226040	158	231631	603	238838	175	244204	664
218830	652	222936	508	226187	795	231662	603	238920	175	244235	816
218854	652	222943	508	226194	795	232041	117	238944	404	244242	816
219875	180	222950	508	226200	795	232331	476	238951	404	244259	816
220604	100	222967	508	226217	795	232362	476	238975	404	244549	814
220611	100	222974	508	226712	67	232409	476	239521	413	244556	814
220772	652	222981	508	226729	67	232485	446	239545	413	244563	814
220789	652	222998	508	226736	67	232508	446	239576	413	244570	814
220796	652	223001	508	226743	67	232546	446	239590	413	244587	814
220802	652	223018	508	226750	67	232690	112	239606	413	244594	814
220826	542	223025	508	227580	612	232713	112	239613	413	244600	676
221373	230	223032	508	227597	612	232720	112	240367	268	244624	84
221489	115	223049	508	227672	612	232744	112	240374	270	244648	84
221496	115	223056	508	227689	612	232966	298	241012	165	244662	296
221502	705	223063	508	227825	258	232980	298	241036	165	244808	644
221519	705	223070	508	227832	258	233017	298	241050	306	244822	644
221595	815	223087	508	229010	385	233031	298	241296	328	244846	644
221649	626	223094	508	229027	385	233062	290	241340	160	244853	644
221656	626	223124	508	229034	385	233079	290	241357	160	244884	289
221663	626	223131	508	229041	385	233192	290	241364	160	245041	776
221670	626	223148	508	229058	301	233215	290	241517	136	245072	776
221687	626	223155	508	229065	301	233321	290	241524	136	245089	776
221694	626	223162	508	229072	301	233352	290	241968	79	245096	776
222097	63	223179	508	229089	301	233666	351	241975	79	245102	776
222103	63	223186	266	229461	60	233765	291	241982	79	245331	455
222110	63	223193	266	229478	60	233772	291	241999	79	245348	455
222257	810	223209	266	229485	60	233826	291	242002	79	245393	455
222509	576	223216	266	229492	60	233833	291	242019	351	245669	63
222523	576	223223	266	229508	60	233840	351	242040	812	245676	63
222530	576	223230	266	229515	60	233970	291	242347	86	245683	63
222547	576	223254	67	229638	302	234007	291	242378	308	245690	63
222554	576	223285	508	229645	302	235455	68	242385	398	245706	63
222561	576	223292	508	229676	603	235486	68	242392	398	245713	63
222578	576	223704	566	229683	603	235516	68	242569	818	246390	664
222585	576	223711	566	229706	602	235547	68	242576	818	246413	576
222592	576	223728	566	229720	602	236841	712	242705	612	246437	576
222608	576	223735	566	229768	602	236858	712	243160	382	246444	576
222615	576	223742	566	229782	602	236865	689	243238	612	246451	612
222622	576	223759	566	229997	674	236957	81	243245	612	246468	612
222639	576	223766	566	230580	674	236964	81	243252	612	246499	612
222646	576	223834	804	230702	256	237251	804	243269	612	246505	612
222653	576	223919	804	230726	256	237398	174	243283	612	246512	612
222660	576	223926	804	231129	358	237428	174	243450	293	246529	612
222677	576	223933	804	231228	109	237442	174	243498	329	246536	612
222684	576	223940	804	231259	109	237497	174	243528	204	246543	612
222691	576	224275	508	231273	109	237510	174	243566	329	246550	612
222707	576	224367	812	231297	109	237664	103	243597	204	246567	612
222714	576	224541	135	231341	84	237671	103	243665	542	246574	612
222745	508	224633	431	231372	84	237794	200	243818	676	246581	612
222752	508	224640	431	231396	84	237800	200	243825	676	246598	612
222769	508	224930	368	231433	84	237930	382	243849	676	246604	612
222820	798	224954	368	231471	296	238104	120	243924	293	246611	612
222837	798	224985	368	231495	296	238128	454	243931	293	246628	612
222851	795	224992	368	231556	114	238135	120	243948	293	246796	693

Indice per codice

SKU	Pag	248189	662	249629	612	251981	640	255996	612	259154	60
		248196	662	249643	576	251998	640	256030	612	259161	60
246802	693	248257	758	249650	576	252018	640	256047	612	259178	60
246819	730	248264	758	249674	576	252025	677	256061	612	259185	60
246826	730	248271	758	249681	576	252032	677	256078	612	259192	60
246833	770	248288	758	249698	576	252049	677	256085	612	259208	60
246840	770	248295	758	249704	576	252056	677	256092	612	259222	447
246857	705	248370	662	249711	664	252186	804	256115	612	259239	70
246864	705	248387	776	249728	664	252209	804	256122	612	259260	290
246871	749	248394	776	249810	681	252551	811	256146	612	259277	290
246888	761	248479	444	249827	681	252568	811	256429	130	259345	341
246895	612	248486	444	249834	681	252599	288	256436	130	259352	341
246901	612	248530	289	250106	381	252605	288	256443	130	259376	522
246918	755	248554	174	250113	381	252612	288	256528	804	259413	522
246925	707	248592	662	250120	381	252629	288	257235	341	259765	406
246932	762	248608	662	250137	381	252971	626	257242	341	259772	406
246949	707	248615	776	250274	738	252988	626	257617	522	259796	406
246956	762	248783	650	250281	738	252995	626	257624	522	259802	406
246963	750	248790	650	250304	162	253008	626	257631	522	259819	406
246970	750	248950	650	250311	162	253015	626	257648	522	259826	406
246987	751	248967	650	250328	162	253381	810	257655	522	259833	406
246994	751	248974	650	250335	162	253398	812	257662	522	259857	406
247007	612	248981	650	250342	162	253404	811	257686	522	259864	456
247045	781	248998	650	250359	162	253411	802	257709	522	259871	456
247083	717	249001	650	250403	592	253428	804	257716	522	259895	456
247144	799	249018	650	250410	592	253435	804	257730	522	259901	456
247151	799	249025	650	250427	592	253442	804	257747	522	259918	456
247168	701	249032	650	250434	592	253459	804	257792	522	259925	456
247175	779	249049	650	250441	592	253466	812	257792	522	259949	456
247182	700	249056	120	250458	592	253473	810	257815	522	259956	456
247199	778	249063	120	250816	753	253480	811	257822	522	259963	496
247229	56	249070	120	250823	753	253497	812	257839	522	259970	496
247236	56	249087	120	250854	733	253558	576	257846	522	259970	496
247243	56	249162	818	250878	739	253558	576	257877	522	259994	496
247250	56	249179	818	250878	739	253589	64	257990	522	260006	496
247267	56	249186	818	250885	739	253596	64	258003	522	260013	188
247274	56	249193	818	250946	719	253664	58	258027	522	260020	188
247281	56	249193	818	250953	756	253671	58	258140	522	260044	188
247298	183	249209	818	250977	756	253688	259	258157	522	260051	188
247304	183	249216	818	250991	704	253695	339	258171	522	260068	456
247618	612	249223	818	251004	704	253886	814	258232	522	260075	456
247625	612	249230	818	251011	704	253893	814	258249	522	260082	456
247632	612	249247	818	251028	704	254272	260	258256	522	260136	496
247649	612	249254	818	251103	88	254319	748	258270	660	260235	496
247779	316	249261	816	251110	88	254326	717	258287	297	260242	496
247847	664	249278	816	251127	447	254388	748	258300	558	260327	406
247854	664	249285	816	251226	747	254944	508	258461	645	260334	406
247861	576	249292	816	251257	747	255019	256	258478	645	260341	406
247878	576	249308	816	251295	747	255514	789	258751	62	260358	406
247885	576	249315	816	251516	688	255521	789	258768	62	260433	456
247939	576	249322	818	251523	688	255651	793	258775	62	260440	456
247946	576	249339	818	251530	688	255668	793	258874	474	260457	496
247953	576	249452	768	251547	688	255682	793	258881	433	260464	496
247960	576	249469	768	251554	688	255781	790	258898	77	260471	188
247977	576	249476	768	251561	688	255804	790	258904	474	260488	188
247984	576	249483	768	251578	688	255859	785	258911	433	260600	378
247991	576	249490	768	251592	688	255866	785	258928	77	260617	378
248165	662	249506	768	251943	640	255934	274	259017	73	260624	378
248172	662	249513	768	251950	640	255941	274	259048	405	260631	378
		249520	768	251967	640	255989	348	259062	405	260648	378

260655	378	266534	646	267746	566	269146	705	270180	552	271422	91
260662	378	266541	646	267760	348	269153	707	270197	552	271439	397
260679	378	266558	646	267777	592	269160	762	270203	552	271446	592
260853	522	266565	646	267784	592	269184	717	270210	552	271453	592
260860	522	266572	646	267791	592	269207	717	270241	260	271514	747
261164	278	266589	646	267807	592	269214	717	270258	260	271538	297
261188	278	266596	646	267821	289	269221	719	270265	260	271545	297
261195	168	266602	646	267838	289	269238	747	270272	260	271576	738
261287	782	266619	646	267869	666	269245	747	270289	260	271590	804
261294	782	266626	646	267876	666	269252	747	270296	260	271606	804
261331	774	266633	646	267883	666	269269	747	270302	260	271613	804
261355	774	266657	646	267890	666	269276	747	270319	260	271620	802
261362	774	266671	646	267906	666	269290	784	270326	260	271637	804
261379	774	266688	646	267913	666	269313	717	270333	260	271644	802
261409	790	266701	646	267920	662	269320	717	270340	260	271712	552
261508	689	266725	646	267937	662	269337	64	270357	260	271750	552
261522	689	266732	646	267944	662	269351	64	270364	260	271880	338
262369	542	266756	811	267951	662	269375	64	270371	260	271897	338
262376	542	266763	811	267968	634	269382	64	270388	260	272030	375
263434	74	266770	811	267975	634	269399	339	270395	260	272078	434
263441	74	267128	552	267982	666	269405	339	270401	260	272085	481
263519	283	267135	552	267999	666	269412	259	270449	560	272108	774
263632	136	267142	552	268002	666	269429	259	270456	560	272139	158
263649	136	267159	552	268071	351	269436	58	270463	560	272238	448
263656	136	267203	522	268088	660	269443	58	270470	560	272245	491
263663	74	267210	522	268095	351	269450	58	270487	560	272375	811
263670	74	267227	522	268101	297	269467	58	270494	560	272382	811
263687	74	267234	522	268118	79	269474	430	270500	560	272429	816
263700	74	267241	522	268149	79	269481	430	270517	560	272436	816
264509	143	267258	522	268156	782	269498	430	270524	560	272443	816
264523	143	267265	566	268163	782	269504	799	270531	560	272450	816
264547	143	267272	566	268170	782	269597	602	270548	560	272467	816
265278	437	267289	566	268187	782	269634	602	270586	260	272474	814
265285	437	267296	566	268194	782	269696	799	270593	260	272481	814
265292	482	267302	566	268200	782	269702	799	270661	256	272498	814
265308	482	267319	566	268217	79	269719	799	270678	256	272504	814
265315	483	267326	566	268224	790	269726	799	270692	542	272511	814
265322	483	267333	566	268231	79	269733	799	270715	260	272528	814
265575	364	267340	566	268293	719	269740	689	270845	747	272535	814
265643	364	267357	566	268309	719	269757	689	270876	542	272542	814
265896	522	267364	566	268316	719	269764	689	270883	542	273167	634
265957	60	267371	566	268347	733	269771	689	270920	804	273174	634
265971	254	267388	566	268354	733	269795	183	270937	542	273631	309
265988	254	267395	566	268361	733	269825	256	270944	802	273648	90
265995	254	267401	566	268422	748	269832	56	270951	804	273655	395
266008	254	267418	566	268439	748	269849	56	270968	810	273662	472
266015	254	267425	566	268989	789	269856	60	270975	812	273679	446
266022	254	267432	566	268996	789	269863	60	271002	260	273693	313
266121	522	267449	566	269009	788	269870	60	271125	560	273709	313
266145	522	267456	566	269016	788	269986	406	271187	556	273914	352
266183	522	267463	566	269023	788	270005	456	271194	556	273945	352
266251	812	267470	566	269030	788	270012	496	271200	556	274768	642
266282	810	267487	566	269061	704	270029	188	271217	556	274775	642
266299	812	267494	566	269078	704	270036	406	271293	137	274782	642
266305	812	267500	566	269092	704	270043	188	271309	137	275369	77
266497	646	267692	664	269108	704	270050	188	271316	137	275376	77
266503	646	267715	566	269115	692	270104	810	271385	91	275383	77
266510	646	267722	566	269122	692	270111	810	271392	91	275543	173
266527	646	267739	566	269139	705	270173	552	271408	91	275567	173

Indice per codice

SKU	Pag	281988	508	283258	604	285306	352	285894	818	287072	353
		281995	508	283524	604	285313	352	285900	818	287799	304
275581	173	282008	522	283531	604	285320	375	285917	818	287805	304
276182	600	282015	522	283548	604	285337	477	285924	818	287812	304
276205	788	282022	522	283555	604	285344	477	285993	522	287829	387
276212	785	282039	522	283562	604	285351	592	286006	522	287836	387
276243	600	282046	522	283579	604	285368	592	286051	522	287843	620
276267	604	282053	522	283586	604	285375	592	286068	522	287850	620
276274	604	282084	491	283593	604	285382	592	286075	522	287867	620
276281	604	282091	448	283609	604	285399	592	286082	522	287874	620
276304	552	282121	353	283616	604	285405	592	286099	522	287881	620
276311	552	282138	353	283623	604	285412	634	286105	522	287898	620
276328	522	282633	522	283630	604	285429	634	286112	522	287904	620
276335	542	282640	522	283647	604	285436	634	286129	522	287911	620
276342	542	282657	522	283654	604	285443	634	286150	522	287928	620
276366	508	282664	522	283661	604	285450	698	286167	522	287935	620
276489	738	282671	522	283678	604	285467	698	286174	522	287942	620
276526	785	282688	522	283685	604	285474	698	286181	522	287959	814
276564	66	282695	522	283692	604	285481	698	286198	522	287966	814
276571	66	282701	522	283708	604	285498	698	286204	522	288147	620
276588	66	282718	522	283715	604	285504	698	286211	522	288208	810
276595	66	282725	522	283722	604	285511	699	286228	522	288215	810
276601	66	282749	522	283739	604	285528	699	286235	522	288222	812
276618	66	282756	522	283746	604	285535	699	286242	522	288239	812
276625	66	282770	522	283753	604	285542	753	286259	522	288338	522
276632	66	282787	522	283760	604	285559	753	286266	522	288345	810
277004	792	282794	522	283777	604	285566	812	286273	522	288383	811
277011	792	282800	522	283784	397	285573	812	286280	522	288543	812
277028	792	282824	522	283791	91	285580	816	286297	522	288611	346
277035	792	282831	522	283807	91	285597	816	286303	522	288628	346
277219	353	282848	522	283814	91	285603	816	286310	522	289212	802
277226	353	282855	522	283821	91	285610	816	286327	522	289229	802
277233	353	282862	522	284729	346	285627	816	286334	522	289236	804
277240	353	282879	522	285009	387	285634	816	286341	522	289243	804
277257	353	282886	522	285016	387	285641	816	286358	522	289250	804
277417	295	282893	522	285061	60	285658	816	286365	522	289281	522
277912	542	282909	522	285078	60	285665	816	286372	522	289298	522
277929	542	282916	522	285085	76	285672	816	286389	522	289304	522
278704	295	282923	522	285092	76	285689	816	286396	522		
279596	620	282930	522	285108	364	285696	816	286402	522		
279602	620	282947	522	285115	364	285702	816	286419	522		
279626	620	282954	522	285122	113	285719	816	286426	522		
279633	620	282961	522	285139	116	285726	816	286433	522		
279640	620	282978	522	285146	116	285733	816	286440	522		
279671	620	282985	522	285153	116	285740	816	286457	522		
279688	620	282992	522	285160	116	285757	816	286464	522		
279695	620	283005	522	285177	143	285764	816	286471	522		
279701	620	283012	522	285184	143	285771	816	286488	522		
279718	620	283029	522	285191	143	285788	816	286495	522		
279725	620	283036	522	285207	283	285795	816	286501	522		
279770	113	283043	522	285214	290	285801	816	286518	522		
279794	113	283050	604	285221	291	285818	816	286525	522		
279800	477	283067	604	285238	295	285825	816	286532	522		
280233	620	283104	522	285245	313	285832	816	286549	522		
280240	620	283111	522	285252	313	285849	816	286594	600		
280998	380	283142	508	285269	338	285856	816	286600	600		
281001	380	283173	508	285276	338	285863	816	286662	486		
281568	116	283180	508	285283	352	285870	816	286679	486		
281582	116	283197	508	285290	352	285887	818	286686	486		

Icone tecniche



Classe I Sicurezza elettrica garantita dall'isolamento principale e da un conduttore di protezione (messa a terra) collegato alla struttura metallica della lampada. Messa a terra obbligatoria.



Classe II Sicurezza elettrica garantita dall'isolamento principale e da un doppio isolamento o da un isolamento rinforzato. Non deve avere messa a terra.



Classe III Sicurezza elettrica garantita dall'alimentazione a bassissima tensione (inferiore a 50 Volt). Non deve avere messa a terra.



Apparecchio non idoneo al montaggio diretto o incasso su superfici normalmente infiammabili.



Marchio di conformità alle direttive comunitarie europee di sicurezza.

Simboli



Lampadina inclusa.



Articoli con lampade a LED: consumo estremamente ridotto, luce chiara e concentrata, robustezza e lunga durata.



Interruttore integrato nel corpo luce.



Apparecchio dotato di interruttore touch: si accende e si regola l'intensità col tocco di un dito sul corpo luce.



Apparecchio fornito con variatore di potenza.



Lampada con presa USB integrata.



Luce indiretta inclusa.



Prodotto ad alto contenuto tecnologico, elevata qualità dei materiali, destinato ad uso professionale.



Articolo con UGR.



Articolo adatto alla pittura e verniciatura.



Grado di protezione.



Articolo in acciaio inox 316.



Lampada con rilevazione di presenza inclusa PIR (Passive InfraRed).



Lampada con batteria ricaricabile inclusa.

Note

-I prezzi indicati sono riferiti al pubblico IVA esclusa.

-Ideal lux S.R.L. si riserva il diritto di apportare, in qualunque momento e senza preavviso, tutte le modifiche necessarie a migliorare la qualità degli articoli illustrati nel presente catalogo.

-I nostri prodotti in classe I e II si alimentano con tensione nominale di 220-240 vac 50/60 hz. Tutti i nostri prodotti sono conformi alle direttive CE.

-Qualora acquistato separatamente come "optional", il driver dimmerabile sarà già incluso nel prodotto in sostituzione del driver standard on-off: verrà fornito un solo driver.

-I Watt indicati a catalogo esprimono la potenza NOMINALE dell'articolo comprensivo di sorgente e driver, quando inclusi. I valori riferiti ai lm relativi alle lampade con sorgenti integrate a LED, sono da considerarsi NOMINALI, riferiti cioè alla sorgente. Per i lm effettivi dei singoli apparecchi illuminanti si prega gentilmente di consultare le fotometrie.

-Il valore UGR non è una caratteristica dell'apparecchio, ma dell'installazione. Gli UGR riportati in questo catalogo sono stati calcolati tenendo conto di un'installazione ideale e sono raggruppati nei blocchi <10 <13 <16 <19 <22. Si consiglia di calcolare l'UGR specifico secondo la propria installazione.

-La durata di vita utile delle sorgenti LED di tutti gli articoli presenti a catalogo è riferita al valore L70B50, quando non dichiarato altrimenti.

Contatti

IDEAL LUX s.r.l.

Via Taglio Destro, 32
30035 Mirano – Venezia
P.I. / C.F. 02420040277
8.00 - 12.00 / 13.30 - 17.30

IDEAL LUX Warehouse

Via delle Industrie, 8/D
30036 Santa Maria di Sala – Venezia
8.00 - 12.00 / 13.30 - 17.00

E info@ideal-lux.com

T +39 041 5790500

F +39 041 8872349

© [ideal.lux](https://www.ideal-lux.com)

f [Ideal Lux](#)

www.ideal-lux.com

Community Design Pending Nr. 001996372 002022038 002194993 002621862 002943449 003734342 004558609 006083655

Copyright 2022 © IDEAL LUX S.r.l. – All rights reserved – Tutti i diritti sono riservati



ideal lux
www.ideal-lux.com

IDEAL LUX s.r.l.
Via Taglio Destro, 32
30035 Mirano — Venezia

IDEAL LUX Warehouse
Via delle Industrie, 8/D
30036 Santa Maria di Sala — Venezia

📍 ideal.lux
📘 Ideal Lux